



Carrer d'Osca, 11 (Polígono Las Salinas)
08830 Sant Boi de Llobregat
Barcelona (España)

(+34) 936 358 758

(+34) 608 299 107

www.movilfritofficial.com
pedidos@movilfritofficial.com

DESCUBRE NUESTRA NUEVA APP DISCOVER OUR NEW APP DÉCOUVREZ NOTRE NOUVELLE APP



ACCEDA A TODA LA INFORMACION TÉCNICA ACCESS ALL THE TECHNICAL INFORMATION ACCÉDER À TOUTES LES INFORMATIONS TECHNIQUES

Fichas técnicas, esquemas electricos, despieces, manuales de instrucciones, recambios con imágenes y mucho más.

Technical specifications, electric schemes, exploded views, manuals, spare parts with images and much more.

Spécifications techniques, schémas électriques, vues éclatées, manuels, pièces de rechange avec images et bien plus encore.

REALICE SU PEDIDO PLACE YOUR ORDER PASSER VOTRE COMMANDE

Al mandar el pedido recibe una copia para su control.

When sending the order you receive a copy for your control.

Lors de l'envoi de la commande, vous recevez une copie pour votre contrôle.

SIEMPRE AL DIA ALWAYS UP TO DATE TOUJOURS À JOUR

Productos y precios siempre actualizados.

Products and prices always updated.

Produits et prix toujours mis à jour.

OFERTAS OFFERS DES OFFRES

Acceso directo a ofertas de producto.

Direct access to product offers.

Accès direct aux offres produits.



Movilfrit
2023

FABRICADO EN ESPAÑA
MADE IN SPAIN
FABRIQUÉ EN ESPAGNE

NUESTRA EMPRESA

OUR COMPANY · NOTRE ENTREPRISE

Movilfrit

DISEÑO, FABRICACIÓN Y COMERCIALIZACIÓN DE MAQUINARIA DE CALIDAD PARA LA HOSTELERÍA

Desde nuestra fundación en 1962, hemos conseguido llegar hasta hoy diseñando, fabricando y comercializando productos especialmente pensados para dar respuesta a cualquier necesidad que pueda surgir entre los profesionales de la hostelería y de la restauración.

Grandes y medianas empresas e incluso particulares, disponen de nuestra garantía de puntualidad en sus pedidos, entregados en márgenes de tiempo de 48/72h y también en reparación y envío de recambios.

DESIGN, MANUFACTURE AND MARKETING OF QUALITY MACHINERY FOR THE HOSTELRY SECTOR

Since our foundation in 1962, we have managed to reach the present day by designing, manufacturing and marketing products specially designed to meet any need that may arise among professionals in the hotel and catering industry.

Large and medium-sized companies and even private individuals can count on our guarantee of punctuality in their orders, delivered within 48/72 hours and also in the repair and shipment of spare parts.

CONCEPTION, FABRICATION ET COMMERCIALISATION DE MACHINES DE QUALITÉ POUR L'INDUSTRIE HÔTELIÈRE

Depuis notre fondation en 1962, nous avons réussi à atteindre le jour d'aujourd'hui en concevant, fabriquant et commercialisant des produits spécialement conçus pour répondre à tous les besoins des professionnels de l'hôtellerie et de la restauration.

Les grandes et moyennes entreprises et même les particuliers peuvent compter sur notre garantie de ponctualité dans leurs commandes, livrées dans les 48/72 heures, ainsi que dans la réparation et l'envoi de pièces détachées.

SOMOS FABRICANTES

Todos nuestros productos están fabricados en España -Sant Boi de Llobregat (Barcelona)-, con la mejor tecnología, los mejores materiales y sin obsolescencia programada, ya que todos nuestros productos están diseñados para perdurar.

Vitrinas, planchas y freidoras con sistema agua-aceite -tecnología de la que somos pioneros- o freidoras de sólo aceite, se incluyen en nuestro amplio catálogo con diseños a medida y personalización total para nuestro cliente.

Llevamos 60 años ofreciendo soluciones en materia de equipamiento integral de cocina profesional. La tecnología aplicada a nuestros procesos, la exhaustiva selección de los mejores materiales, el alto grado de profesionalidad y la amplia experiencia de nuestro personal, son algunas de las claves que nos han llevado a ser considerados como referente en el sector, tanto a nivel nacional como internacional.

WE ARE MANUFACTURERS

All our products are manufactured in Spain -Sant Boi de Llobregat (Barcelona)-, with the best technology, the best materials and without programmed obsolescence, as all our products are designed to last.

Display cabinets, griddles and fryers with water-oil system - a technology in which we are pioneers - or oil-only fryers, are included in our extensive catalogue with customised designs and total personalisation for our customers.

We have been offering solutions for 60 years in terms of integral professional kitchen equipment. The technology applied to our processes, the exhaustive selection of the best materials, the high degree of professionalism and the extensive experience of our staff, are some of the keys that have led us to be considered as a reference in the sector, both nationally and internationally.

NOUS SOMMES DES FABRICANTS

Tous nos produits sont fabriqués en Espagne -Sant Boi de Llobregat (Barcelone)-, avec la meilleure technologie, les meilleurs matériaux et sans obsolescence programmée, car tous nos produits sont conçus pour durer.

Vitrines, grils et friteuses avec système eau-huile - une technologie dans laquelle nous sommes pionniers - ou friteuses uniquement à l'huile, font partie de notre vaste catalogue avec des designs sur mesure et une personnalisation totale pour nos clients.

Depuis 60 ans, nous proposons des solutions en matière d'équipement intégral de cuisine professionnelle. La technologie appliquée à nos processus, la sélection exhaustive des meilleurs matériaux, le haut degré de professionnalisme et la grande expérience de notre personnel, sont quelques-unes des clés qui nous ont permis d'être considérés comme une référence dans le secteur, tant au niveau national qu'international.

EVOLUCIÓN DEL LOGO
LOGO EVOLUTION
ÉVOLUTION DU LOGO

1962



2003



2014



2022



MOVILFRIT

CÓMO CONSEGUIR UN PRODUCTO ORIGINAL MOVILFRIT

HOW TO GET AN ORIGINAL MOVILFRIT

COMMENT OBTENIR UN PRODUIT MOVILFRIT ORIGINAL

La única manera de obtener nuestros productos originales es vía cualquiera de nuestros canales oficiales:

The only way to get our original products is through any of our official channels:

La seule façon d'obtenir notre produits originaux passe par l'un des nos chaînes officielles:

App: movilfritofficial

Web: movilfritofficial.com

Email: pedidos@movilfritofficial.com

Teléfono: 936 358 758

Móvil: 608 299 107



MATERIALES DE PRIMERA CALIDAD

Todas nuestras cestas estan construidas totalmente en ACERO INOXIDABLE.

All our baskets are made entirely of STEEL STAINLESS

Tous nos paniers sont entièrement en ACIER INOXYDABLE



PERSONALIZA TU PRODUCTO

Posibilidad de grabar con laser tu logotipo en nuestros productos sin ningún coste extra.

Possibility to laser engrave your logo on our products without any extra cost.

Possibilité de graver au laser votre logo sur nos produits sans frais supplémentaires.

FREIDORAS
FRYERS · FRITEUSES



VITRINAS
DISPLAY CASES · VITRINES



BRASA
CHARCOAL · BRAISE



MODULAR
MODULAR · MODULAR



PLANCHAS
GRIDDLES · PLANCHAS



COCINAS
KITCHENS · CUISINES



BARBACOAS
BARBACUE · BARBECUE



M. AUXILIAR
SMALL APPLIANCE · PETIT
APPAREIL



DOMÉSTICO
DOMESTIC · DOMESTIQUE



RECAMBIOS
SPARE PARTS · PIÈCES
DÉTACHÉES



FREIDDOORAS

FRYERS · FRITEUSES

ECONÓMICAS
ECONOMIC
ÉCONOMIQUE

ACEITE
OIL
HUILE

AGUA Y ACEITE
WATER AND OIL
EAU ET HUILE

GAS
GAS
GAZ

Sistema Agua & Aceite

WATER & OIL SYSTEM · SYSTÈME EAU&HUILE

SISTEMA ACEITE OIL SYSTEM SYSTÈME D'HUILE

En este tipo de freidora los residuos permanecen revoloteando por el aceite por lo que al freír distintos alimentos se mezclan los sabores y deben ser evacuados mediante su filtraje.

El atractivo de este sistema está en su sencillez, puesto que no se utiliza agua. Los restos de los alimentos se depositan en la parte inferior estando siempre en contacto con el aceite.

In this type of fryer, the residues remain fluttering through the oil, so when frying different foods, the flavors mix and must be evacuated by filtering.

The appeal of this system stays in his simplicity, since no water is used. The remains of the food are deposited in the lower part and always being in contact with the oil.

Dans ce type de friteuse, les résidus flottent toujours dans l'huile, de sorte que lorsque vous faites frire différents aliments, les saveurs se mélangent et doit être évacué par filtration.

L'attrait de ce système réside dans sa simplicité, puisqu'aucune eau n'est utilisée. Les restes de la nourriture sont déposés dans la partie inférieure, étant toujours en contact avec l'huile.

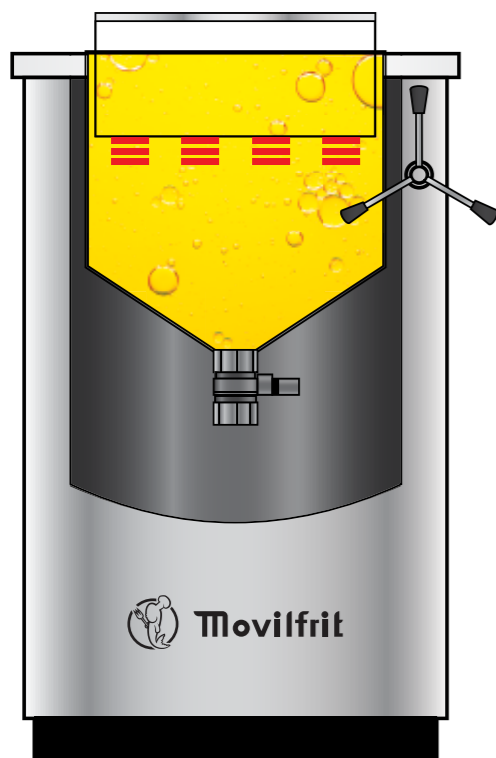

SISTEMA AGUA & ACEITE WATER & OIL SYSTEM SYSTÈME EAU & HUILE

En estas freidoras los restos de los alimentos que se desprenden durante la fritura atraviesan en el aceite y se depositan en la capa de agua en el fondo de la cuba. Estos residuos son evacuados conjuntamente con el agua. Esta operación se realizará diariamente con el aceite a temperatura ambiente.

En las freidoras que incorporan este sistema exclusivo el agua se deposita en la parte inferior de la cuba por diferencia de densidad haciendo de filtro permanente. De esta manera freímos distintos tipos de alimentos sin que la freidora mezcle sabores y conseguir un **gran ahorro de aceite**.

In these fryers, the remains of the food that come off during frying pass through the oil and are deposited in the layer of water at the bottom of the tank. These residues are evacuated with the water. This operation will be carried out daily with the oil at room temperature.

*In fryers that incorporate this exclusive system, the water is deposited in the lower part of the tank due to a difference in density, acting as a permanent filter. In this way we fry different types of food without the fryer mixing flavors and achieving **great savings in oil**.*

Dans ces friteuses, les restes d'aliments qui se détachent lors de la friture traversent l'huile et se déposent dans la couche d'eau au fond de la cuve. Ces résidus sont évacués avec l'eau. Cette opération sera effectuée quotidiennement avec l'huile à température ambiante.

*Dans les friteuses qui intègrent ce système exclusif, l'eau se dépose dans la partie inférieure du réservoir en raison d'une différence de densité, agissant comme un filtre permanent. De cette façon, nous faisons frire différents types d'aliments sans que la friteuse mélange les saveurs et réalisant de **grandes économies d'huile**.*

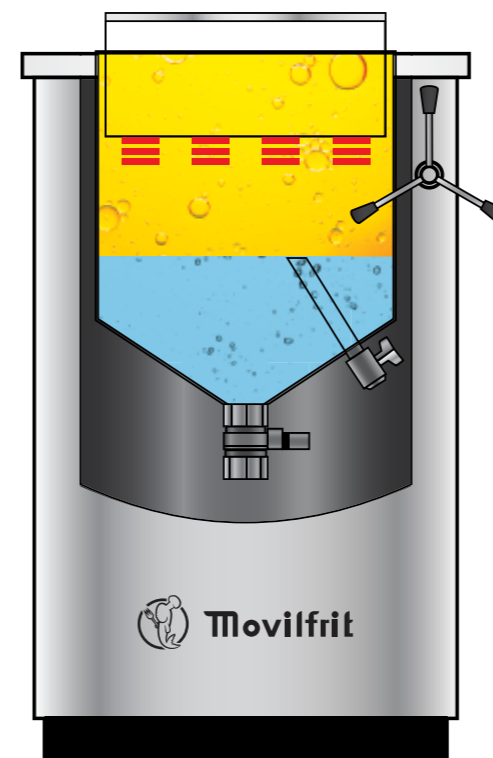

Resistencia Móvil o Fija

MOBILE OR FIXED RESISTANCE · MOBILE OU FIXE RÉSISTANCE

DIFERENCIA ENTRE RESISTENCIA MOVIL Y FIJA

En una freidora el calor necesario para la fritura de los alimentos es suministrado por la resistencia que calienta el aceite y este a su vez al alimento.

Si disponemos de una freidora con el elemento calefactor fijo, nos vemos en la necesidad de calentar todo el volumen de aceite que tenemos por encima de la resistencia. Igual ocurre con las freidoras con cesta movable.

Si disponemos de una freidora con el elemento calefactor móvil, al poder situar la resistencia a la altura deseada, nos encontramos con las siguientes ventajas:

- **Ahorro de energía:** Calentamos solamente el volumen necesario en cada cesta de fritura.
- **Mayor rapidez:** Con menor potencia tenemos una respuesta rápida, calentamos menor volumen de aceite y conseguimos mayor calidad de fritura.
- **Mayor duración aceite:** Al no calentar en cada fritura todo el volumen de aceite, este tiene mayor duración.

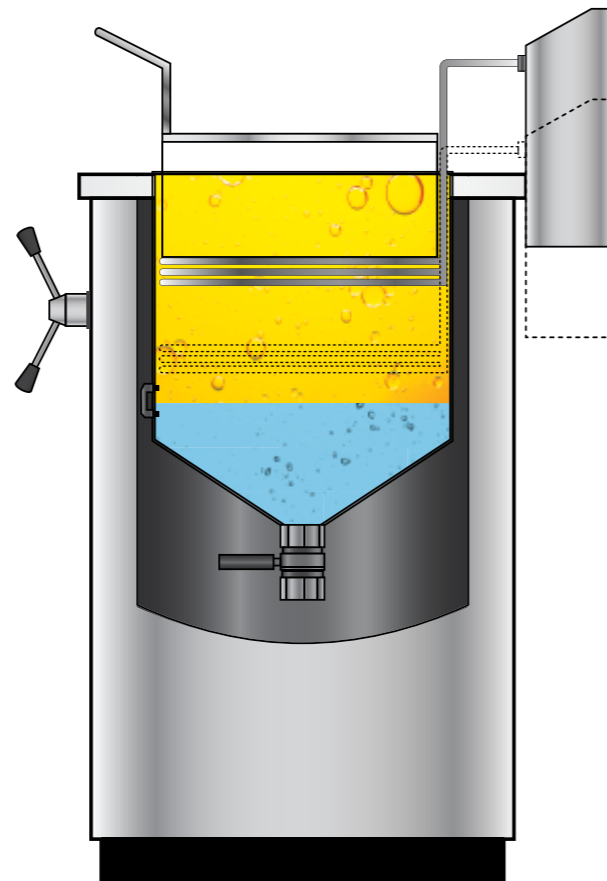

DIFFERENCE BETWEEN MOBILE AND FIXED RESISTANCE

In a fryer, the heat necessary for frying food is supplied by the resistance that heats the oil and this, in turn, heats the food.

If we have a fryer with a fixed heating element, we find ourselves in the need to heat the entire volume of oil that we have above the resistance. The same happens with fryers with a movable basket.

If we have a fryer with a mobile heating element, by being able to place the resistance at the desired height, we find the following advantages:

- **Energy saving:** We heat only the necessary volume in each frying basket.
- **Greater speed:** With less power we have a quicker response, we heat a smaller volume of oil and we achieve higher frying quality.
- **Longer oil life:** By not heating the entire volume of oil in each frying, it lasts longer.

DIFFÉRENCE ENTRE RÉSISTANCE MOBILE ET FIXE

Dans une friteuse, la chaleur nécessaire à la friture des aliments est fournie par la résistance qui chauffe l'huile et celle-ci, à son tour, chauffe les aliments.

Si nous avons une friteuse avec un élément chauffant fixe, nous nous retrouvons dans la nécessité de chauffer tout le volume d'huile que nous avons au-dessus de la résistance. La même chose se produit avec les friteuses à panier mobile.

Si nous avons une friteuse avec un élément chauffant mobile, en pouvant placer la résistance à la hauteur souhaitée, nous trouvons les avantages suivants :

- **Économie d'énergie:** Nous ne chauffons que le volume nécessaire dans chaque panier de friture.
- **Plus grande vitesse:** avec moins de puissance, nous avons une réponse plus rapide, nous chauffons un plus petit volume d'huile et nous obtenons une meilleure qualité de friture.
- **Durée de vie de l'huile plus longue:** en ne chauffant pas tout le volume d'huile à chaque friture, elle dure plus longtemps.

FA SG



CABEZAL ELÉCTRICO EXTRAÍBLE (LIMPIEZA FÁCIL)
 REMOVABLE ELECTRIC HEAD (EASY CLEANING)
 TÊTE ÉLECTRIQUE AMOVIBLE (NETTOYAGE FACILE)

TERMOSTATO SEGURIDAD
 SAFETY THERMOSTAT
 THERMOSTAT DE SÉCURITÉ

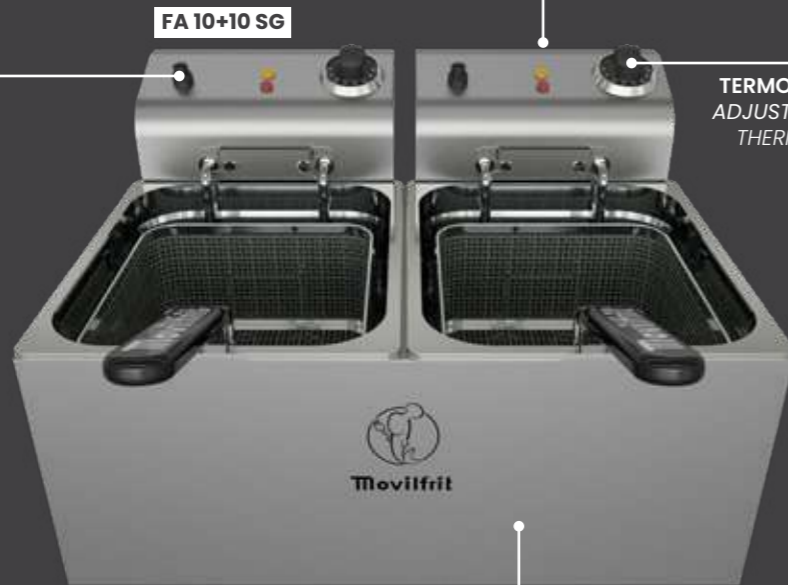

TERMOSTATO TRABAJO REGULABLE
 ADJUSTABLE WORKING THERMOSTAT
 THERMOSTAT DE TRAVAIL RÉGLABLE

PATAS ANTIDESLIZANTES
 NON-SLIP LEGS
 PIEDS ANTIDÉRAPANTS

CONSTRUIDA EN ACERO INOXIDABLE AISI304
 BUILT IN AISI304 STAINLESS STEEL
 CONSTRUIT EN ACIER INOXYDABLE AISI304

ACCESORIOS NO INCLUIDOS



Ref. 907039
 CESTA REFORZADA FA 4 100,15 €

Ref. 907037
 CESTA REFORZADA FA 6 102,69 €

Ref. 907045
 CESTA REFORZADA FA 8/10 111,77 €



Ref. 901101
 FILTRO RESIDUOS FA 6 35,02 €

Ref. 901100
 FILTRO RESIDUOS FA 8/10 35,02 €

FREIDORAS ECONOMICAS ACEITE SIN GRIFO CABEZAL FIJO-EXTRAIBLE ECONOMIC OIL FRYERS WITHOUT TAP WITH FIXED-REMOVABLE HEAD FRITEUSES À HUILE ÉCONOMIQUES SANS ROBINET À TÊTE FIXE-AMOVIBLE



FA 10+10 MAX 400 SG



FA 8 SG



FA 8+8 SG



Modelo	Código	Dimensiones L x P x H (mm)	Potencia W	Voltaje V	Capacidad L	Cesta L x P x H (mm)	Grifo	Peso kg	Precio €
FA 4 SG	157399	180X425X282	2	230	4	120X240X85	NO	4	302
FA 4+4 SG	857398	360X425X282	2+2	230	4+4	120X240X85	NO	7	573
FA 6 SG	157400	265X420X335	3	230	6	210X235X95	NO	6,5	305
FA 6+6 SG	157401	530X420X335	3+3	230	6+6	210X235X95	NO	12	567
FA 8 SG	157410	265X420X335	4	230	8	210X235X110	NO	7	367
FA 8+8 SG	157411	530X420X335	4+4	230	8+8	210X235X110	NO	12	683
FA 10 SG	157500	265X420X335	4	230	9	210X235X110	NO	7,5	367
FA 10+10 SG	157501	530X420X335	4+4	230	9+9	210X235X110	NO	13	683
FA 8 MAX 230 SG	NEW 157600	265X420X335	6	230	8	210X235X110	NO	8	766
FA 8+8 MAX 230 SG	NEW 157601	530X420X335	6+6	230	8+8	210X235X110	NO	13	1.450
FA 8 MAX 400 SG	NEW 157602	265X420X335	6	400	8	210X235X110	NO	8	820
FA 8+8 MAX 400 SG	NEW 157603	530X420X335	6+6	400	8+8	210X235X110	NO	13	1.557
FA 10 MAX 230 SG	157502	265X430X335	6	230	9	210X235X110	NO	8	766
FA 10+10 MAX 230 SG	157503	530X430X335	6+6	230	9+9	210X235X110	NO	13	1.450
FA 10 MAX 400 SG	NEW 157604	265X430X335	9	400	9	210X235X110	NO	8,5	845
FA 10+10 MAX 400 SG	NEW 157605	530X430X335	9+9	400	9+9	210X235X110	NO	13,5	1.582



TERMOSTATO TRABAJO REGULABLE
ADJUSTABLE WORKING THERMOSTAT
THERMOSTAT DE TRAVAIL RÉGLABLE

FA 10 CG

TERMOSTATO SEGURIDAD
SAFETY THERMOSTAT
THERMOSTAT DE SÉCURITÉ

CABEZAL ELÉCTRICO EXTRAÍBLE (LIMPIEZA FÁCIL)
REMOVABLE ELECTRIC HEAD (EASY CLEANING)
TÊTE ÉLECTRIQUE AMOVIBLE (NETTOYAGE FACILE)

PATAS ANTIDESLIZANTES
NON-SLIP LEGS
PIEDS ANTIDÉRAPANTS

CONSTRUIDA EN ACERO INOXIDABLE AISI304
BUILT IN AISI304 STAINLESS STEEL
CONSTRUIT EN ACIER INOXYDABLE AISI304

GRIFO INCORPORADO PARA EVACUAR ACEITE
BUILT-IN TAP TO DRAIN OIL
ROBINET INTÉGRÉ POUR VIDANGER L'UILE

ACCESORIOS NO INCLUIDOS



Ref. 907037
CESTA REFORZADA FA 6 102,69 €

Ref. 907045
CESTA REFORZADA FA 8/10 111,77 €

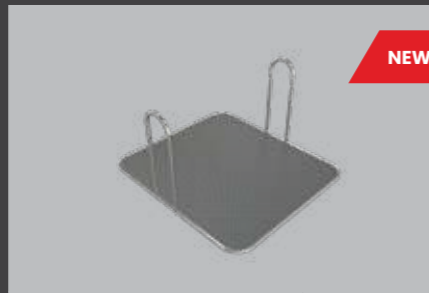

Ref. 901101
FILTRO RESIDUOS FA 6 35,02 €

Ref. 901100
FILTRO RESIDUOS FA 8/10 35,02 €

FREIDORAS ECONOMICAS ACEITE CON GRIFO CABEZAL FIJO-EXTRAIBLE ECONOMIC OIL FRYERS WITH TAP AND FIXED-REMOVABLE HEAD FRITEUSES À HUILE ÉCONOMIQUES AVEC ROBINET ET TÊTE FIXE-AMOVIBLE



FA 8 CG

FA 8+8 CG

FA 10 MAX 230 CG



Modelo	Código	Dimensiones L x P x H (mm)	Potencia W	Voltaje V	Capacidad L	Cesta L x P x H (mm)	Grifo	Peso kg	Precio €
FA 8 CG	157506	265X420X335	4	230	8	210X235X110	SI	7	394
FA 8+8 CG	157507	530X420X335	4+4	230	8+8	210X235X110	SI	12	739
FA 10 CG	157412	265X420X335	4	230	9	210X235X110	SI	7,5	394
FA10+10 CG	157413	530X420X335	4+4	230	9+9	210X235X110	SI	13	739
FA 8 MAX 230 CG	NEW 157620	265X420X335	6	230	8	210X235X110	SI	8	793
FA 8+8 MAX 230 CG	NEW 157621	530X420X335	6+6	230	8+8	210X235X110	SI	13	1.506
FA 8 MAX 400 CG	NEW 157622	265X420X335	6	400	8	210X235X110	SI	8	847
FA 8+8 MAX 400 CG	NEW 157623	530X420X335	6+6	400	8+8	210X235X110	SI	13	1.613
FA10 MAX 230 CG	157414	265X430X335	6	230	9	210X235X110	SI	8	793
FA 10+10 MAX 230 CG	157415	530X430X335	6+6	230	9+9	210X235X110	SI	13	1.506
FA10 MAX 400 CG	NEW 157624	265X430X335	9	400	9	210X235X110	SI	8,5	927
FA 10+10 MAX 400 CG	NEW 157625	530X430X335	9+9	400	9+9	210X235X110	SI	13,5	1.760
FA 16 CG	NEW 157510	530X460X370	9	400	16	250X470X110	SI	14	950

DC



CABEZAL ELÉCTRICO EXTRAÍBLE (LIMPIEZA FÁCIL)
 REMOVABLE ELECTRIC HEAD (EASY CLEANING)
 TÊTE ÉLECTRIQUE AMOVIBLE (NETTOYAGE FACILE)

TERMOSTATO TRABAJO REGULABLE
 ADJUSTABLE WORKING THERMOSTAT
 THERMOSTAT DE TRAVAIL RÉGLABLE

TERMOSTATO SEGURIDAD
 SAFETY THERMOSTAT
 THERMOSTAT DE SÉCURITÉ

DC 8+8 CG



DOBLE CONTACTOR
 DOUBLE CONTACTOR
 DOUBLE CONTACTEUR

PATAS ANTIDESLIZANTES
 NON-SLIP LEGS
 PIEDS ANTIDÉRAPANTS

CONSTRUIDA EN ACERO INOXIDABLE AISI304
 BUILT IN AISI304 STAINLESS STEEL
 CONSTRUIT EN ACIER INOXYDABLE AISI304

GRIFO INCORPORADO PARA EVACUAR ACEITE
 BUILT-IN TAP TO DRAIN OIL
 ROBINET INTÉGRÉ POUR VIDANGER L'HUILE

ACCESORIOS NO INCLUIDOS



Ref. 907037
 CESTA REFORZADA FA 6 102,69 €

Ref. 907045
 CESTA REFORZADA FA 8/10 111,77 €

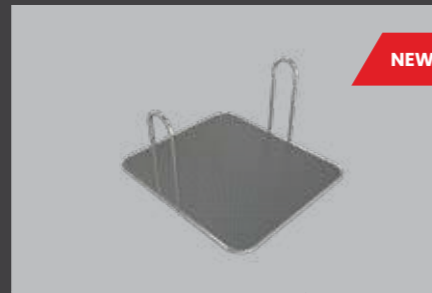

Ref. 901101
 FILTRO RESIDUOS FA 6 35,02 €

Ref. 901100
 FILTRO RESIDUOS FA 8/10 35,02 €

FREIDORAS ECONOMICAS ACEITE DOBLE CONTACTOR CON CABEZAL FIJO-EXTRAIBLE
 ECONOMIC OIL FRYERS DOUBLE CONTACTOR WITH FIXED-REMOVABLE HEAD
 FRITEUSES À HUILE ÉCONOMIQUES DOUBLE CONTACTEUR TÊTE FIXE-AMOVIBLE



DC 8+8 SG



DC 10 CG



DC 10+10 CG



Modelo	Código	Dimensiones L x P x H (mm)	Potencia W	Voltaje V	Capacidad L	Cesta L x P x H (mm)	Grifo	Peso kg	Precio €
DC 6 SG	157380	265X420X335	3	230	6	210X235X95	NO	6,5	438
DC 6+6 SG	157381	530X420X335	3+3	230	6+6	210X235X95	NO	12	847
DC 8 SG	157382	265X420X335	4	230	8	210X235X110	NO	7	480
DC 8+8 SG	157383	530X420X335	4+4	230	8+8	210X235X110	NO	12	884
DC 10 SG	157386	265X420X335	4	230	9	210X235X110	NO	7,5	480
DC 10+10 SG	157387	530X420X335	4+4	230	9+9	210X235X110	NO	13	884
DC 8 CG	157388	265X420X335	4	230	8	210X235X110	SI	7	535
DC 8+8 CG	157389	530X420X335	4+4	230	8+8	210X235X110	SI	12	995
DC 10 CG	157384	265X420X335	4	230	9	210X235X110	SI	7,5	535
DC 10+10 CG	157385	530X420X335	4+4	230	9+9	210X235X110	SI	13	995

PRO

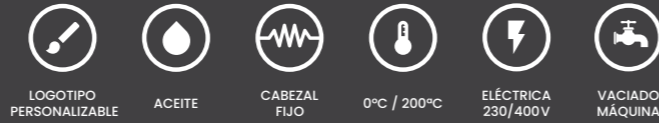

TERMOSTATO SEGURIDAD
SAFETY THERMOSTAT
THERMOSTAT DE SÉCURITÉ

CABEZAL ELÉCTRICO EXTRAÍBLE (LIMPIEZA FÁCIL)
REMOVABLE ELECTRIC HEAD (EASY CLEANING)
TÊTE ÉLECTRIQUE AMOVIBLE (NETTOYAGE FACILE)

PATAS ANTIDESLIZANTES
NON-SLIP LEGS
PIEDS ANTIDÉRAPANTS

CONSTRUIDA EN ACERO INOXIDABLE AISI304
BUILT IN AISI304 STAINLESS STEEL
CONSTRUIT EN ACIER INOXYDABLE AISI304

GRIFO INCORPORADO PARA EVACUAR ACEITE
BUILT-IN TAP TO DRAIN OIL
ROBINET INTÉGRÉ POUR VIDANGER L'HUILE

TERMOSTATO TRABAJO REGULABLE
ADJUSTABLE WORKING THERMOSTAT
THERMOSTAT DE TRAVAIL RÉGLABLE

INTERRUPTOR GENERAL
GENERAL SWITCH
INTERRUPTEUR GÉNÉRAL

CUBA V
V CUBE
CUBA V

ACCESORIOS NO INCLUIDOS



Ref. 907045
CESTA REFORZADA FA 8/10

111,77 €



Ref. 901100
FILTRO RESIDUOS FA 8/10

35,02 €

FREIDORAS ECONOMICAS ACEITE CUBA PREMIUM CON CABEZAL FIJO-EXTRAIBLE
ECONOMIC FRYERS PREMIUM TANK OIL WITH FIXED-REMOVABLE HEAD
FRITEUSES ÉCONOMIQUES HUILE À RÉSERVOIR PREMIUM TÊTE FIXE-AMOVIBLE



PRO 8 230 CG

PRO MAX 10+10 400 CG

PRO MAX 10 400 CG



Modelo	Código	Dimensiones L x P x H (mm)	Potencia W	Voltaje V	Capacidad L	Cesta L x P x H (mm)	Grifo	Peso kg	Precio €
PRO 8 230 CG	NEW 157800	265X420X335	4	230	8	210X235X110	SI	8	437
PRO 8+8 230 CG	NEW 157801	530X420X335	4+4	230	8+8	210X235X110	SI	13	795
PRO 10 230 CG	NEW 157802	265X420X335	4	230	9	210X235X110	SI	8	437
PRO 10+10 CG	NEW 157803	530X420X335	4+4	230	9+9	210X235X110	SI	13	795
PRO DC 8 230 CG	NEW 157804	265X420X335	4	230	8	210X235X110	SI	8	578
PRO DC 8+8 230 CG	NEW 157805	530X420X335	4+4	230	8+8	210X235X110	SI	13	1.081
PRO DC10 230 CG	NEW 157806	265X420X335	4	230	9	210X235X110	SI	8	578
PRO DC10+10 230 CG	NEW 157807	530X420X335	4+4	230	9+9	210X235X110	SI	13	1.081
PRO MAX 8 230 CG	NEW 157808	265X420X335	6	230	8	210X235X110	SI	8	836
PRO MAX 8+8 230 CG	NEW 157809	530X420X335	6+6	230	8+8	210X235X110	SI	13	1.592
PRO MAX 8 400 CG	NEW 157810	265X420X335	6	400	8	210X235X110	SI	8	890
PRO MAX 8+8 400 CG	NEW 157811	530X420X335	6+6	400	8+8	210X235X110	SI	13	1.699
PRO MAX 10 230 CG	NEW 157812	265X420X335	6	230	9	210X235X110	SI	8	836
PRO MAX 10+10 230 CG	NEW 157813	530X420X335	6+6	230	9+9	210X235X110	SI	13	1.592
PRO MAX 10 400 CG	NEW 157814	265X420X335	9	400	9	210X235X110	SI	8,5	970
PRO MAX 10+10 400 CG	NEW 157815	530X420X335	9+9	400	9+9	210X235X110	SI	13,5	1.846



CONSTRUIDA EN ACERO INOXIDABLE AISI304
BUILT IN AISI304 STAINLESS STEEL
CONSTRUIT EN ACIER INOXYDABLE AISI304

CABEZAL ELÉCTRICO EXTRAÍBLE (LIMPIEZA FÁCIL)
REMOVABLE ELECTRIC HEAD (EASY CLEANING)
TÊTE ÉLECTRIQUE AMOVIBLE (NETTOYAGE FACILE)

TERMOSTATO TRABAJO REGULABLE
ADJUSTABLE WORKING THERMOSTAT
THERMOSTAT DE TRAVAIL RÉGLABLE

TERMOSTATO SEGURIDAD
SAFETY THERMOSTAT
THERMOSTAT DE SÉCURITÉ

INTERRUPTOR GENERAL
GENERAL SWITCH
INTERRUPTEUR GÉNÉRAL

FAP 25+25



PATAS ANTIDESLIZANTES
NON-SLIP LEGS
PIEDS ANTIDÉRAPANTS

GRIFO INCORPORADO PARA EVACUAR ACEITE
BUILT-IN TAP TO DRAIN OIL
ROBINET INTÉGRÉ POUR VIDANGER L'HUILE

ACCESORIOS NO INCLUIDOS

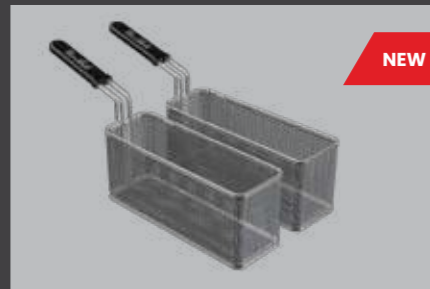

Ref. 907052
CESTA PARTIDA 12/2 - 17/2 141,53 €/ud

Ref. 907033
CESTA PARTIDA 25/2 146,20 €/ud

Ref. 907052
CESTA PARTIDA 35/2 254,76 €/ud



Ref. 901102
FILTRO RESIDUOS MOD.10 40,10 €

Ref. 901103
FILTRO RESIDUOS MOD.12/17 45,28 €

Ref. 901104
FILTRO RESIDUOS MOD.25 50,30 €

Ref. 901105
FILTRO RESIDUOS MOD.35 55,63 €

FREIDORAS ACEITE CABEZAL FIJO – EXTRAÍBLE OIL FRYERS FIXED HEAD – REMOVABLE FRITEUSES À HUILE TÊTE FIXE – AMOVIBLE



FAP 12+12 400

FAP 17 400

FAP 10



Modelo	Código	Dimensiones L x P x H (mm)	Potencia W	Voltaje V	Capacidad L	Cesta L x P x H (mm)	Elevación Cabezal	Peso kg	Precio €
FAP 10	157407	325x510x450	4	230	10	185x245x110	NO	14	834
FAP 10+10	157409	650x510x450	4+4	230	10+10	185x245x110	NO	27	1.604
FAP 10 MAX 230	157424	325x600x450	6	230	10	185x245x110	NO	18	1.362
FAP 10+10 MAX 230	157425	650x600x450	6+6	230	10+10	185x245x110	NO	34	2.660
FAP 10 MAX 400	157426	325x600x450	6	400	10	185x245x110	NO	18	1.416
FAP 10+10 400 MAX	157427	650x600x450	6+6	400	10+10	185x245x110	NO	34	2.767
FAP 12 230	157430	360x645x450	6	230	12	205x285x120	NO	27	1.536
FAP 12+12 230	157431	720x645x450	6+6	230	12+12	205x285x120	NO	51	3.009
FAP 12 400	157432	360x645x450	7	400	12	205x285x120	NO	27	1.556
FAP 12+12 400	157433	720x645x450	7+7	400	12+12	205x285x120	NO	51	3.040
FAP 17 230	157418	360x645x940	6	230	17	205x285x120	NO	18	1.777
FAP 17+17 230	157419	720x645x940	6+6	230	17+17	205x285x120	NO	51	3.366
FAP 17 400	157420	360x645x940	7	400	17	205x285x120	NO	28	1.832
FAP 17+17 400	157423	720x645x940	7+7	400	17+17	205x285x120	NO	51	3.482
FAP 25 400	157434	410x645x940	15	400	25	235x325x140	NO	38	2.388
FAP 25+25 400	157435	820x645x940	15+15	400	25+25	235x325x140	NO	71	4.624
FAP 35 400	NEW 157436	530x645x940	25	400	35	350x325x150	NO	44	3.138
FAP 35+35 400	NEW 157437	1065x645x940	25+25	400	35+35	350x325x150	NO	86	5.727

FAH



CABEZAL ELÉCTRICO EXTRAÍBLE (LIMPIEZA FÁCIL)
 REMOVABLE ELECTRIC HEAD (EASY CLEANING)
 TÊTE ÉLECTRIQUE AMOVIBLE (NETTOYAGE FACILE)

TERMOSTATO TRABAJO REGULABLE
 ADJUSTABLE WORKING THERMOSTAT
 THERMOSTAT DE TRAVAIL RÉGLABLE

INTERRUPTOR GENERAL
 GENERAL SWITCH
 INTERRUPTEUR GÉNÉRAL

TERMOSTATO SEGURIDAD
 SAFETY THERMOSTAT
 THERMOSTAT DE SÉCURITÉ

SISTEMA DE ELEVACIÓN
 ELEVATION SYSTEM
 SYSTÈME D'ÉLÉVATION

PATAS ANTIDESLIZANTES
 NON-SLIP LEGS
 PIEDS ANTIDÉRAPANTS

CONSTRUIDA EN ACERO INOXIDABLE AISI304
 BUILT IN AISI304 STAINLESS STEEL
 CONSTRUIT EN ACIER INOXYDABLE AISI304

GRIFO INCORPORADO PARA EVACUAR ACEITE
 BUILT-IN TAP TO DRAIN OIL
 ROBINET INTÉGRÉ POUR VIDANGER L'HUILE

ACCESORIOS NO INCLUIDOS

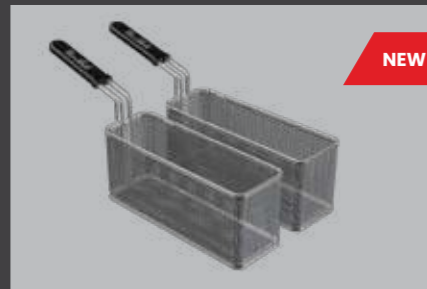

Ref. 907052
 CESTA PARTIDA 12/2 - 17/2 141,53 €/ud

Ref. 907033
 CESTA PARTIDA 25/2 146,20 €/ud

Ref. 907052
 CESTA PARTIDA 35/2 254,76 €/ud



Ref. 901102
 FILTRO RESIDUOS MOD.10 40,10 €

Ref. 901103
 FILTRO RESIDUOS MOD.12/17 45,28 €

Ref. 901104
 FILTRO RESIDUOS MOD.25 50,30 €

Ref. 901105
 FILTRO RESIDUOS MOD.35 55,63 €

FREIDORAS ACEITE CABEZAL MOVIL - EXTRAIBLE MOBILE HEAD OIL FRYERS - REMOVABLE FRITEUSES À HUILE À TÊTE MOBILE - AMOVIBLES



Modelo	Código	Dimensiones L x P x H (mm)	Potencia W	Voltaje V	Capacidad L	Cesta L x P x H (mm)	Elevación Cabezal	Peso kg	Precio €
FAH 10 230	157356	325X600X450	6	230	10	185X245X110	SI	17	1.410
FAH 10+10 230	157358	650X600X450	6+6	230	10+10	185X245X110	SI	33	2.786
FAH 10 400	157357	325X600X450	6	400	10	185X245X110	SI	17	1.466
FAH 10+10 400	157359	650X600X450	6+6	400	10+10	185X245X110	SI	33	2.899
FAH 12 230	157340	360X645X450	6	230	12	205X285X120	SI	27	1.599
FAH 12+12 230	157341	720X645X450	6+6	230	12+12	205X285X120	SI	51	3.166
FAH 12 400	157342	360X645X450	7	400	12	205X285X120	SI	27	1.655
FAH 12+12 400	157343	720X645X450	7+7	400	12+12	205X285X120	SI	51	3.297
FAH 17 230	157360	360X645X940	6	230	17	205X285X120	SI	27	1.840
FAH 17+17 230	157362	780X645X940	6+6	230	17+17	205X285X120	SI	51	3.557
FAH 17 400	157361	360X645X940	7	400	17	205X285X120	SI	27	1.895
FAH 17+17 400	157363	780X645X940	7+7	400	17+17	205X285X120	SI	51	3.672
FAH 25 400	157365	410X645X940	15	400	25	235X325X140	SI	37	2.462
FAH 25+25 400	157367	820X645X940	15+15	400	25+25	235X325X140	SI	69	4.795
FAH 35 400	NEW 157368	530X645X940	25	400	35	350X325X150	SI	41	3.217
FAH 35+35 400	NEW 157370	1065X645X940	25+25	400	35+35	350X325X150	SI	86	5.946



TERMOSTATO TRABAJO REGULABLE
ADJUSTABLE WORKING THERMOSTAT
THERMOSTAT DE TRAVAIL RÉGLABLE

TERMOSTATO SEGURIDAD
SAFETY THERMOSTAT
THERMOSTAT DE SÉCURITÉ

CABEZAL ELÉCTRICO EXTRAÍBLE (LIMPIEZA FÁCIL)
REMOBABLE ELECTRIC HEAD (EASY CLEANING)
TÊTE ÉLECTRIQUE AMOVIBLE (NETTOYAGE FACILE)

SISTEMA DE ELEVACIÓN
ELEVATION SYSTEM
SYSTÈME D'ÉLEVATION

INTERRUPTOR GENERAL
GENERAL SWITCH
INTERRUPTEUR GÉNÉRAL

GRIFO INCORPORADO PARA EVACUAR ACEITE
BUILT-IN TAP TO DRAIN OIL
ROBINET INTÉGRÉ POUR VIDANGER L'HUILE

PATAS ANTIDESLIZANTES
NON-SLIP LEGS
PIEDS ANTIDÉRAPANTS

CONSTRUIDA EN ACERO INOXIDABLE AISI304
BUILT IN AISI304 STAINLESS STEEL
CONSTRUIT EN ACIER INOXYDABLE AISI304

ACCESORIOS NO INCLUIDOS

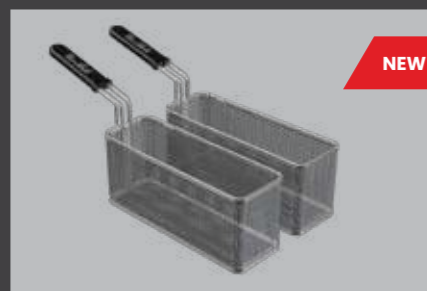

Ref. 907052
CESTA PARTIDA 12/2 - 17/2 141,53 €/ud

Ref. 907033
CESTA PARTIDA 25/2 146,20 €/ud



Ref. 901102
FILTRO RESIDUOS MOD.10 40,10 €

Ref. 901103
FILTRO RESIDUOS MOD.12/17 45,28 €

Ref. 901104
FILTRO RESIDUOS MOD.25 50,30 €

FREIDORAS ACEITE CABEZAL EXTRAÍBLE DE ALTO RENDIMIENTO HIGH POWER OIL FRYERS WITH HEAD REMOVABLE FRITEUSES À HUILE HAUTE PUISSANCE À TÊTE AMOVIBLE



Modelo	Código	Dimensiones L x P x H (mm)	Potencia W	Voltaje V	Capacidad L	Cesta L x P x H (mm)	Elevación Cabezal	Peso kg	Precio €
FARP 10 400	157326	325X600X450	10	400	10	185X245X110	NO	17	1.904
FARP 10+10 400	157327	650x600x450	10+10	400	10+10	185X245X110	NO	33	3.563
FARP 12 400	157332	360X645X450	17	400	12	205X285X120	NO	20	1.982
FARP 12+12 400	157333	720X645X450	17+17	400	12+12	205X285X120	NO	37	3.807
FARP 17 400	157328	360X645X940	17	400	17	205X285X120	NO	27	2.424
FARP 17+17 400	157329	780x645x940	17+17	400	17+17	205X285X120	NO	51	4.534
FARP 25 400	157330	410X645X940	25	400	25	235X325X140	NO	37	3.240
FARP 25+25 400	157331	820x645x940	25+25	400	25+25	235X325X140	NO	69	6.261
FAR 10 400	157320	325X600X450	10	400	10	185X245X110	SI	17	1.970
FAR 10+10 400	157319	650x600x450	10+10	400	10+10	185X245X110	SI	33	3.686
FAR 12 400	157317	360X645X450	17	400	12	205X285X120	SI	20	2.119
FAR 12+12 400	157318	720X645X450	17+17	400	12+12	205X285X120	SI	37	4.050
FAR 17 400	157321	360X645X940	17	400	17	205X285X120	SI	27	2.507
FAR 17+17 400	157322	780x645x940	17+17	400	17+17	205X285X120	SI	51	4.690
FAR 25 400	157324	410X645X940	25	400	25	235X325X140	SI	37	3.353
FAR 25+25 400	157325	820x645x940	25+25	400	25+25	235X325X140	SI	69	6.478

TRIPLE FAP/FAH



CABEZAL ELÉCTRICO EXTRAÍBLE (LIMPIEZA FÁCIL)
REMOBABLE ELECTRIC HEAD (EASY CLEANING)
TÊTE ÉLECTRIQUE AMOVIBLE (NETTOYAGE FACILE)

TERMOSTATO TRABAJO REGULABLE
ADJUSTABLE WORKING THERMOSTAT
THERMOSTAT DE TRAVAIL RÉGLABLE

FAH 17+17+17 400

INTERRUPTOR GENERAL
GENERAL SWITCH
INTERRUPTEUR GÉNÉRAL

TERMOSTATO SEGURIDAD
SAFETY THERMOSTAT
THERMOSTAT DE SÉCURITÉ

PATAS ANTIDESLIZANTES
NON-SLIP LEGS
PIEDS ANTIDÉRAPANTS

GRIFO INCORPORADO PARA EVACUAR ACEITE
BUILT-IN TAP TO DRAIN OIL
ROBINET INTÉGRÉ POUR VIDANGER L'HUILE

CONSTRUIDA EN ACERO INOXIDABLE AISI304
BUILT IN AISI304 STAINLESS STEEL
CONSTRUIT EN ACIER INOXYDABLE AISI304

ACCESORIOS NO INCLUIDOS

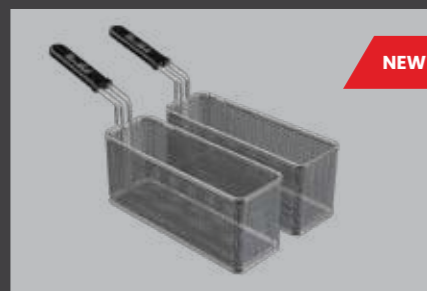

Ref. 907052
CESTA PARTIDA 12/2 - 17/2 141,53 €/ud



Ref. 901102
FILTRO RESIDUOS MOD.10 40,10 €
Ref. 901103
FILTRO RESIDUOS MOD.12/17 45,28 €

FREIDORAS ACEITE CABEZAL EXTRAIBLE
OIL FRYERS WITH REMOVABLE HEAD
FRITEUSES À HUILE À TÊTE AMOVIBLE



FAH 12+12+12 400

FAP 10+10+10



Modelo	Código	Dimensiones L x P x H (mm)	Potencia W	Voltaje V	Capacidad L	Cesta L x P x H (mm)	Elevación Cabezal	Peso kg	Precio €
FAP 10+10+10 230	156200	975x510x475	4+4+4	230	10+10+10	185X245X110	NO	42	2.165
FAP 10+10+10 MAX 230	156220	975x600x450	6+6+6	230	10+10+10	185X245X110	NO	54	3.686
FAP 10+10+10 MAX 400	156221	975x600x450	6+6+6	400	10+10+10	185X245X110	NO	54	3.841
FAP 12+12+12 230	156340	1080x580x450	6+6+6	230	12+12+12	205X285X120	NO	81	4.189
FAP 12+12+12 400	156341	1080x580x450	7+7+7	400	12+12+12	205X285X120	NO	81	4.240
FAP 17+17+17 230	156450	1080x645x940	6+6+6	230	17+17+17	205X285X120	NO	153	4.766
FAP 17+17+17 400	156451	1080x645x940	7+7+7	400	17+17+17	205X285X120	NO	153	4.935
FAH 10+10+10 230	156250	975x510x475	6+6+6	230	10+10+10	185X245X110	SI	42	3.854
FAH 10+10+10 400	156251	975x600x450	6+6+6	400	10+10+10	185X245X110	SI	54	4.017
FAH 12+12+12 230	156330	1080x580x450	6+6+6	230	12+12+12	205X285X120	SI	81	4.402
FAH 12+12+12 400	156331	1080x580x450	7+7+7	400	12+12+12	205X285X120	SI	81	4.590
FAH 17+17+17 230	156430	1080x645x940	6+6+6	230	17+17+17	205X285X120	SI	153	5.072
FAH 17+17+17 400	156431	1080x645x940	7+7+7	400	17+17+17	205X285X120	SI	153	5.239

FP/F



CABEZAL ELÉCTRICO EXTRAÍBLE (LIMPIEZA FÁCIL)
 REMOVABLE ELECTRIC HEAD (EASY CLEANING)
 TÊTE ÉLECTRIQUE AMOVIBLE (NETTOYAGE FACILE)

TERMOSTATO TRABAJO REGULABLE
 ADJUSTABLE WORKING THERMOSTAT
 THERMOSTAT DE TRAVAIL RÉGLABLE

F10+10

TERMOSTATO SEGURIDAD
 SAFETY THERMOSTAT
 THERMOSTAT DE SÉCURITÉ

PATAS ANTIDESLIZANTES
 NON-SLIP LEGS
 PIEDS ANTIDÉRAPANTS

SISTEMA DE ELEVACIÓN
 ELEVATION SYSTEM
 SYSTÈME D'ÉLÉVATION

CONSTRUIDA EN ACERO INOXIDABLE AISI304
 BUILT IN AISI304 STAINLESS STEEL
 CONSTRUIT EN ACIER INOXYDABLE AISI304

GRIFO INCORPORADO PARA EVACUAR ACEITE
 BUILT-IN TAP TO DRAIN OIL
 ROBINET INTÉGRÉ POUR VIDANGER L'HUILE

ACCESORIOS NO INCLUIDOS



Ref. 901102
FILTRO RESIDUOS MOD.10 40,10 €

FREIDORAS ECONOMICAS AGUA-ACEITE CABEZAL EXTRAIBLE

ECONOMIC WATER-OIL FRYERS WITH REMOVABLE HEAD
 FRITEUSES EAU-HUILE ÉCONOMIQUES À TÊTE AMOVIBLE

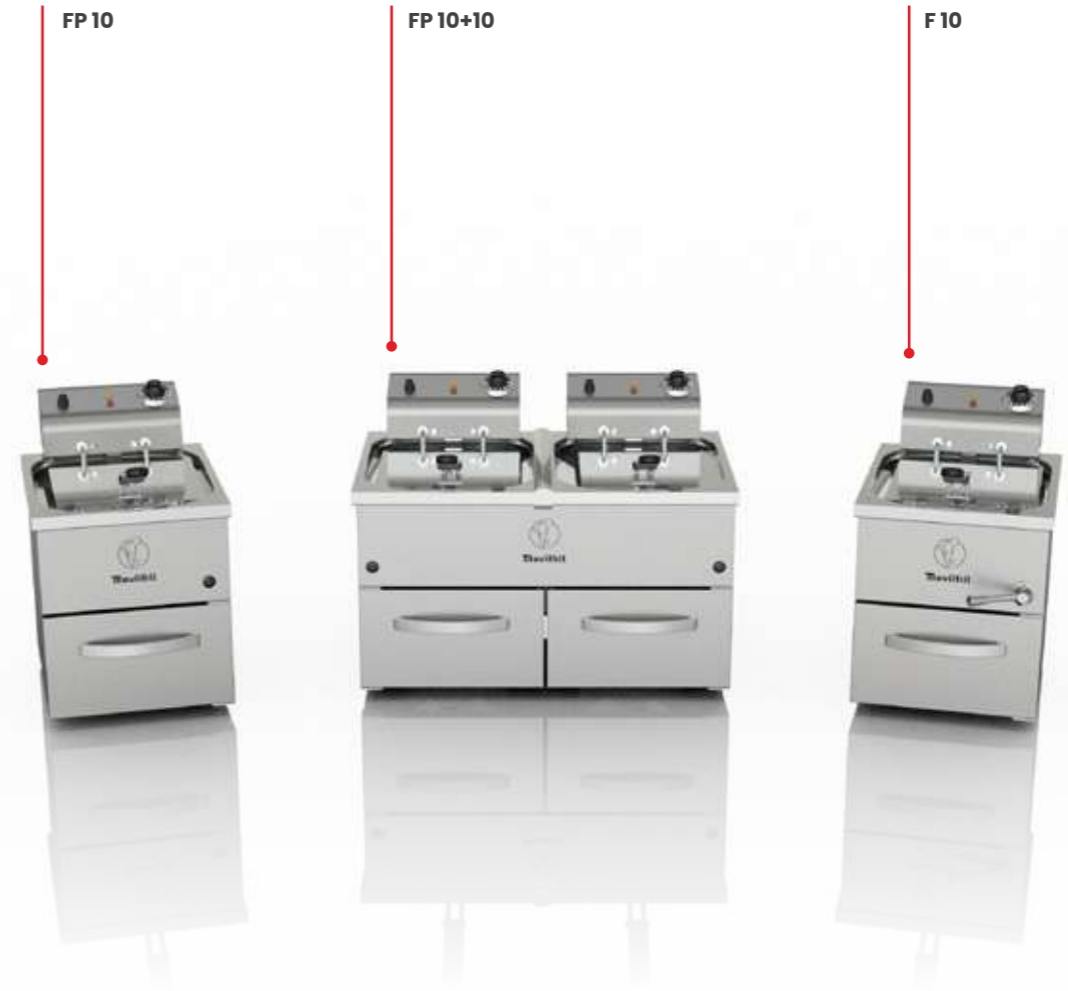

Modelo	Código	Dimensiones L x P x H (mm)	Potencia W	Voltaje V	Capacidad			Cesta L x P x H (mm)	Elevación Cabezal	Peso kg	Precio €
					Agua (L)	Aceite (L)	Total (L)				
FP 10 230	107070	325X510X475	4	230	3,5	10	13,5	185X245X110	NO	14	957
FP 10+10 230	107071	650X510X475	4+4	230	3,5+3,5	10+10	13,5+13,5	185X245X110	NO	27	1.840
F 10 230	107066	325X510X475	4	230	3,5	10	13,5	185X245X110	SI	14	1.003
F 10+10 230	107067	650X510X475	4+4	230	3,5+3,5	10+10	13,5+13,5	185X245X110	SI	27	1.982



CABEZAL ELÉCTRICO EXTRAÍBLE (LIMPIEZA FÁCIL)
 REMOVABLE ELECTRIC HEAD (EASY CLEANING)
 TÊTE ÉLECTRIQUE AMOVIBLE (NETTOYAGE FACILE)

TERMOSTATO TRABAJO REGULABLE
 ADJUSTABLE WORKING THERMOSTAT
 THERMOSTAT DE TRAVAIL RÉGLABLE

INTERRUPTOR GENERAL
 GENERAL SWITCH
 INTERRUPTEUR GÉNÉRAL

TERMOSTATO SEGURIDAD
 SAFETY THERMOSTAT
 THERMOSTAT DE SÉCURITÉ

SISTEMA DE ELEVACIÓN
 ELEVATION SYSTEM
 SYSTÈME D'ÉLÉVATION

PATAS ANTIDESLIZANTES
 NON-SLIP LEGS
 PIEDS ANTIDÉRAPANTS

CONSTRUIDA EN ACERO INOXIDABLE AISI304
 BUILT IN AISI304 STAINLESS STEEL
 CONSTRUIT EN ACIER INOXYDABLE AISI304

GRIFO INCORPORADO PARA EVACUAR ACEITE
 BUILT-IN TAP TO DRAIN OIL
 ROBINET INTÉGRÉ POUR VIDANGER L'HUILE

ACCESORIOS NO INCLUIDOS

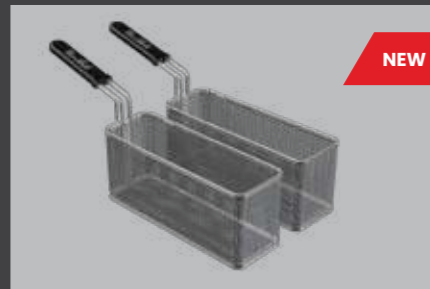

Ref. 907052
 CESTA PARTIDA 12/2 - 17/2 141,53 €/ud

Ref. 907033
 CESTA PARTIDA 25/2 146,20 €/ud

Ref. 907052
 CESTA PARTIDA 35/2 254,76 €/ud



Ref. 901102
 FILTRO RESIDUOS MOD.10 40,10 €

Ref. 901103
 FILTRO RESIDUOS MOD.12/17 45,28 €

Ref. 901104
 FILTRO RESIDUOS MOD.25 50,30 €

Ref. 901105
 FILTRO RESIDUOS MOD.35 55,63 €

FREIDORAS AGUA-ACEITE CABEZAL MOVIL - EXTRAIBLE

WATER-OIL FRYERS MOBILE HEAD - REMOVABLE
 FRITEUSES EAU-HUILE TÊTE MOBILE - AMOVIBLE



Modelo	Código	Dimensiones L x P x H (mm)	Potencia W	Voltaje V	Capacidad			Cesta L x P x H (mm)	Elevación Cabezal	Peso kg	Precio €
					Agua (L)	Aceite (L)	Total (L)				
FH 10 230	107306	325X600X450	6	230	3,5	10	13,5	185x245x110	SI	18	1.453
FH 10+10 230	107308	650X600X450	6+6	230	3,5+3,5	10+10	13,5+13,5	185x245x110	SI	34	2.843
FH 10 400	107307	325X600X450	6	400	3,5	10	13,5	185x245x110	SI	18	1.514
FH 10+10 400	107309	650X600X450	6+6	400	3,5+3,5	10+10	13,5+13,5	185x245x110	SI	34	2.964
FH 17 230	107310	360X645X940	6	230	4,5	15	19,5	205x285x120	SI	28	1.866
FH 17+17 230	107312	720X645X940	6+6	230	4,5+4,5	15+15	19,5+19,5	205x285x120	SI	51	3.552
FH 17 400	107311	360X645X940	7	400	4,5	15	19,5	205x285x120	SI	28	1.939
FH 17+17 400	107313	720X645X940	7+7	400	4,5+4,5	15+15	19,5+19,5	205x285x120	SI	51	3.680
FH 25 400	107315	410X645X940	15	400	8	23	31	235x325x140	SI	38	2.677
FH 25+25 400	107317	820X645X940	15+15	400	8+8	23+23	31+31	235x325x140	SI	71	5.056
FH35 400	NEW 107318	530X645X940	25	400	14	30	44	350x325x150	SI	44	3.262
FH35+35 400	NEW 107320	1065X645X940	25+25	400	14+14	30+30	44+44	350x325x150	SI	86	6.037

TRIPLE FP/F/FH



CABEZAL ELÉCTRICO EXTRAÍBLE (LIMPIEZA FÁCIL)
 REMOVABLE ELECTRIC HEAD (EASY CLEANING)
 TÊTE ÉLECTRIQUE AMOVIBLE (NETTOYAGE FACILE)

TERMOSTATO TRABAJO REGULABLE
 ADJUSTABLE WORKING THERMOSTAT
 THERMOSTAT DE TRAVAIL RÉGLABLE

FH 10+10+10 400

TERMOSTATO SEGURIDAD
 SAFETY THERMOSTAT
 THERMOSTAT DE SÉCURITÉ

INTERRUPTOR GENERAL
 GENERAL SWITCH
 INTERRUPTEUR GÉNÉRAL

PATAS ANTIDESLIZANTES
 NON-SLIP LEGS
 PIEDS ANTIDÉRAPANTS

CONSTRUIDA EN ACERO INOXIDABLE AISI304
 BUILT IN AISI304 STAINLESS STEEL
 CONSTRUIT EN ACIER INOXYDABLE AISI304

GRIFO INCORPORADO PARA EVACUAR ACEITE
 BUILT-IN TAP TO DRAIN OIL
 ROBINET INTÉGRÉ POUR VIDANGER L'HUILE

ACCESORIOS NO INCLUIDOS

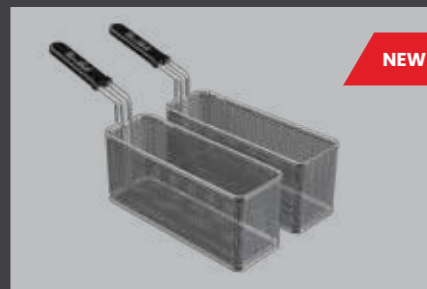

Ref. 907052
CESTA PARTIDA 12/2 - 17/2 141,53 €/ud



Ref. 901102
FILTRO RESIDUOS MOD.10 40,10 €
 Ref. 901103
FILTRO RESIDUOS MOD.12/17 45,28 €

FREIDORAS AGUA-ACEITE CABEZAL EXTRAIBLE WATER-OIL FRYERS WITH REMOVABLE HEAD FRITEUSES EAU-HUILE À TÊTE AMOVIBLE



FH 17+17+17 230



FP 10+10+10

Modelo	Código	Dimensiones L x P x H (mm)	Potencia W	Voltaje V	Capacidad			Cesta L x P x H (mm)	Elevación Cabezal	Peso kg	Precio €
					Agua (L)	Aceite (L)	Total (L)				
FP 10+10+10 230	108080	975x510x475	4+4+4	230	3,5+3,5+3,5	10+10+10	13,5+13,5+13,5	185X245X110	NO	40	2.585
F 10+10+10 230	108100	975x510x475	4+4+4	230	3,5+3,5+3,5	10+10+10	13,5+13,5+13,5	185X245X110	SI	40	2.729
FH 10+10+10 230	108200	975x600x450	6+6+6	230	3,5+3,5+3,5	10+10+10	13,5+13,5+13,5	185X245X110	SI	54	3.989
FH 10+10+10 400	108201	975x600x450	6+6+6	400	3,5+3,5+3,5	10+10+10	13,5+13,5+13,5	185X245X110	SI	54	4.167
FH 17+17+17 230	108400	1080x645x940	6+6+6	230	4,5+4,5+4,5	15+15+15	19,5+19,5+19,5	208X285X120	SI	80	5.087
FH 17+17+17 400	108401	1080x645x940	7+7+7	400	4,5+4,5+4,5	15+15+15	19,5+19,5+19,5	208X285X120	SI	80	5.262



CUBETA EMBUTIDA SIN SOLDADURAS
EMBEDDED BOWL WITHOUT WELDING
BOL ENCASTRABLE SANS SOUDURE

TERMOSTATO TRABAJO REGULABLE
ADJUSTABLE WORKING THERMOSTAT
THERMOSTAT DE TRAVAIL RÉGLABLE

FGS-10+10 MAX

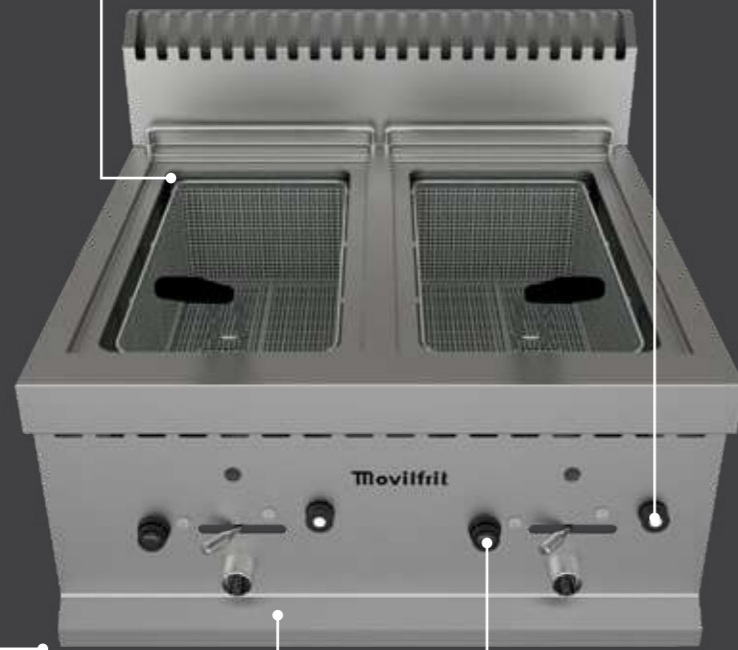

PATAS ANTIDESLIZANTES
NON-SLIP LEGS
PIEDS ANTIDÉRAPANTS

CONSTRUIDA EN ACERO INOXIDABLE AISI304
BUILT IN AISI304 STAINLESS STEEL
CONSTRUIT EN ACIER INOXYDABLE AISI304

PIEZO ELÉCTRICO
PIEZO ELECTRIC
PIEZO ÉLECTRIQUE

FREIDORA GAS SOBREMOSTRADOR QUEMADORES EXTERNOS COUNTERTOP GAS FRYERS WITH EXTERNAL BURNERS FRITEUSES À GAZ DE COMPTOIR À BRÛLEURS EXTERNES



FGS 10 MAX



FGS 8+8



FGS 8



Modelo	Código	Dimensiones L x P x H (mm)	Potencia Kw Kcal/h	Capacidad L	Tensión V	Cesta L x P x H (mm)	Peso kg	Precio €
FGS 8	500010	330x540x370	7 11762	8	--	240x240x120	10	819
FGS 8+8	500011	660x540x370	14 11762+11762	8+8	--	240x240x120	19	1.238
FGS 10 MAX	NEW 500016	350x615x285	6,6 11090	8	--	228x280x100	28	2.001
FGS 10+10 MAX	NEW 500017	700x615x285	13,2 11090/11090	8+8	--	228x280x100	45	3.486



CUBETA EMBUTIDA SIN SOLDADURAS
 EMBEDDED BOWL WITHOUT WELDING
 BOL ENCASTRABLE SANS SOUDURE



FGM 21+21 MAX

TODAS LAS FREIDORAS DOBLES CONTIENEN CESTAS PARTIDAS EN UNA DE SUS CUBAS
 ALL DOUBLE FRYERS CONTAIN DOUBLE BASKETS IN ONE OF THE TANKS
 TOUTES LES FRITEUSES DOUBLES CONTIENNENT DES PANIERS DOUBLES DANS L'UN DES RÉSERVOIRS

TERMOSTATO TRABAJO REGULABLE
 ADJUSTABLE WORKING THERMOSTAT
 THERMOSTAT DE TRAVAIL RÉGLABLE

RECIPIENTE FILTRADO ACEITE
 OIL FILTER CONTAINER
 FILTRE À HUILE CONTENANT

PATAS ANTIDESLIZANTES
 NON-SLIP LEGS
 PIEDS ANTIDÉRAPANTS

CONSTRUIDA EN ACERO INOXIDABLE AISI304
 BUILT IN AISI304 STAINLESS STEEL
 CONSTRUIT EN ACIER INOXYDABLE AISI304

GRIFO INCORPORADO PARA EVACUAR ACEITE
 BUILT-IN TAP TO DRAIN OIL
 ROBINET INTÉGRÉ POUR VIDANGER L'HUILE

FGM 13 MAX



FGM 17+17 MAX



FGM 21 MAX



Modelo	Código	Dimensiones L x P x H (mm)	Potencia		Capacidad L	Tensión V	Cesta L x P x H (mm)	Peso kg	Precio €
			Kw	Kcal/h					
FGM 13 MAX	NEW 500012	400x730x900	12	20160	13	230	215x310x120	57	3.441
FGM 13+13 MAX	NEW 500013	800x730x900	12+12	20160+20160	13+13	230	215x310x120	92	6.429
FGM 17 MAX	NEW 500014	400x730x900	16	26880	17	230	300x310x120	60	3.762
FGM 17+17 MAX	NEW 500015	800x730x900	16+16	26880+26880	17+17	230	300x310x120	95	6.919
FGM 21 MAX	NEW 500018	400x900x900	19	31920	21	230	300x400x120	80	4.324
FGM 21+21 MAX	NEW 500019	800x900x900	19+19	31920+31920	21+21	230	300x400x120	115	7.578



VITRINAS

DISPLAY CASES · VITRINES

CRISTAL CURVO ABATIBLE
FOLDING CURVED GLASS
VITRE ABATTABLE COURBÉ

CRISTAL PLANO
STRAIGHT GLASS
VITRE PLAT

EXPOSITORES
NEUTRAL DISPLAY CASES
VITRINE NEUTRE

ENCIMERAS
COUNTERTOP
BASE FROIDE

IRON

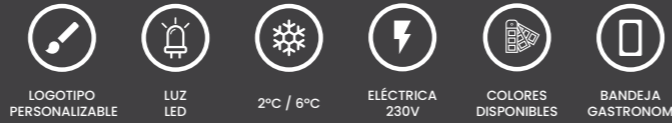

CRISTAL ABATIBLE (FÁCIL LIMPIEZA)
FOLDING GLASS (EASY CLEANING)
VITRE ABATTABLE (FACIL NETTOYAGE)

BANDEJAS INCLUIDAS
TRAYS INCLUDED
PLATEAUX INCLUS

21 CM PARA APOYAR PLATOS
21 CM TO SUPPORT PLATES
21 CM POUR SUPPORT PLANCHAS

LED ALTA CALIDAD
HIGH QUALITY LED
LED DE HAUTE QUALITÉ

CUBA SIN ÁNGULOS
CUBA WITHOUT ANGLES
CUBA SANS ANGLES



IRON 6

INTERRUPTOR LED
LED SWITCH
INTERRUPTEUR LED

TERMOSTATO DIGITAL REGULABLE
ADJUSTABLE DIGITAL THERMOSTAT
THERMOSTAT DIGITAL RÉGLABLE

PUERTAS CORREDERAS
SLIDING DOORS
PORTES COULISSANTES

INTERRUPTOR GENERAL
GENERAL SWITCH
INTERRUPTEUR GÉNÉRAL

COMPRESOR HERMÉTICO CON CONDENSADOR VENTILADO
HERMETIC COMPRESSOR WITH VENTILATED CONDENSER
COMPRESSEUR HERMÉTIQUE AVEC CONDENSEUR VENTILÉ

ACCESORIOS NO INCLUIDOS



Ref. 916872
JUEGO SOPORTES 111,21 €



Ref. 905415
KIT DESAGÜE 65,00 €



Ref. 918361
PARRILLAS CUBA PLANA 36,00 €/ud



PARA MOTOR LADO CONTRARIO:
FAMILIA CORAL (PÁGINAS 50-51)

VITRINA REFRIGERADA CON CRISTAL CURVO ABATIBLE

REFRIGERATED DISPLAY CASES WITH CURVE CRYSTAL FOLDABLE
VITRINES RÉFRIGÉRÉES À VITRES COURBÉES PLIANTES

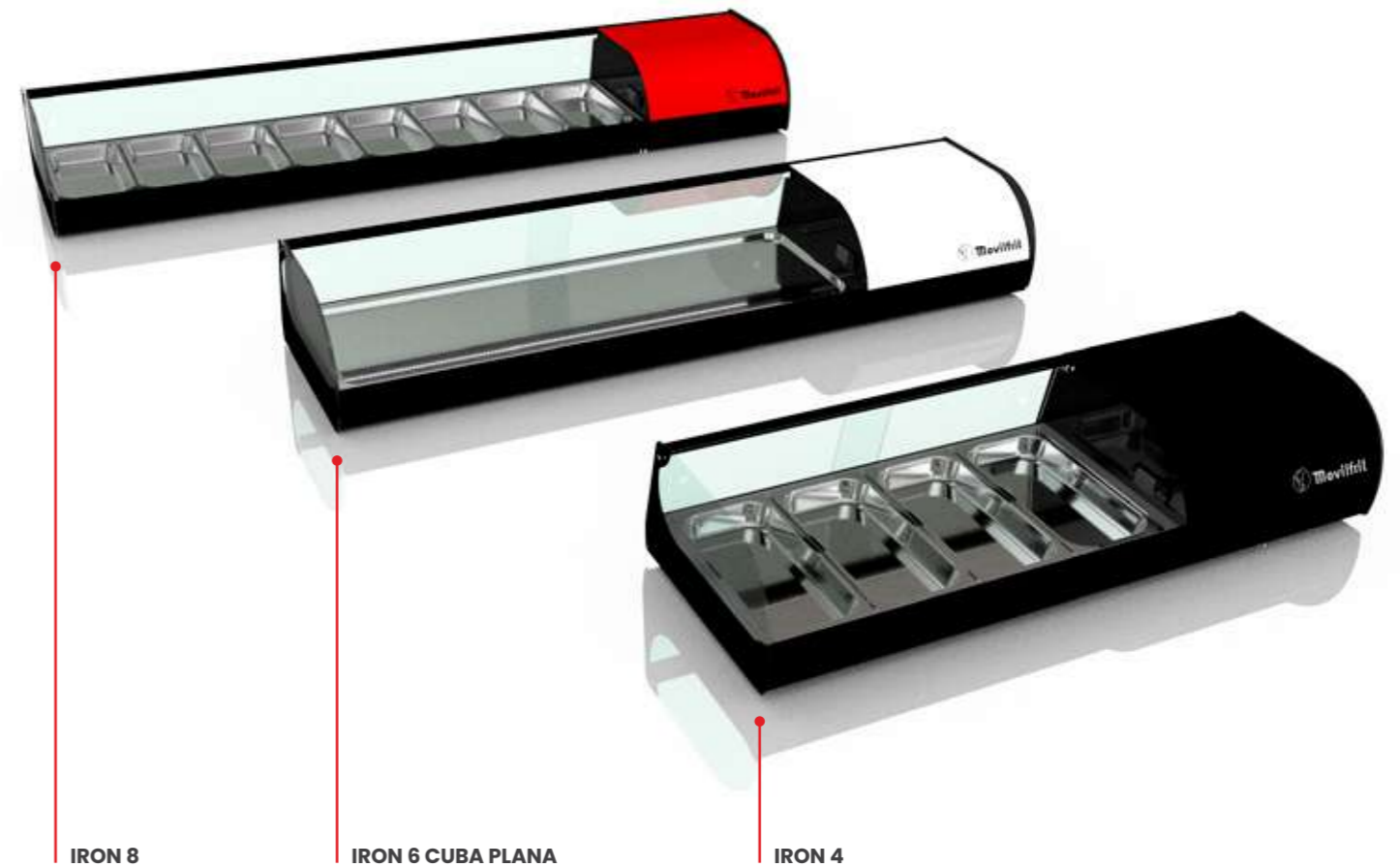

IRON 8

IRON 6 CUBA PLANA

IRON 4

Modelo	Código			Dimensiones L x P x H (mm)	Potencia W	Temperatura °C	Tensión V	Capacidad	Peso kg	Precio €
	●	○	●							
IRON 4	877015	877024	877021	1146X390X215	160	+2 / +6	230	4XGNI/3x40	24	1.067
IRON 6	877016	877025	877022	1487X390X215	160	+2 / +6	230	6XGNI/3x40	34	1.164
IRON 8	877017	877026	877023	1826X390X215	160	+2 / +6	230	8XGNI/3x40	40	1.279
IRON 6 REMOTA	876909	--	--	1146X390X215	160	+2 / +6	230	6XGNI/3x40	32	1.327
IRON 8 REMOTA	876910	--	--	1487X390X215	160	+2 / +6	230	8XGNI/3x40	35	1.459
IRON 4 CUBA PLANA	877033	877039	877036	1146X390X215	160	+2 / +6	230	sin bandejas	24	1.067
IRON 6 CUBA PLANA	877034	877040	877037	1487X390X215	160	+2 / +6	230	sin bandejas	34	1.164
IRON 8 CUBA PLANA	877035	877041	877038	1826X390X215	160	+2 / +6	230	sin bandejas	40	1.279
IRON 6 REMOTA CUBA PLANA	876912	--	--	1146X390X215	160	+2 / +6	230	sin bandejas	32	1.327
IRON 8 REMOTA CUBA PLANA	876913	--	--	1487X390X215	160	+2 / +6	230	sin bandejas	35	1.459

IRON SUSHI

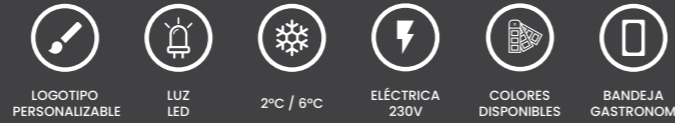

CRISTAL ABATIBLE (FÁCIL LIMPIEZA)
FOLDING GLASS (EASY CLEANING)
VITRE ABATIBLE (FACIL NETTOYAGE)

EVAPORADOR ESTÁTICO
STATIC EVAPORATOR
ÉVAPORATEUR STATIQUE

21 CM PARA APOYAR PLATOS
21 CM TO SUPPORT PLATES
21 CM POUR SUPPORT PLANCHAS

LED ALTA CALIDAD
HIGH QUALITY LED
LED DE HAUTE QUALITÉ

CUBA SIN ÁNGULOS
CUBA WITHOUT ANGLES
CUBA SANS ANGLES



IRON 6 SUSHI

INTERRUPTOR LED
LED SWITCH
INTERRUPTEUR LED

TERMOSTATO DIGITAL REGULABLE
ADJUSTABLE DIGITAL THERMOSTAT
THERMOSTAT DIGITAL RÉGLABLE

PUERTAS CORREDERAS
SLIDING DOORS
PORTES COULISSANTES

INTERRUPTOR GENERAL
GENERAL SWITCH
INTERRUPTEUR GÉNÉRAL

COMPRESOR HERMÉTICO CON CONDENSADOR VENTILADO
HERMETIC COMPRESSOR WITH VENTILATED CONDENSER
COMPRESSEUR HERMÉTIQUE AVEC CONDENSEUR VENTILÉ

BANDEJAS INCLUIDAS
TRAYS INCLUDED
PLATEAUX INCLUS

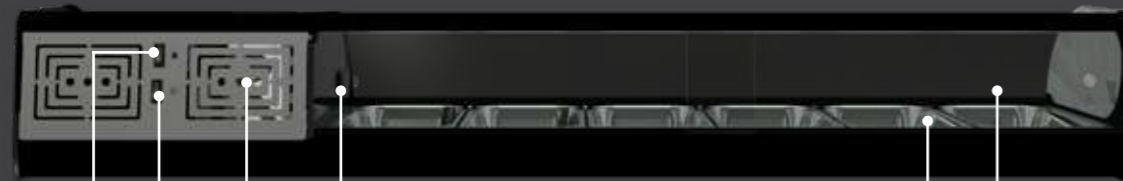

ACCESORIOS NO INCLUIDOS



Ref. 916872
JUEGO SOPORTES 111,21 €



Ref. 905415
KIT DESAGÜE 65,00 €



Ref. 918361
PARRILLAS CUBA PLANA 36,00 €/ud



PARA MOTOR LADO CONTRARIO:
FAMILIA CORAL (PÁGINAS 50-51)

VITRINA REFRIGERADA CON CRISTAL CURVO ABATIBLE
REFRIGERATED DISPLAY CASES WITH CURVE CRYSTAL FOLDABLE
VITRINES RÉFRIGÉRÉES À VITRES COURBÉES PLIANTES

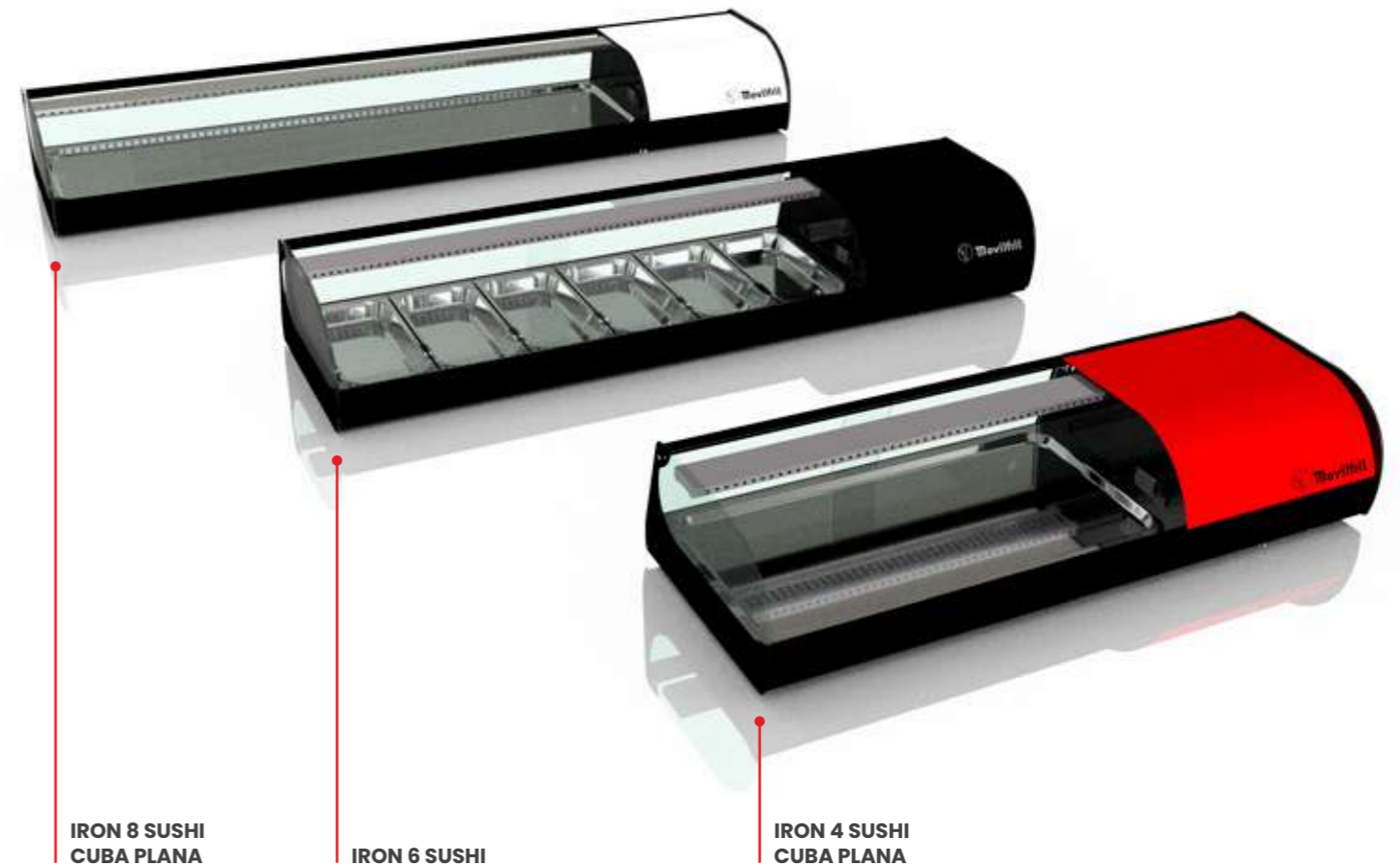

IRON 8 SUSHI
CUBA PLANA

IRON 6 SUSHI

IRON 4 SUSHI
CUBA PLANA

Modelo	Código			Dimensiones L x P x H (mm)	Potencia W	Temperatura °C	Tensión V	Capacidad	Peso kg	Precio €
	●	○	●							
IRON 4 SUSHI	877042	877048	877045	1146X390X215	160	+2 / +6	230	4XGN1/3x40	24	1.213
IRON 6 SUSHI	877043	877049	877046	1487X390X215	160	+2 / +6	230	6XGN1/3x40	34	1.311
IRON 8 SUSHI	877044	877050	877047	1826X390X215	160	+2 / +6	230	8XGN1/3x40	40	1.426
IRON 4 SUSHI CUBA PLANA	877051	877057	877054	1146X390X215	160	+2 / +6	230	sin bandejas	24	1.213
IRON 6 SUSHI CUBA PLANA	877052	877058	877055	1487X390X215	160	+2 / +6	230	sin bandejas	34	1.311
IRON 8 SUSHI CUBA PLANA	877053	877059	877056	1826X390X215	160	+2 / +6	230	sin bandejas	40	1.426

IRON 2 PISOS

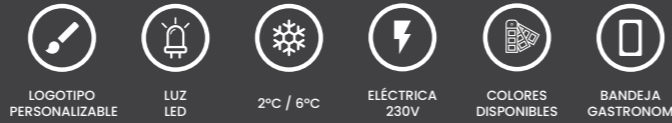

CRISTAL ABATIBLE (FÁCIL LIMPIEZA)
FOLDING GLASS (EASY CLEANING)
VITRE ABATTABLE (FACIL NETTOYAGE)

BANDEJAS INCLUIDAS
TRAYS INCLUDED
PLATEAUX INCLUS

21 CM PARA APOYAR PLATOS
21 CM TO SUPPORT PLATES
21 CM POUR SUPPORT PLANCHAS

LED ALTA CALIDAD
HIGH QUALITY LED
LED DE HAUTE QUALITÉ

CUBA SIN ÁNGULOS
CUBA WITHOUT ANGLES
CUBA SANS ANGLES



IRON 6 2P

INTERRUPTOR LED
LED SWITCH
INTERRUPTEUR LED

TERMOSTATO DIGITAL REGULABLE
ADJUSTABLE DIGITAL THERMOSTAT
THERMOSTAT DIGITAL RÉGLABLE

PUERTAS CORREDERAS
SLIDING DOORS
PORTES COULISSANTES

INTERRUPTOR GENERAL
GENERAL SWITCH
INTERRUPTEUR GÉNÉRAL

COMPRESOR HERMÉTICO CON CONDENSADOR VENTILADO
HERMETIC COMPRESSOR WITH VENTILATED CONDENSER
COMPRESSEUR HERMÉTIQUE AVEC CONDENSEUR VENTILÉ

ESTANTE DE CRISTAL
GLASS SHELF
ÉTAGÈRE EN VITRE

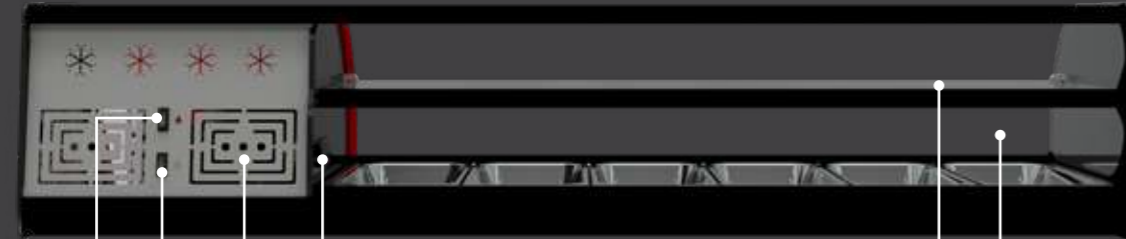

ACCESORIOS NO INCLUIDOS



Ref. 916872
JUEGO SOPORTES 111,21 €



Ref. 905415
KIT DESAGÜE 65,00 €



Ref. 918361
PARRILLAS CUBA PLANA 36,00 €/ud



PARA MOTOR LADO CONTRARIO:
FAMILIA CORAL (PÁGINAS 50-51)

VITRINA REFRIGERADA CON CRISTAL CURVO ABATIBLE
REFRIGERATED DISPLAY CASES WITH CURVE CRYSTAL FOLDABLE
VITRINES RÉFRIGÉRÉES À VITRES COURBÉES ABATTABLE

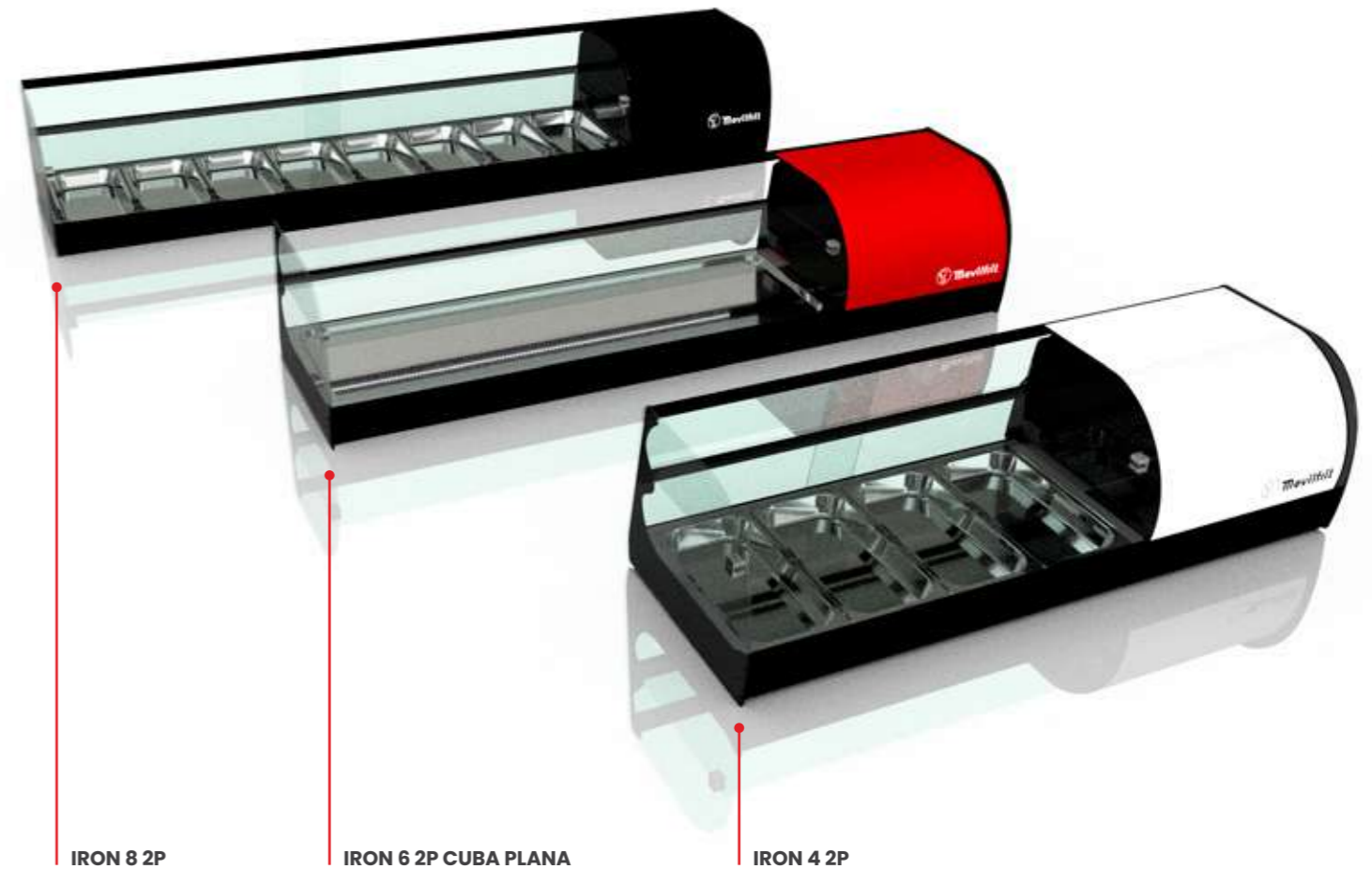

IRON 8 2P

IRON 6 2P CUBA PLANA

IRON 4 2P

Modelo	Código			Dimensiones L x P x H (mm)	Potencia W	Temperatura °C	Tensión V	Capacidad	Peso kg	Precio €
	●	○	●							
IRON 4 2P	877018	877030	877027	1146X390X315	160	+2 / +6	230	4XGN1/3x40	30	1.314
IRON 6 2P	877019	877031	877028	1487X390X315	160	+2 / +6	230	6XGN1/3x40	43	1.420
IRON 8 2P	877020	877032	877029	1826X390X315	160	+2 / +6	230	8XGN1/3x40	51	1.476
IRON 6 2P REMOTA	876916	--	--	1146X390X315	160	+2 / +6	230	6XGN1/3x40	38	1.530
IRON 8 2P REMOTA	876917	--	--	1487X390X315	160	+2 / +6	230	8XGN1/3x40	45	1.681
IRON 4 2P CUBA PLANA	877060	877090	877091	1146X390X315	160	+2 / +6	230	sin bandejas	30	1.314
IRON 6 2P CUBA PLANA	877061	877092	877093	1487X390X315	160	+2 / +6	230	sin bandejas	43	1.420
IRON 8 2P CUBA PLANA	877062	877094	877095	1826X390X315	160	+2 / +6	230	sin bandejas	51	1.476
IRON 6 2P REMOTA CUBA PLANA	876914	--	--	1146X390X315	160	+2 / +6	230	sin bandejas	38	1.530
IRON 8 2P REMOTA CUBA PLANA	876915	--	--	1487X390X315	160	+2 / +6	230	sin bandejas	45	1.681

IRON CALENTADOR



21 CM PARA APOYAR PLATOS
21 CM TO SUPPORT PLATES
21 CM POUR SUPPORT PLANCHAS

BANDEJAS INCLUIDAS
TRAYS INCLUDED
PLATEAUX INCLUS

CRISTAL ABATIBLE (FÁCIL LIMPIEZA)
FOLDING GLASS (EASY CLEANING)
VITRE ABATTABLE (FACIL NETTOYAGE)

INTERRUPTOR GENERAL
GENERAL SWITCH
INTERRUPTEUR GÉNÉRAL

INTERRUPTOR LED
LED SWITCH
INTERRUPTEUR LED

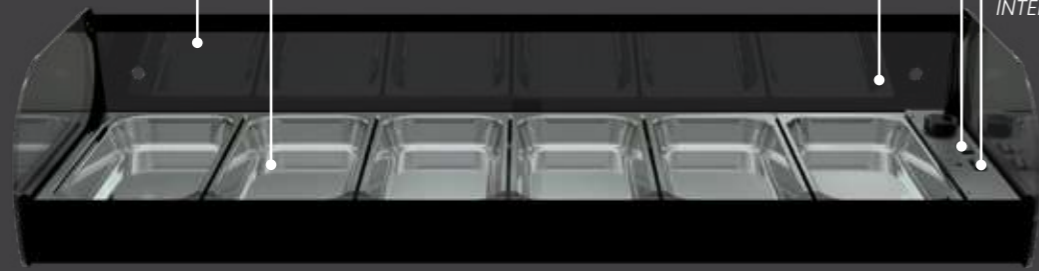

IRON 6 CALENTADOR BAÑO MARIA



CUBA SIN ÁNGULOS
CUBA WITHOUT ANGLES
CUBA SANS ANGLES

PUERTAS CORREDERAS
SLIDING DOORS
PORTES COULISSANTES

TERMOSTATO MANUAL REGULABLE
ADJUSTABLE MANUAL THERMOSTAT
THERMOSTAT MANUEL RÉGLABLE

LED ALTA CALIDAD
HIGH QUALITY LED
LED DE HAUTE QUALITÉ

ACCESORIOS NO INCLUIDOS

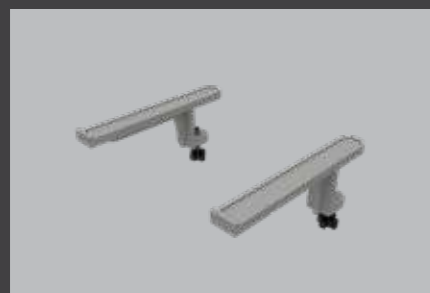

Ref. 916872
JUEGO SOPORTES

111,21 €

VITRINA CALIENTE BAÑO MARIA CRISTAL CURVO ABATIBLE
HOT DISPLAY CASES BAIN MARIE CURVED GLASS FOLDABLE
VITRINES CHAUDES BAIN MARIE VERRE COURBÉ ABATTABLE

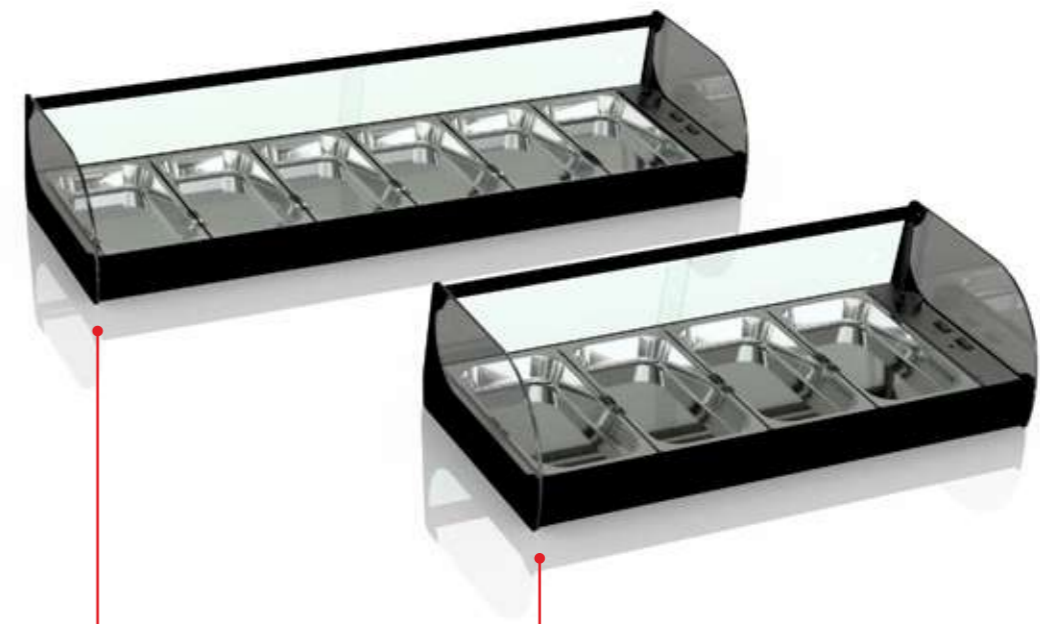

IRON 6 CALENTADOR
BAÑO MARIA

IRON 4 CALENTADOR
BAÑO MARIA

Modelo	Código	Dimensiones L x P x H (mm)	Potencia W	Temperatura °C	Tensión V	Capacidad	Peso kg	Precio €
IRON 4 CALENTADOR BAÑO MARIA	807094	807X390X215	1000	+30 / +90	230	4XGN1/3x40	20	735
IRON 6 CALENTADOR BAÑO MARIA	807095	1146X390X215	1000	+30 / +90	230	6XGN1/3x40	28	900

CORAL

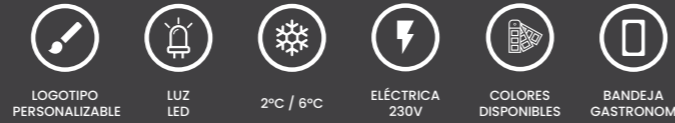

21 CM PARA APOYAR PLATOS
21 CM TO SUPPORT PLATES
21 CM POUR SUPPORT PLANCHAS

BANDEJAS INCLUIDAS
TRAYS INCLUDED
PLATEAUX INCLUS

CRISTAL ABATIBLE (FÁCIL LIMPIEZA)
FOLDING GLASS (EASY CLEANING)
VITRE ABATTABLE (FACIL NETTOYAGE)

CUBA SIN ÁNGULOS
CUBA WITHOUT ANGLES
CUBA SANS ANGLES

LED ALTA CALIDAD
HIGH QUALITY LED
LED DE HAUTE QUALITÉ



CORAL 6



TERMOSTATO DIGITAL REGULABLE
ADJUSTABLE DIGITAL THERMOSTAT
THERMOSTAT DIGITAL RÉGLABLE

INTERRUPTOR LED
LED SWITCH
INTERRUPTEUR LED

PUERTAS CORREDERAS
SLIDING DOORS
PORTES COULISSANTES

COMPRESOR HERMÉTICO CON CONDENSADOR VENTILADO
HERMETIC COMPRESSOR WITH VENTILATED CONDENSER
COMPRESSEUR HERMÉTIQUE AVEC CONDENSEUR VENTILÉ

INTERRUPTOR GENERAL
GENERAL SWITCH
INTERRUPTEUR GÉNÉRAL

ACCESORIOS NO INCLUIDOS

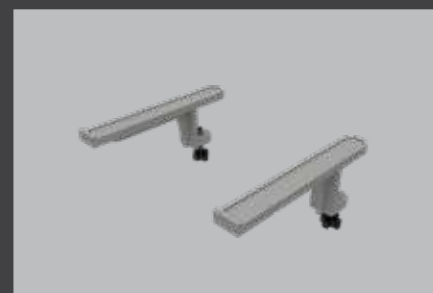

Ref. 916872
JUEGO SOPORTES 111,21 €



Ref. 905415
KIT DESAGÜE 65,00 €



Ref. 918361
PARRILLAS CUBA PLANA 36,00 €/ud

VITRINA REFRIGERADA CON CRISTAL CURVO ABATIBLE REFRIGERATED DISPLAY CASES WITH CURVE CRYSTAL FOLDABLE VITRINES RÉFRIGÉRÉES À VITRES COURBÉES PLIANTES

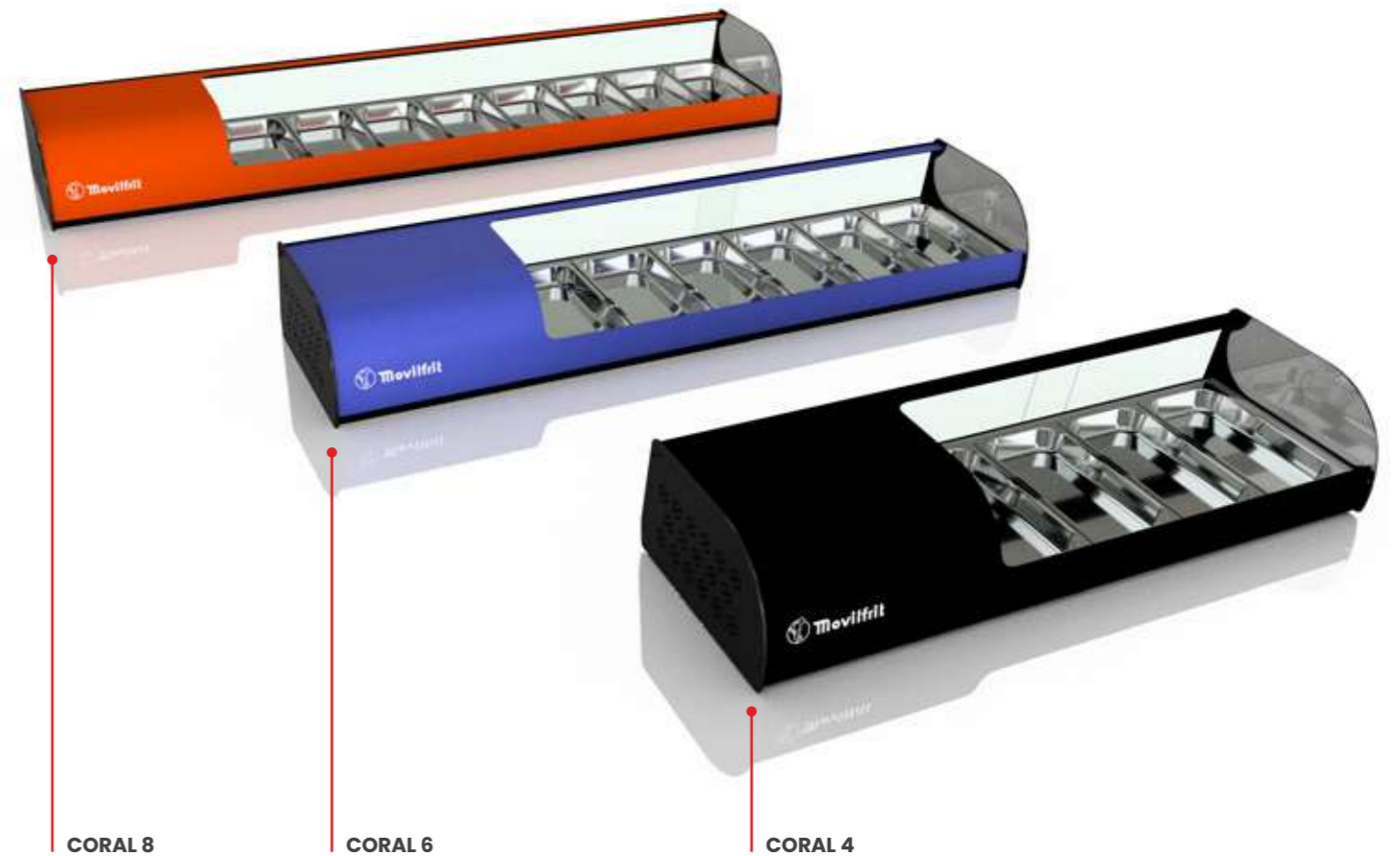

CORAL 8

CORAL 6

CORAL 4

Modelo	Código			Dimensiones L x P x H (mm)	Potencia W	Temperatura °C	Tensión V	Capacidad	Peso kg	Precio €
	●	●	●							
CORAL 4	307100	307101	307102	1146X390X215	160	+2 / +6	230	4XGN1/3x40	24	1.442
CORAL 6	307103	307104	307105	1487X390X215	160	+2 / +6	230	6XGN1/3x40	34	1.590
CORAL 8	307106	307107	307108	1826X390X215	160	+2 / +6	230	8XGN1/3x40	40	1.703
CORAL 4 2P NEW	307120	307121	307122	1146X390X215	160	+2 / +6	230	4XGN1/3x40	24	1.689
CORAL 6 2P NEW	307123	307124	307125	1487X390X215	160	+2 / +6	230	6XGN1/3x40	34	1.846
CORAL 8 2P NEW	307126	307127	307128	1826X390X215	160	+2 / +6	230	8XGN1/3x40	40	1.900

CUB

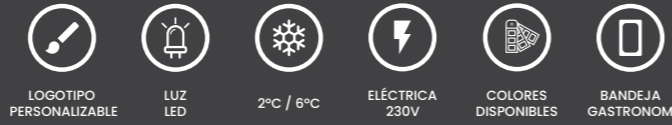

34 CM PARA APOYAR PLATOS
34 CM TO SUPPORT PLATES
34 CM POUR SUPPORT PLANCHAS

BANDEJAS INCLUIDAS
TRAYS INCLUDED
PLATEAUX INCLUS

LED ALTA CALIDAD
HIGH QUALITY LED
LED DE HAUTE QUALITÉ

CUBA SIN ÁNGULOS
CUBA WITHOUT ANGLES
CUBA SANS ANGLES

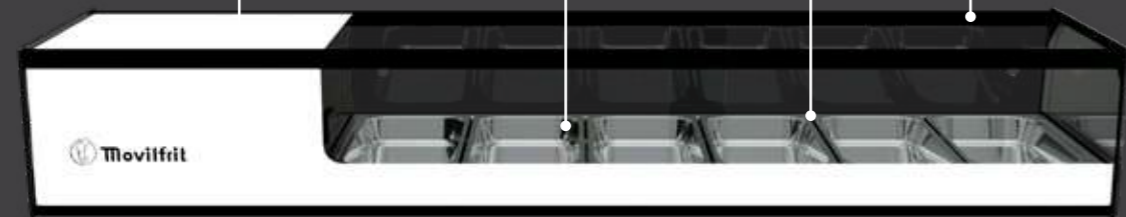

CUB 6

TERMOSTATO DIGITAL REGULABLE
ADJUSTABLE DIGITAL THERMOSTAT
THERMOSTAT DIGITAL RÉGLABLE

INTERRUPTOR LED
LED SWITCH
INTERRUPTEUR LED

PUERTAS CORREDERAS
SLIDING DOORS
PORTES COULISSANTES

COMPRESOR HERMÉTICO CON CONDENSADOR VENTILADO
HERMETIC COMPRESSOR WITH VENTILATED CONDENSER
COMPRESSEUR HERMÉTIQUE AVEC CONDENSEUR VENTILÉ

INTERRUPTOR GENERAL
GENERAL SWITCH
INTERRUPTEUR GÉNÉRAL



ACCESORIOS NO INCLUIDOS



Ref. 916872
JUEGO SOPORTES 111,21 €



Ref. 905415
KIT DESAGÜE 65,00 €



Ref. 918361
PARRILLAS CUBA PLANA 36,00 €/ud



Ref. 300
MOTOR LADO CONTRARIO 75,00 €

VITRINAS REFRIGERADAS CRISTAL PLANO REFRIGERATED DISPLAY CASES FLAT CRYSTAL VITRINES RÉFRIGÉRÉES EN VITRE PLAT

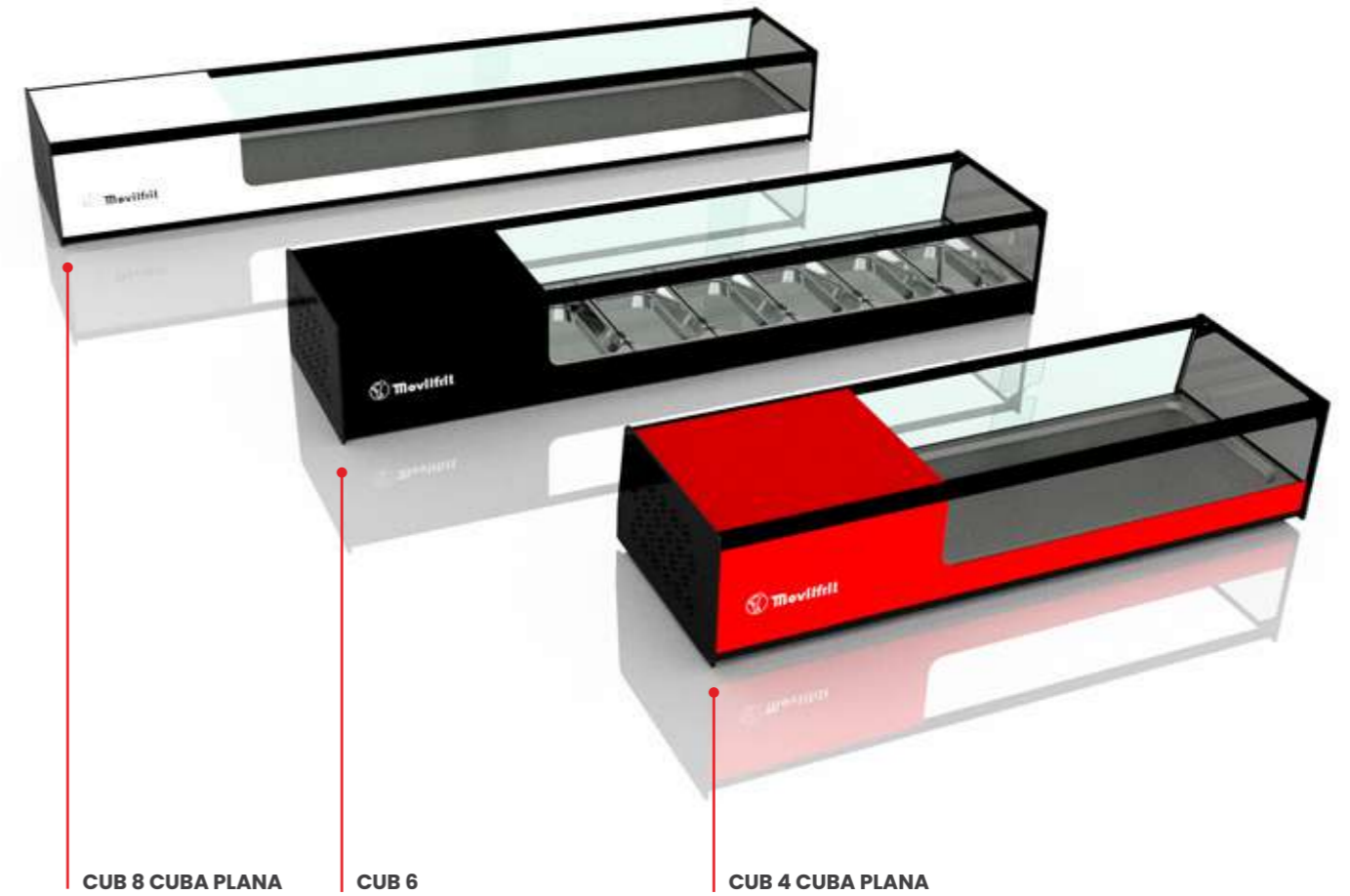

Modelo	Código			Dimensiones L x P x H (mm)	Potencia W	Temperatura °C	Tensión V	Capacidad	Peso kg	Precio €
	●	○	●							
CUB 4	307000	307003	307006	1146X390X252	160	+2 / +6	230	4XGN1/3x40	24	1.262
CUB 6	307001	307004	307007	1487X390X252	160	+2 / +6	230	6XGN1/3x40	34	1.384
CUB 8	307002	307005	307008	1826X390X252	160	+2 / +6	230	8XGN1/3x40	40	1.483
CUB 4 CUBA PLANA	306990	306993	306996	1146X390X252	160	+2 / +6	230	sin bandejas	24	1.262
CUB 6 CUBA PLANA	306991	306994	306997	1487X390X252	160	+2 / +6	230	sin bandejas	34	1.384
CUB 8 CUBA PLANA	306992	306995	306998	1826X390X252	160	+2 / +6	230	sin bandejas	40	1.483
CUB 4 REMOTA	307009	--	--	805X390X252	160	+2 / +6	230	4XGN1/3x40	22	1.416
CUB 6 REMOTA	307010	--	--	1146X390X252	160	+2 / +6	230	6XGN1/3x40	32	1.560
CUB 8 REMOTA	307011	--	--	1487X390X252	160	+2 / +6	230	8XGN1/3x40	38	1.713

CUB SUSHI

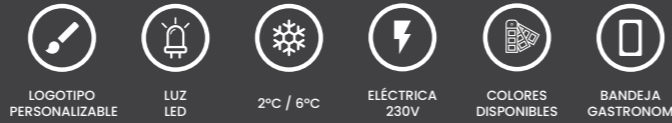

34 CM PARA APOYAR PLATOS
34 CM TO SUPPORT PLATES
34 CM POUR SUPPORT PLANCHAS

BANDEJAS INCLUIDAS
TRAYS INCLUDED
PLATEAUX INCLUS

LED ALTA CALIDAD
HIGH QUALITY LED
LED DE HAUTE QUALITÉ

CUBA SIN ÁNGULOS
CUBA WITHOUT ANGLES
CUBA SANS ANGLES

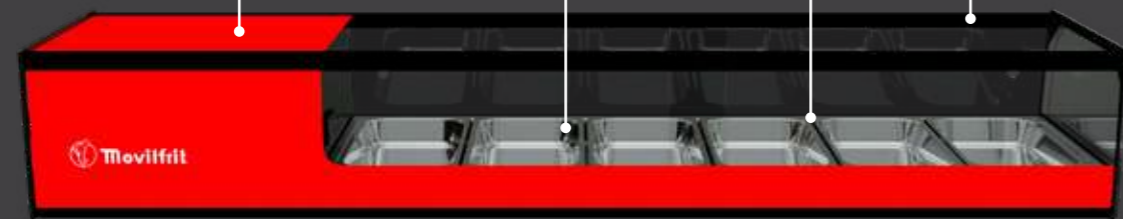

CUB 6 SUSHI

EVAPORADOR ESTÁTICO
STATIC EVAPORATOR
ÉVAPORATEUR STATIQUE

TERMOSTATO DIGITAL REGULABLE
ADJUSTABLE DIGITAL THERMOSTAT
THERMOSTAT DIGITAL RÉGLABLE

INTERRUPTOR LED
LED SWITCH
INTERRUPTEUR LED

PUERTAS CORREDERAS
SLIDING DOORS
PORTES COULISSANTES

COMPRESOR HERMÉTICO CON CONDENSADOR VENTILADO
HERMETIC COMPRESSOR WITH VENTILATED CONDENSER
COMPRESSEUR HERMÉTIQUE AVEC CONDENSEUR VENTILÉ

INTERRUPTOR GENERAL
GENERAL SWITCH
INTERRUPTEUR GÉNÉRAL

ACCESORIOS NO INCLUIDOS



Ref. 916872
JUEGO SOPORTES 111,21 €

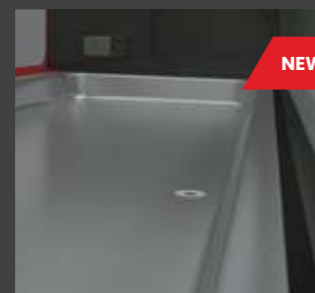

Ref. 905415
KIT DESAGÜE 65,00 €



Ref. 918361
PARRILLAS CUBA PLANA 36,00 €/ud



Ref. 300
MOTOR LADO CONTRARIO 75,00 €

VITRINA REFRIGERADA CRISTAL PLANO REFRIGERATED DISPLAY CASES WITH FLAT CRYSTAL VITRINES RÉFRIGÉRÉES AVEC CRISTAL PLAT



CUB 8 SUSHI

CUB 6 SUSHI CUBA PLANA

CUB 4 SUSHI

Modelo	Código			Dimensiones	Potencia	Temperatura	Tensión	Capacidad	Peso	Precio
	●	○	●	L x P x H (mm)	W	°C	V		kg	€
CUB 4 SUSHI	308010	308013	308016	1146X390X252	160	+2 / +6	230	4XGN1/3x40	24	1.410
CUB 6 SUSHI	308011	308014	308017	1487X390X252	160	+2 / +6	230	6XGN1/3x40	34	1.531
CUB 8 SUSHI	308012	308015	308018	1826X390X252	160	+2 / +6	230	8XGN1/3x40	40	1.638
CUB 4 SUSHI CUBA PLANA	308020	308023	308026	1146X390X252	160	+2 / +6	230	sin bandejas	24	1.410
CUB 6 SUSHI CUBA PLANA	308021	308024	308027	1487X390X252	160	+2 / +6	230	sin bandejas	34	1.531
CUB 8 SUSHI CUBA PLANA	308022	308025	308028	1826X390X252	160	+2 / +6	230	sin bandejas	40	1.638

CUB 2 PISOS

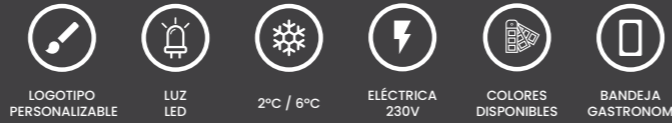

34 CM PARA APOYAR PLATOS
34 CM TO SUPPORT PLATES
34 CM POUR SUPPORT PLANCHAS

BANDEJAS INCLUIDAS
TRAYS INCLUDED
PLATEAUX INCLUS

LED ALTA CALIDAD
HIGH QUALITY LED
LED DE HAUTE QUALITÉ

CUBA SIN ÁNGULOS
CUBA WITHOUT ANGLES
CUBA SANS ANGLES

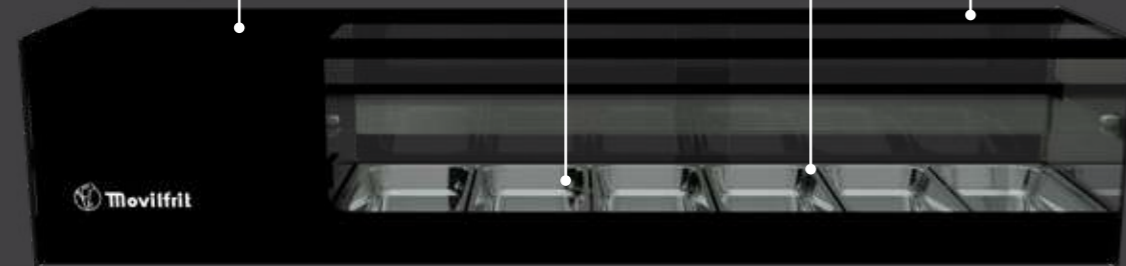

CUB 6 2P

TERMOSTATO DIGITAL REGULABLE
ADJUSTABLE DIGITAL THERMOSTAT
THERMOSTAT DIGITAL RÉGLABLE

INTERRUPTOR LED
LED SWITCH
INTERRUPTEUR LED

PUERTAS CORREDERAS
SLIDING DOORS
PORTES COULISSANTES

COMPRESOR HERMÉTICO CON CONDENSADOR VENTILADO
HERMETIC COMPRESSOR WITH VENTILATED CONDENSER
COMPRESSEUR HERMÉTIQUE AVEC CONDENSEUR VENTILÉ

INTERRUPTOR GENERAL
GENERAL SWITCH
INTERRUPTEUR GÉNÉRAL

ACCESORIOS NO INCLUIDOS



Ref. 916872
JUEGO SOPORTES 111,21 €



Ref. 905415
KIT DESAGÜE 65,00 €



Ref. 918361
PARRILLAS CUBA PLANA 36,00 €/ud



Ref. 300
MOTOR LADO CONTRARIO 75,00 €

VITRINA REFRIGERADA CRISTAL PLANO REFRIGERATED DISPLAY CASES WITH FLAT CRYSTAL VITRINES RÉFRIGÉRÉES AVEC CRISTAL PLAT

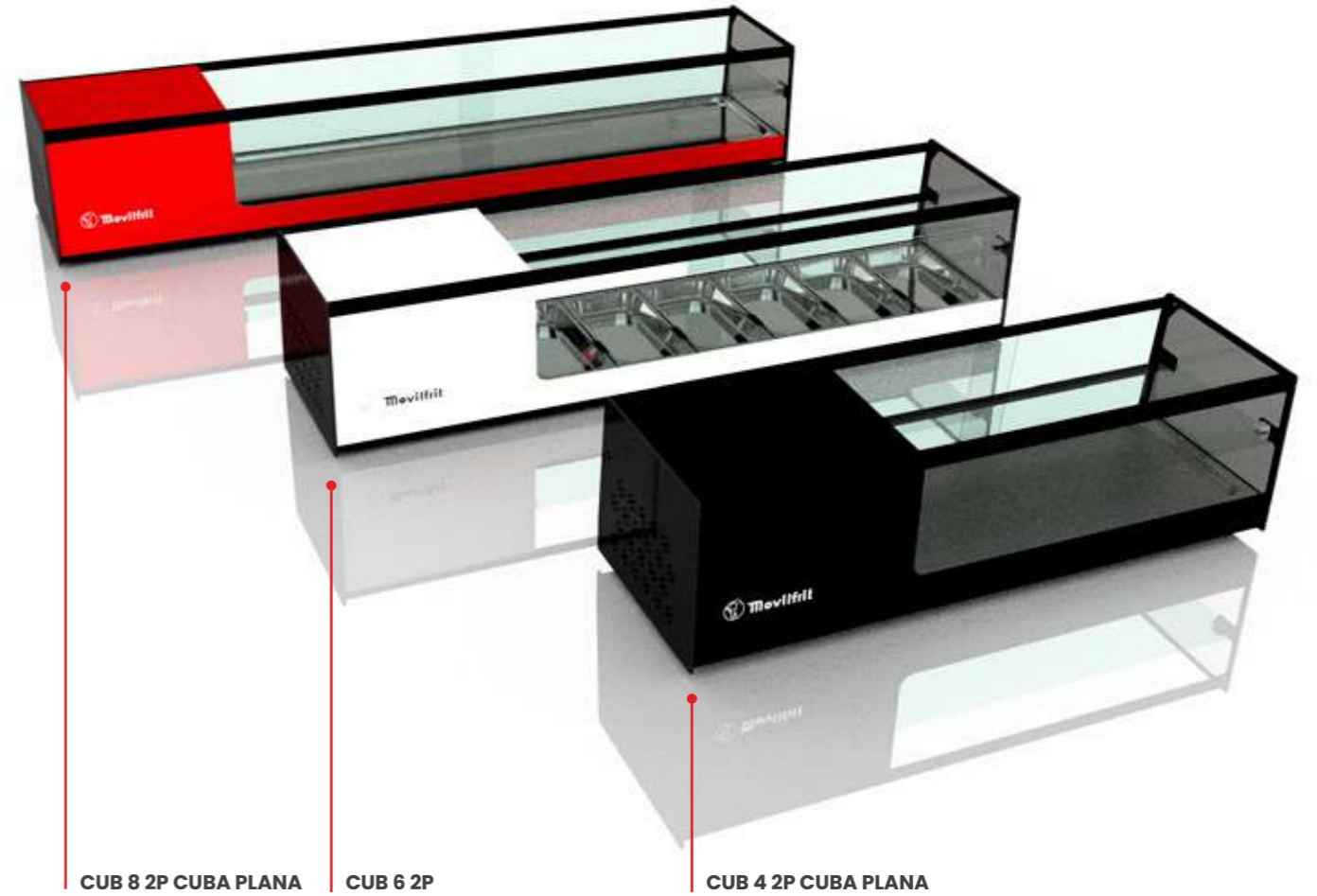

CUB 8 2P CUBA PLANA

CUB 6 2P

CUB 4 2P CUBA PLANA

Modelo	Código			Dimensiones L x P x H (mm)	Potencia W	Temperatura °C	Tensión V	Capacidad	Peso kg	Precio €
	●	○	●							
CUB 4 2P	307069	307075	307078	1146X390X330	160	+2 / +6	230	4XGNI/3x40	24	1.500
CUB 6 2P	307070	307076	307079	1487X390X330	160	+2 / +6	230	6XGNI/3x40	34	1.628
CUB 8 2P	307071	307077	307080	1826X390X330	160	+2 / +6	230	8XGNI/3x40	40	1.744
CUB 4 2P CUBA PLANA	307074	307081	307084	1146X390X330	160	+2 / +6	230	sin bandejas	24	1.500
CUB 6 2P CUBA PLANA	307072	307082	307085	1487X390X330	160	+2 / +6	230	sin bandejas	34	1.628
CUB 8 2P CUBA PLANA	307073	307083	307086	1826X390X330	160	+2 / +6	230	sin bandejas	40	1.744
CUB 4 2P REMOTA	307012	--	--	805X390X330	160	+2 / +6	230	4XGNI/3x40	22	1.681
CUB 6 2P REMOTA	307013	--	--	1146X390X330	160	+2 / +6	230	6XGNI/3x40	32	1.786
CUB 8 2P REMOTA	307014	--	--	1487X390X330	160	+2 / +6	230	8XGNI/3x40	38	1.843

CUB COLD 2 PISOS



34 CM PARA APOYAR PLATOS
34 CM TO SUPPORT PLATES
34 CM POUR SUPPORT PLANCHAS

CUBA SIN ÁNGULOS
CUBA WITHOUT ANGLES
CUBA SANS ANGLES

BANDEJAS INCLUIDAS
TRAYS INCLUDED
PLATEAUX INCLUS

LED ALTA CALIDAD
HIGH QUALITY LED
LED DE HAUTE QUALITÉ

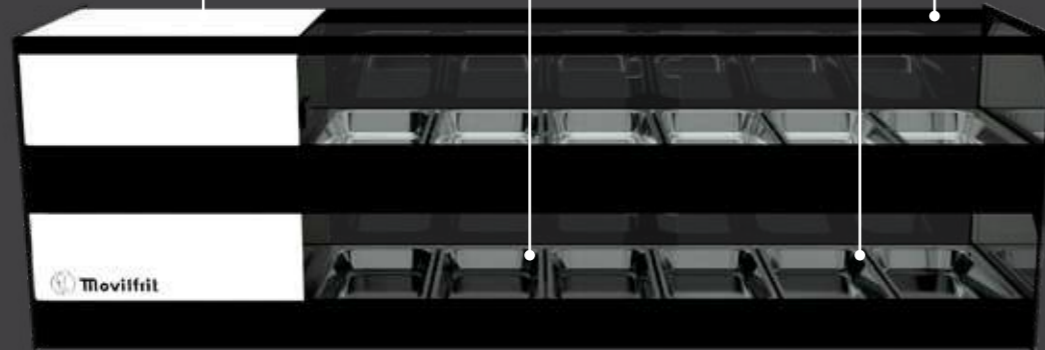

CUB COLD 6 2P



CUB COLD 4 2P

PUERTAS CORREDERAS
SLIDING DOORS
PORTES COULISSANTES

COMPRESOR HERMÉTICO CON CONDENSADOR VENTILADO
HERMETIC COMPRESSOR WITH VENTILATED CONDENSER
COMPRESSEUR HERMÉTIQUE AVEC CONDENSEUR VENTILÉ

INTERRUPTOR GENERAL
GENERAL SWITCH
INTERRUPTEUR GÉNÉRAL

TERMOSTATO DIGITAL REGULABLE
ADJUSTABLE DIGITAL THERMOSTAT
THERMOSTAT DIGITAL RÉGLABLE

INTERRUPTOR LED
LED SWITCH
INTERRUPTEUR LED

ACCESORIOS NO INCLUIDOS



Ref. 916872
JUEGO SOPORTES 111,21 €

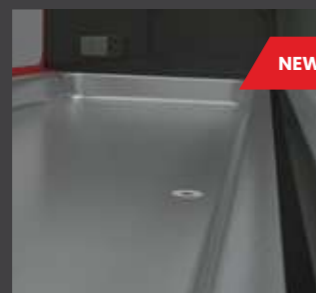

Ref. 905415
KIT DESAGÜE 65,00 €



Ref. 918361
PARRILLAS CUBA PLANA 36,00 €/ud



Ref. 300
MOTOR LADO CONTRARIO 75,00 €

VITRINA REFRIGERADA DOBLE FRIO CRISTAL PLANO
REFRIGERATED DOUBLE COLD DISPLAY CASES WITH FLAT CRYSTAL
VITRINES RÉFRIGÉRÉES DOUBLE FROID AVEC CRISTAL PLAT

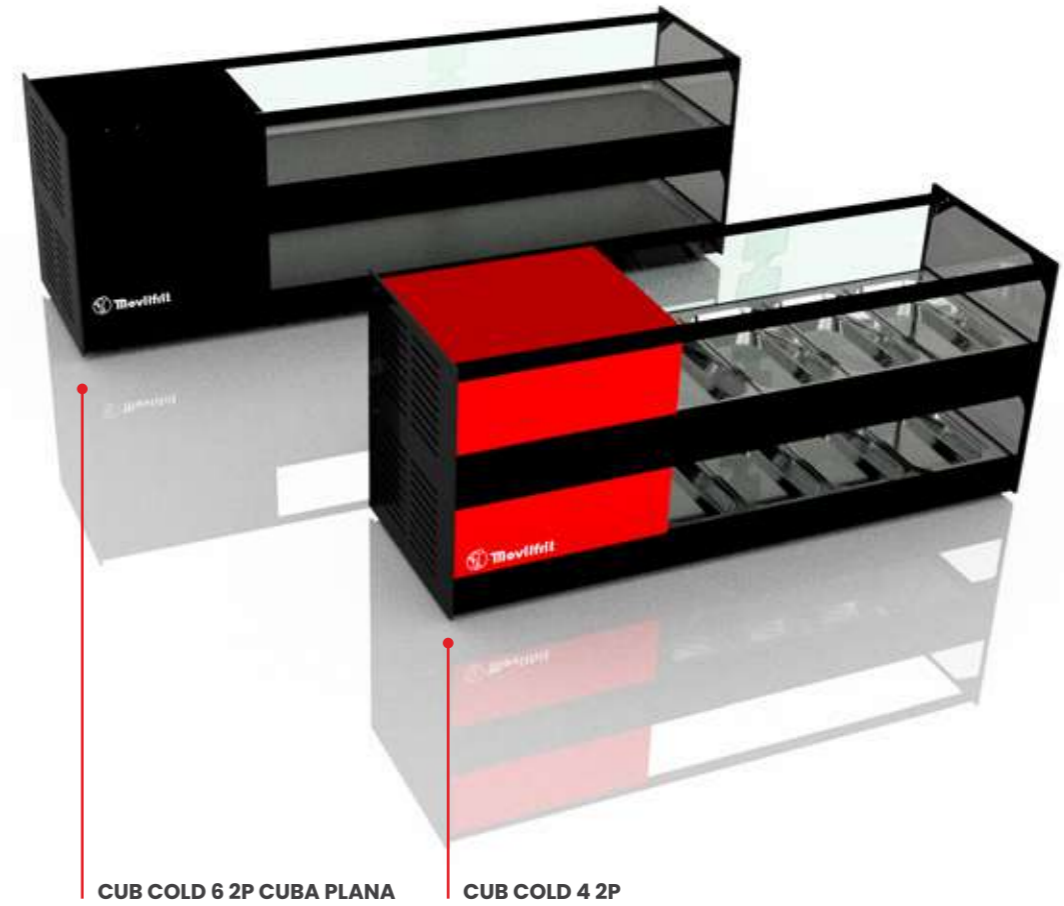

VITRINAS CRISTAL PLANO · STRAIGHT GLASS DISPLAY CASES · VITRINES VITRE PLAT

Modelo	Código			Dimensiones	Potencia	Temperatura	Tensión	Capacidad	Peso	Precio
	●	○	●	L x P x H (mm)	W	°C	V		kg	€
CUB COLD 4 2P	306984	306985	306986	1146X390X515	320	+2 / +6	230	4XGN1/3x40	48	2.279
CUB COLD 6 2P	306987	306988	306989	1487X390X515	320	+2 / +6	230	6XGN1/3x40	68	2.480

CUB TOP

- LOGOTIPO PERSONALIZABLE
- LUZ LED
- 2°C / 6°C
- ELÉCTRICA 230V
- COLORES DISPONIBLES
- BANDEJA GASTRONOM

34 CM PARA APOYAR PLATOS
34 CM TO SUPPORT PLATES
34 CM POUR SUPPORT PLANCHAS

CUBA SIN ÁNGULOS
CUBA WITHOUT ANGLES
CUBA SANS ANGLES

BANDEJAS INCLUIDAS
TRAYS INCLUDED
PLATEAUX INCLUS

SISTEMA ANTI-GOTEO
ANTI-DROP SYSTEM
SYSTÈME ANTI-GOUTTE

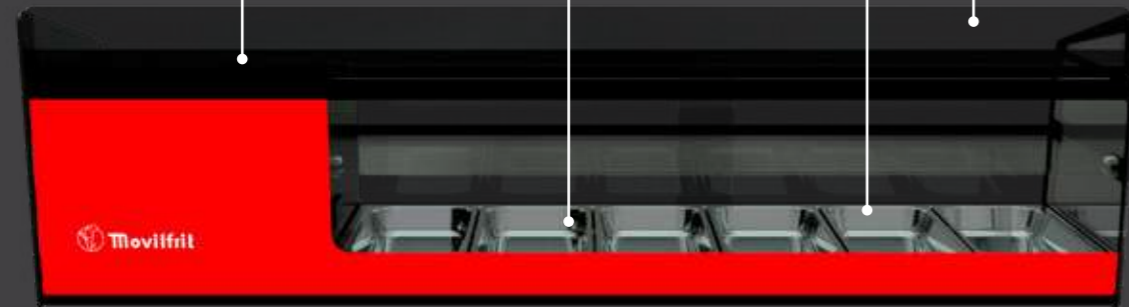

CUB TOP 6

LED ALTA CALIDAD
HIGH QUALITY LED
LED DE HAUTE QUALITÉ

TERMOSTATO DIGITAL REGULABLE
ADJUSTABLE DIGITAL THERMOSTAT
THERMOSTAT DIGITAL RÉGLABLE

INTERRUPTOR LED
LED SWITCH
INTERRUPTEUR LED

PUERTAS CORREDERAS
SLIDING DOORS
PORTES COULISSANTES

COMPRESOR HERMÉTICO CON CONDENSADOR VENTILADO
HERMETIC COMPRESSOR WITH VENTILATED CONDENSER
COMPRESSEUR HERMÉTIQUE AVEC CONDENSEUR VENTILÉ

INTERRUPTOR GENERAL
GENERAL SWITCH
INTERRUPTEUR GÉNÉRAL

ACCESORIOS NO INCLUIDOS



Ref. 916872
JUEGO SOPORTES 111,21 €



Ref. 905415
KIT DESAGÜE 65,00 €



Ref. 918361
PARRILLAS CUBA PLANA 36,00 €/ud



Ref. 300
MOTOR LADO CONTRARIO 75,00 €

VITRINA REFRIGERADA CRISTAL PLANO REFRIGERATED DISPLAY CASES WITH FLAT CRYSTAL VITRINES RÉFRIGÉRÉES AVEC CRISTAL PLAT

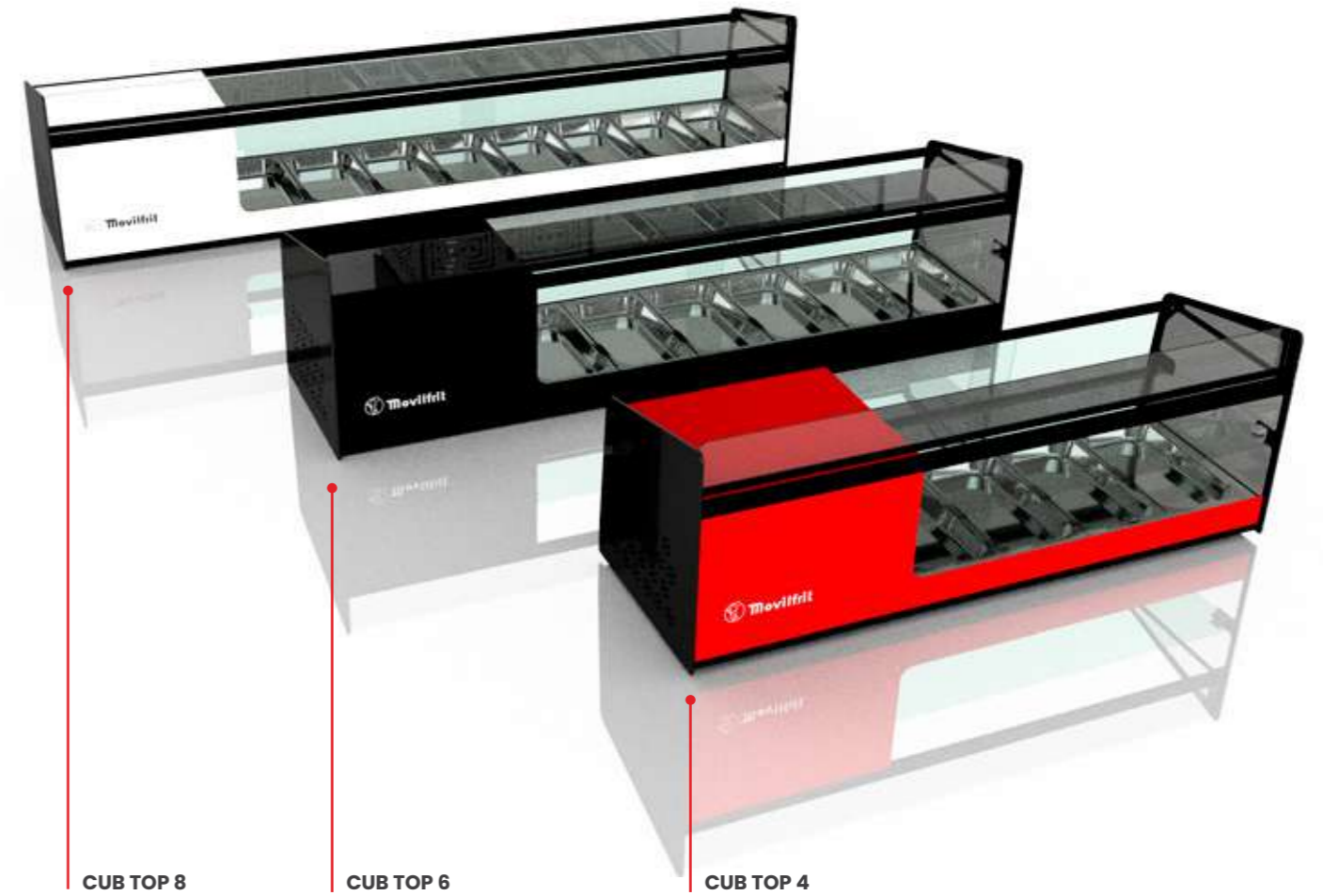

CUB TOP 8

CUB TOP 6

CUB TOP 4

Modelo	Código			Dimensiones	Potencia	Temperatura	Tensión	Capacidad	Peso	Precio
	●	○	●	L x P x H (mm)	W	°C	V		kg	€
CUB TOP 4	308000	308001	308002	1146X390X405	160	+2 / +6	230	4XGNI/3x40	24	1.634
CUB TOP 6	308003	308004	308005	1487X390X405	160	+2 / +6	230	6XGNI/3x40	34	1.762
CUB TOP 8	308006	308007	308008	1826X390X405	160	+2 / +6	230	8XGNI/3x40	40	1.879

CUB CALENTADOR

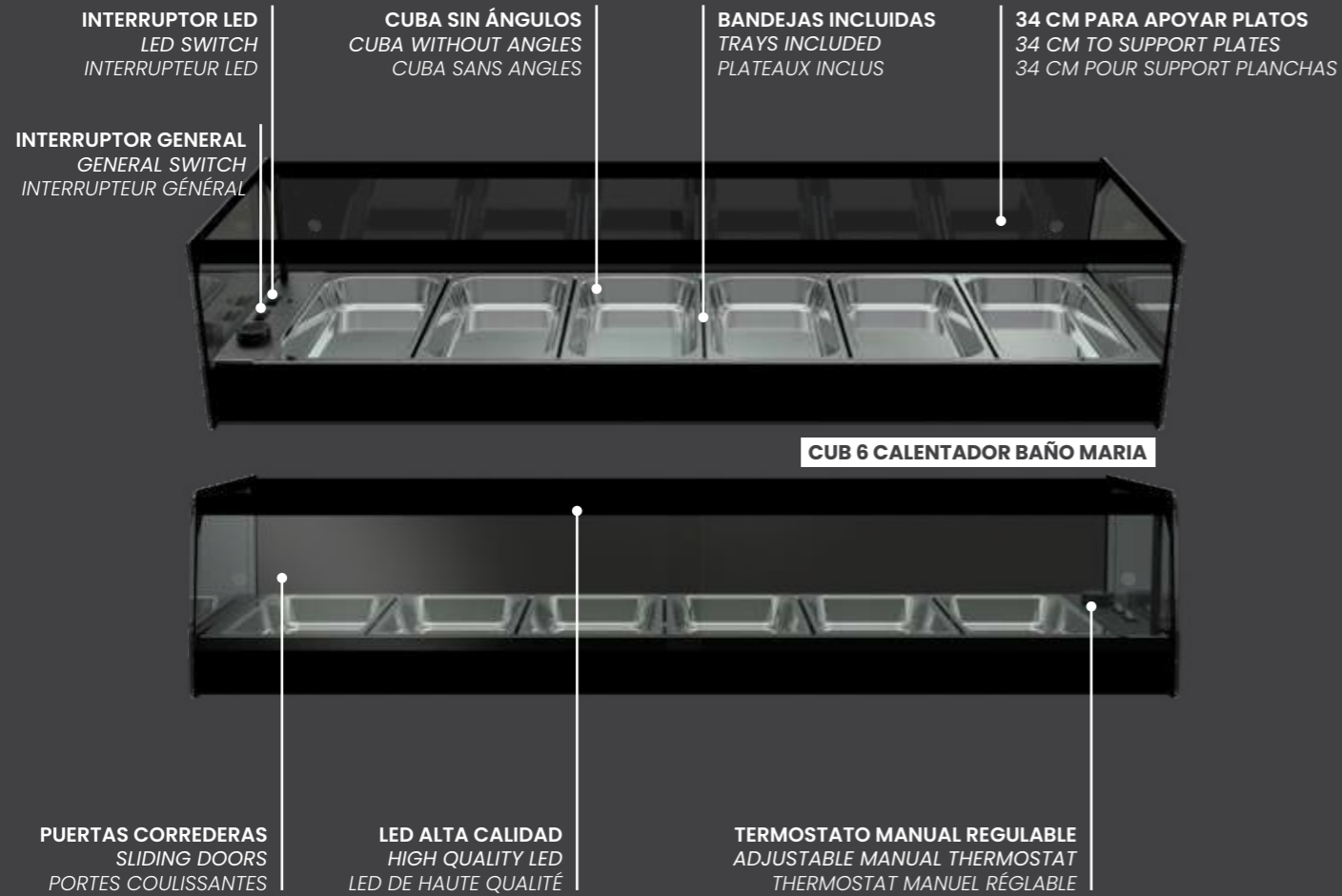

ACCESORIOS NO INCLUIDOS

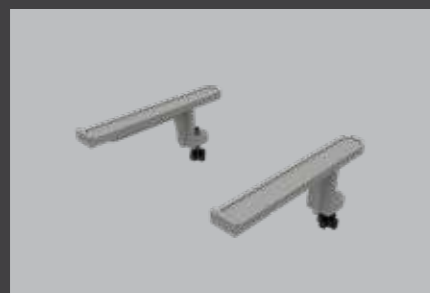

Ref. 916872
JUEGO SOPORTES 111,21 €

VITRINA CALIENTE BAÑO MARIA CRISTAL PLANO
HOT DISPLAY CASES BAIN MARIE WITH FLAT CRYSTAL
VITRINES CHAUDES BAIN MARIE AVEC CRISTAL PLAT

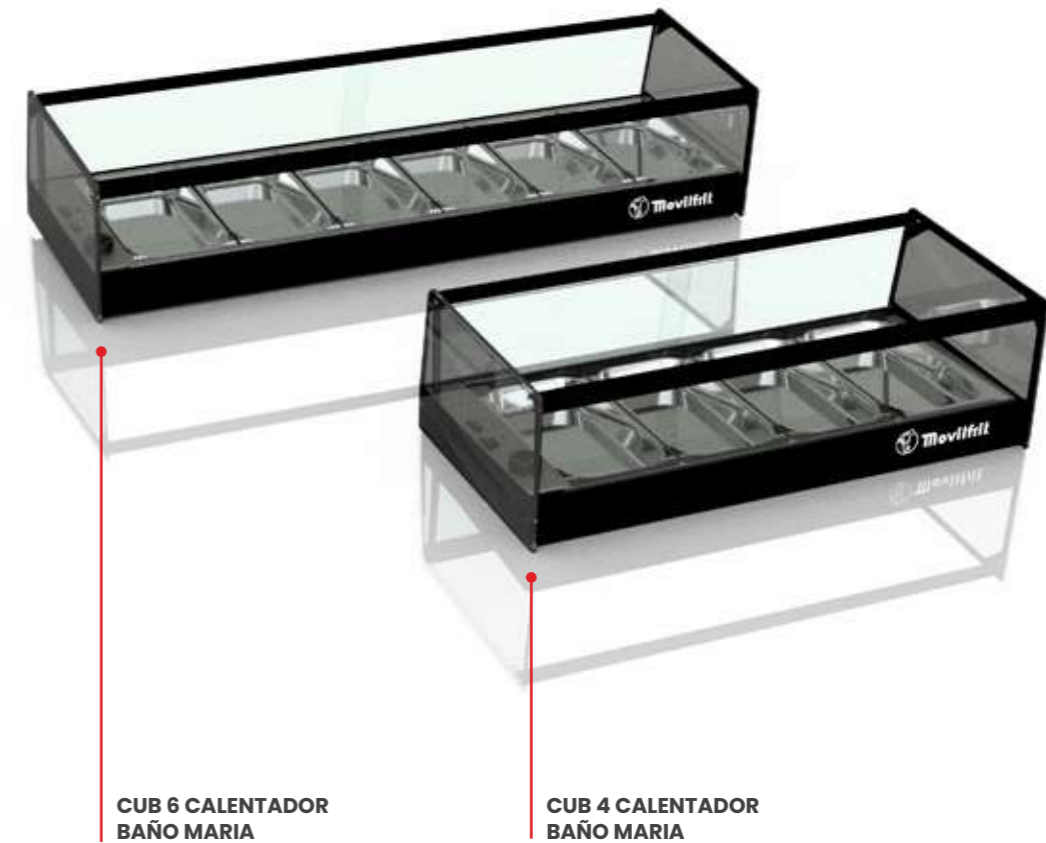

Modelo	Código	Dimensiones L x P x H (mm)	Potencia W	Temperatura °C	Tensión V	Capacidad	Peso kg	Precio €
CUB 4 CALENTADOR BAÑO MARIA	807096	807X390X252	260	+30 / +90	230	4XGN1/3x40	20	890
CUB 6 CALENTADOR BAÑO MARIA	807097	1146X390X252	340	+30 / +90	230	6XGN1/3x40	28	970

EXPOSITOR

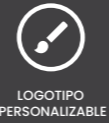

34 CM PARA APOYAR PLATOS
34 CM TO SUPPORT PLATES
34 CM POUR SUPPORT PLANCHAS

BANDEJAS ACERO INOXIDABLE AISI304
AISI304 STAINLESS STEEL TRAYS
PLATEAUX EN ACIER INOXYDABLE AISI304

EXPOSITOR 6 NEUTRO 2 PISO PLANO FONDO 390



EXPOSITOR NEUTRO 2 PISOS PLANO

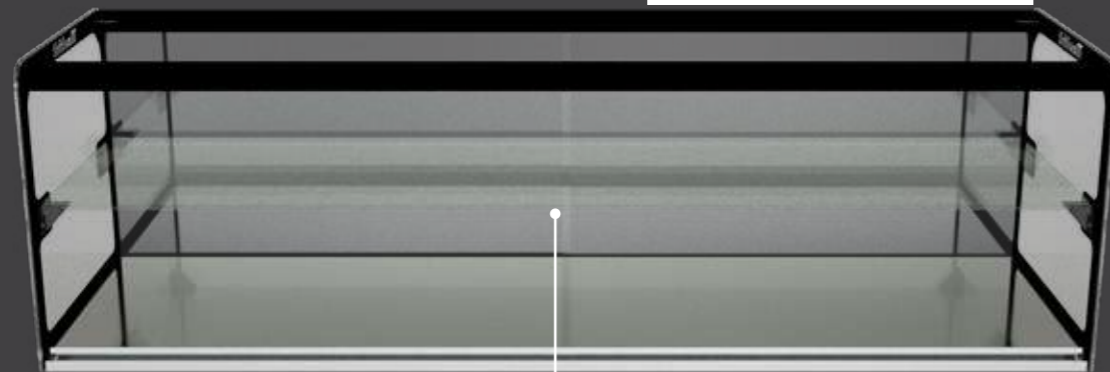

PUERTAS CORREDERAS
SLIDING DOORS
PORTES COULISSANTES

VITRINA EXPOSITOR NEUTRO NEUTRAL DISPLAY CASES VITRINE NEUTRE



EXPOSITOR NEUTRO
1 PISO PLANO



EXPOSITOR NEUTRO
2 PISOS CURVADO



Modelo	Código	Dimensiones L x P x H (mm)	Capacidad	Peso kg	Precio €
EXPOSITOR NEUTRO 1 PISO PLANO DESMONTADO NEW	306541	1010X300X200	sin bandejas	6	240
EXPOSITOR NEUTRO 2 PISOS PLANO DESMONTADO NEW	306542	1010X300X300	sin bandejas	7	352
EXPOSITOR NEUTRO 1 PISO PLANO	306551	1010X300X200	sin bandejas	6	271
EXPOSITOR NEUTRO 1 PISO CURVADO	306550	1010X300X200	sin bandejas	6	280
EXPOSITOR NEUTRO 2 PISOS PLANO	306553	1010X300X300	sin bandejas	7	389
EXPOSITOR NEUTRO 2 PISOS CURVADO	306552	1010X300X300	sin bandejas	7	383

EXPOSITOR 8 NEUTRO
2 PISO PLANO
FONDO 390

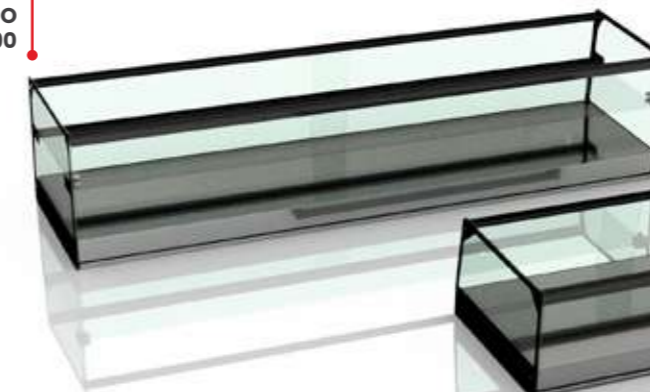

EXPOSITOR 4 NEUTRO
1 PISO PLANO
FONDO 390



Modelo	Código	Dimensiones L x P x H (mm)	Capacidad	Peso kg	Precio €
EXPOSITOR 4 NEUTRO 1 PISO PLANO FONDO 390 NEW	307026	752X390X224	sin bandejas	15	350
EXPOSITOR 6 NEUTRO 1 PISO PLANO FONDO 390 NEW	307027	1092X390X224	sin bandejas	23	422
EXPOSITOR 8 NEUTRO 1 PISO PLANO FONDO 390 NEW	307028	1432X390X224	sin bandejas	30	498
EXPOSITOR 4 NEUTRO 2 PISO PLANO FONDO 390 NEW	307029	752X390X330	sin bandejas	17	450
EXPOSITOR 6 NEUTRO 2 PISO PLANO FONDO 390 NEW	307030	1092X390X330	sin bandejas	25	522
EXPOSITOR 8 NEUTRO 2 PISOS PLANO FONDO 390 NEW	307031	1432X390X330	sin bandejas	32	598

ENCIMERA



TERMOSTATO DIGITAL REGULABLE
ADJUSTABLE DIGITAL THERMOSTAT
THERMOSTAT DIGITAL RÉGLABLE

AISLAMIENTO 30 mm
INSULATION 30 MM
ISOLATION 30 mm

ENCIMERA 1500 CON GRUPO MOTOR

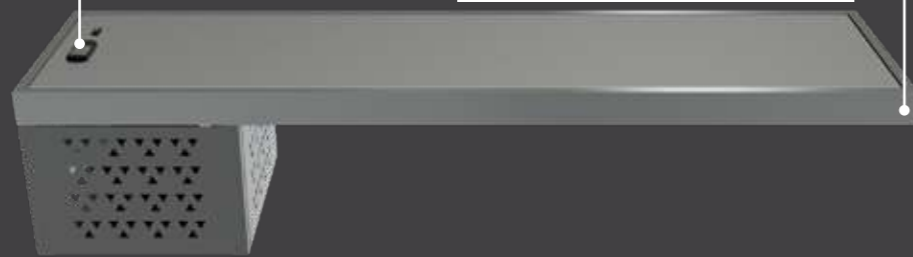

INTERRUPTOR GENERAL
GENERAL SWITCH
INTERRUPTEUR GÉNÉRAL

ENCIMERA 1500 SIN GRUPO MOTOR



BANDEJA PLANA ACERO INOXIDABLE AISI304
AISI304 STAINLESS STEEL FLAT TRAY
PLATEAU PLAT EN ACIER INOXYDABLE AISI304

ACABADO EXTERIOR EN TUBO PERIMETRAL DE ACERO INOXIDABLE AISI304
EXTERIOR FINISHING IN AISI304 STAINLESS STEEL PERIMETER TUBE
FINITION EXTÉRIEURE EN TUBE PÉRIMÉTRIQUE EN ACIER INOXYDABLE AISI304

ENCIMERAS COUNTERTOP BASE FROIDE

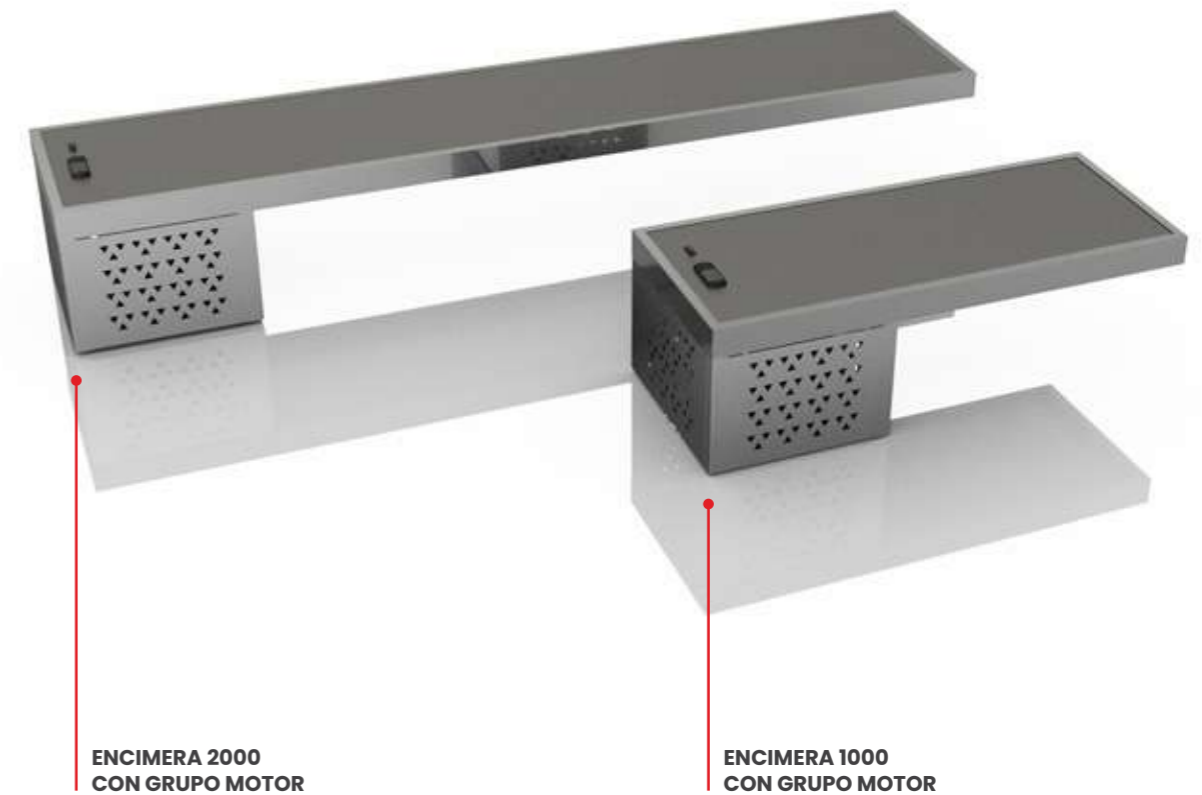

ENCIMERA 2000
CON GRUPO MOTOR

ENCIMERA 1000
CON GRUPO MOTOR

Modelo	Código	Dimensiones L x P x H (mm)	Potencia W	Temperatura °C	Tensión V	Grupo Motor	Peso kg	Precio €
ENCIMERA 1000 SIN GRUPO MOTOR	306561	1000X400X50	--	--	230	NO	5	1.041
ENCIMERA 1500 SIN GRUPO MOTOR	306562	1500X400X50	--	--	230	NO	7	1.203
ENCIMERA 2000 SIN GRUPO MOTOR	306563	2000X400X50	--	--	230	NO	9	1.368
ENCIMERA 1000 CON GRUPO MOTOR	306564	1000X400X330	160	+2 / +6	230	SI	10	1.310
ENCIMERA 1500 CON GRUPO MOTOR	306565	1500X400X330	160	+2 / +6	230	SI	12	1.472
ENCIMERA 2000 CON GRUPO MOTOR	306566	2000X400X330	160	+2 / +6	230	SI	14	1.636



BRASA

CHARCOAL · BRAISE

HORNOS BRASA AIRE
CHARCOAL OVENS AIR
FOURS BRAISE AIR

HORNOS BRASA
CHARCOAL OVEN
FOURS BRAISE

BARBACOAS BRASA
EMBER BARBECUES
BRABECUES BRAISE

HBA



HORNO BRASA ABIERTO – AIRE
OPEN CHARCOAL OVEN – AIR
FOUR À CHARBON OUVERT – AIR



ACCESORIOS NO INCLUIDOS

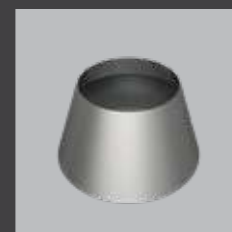

Ref. 202801
SOMBRERO

Dimensiones:
Ø245x170
precio: 257€

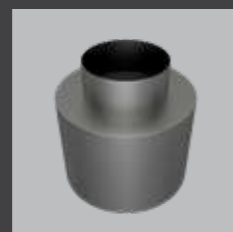

Ref. 202802
CORTAFUEGOS
EXTERNO

Dimensiones:
Ø255x215
precio: 393€

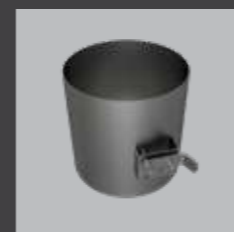

Ref. 202803
REGULADOR DE TIRO
EXTERNO

Dimensiones:
Ø158x170
precio: 289€

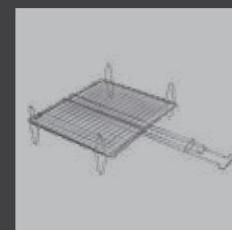

Ref. 202805
PARRILLA
PESCADO

Dimensiones:
300x350x125
precio: 65€

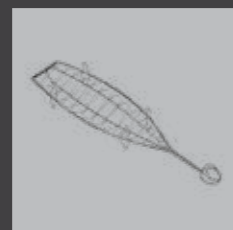

Ref. 202806
PARRILLA
BESUGUERA

Dimensiones:
540x135x125
precio: 45€

HBA 30



Modelo	Código	Dimensiones L x P x H (mm)	Producción Kg/h	Potencia Kw	Temperatura °C	Consumo Kg/día	Autonomía Horas	Carga Kg (carbón)	Peso kg	Precio €
HBA 30	202110	680X535X670	70	4,5	250 - 350	10 - 12	9	3	117	4.184

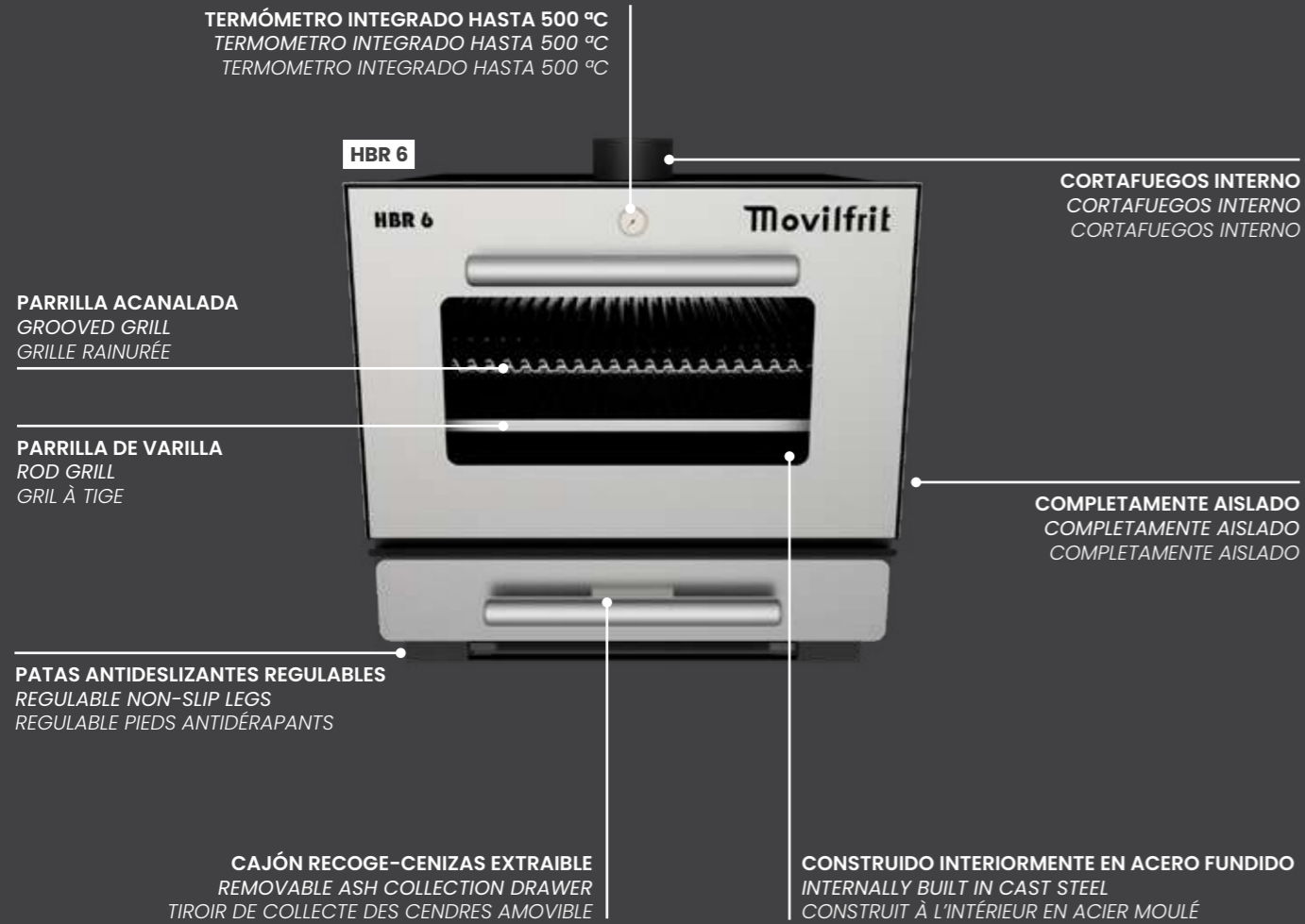

ACCESORIOS NO INCLUIDOS



HORNO COMPACTO COMPACT OVEN FOUR COMPACT

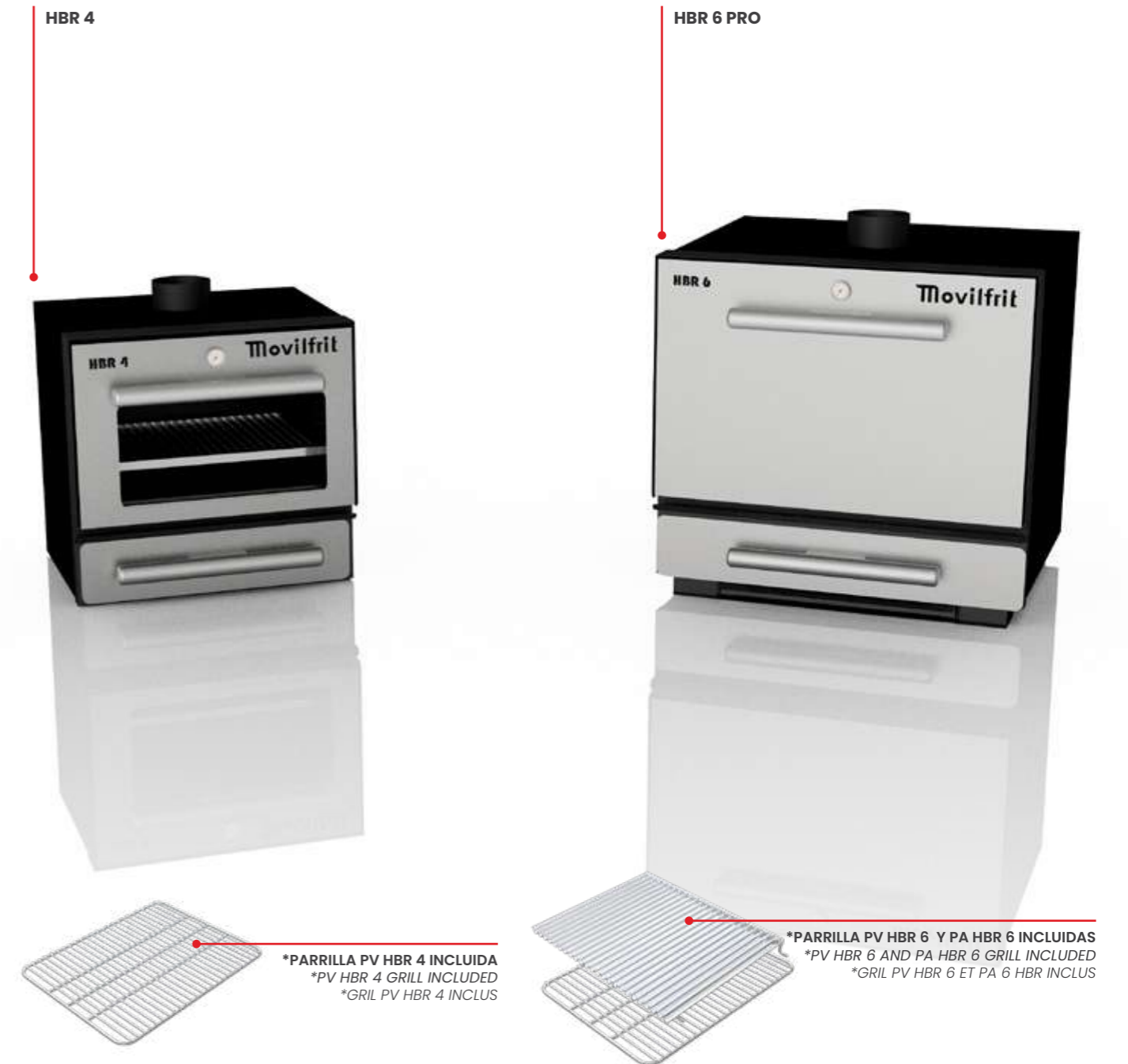

Modelo	Código	Dimensiones L x P x H (mm)	Producción Kg/h	Potencia Kw	Temperatura °C	Consumo Kg/día	Autonomía Horas	Carga Kg (carbón)	Peso kg	Precio €
HBR 4	NEW 202100	680x535x670	70	4,5	250 - 350	10 - 12	9	3	117	5.420
HBR 6	NEW 202102	900x790x900	90	5,5	250 - 350	12- 16	9	4	244	6.719
HBR 4 PRO	NEW 202103	680x535x670	70	4,5	250 - 350	10 - 12	9	3	117	5.200
HBR 6 PRO	NEW 202105	900x790x900	90	5,5	250 - 350	12- 16	9	4	244	6.508



PARRILLA INOXIDABLE
STAINLESS GRILL
GRIL INOX

3 ALTURAS DE PARRILLA
3 GRILL HEIGHTS
3 HAUTEURS DE GRIL

CAJÓN RECOGE-CENIZAS EXTRAIBLE
REMOVABLE ASH COLLECTION DRAWER
TIROIR DE COLLECTE DES CENDRES AMOVIBLE



BARBACOAS BRASA · EMBER BARBECUE · BARBECUE BRAISE

ACCESORIOS NO INCLUIDOS



Ref. 202805
PARRILLA
PESCADO
Dimensiones:
300x350x125
precio: 65€

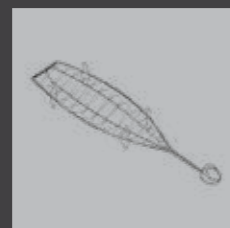

Ref. 202806
PARRILLA
BESUGUERA
Dimensiones:
540x135x125
precio: 45€

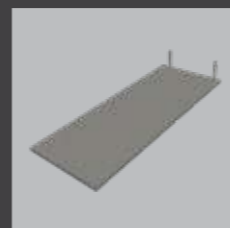

Ref. 202821
PLANCHA
M80/M160
Dimensiones:
585x435 mm
precio: 200€

Modelo	Código	Dimensiones L x P x H (mm)	Producción Kg/h	Potencia Kw	Temperatura °C	Consumo Kg/día	Autonomía Horas	Carga Kg (carbón)	Peso kg	Precio €
BM 80	NEW 202120	800x820x930	90	5,5	250-350	12-16	9	4	240	7.823
BM 160	NEW 202121	1455x820x930	180	11	250-350	24-32	9	8	410	9.008
BS 45	202400	480x660x350	50	3	250-350	8-10	4	2	38	2.664



MODULAR

MODULAR · MODULAR

LÍNEA MODULAR 630
MODULAR LINE 630
LIGNE MODULAIRE 630

MODULAR 630

LÍNEA MODULAR 630
MODULAR LINE 630
LIGNE MODULAIRE 630

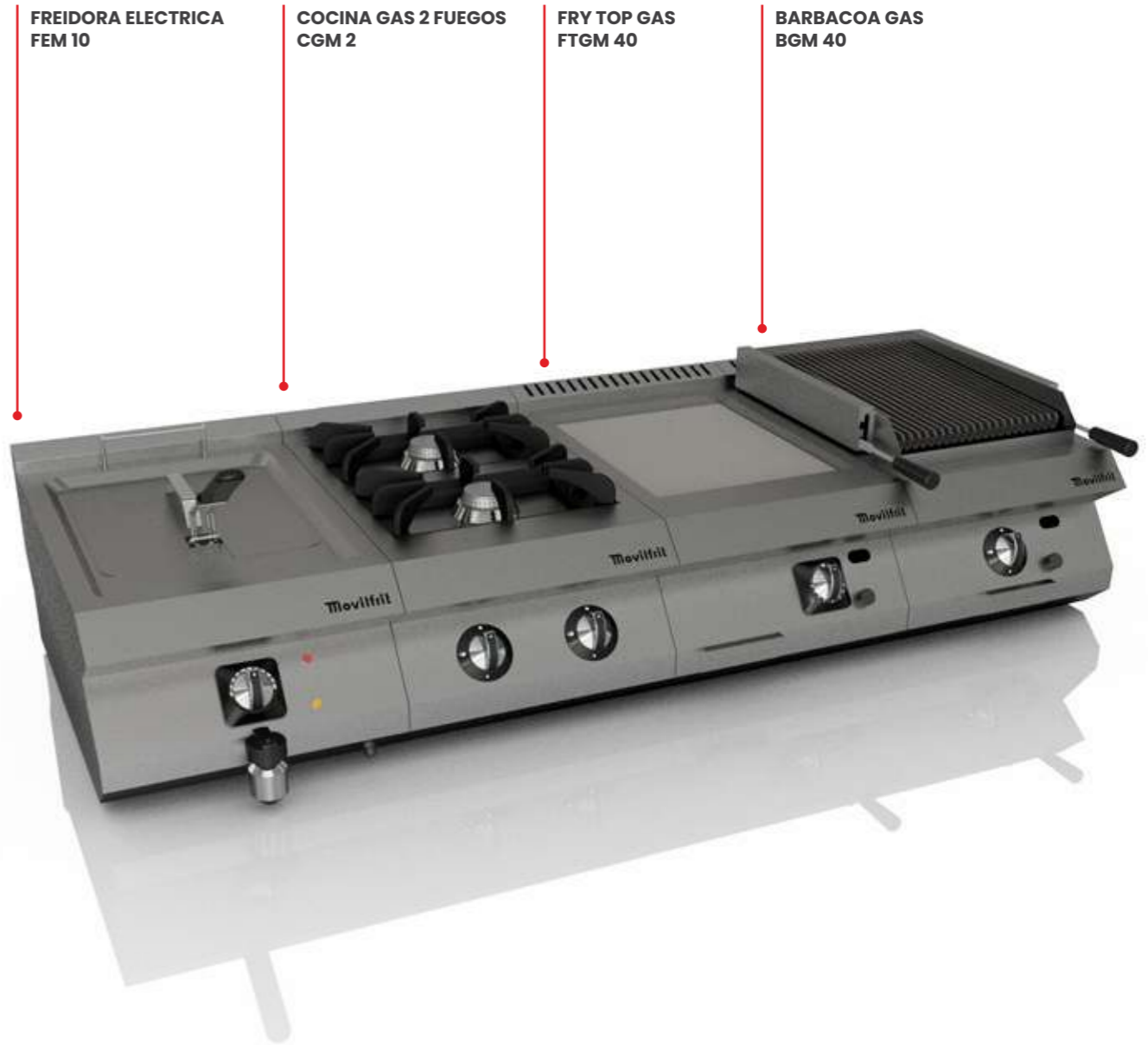
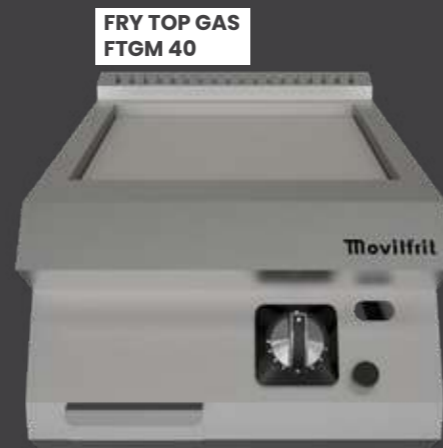

Modelo		Código	Dimensiones L x P x H (mm)	Potencia Kw	Capacidad L	Tensión V	Peso kg	Precio €
FREIDORA ELECTRICA FEM 10	NEW	606300	400x630x300	9	10	230	10	1.445
COCINA GAS 2 FUEGOS CGM 2	NEW	606320	400x630x300	10	--	--	12	867
FRY TOP GAS FTGM 40	NEW	606330	400x630x300	7	--	--	20	1.084
BARBACOA GAS BGM 40	NEW	606340	400x630x300	7	--	--	25	1.355



PLANCHAS

GRIDDLES • PLANCHAS

ELÉCTRICAS
ELECTRIC
ÉLECTRIQUES

A GAS
GAS
À GAZ



BANDEJA RECOGEDOR DE GRASA
GREASE COLLECTOR TRAY
PLATEAU COLLECTEUR DE GRAISSES

PLACA LAMINADA DE HIERRO
LAMINATED IRON PLATE
PLAQUE EN FER LAMINÉ

PEM 60



PATAS ANTIDESLIZANTES
NON-SLIP LEGS
PIEDS ANTIDÉRAPANTS

INTERRUPTOR GENERAL
GENERAL SWITCH
INTERRUPTEUR GÉNÉRAL

CONSTRUIDA EN ACERO INOXIDABLE AISI304
BUILT IN AISI304 STAINLESS STEEL
CONSTRUIT EN ACIER INOXYDABLE AISI304

TERMOSTATO TRABAJO REGULABLE
ADJUSTABLE WORKING THERMOSTAT
THERMOSTAT DE TRAVAIL RÉGLABLE

PLANCHAS ELÉCTRICAS ELECTRIC GRIDDLES PLANCHAS ÉLECTRIQUES



PEM 40



PEM 60



Modelo	Código	Dimensiones L x P x H (mm)	Potencia W	Temperatura °C	Tensión V	Medidas Placa L x P x H (mm)	Peso kg	Precio €
PEM 40	NEW 203023	400x500x200	2,5	80/300	230	380X480	15	300
PEM 60	NEW 203024	600x500x200	5	80/300	230	580X480	22	406

BANDEJA RECOGEDOR DE GRASA
GREASE COLLECTOR TRAY
PLATEAU COLLECTEUR DE GRAISSES

PLACA LAMINADA DE HIERRO
LAMINATED IRON PLATE
PLAQUE EN FER LAMINÉ

PGM 60



PATAS ANTIDESLIZANTES
NON-SLIP LEGS
PIEDS ANTIDÉRAPANTS

PIEZO ELÉCTRICO
PIEZO ELECTRIC
PIEZO ÉLECTRIQUE

CONSTRUIDA EN ACERO INOXIDABLE AISI304
BUILT IN AISI304 STAINLESS STEEL
CONSTRUIT EN ACIER INOXYDABLE AISI304

REGULACIÓN VÁLVULA GAS
GAS VALVE ADJUSTMENT
RÉGLAGE DE LA SOUPAPE À GAZ

PLANCHA GAS ECONÓMICAS ECONOMIC GAS GRIDDLES PLANCHA GAZ ÉCONOMIQUE

PGM 40



PGM 80



Modelo	Código	Dimensiones L x P x H (mm)	Potencia		Válvulas	Medidas Placa L x P x H (mm)	Peso kg	Precio €
			Kw	Kcal/h				
PGM 40	NEW 203047	400X500X200	3	5040	1	380X480	12	295
PGM 60	NEW 203048	600X500X200	6	10080	2	580X480	23	398
PGM 80	NEW 203049	800X500X200	6	10080	2	780X480	34	533



PGR 45



PGR 85



Modelo	Código	Dimensiones L x P x H (mm)	Potencia		Válvulas	Medidas Placa L x P x H (mm)	Peso kg	Precio €
			Kw	Kcal/h				
PGR 45	203053	465X430X260	4,5	4950	1	444X395	15	800
PGR 65	203054	665X430X260	7	7701	2	644X395	27	811
PGR 85	203055	865X430X260	9	9901	2	844X395	37	1.063

BANDEJA RECOGEDOR DE GRASA
GREASE COLLECTOR TRAY
PLATEAU COLLECTEUR DE GRAISSES

PLACA CROMADA
CHROME PLATE
PLAQUE CHROME

PGC 65

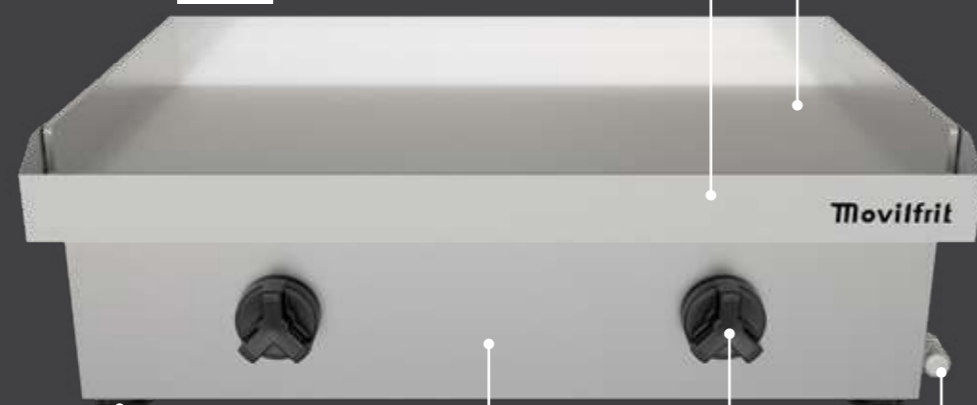

PATAS ANTIDESLIZANTES
NON-SLIP LEGS
PIEDS ANTIDÉRAPANTS

ENTRADA DE GAS
GAS INPUT
ENTRÉE DE GAZ

CONSTRUIDA EN ACERO INOXIDABLE AISI304
BUILT IN AISI304 STAINLESS STEEL
CONSTRUIT EN ACIER INOXYDABLE AISI304

REGULACIÓN VÁLVULA GAS
GAS VALVE ADJUSTMENT
RÉGLAGE DE LA SOUPE À GAZ

PGC 45



PGC 85



Modelo	Código	Dimensiones L x P x H (mm)	Potencia		Válvulas	Medidas Placa L x P x H (mm)	Peso kg	Precio €
			Kw	Kcal/h				
PGC 45	203062	400X430X220	4,5	4950	1	444X395	19	1.228
PGC 65	203063	600X430X220	7	7701	2	644X395	30	1.422
PGC 85	203064	800X430X220	9	9901	2	844X395	41	1.731



COCCINAS

KITCHENS · CUISINES

A GAS
GAS
À GAZ

FOGÓN EXTRAÍBLE PARA FACILITAR SU LIMPIEZA Y MANTENIMIENTO
REMOVABLE FIREPLACE TO EASILY CLEAN AND MAINTENANCE
FOYER AMOVIBLE POUR UN NETTOYAGE ET UNE MAINTENANCE FACILES



PARRILLA DESMONTABLE
REMOVABLE GRILL
GRIL AMOVIBLE

CONSTRUIDA EN ACERO INOXIDABLE AISI304
BUILT IN AISI304 STAINLESS STEEL
CONSTRUIT EN ACIER INOXYDABLE AISI304

REGULACIÓN VÁLVULA GAS
GAS VALVE ADJUSTMENT
RÉGLAGE DE LA SOUPE À GAZ

COCINAS A GAS GAS KITCHENS CUISINES À GAZ

ECOM 3 FUEGOS



ECOM 1 FUEGO



ECOM 4 FUEGOS



Modelo	Código	Dimensiones L x P x H (mm)	Potencia Kw	Kcal/h	Válvulas	Peso kg	Precio €
ECOM 1 FUEGO NEW	203098	450X490X200	6	10080	1	2	436
ECOM 2 FUEGOS NEW	203099	800X490X200	12	20160	2	24	794
ECOM 3 FUEGOS NEW	203100	1200X490X200	18	30240	3	36	1.185
ECOM 4 FUEGOS NEW	203101	800X840X200	24	40320	4	50	1.350



BARBACOOAS

BARBACUE • BARBECUE

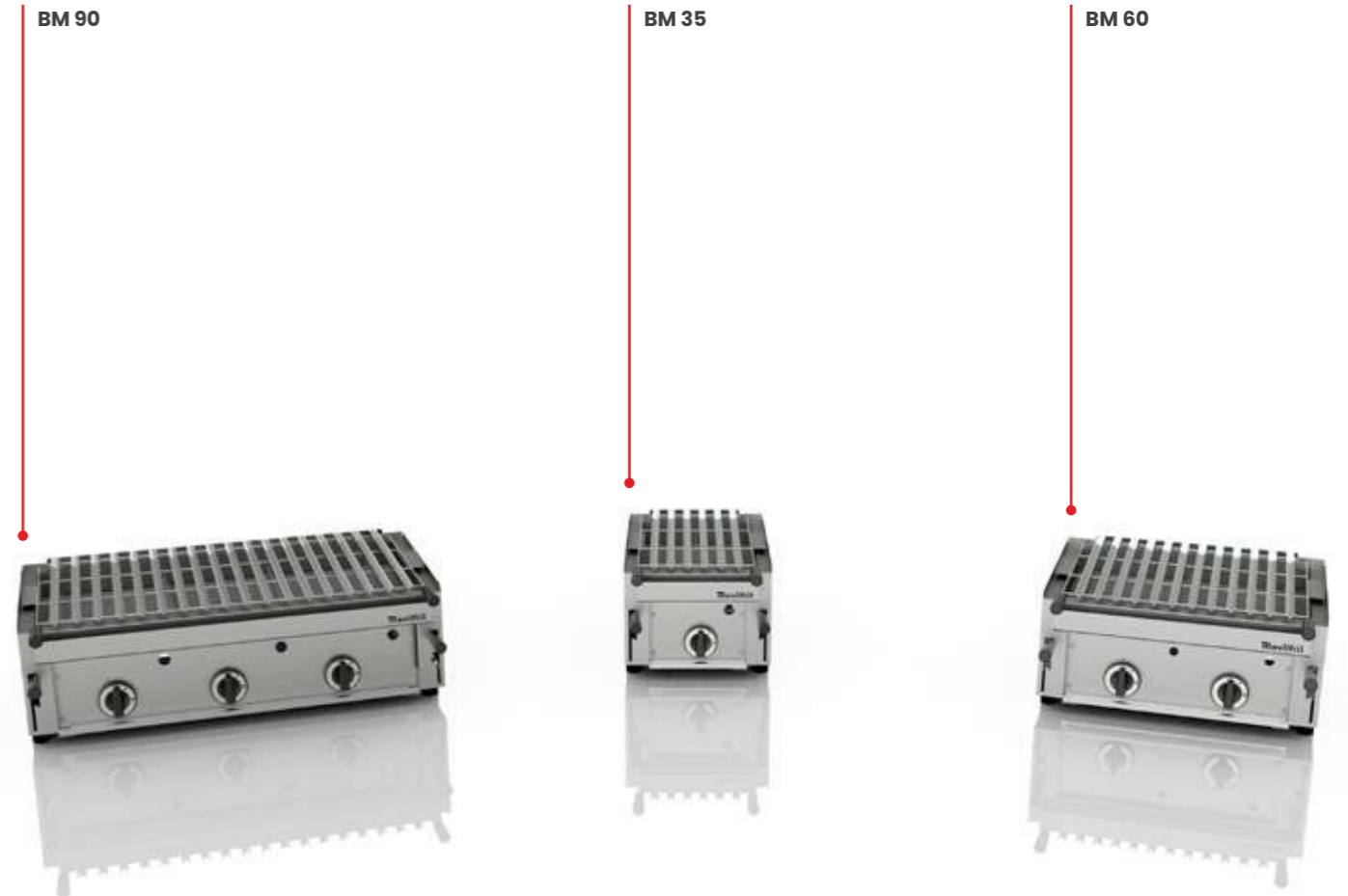

Modelo	Código	Dimensiones L x P x H (mm)	Potencia		Válvulas	Peso kg	Precio €
			Kw	Kcal/h			
BM 35	NEW 203095	370x600x260	6,8	11424	1	25	768
BM 60	NEW 203096	600x600x260	13,6	22848	2	39	1.174
BM 90	NEW 203097	900x600x260	20,4	34272	3	53	1.656



MAQUINARIA AUXILIAR

SMALL APPLIACNE • PETIT APPAREIL

TOSTADORES
TOASTERS
GRILLE-PAIN

MICROONDAS
MICROWAVES
FOURS MICRO-ONDES

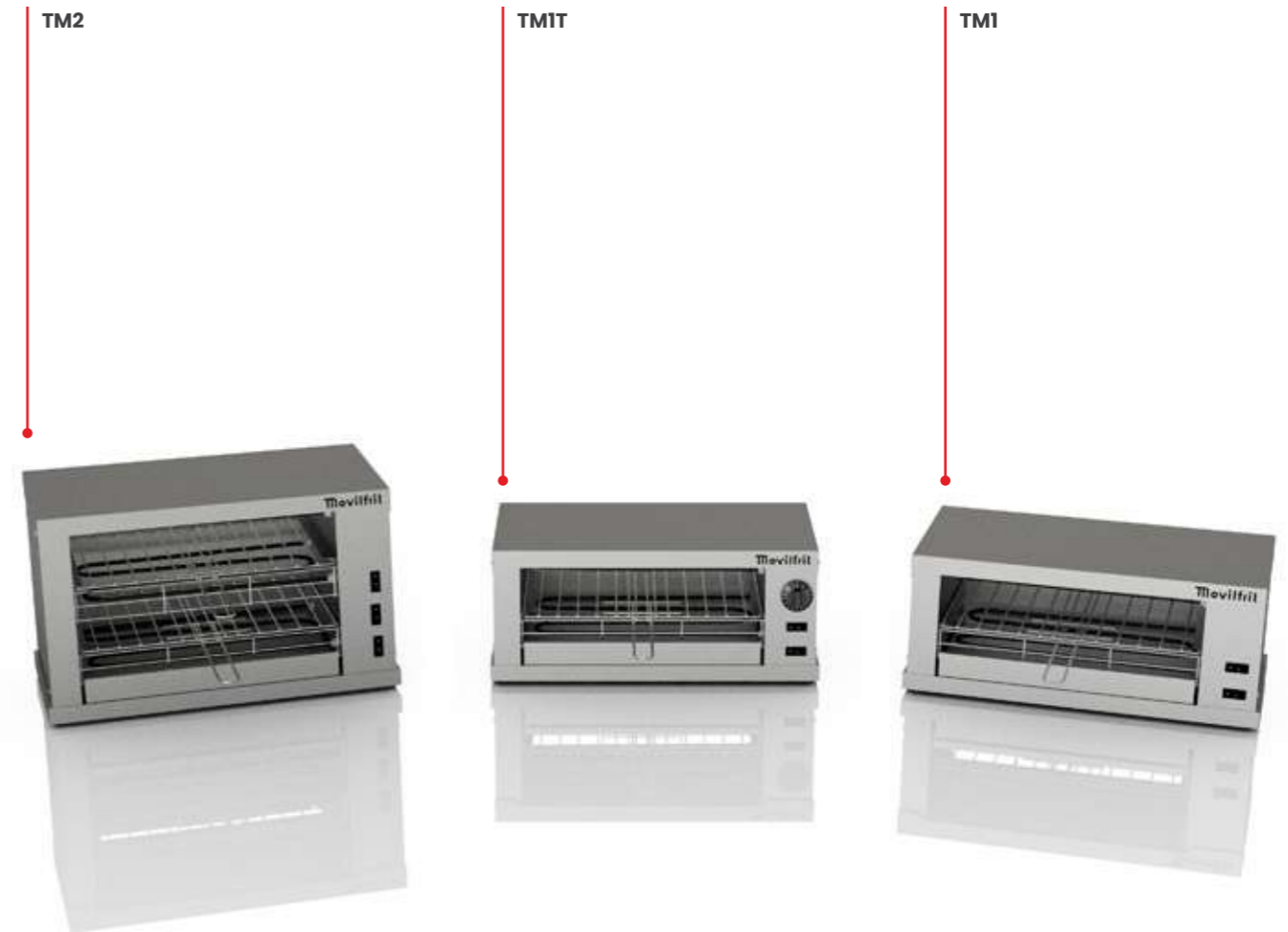

Modelo		Código	Dimensiones L x P x H (mm)	Potencia Kw	Temporizador min	Prof.Interior mm	Tensión V	Precio €
TM1	NEW	440030	535X270X280	2,4	NO	230	7	241
TM1T	NEW	440031	535X270X280	2,4	SI	230	7	256
TM2	NEW	440032	535X270X370	3,6	NO	230	9	295
TM2T	NEW	440033	535X270X370	3,6	SI	230	9	310



CONSTRUIDA EN ACERO INOXIDABLE AISI304
BUILT IN AISI304 STAINLESS STEEL
CONSTRUIT EN ACIER INOXYDABLE AISI304

INTERRUPTOR GENERAL
GENERAL SWITCH
INTERRUPTEUR GÉNÉRAL

INTERRUPTORES RESISTENCIAS
RESISTORS SWITCHES
COMMUTATEURS DE RÉSISTANCES

REGULADOR VELOCIDAD DE LA CINTA
BELT SPEED REGULATOR
RÉGULATEUR DE VITESSE DE COURROIE

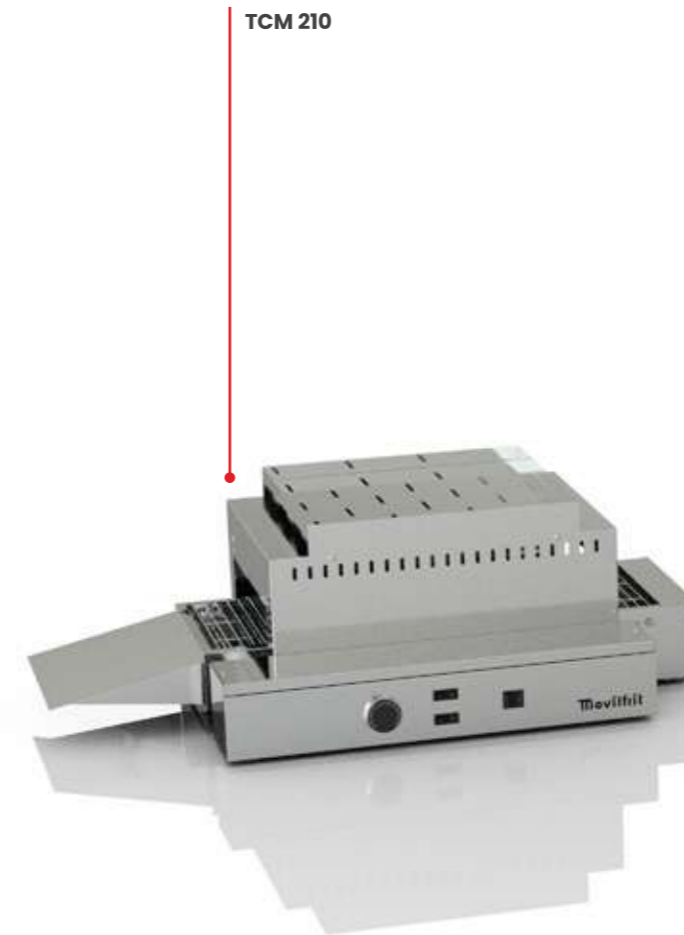

Modelo	Código	Dimensiones L x P x H (mm)	Potencia Kw	Temporizador min	Prof.Interior mm	Tensión V	Precio €
TCM 210	440034	885x450x320	3	210x75(h)	25	230	1.535
TCM 375	440035	885x615x320	4	375x75(h)	30	230	1.686

900 INOX



900 INOX DIGITAL



PANTALLA DIGITAL
DIGITAL SCREEN
ÉCRAN NUMÉRIQUE

REGULADOR DE TIEMPO Y MENÚ
MENU AND TIME REGULATOR
RÉGULATEUR DE TEMPS ET MENU

900 INOX MANUAL



REGULADOR DE POTENCIA
POWER REGULATOR
RÉGULATEUR DE PUISSANCE

REGULADOR DE TIEMPO
TIME REGULATOR
RÉGULATEUR DE TEMPS

GRILL INCORPORADO
GRILL INCLUDED
GRIL INCORPORÉ

MICROONDAS ECONOMICO
MICROWAVE ECONOMIC OVEN
FOUR MICRO-ONDES ÉCONOMIQUE



900 INOX DIGITAL



900 INOX MANUAL



Modelo	Código	Dimensiones exteriores L x P x H (mm)	Dimensiones interiores L x P x H (mm)	Capacidad L	Potencia Kw	Grill Kw	Tensión V	Peso Kg	Precio €
900 INOX MANUAL	402026	483X398X281	315x360x195	23	1+0,9	0,9	230	15,5	264
900 INOX DIGITAL	402025	483X398X281	315x360x195	23	0,9	---	230	15,5	278



DOMÈSTICO

DOMESTIC • DOMESTIQUE

FREIDORAS
FRYERS
FRITEUSES

PLANCHAS
GRIDDLES
PLANCHAS

LUX 5



LOGOTIPO
PERSONALIZABLE

AGUA Y
ACEITE

CABEZAL
MÓVIL

0°C / 200°C

ELÉCTRICA
230 V

VISOR AGUA
Y ACEITE

VACIADO
MÁQUINA

CABEZAL ELÉCTRICO EXTRAÍBLE (LIMPIEZA FÁCIL)
REMOVABLE ELECTRIC HEAD (EASY CLEANING)
TÊTE ÉLECTRIQUE AMOVIBLE (NETTOYAGE FACILE)

TERMOSTATO TRABAJO REGULABLE
ADJUSTABLE WORKING THERMOSTAT
THERMOSTAT DE TRAVAIL RÉGLABLE



PATAS ANTIDESLIZANTES
NON-SLIP LEGS
PIEDS ANTIDÉRAPANTS

GRIFO PARA EVACUAR ACEITE
EVACUATE OIL TAP
ROBINET POUR ÉVACUER L'HUILE

SISTEMA DE ELEVACIÓN
ELEVATION SYSTEM
SYSTÈME D'ÉLÉVATION

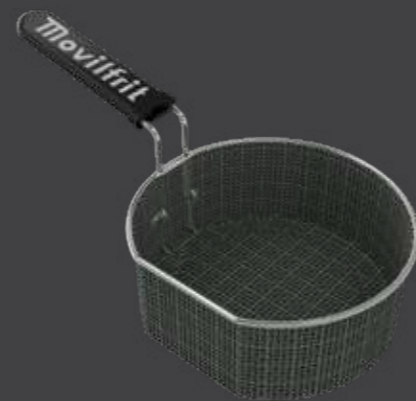

DISPONIBLE CON CESTA DE RESIDUOS
AVAILABLE WITH WASTE BASKET
DISPONIBLE AVEC PANIER À DÉCHETS

CESTA REFORZADA EN MALLA Y VARILLA DE ACERO INOX
REINFORCED STAINLESS STEEL BASKET IN MESH AND ROD
PANIER REINFORCÉ EN MAILLE ET TIGE EN ACIER INOXYDABLE

*SOLO INCLUIDO EN EL MODELO LUX5 + FILTRO

FREIDORA AGUA-ACEITE LUX 5
WATER AND OIL FRYER LUX 5
FRITEUSE EAU-HUILE LUX 5



Modelo	Código	Dimensiones L x P x H (mm)	Potencia Kw	Voltaje V	Temp. °C	Capacidad			Cesta L x P x H (mm)	Raciones 200g	Peso kg	Precio €
						Agua (L)	Aceite (L)	Total (L)				
LUX 5	117054	320X270X280	2	230	200	1	4	5	RED.200X80	25	5,5	306
LUX 5 + FILTRO	117055	320X270X280	2	230	200	1	4	5	RED.200X80	25	5,5	350

PE 500 LUX

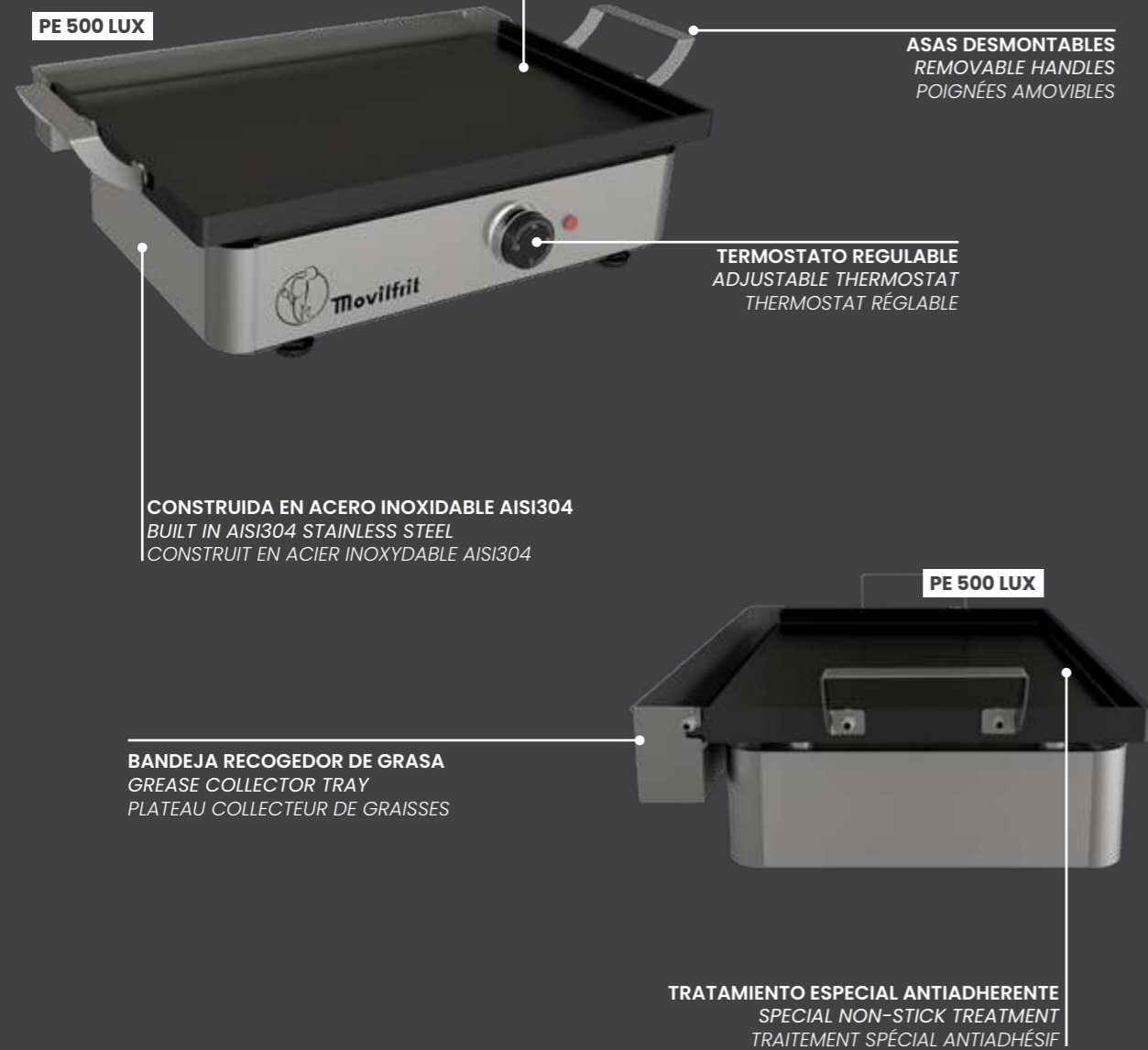

PLANCHA ELECTRICA PE 500 LUX
ELECTRIC GRILL PE 500 LUX
PLANCHA ÉLECTRIQUE PE 500 LUX



Modelo	Código	Dimensiones L x P x H (mm)	Potencia Kw	Voltaje V	Temperatura °C	Placa L x P x H (mm)	Peso kg	Precio €
PE 500 LUX	203030	550X315X150	2,5	230	300	450x300	11	275



RECAMBIOS

SPARE PARTS • PIÈCES DÉTACHÉES

FREIDORAS · FRYERS · FRITEUSES

905035	BRIDA GRIFO MOD.5	2,83 €
907029	CABEZAL DC-6	299,50 €
907030	CABEZAL DC-8/10	310,80 €
907020	CABEZAL DCF-10	310,80 €
907024	CABEZAL F10	180,63 €
907021	CABEZAL FA4	175,25 €
907022	CABEZAL FA6	180,28 €
907023	CABEZAL FA-8/9/10 (Anterior 2016)	210,32 €
907025	CABEZAL FA-8/9/10 (Versión 2016)	170,95 €
907008	CABEZAL FAR10	954,91 €
907026	CABEZAL FAR17/12	1.170,12 €
907004	CABEZAL FAR25	1.310,17 €
907877	CABEZAL MOD.10 400V	635,82 €
907878	CABEZAL MOD.10/12/17 230V	610,05 €
907879	CABEZAL MOD.17/12 400V	705,62 €
907881	CABEZAL MOD.25	920,87 €
907882	CABEZAL MOD.35	1.425,47 €
907002	CABEZAL MOD.5	131,27 €
907874	CABEZAL MOD.FA-10 MAX 230V	629,50 €
907872	CABEZAL MOD.FA-10 MAX 230V DERECHO	629,50 €
907875	CABEZAL MOD.FA-10 MAX 400V	679,81 €
907873	CABEZAL MOD.FA-10 MAX 400V DERECHO	679,81 €
907868	CABEZAL MOD.PRO MAX 8 230V	629,50 €
907869	CABEZAL MOD.PRO MAX 8 400V	664,75 €
907870	CABEZAL MOD.PRO MAX 10 230 V	629,50 €
907871	CABEZAL MOD.PRO MAX 10 400V	679,81 €
901055	CABLE CLAVIJA	10,80 €
908054	CADENA MOD.25	26,12 €
908056	CADENA MOD.35	29,12 €
901060	CAPUCHON FASTON	0,20 €
907044	CESTA FA-8/9/10	103,42 €
907045	CESTA REFORZADA MOD.8/10	111,77 €
907038	CESTA MOD.10	114,41 €
907041	CESTA MOD.12/17	149,74 €
907052	CESTA MOD.12/2-17/2	141,53 €
907042	CESTA MOD.25	197,84 €
907033	CESTA MOD.25/2	143,20 €
907043	CESTA MOD.35	290,56 €
907034	CESTA MOD.35/2	254,76 €

FREIDORAS · FRYERS · FRITEUSES

907048	CESTA MOD.4	95,31 €
907039	CESTA REFORZADA MOD.4	100,15 €
907035	CESTA MOD.5	60,61 €
907047	CESTA MOD.6	99,56 €
907037	CESTA REFORZADA MOD.6	102,69 €
901099	CESTA RESIDUOS MOD.5	29,70 €
905071	COJINETE EJE ELEVACION MOD.10/12/17	6,22 €
905058	COJINETE EJE ELEVACION MOD.5	4,67 €
907155	CONJUNTO ELEVACION MOD.10/12/17	88,23 €
907104	CONJUNTO ELEVACION MOD.25/35	183,46 €
901154	CONTACTOR AF09-30-01-13 3P 230V.4KW	58,72 €
901155	CONTACTOR AF09-30-01-14 3P 400V.4KW	58,72 €
901156	CONTACTOR AF09-30-10-13 3P 230V.4KW	58,72 €
901157	CONTACTOR AF09-30-10-14 3P 400V.4KW	58,72 €
901161	CONTACTOR AF26-30-00-14 3P 400V IIKW+AUXILIAR	140,12 €
905064	CREMALLERA MOD.F10	31,17 €
905055	CREMALLERA MOD.FH10/12/17	17,05 €
905134	EJE ELEVACION MOD.10/12/17	7,36 €
908104	EMBRAGUE NYLON MOD.10/12/17	3,12 €
908103	EMBRAGUE NYLON MOD.5	3,12 €
908101	ESCUDO GOMA POMO ELEVACION MOD.25/35	8,51 €
901281	ESCUDO TERMOSTATO	4,80 €
901100	FILTRO RESIDUOS MOD. FA8/10	40,10 €
901101	FILTRO RESIDUOS MOD. FA6	35,02 €
901102	FILTRO RESIDUOS MOD.10	40,10 €
901103	FILTRO RESIDUOS MOD.12/17	45,28 €
901104	FILTRO RESIDUOS MOD.25	50,30 €
901105	FILTRO RESIDUOS MOD.35	55,63 €
907088	GRIFO COMPLETO F-5	70,59 €
907089	GRIFO COMPLETO 3/4	40,43 €
901372	GRIFO FREIDORA 1 1/4"	41,35 €
901373	GRIFO FREIDORA 3/4" PALANCA	17,57 €
901371	GRIFO FREIDORA 3/4" PALOMILLA	18,82 €
901374	GRIFO MOD.FH-10	33,78 €
901405	INTERRUPTOR GENERAL 32 AMPERIOS	149,74 €
901404	INTERRUPTOR GENERAL 40 AMPERIOS	170,25 €
908257	JUNTA CRISTAL NIVEL 10/17/25/35	1,75 €
908255	JUNTA GRIFO 3/4" FREIDORA	1,23 €
908251	JUNTA GRIFO MOD.5	2,04 €

FREIDORAS · FRYERS · FRITEUSES

908250	JUNTA GRIFO MOD.FH-10	2,28 €
908253	JUNTA NIVEL MOD.10,12/17/25/35	1,86 €
908252	JUNTA NIVEL MOD.5	1,75 €
905225	JUNTA TORNILLO GRIFO MOD.5	0,22 €
905226	JUNTA TORNILLO NIVEL MOD.5/6	0,22 €
901510	MANDO INTERRUPTOR 40 AMPERIOS	18,34 €
907087	MANGO CESTA MOD.12/17/25	24,28 €
907086	MANGO CESTA MOD.4/6/8/10	23,99 €
907081	MANGO CESTA MOD.5	10,28 €
901521	MANGO GRIFO MOD.5	13,60 €
901504	MANOPLA TERMOSTATO FREIDORA	4,91 €
901162	MINICONTACTOR 1 NA 230	44,19 €
901163	MINICONTACTOR 1 NC 230	44,19 €
907032	NIVEL COMPLETO MOD.10/12/17	55,63 €
907103	NIVEL COMPLETO MOD.25/35	177,70 €
907006	NIVEL COMPLETO MOD.5/6	52,36 €
901622	PASACABLE CABEZALES FH	8,81 €
901620	PASACABLE MOD.5/6/8/10	1,86 €
905359	PASADOR INOX 2,5X8 MANGO GRIFO	1,11 €
905842	PATA FREIDORA	12,14 €
901580	PILOTO REDONDO AMBAR 400V.	3,58 €
901582	PILOTO REDONDO INCOLORO 400V.	3,58 €
901581	PILOTO REDONDO ROJO 400V.	3,58 €
901583	PILOTO REDONDO ROJO MOD.5	3,54 €
907080	PLASTICO MANGO CESTA FREIDORA	5,93 €
907085	PLASTICO MANGO CESTA FREIDORA LUX	9,42 €
907007	POMO ELEVACION COMPLETO MOD.5/6	17,82 €
908367	POMO ELEVACION PLASTICO 25/35	6,74 €
907105	POMO MANDO ELEVACION COMPLETO MOD.25/35	70,21 €
907116	POMO MANDO ELEVACION MOD.10/12/17 COMPLETO	71,52 €
908020	POMO TAPA FREIDORA	4,95 €
908370	PRENSA ESTOPA CABEZAL FREIDORA	2,28 €
901621	PRENSA ESTOPA TERMOSTATO MOD.25/35	4,69 €
905408	RACORD 3/4" GRIFO FA-8/10	11,92 €
901688	RESISTENCIA MOD. FAR 10 10000W	279,66 €
901686	RESISTENCIA MOD. FAR 17/12 17000W	759,29 €
901687	RESISTENCIA MOD. FAR 25 25000W	891,34 €
901684	RESISTENCIA MOD.10 6000W 400V	216,94 €
901677	RESISTENCIA MOD.10/12/17 6000W 230V	133,70 €

FREIDORAS · FRYERS · FRITEUSES

901678	RESISTENCIA MOD.17/12 7000W 400V	183,93 €
901680	RESISTENCIA MOD.25 15000W	415,02 €
901681	RESISTENCIA MOD.35 25000W	685,98 €
901685	RESISTENCIA MOD.4 2000W	66,96 €
901701	RESISTENCIA MOD.5 2000W	43,86 €
901689	RESISTENCIA MOD.6 2900W NUEVO	47,40 €
901691	RESISTENCIA MOD.8/FA10 4000W	68,52 €
901690	RESISTENCIA MOD.F-10 4000W	68,52 €
901705	RESISTENCIA MOD.FA-8/10 6000W MAX 230V	193,60 €
901706	RESISTENCIA MOD.FA-8/10 6000W MAX 400V	285,37 €
901707	RESISTENCIA MOD.FA-10 9000W MAX 400V	330,13 €
907018	RODILLO RESISTENCIA COMPLETO MOD.25/35	16,01 €
905429	SOPORTE CABEZAL MOD.4/6/9	7,87 €
905420	SOPORTE FIJACION CABEZAL FREIDORA	18,53 €
905451	TAPA CAJA CABEZAL MOD.5	6,19 €
907011	TAPA MOD.12/17	31,44 €
907012	TAPA MOD.25	53,51 €
907013	TAPA MOD.35	73,47 €
905116	TAPA MOD.5	8,37 €
907010	TAPA MOD.F/FAP-10	24,39 €
907009	TAPA MOD.FA-6/8/10	24,39 €
907110	TERMOSTATO FREIDORA E20	30,25 €
901771	TERMOSTATO SEGURIDAD 5	16,60 €
901770	TERMOSTATO SEGURIDAD FREIDORA	18,49 €
905361	ZOCALO MOD.5	9,54 €

VITRINAS · DISPLAY CASES · VITRINES

916810	BANDEJA GASTRONORM 1/3	21,06 €
918381	CRISTAL CALENTADOR IRON 4	237,31 €
918379	CRISTAL CALENTADOR IRON 6	245,97 €
916942	CRISTAL ESTANTE CUB 4 2P	162,23 €
916939	CRISTAL ESTANTE CUB 6 2P	157,32 €
916967	CRISTAL ESTANTE CUB 8 2P	185,40 €
916901	CRISTAL ESTANTE IRON 4 2P	91,71 €
914002	CRISTAL ESTANTE IRON 6 2P	115,87 €
914003	CRISTAL ESTANTE IRON 8 2P	139,85 €
1224110	CRISTAL EXPOSITOR 1P PLANO SUP/FRON/ESTAN	49,14 €
1224140	CRISTAL EXPOSITOR 2P PLANO FRONTAL	86,35 €
1224180	CRISTAL EXPOSITOR CURVO 1 PISO	136,96 €
1224190	CRISTAL EXPOSITOR CURVO 2 PISOS	143,42 €
919040	CRISTAL EXPOSITOR IRON BLANCO 4	289,73 €
919042	CRISTAL EXPOSITOR IRON BLANCO 4 2P	303,25 €
919044	CRISTAL EXPOSITOR IRON BLANCO 6	310,26 €
919046	CRISTAL EXPOSITOR IRON BLANCO 6 2P	325,06 €
919048	CRISTAL EXPOSITOR IRON BLANCO 8	383,16 €
919050	CRISTAL EXPOSITOR IRON BLANCO 8 2P	398,05 €
916913	CRISTAL EXPOSITOR IRON NEGRO 4	289,73 €
916914	CRISTAL EXPOSITOR IRON NEGRO 4 2P	303,25 €
916915	CRISTAL EXPOSITOR IRON NEGRO 6	310,26 €
916916	CRISTAL EXPOSITOR IRON NEGRO 6 2P	330,46 €
916917	CRISTAL EXPOSITOR IRON NEGRO 8	383,16 €
916918	CRISTAL EXPOSITOR IRON NEGRO 8 2P	398,05 €
919039	CRISTAL EXPOSITOR IRON ROJO 4	289,73 €
919041	CRISTAL EXPOSITOR IRON ROJO 4 2P	303,25 €
919043	CRISTAL EXPOSITOR IRON ROJO 6	310,26 €
919045	CRISTAL EXPOSITOR IRON ROJO 6 2P	325,06 €
919047	CRISTAL EXPOSITOR IRON ROJO 8	383,16 €
919049	CRISTAL EXPOSITOR IRON ROJO 8 2P	398,05 €
916819	CRISTAL EXPOSITOR VECI/JADE 4	223,27 €
916820	CRISTAL EXPOSITOR VECI/JADE 6	235,00 €
916821	CRISTAL EXPOSITOR VECI/JADE 8	259,14 €
916948	CRISTAL FRONTAL CALENTADOR CUB 4	85,83 €
916950	CRISTAL FRONTAL CALENTADOR CUB 6	122,05 €
916930	CRISTAL FRONTAL CUB 4	146,48 €
916940	CRISTAL FRONTAL CUB 4 2P	145,21 €
916932	CRISTAL FRONTAL CUB 6	171,90 €

VITRINAS · DISPLAY CASES · VITRINES

916937	CRISTAL FRONTAL CUB 6 2P	185,01 €
916934	CRISTAL FRONTAL CUB 8	162,80 €
916965	CRISTAL FRONTAL CUB 8 2P	184,49 €
916954	CRISTAL FRONTAL NEUTRA CUB 4	122,05 €
916956	CRISTAL FRONTAL NEUTRA CUB 6	146,25 €
916958	CRISTAL FRONTAL NEUTRA CUB 8	171,90 €
916826	CRISTAL MOTOR BLANCO/PLATA	101,43 €
916951	CRISTAL SUPERIOR CALENTADOR CUB 6	88,33 €
916955	CRISTAL SUPERIOR CALENTADOR CUB 4	54,60 €
916931	CRISTAL SUPERIOR CUB 4	154,83 €
916941	CRISTAL SUPERIOR CUB 4 2P	154,83 €
916933	CRISTAL SUPERIOR CUB 6	158,15 €
916938	CRISTAL SUPERIOR CUB 6 2P	183,03 €
916935	CRISTAL SUPERIOR CUB 8	190,43 €
916966	CRISTAL SUPERIOR CUB 8 2P	190,20 €
916949	CRISTAL SUPERIOR NEUTRA CUB 4	57,68 €
916957	CRISTAL SUPERIOR NEUTRA CUB 6	73,34 €
916959	CRISTAL SUPERIOR NEUTRA CUB 8	162,19 €
918554	FUENTE DE ALIMENTACION LED 30W	24,37 €
916840	INTERRUPTOR RECTANGULAR	6,15 €
916785	JUEGO PUERTAS CUB/CALENT/NEUTRA 6	37,91 €
916786	JUEGO PUERTAS CUB/NEUTRA 8	44,93 €
916784	JUEGO PUERTAS CUB/CALENT/NEUTRA 4	37,53 €
916792	JUEGO PUERTAS EXPOSITOR 1 PISO	35,23 €
916793	JUEGO PUERTAS EXPOSITOR 2 PISOS	55,70 €
916842	JUEGO PUERTAS IRON/IRON 2P/CALENT/CUB2P 4	28,11 €
916851	JUEGO PUERTAS IRON/IRON2P/CALENT/CUB2P 6	34,37 €
916879	JUEGO PUERTAS IRON/IRON2P/CALENT/CUB2P 8	37,78 €
916794	JUEGO PUERTAS IRON 4 2P/CUB 4 2P (v.2022)	56,17 €
916795	JUEGO PUERTAS IRON 6 2P/CUB 6 2P (v.2022)	60,19 €
916796	JUEGO PUERTAS IRON 8 2P/CUB 8 2P (v.2022)	65,60 €
916789	JUEGO PUERTAS VECI/JADE 4	37,77 €
916790	JUEGO PUERTAS VECI/JADE 6	38,17 €
916791	JUEGO PUERTAS VECI/JADE 8	31,25 €
916872	JUEGO SOPORTE VITRINA	111,21 €
905415	KIT DESAGÜE VITRINA	65,00 €
918395	LATERAL DERECHO CALENTADOR IRON 1P	78,42 €
1224170	LATERAL EXPOSITOR 1 PISO CURVO	31,48 €
1224120	LATERAL EXPOSITOR 1 PISO PLANO	32,99 €

VITRINAS · DISPLAY CASES · VITRINES

1224160	LATERAL EXPOSITOR 2 PISOS CURVO	46,43 €
1224150	LATERAL EXPOSITOR 2 PISOS PLANO	45,60 €
918370	LATERAL RANURADO CUB 1P	63,16 €
918377	LATERAL RANURADO CUB 2P	75,52 €
918391	LATERAL RANURADO IRON 1P	71,77 €
918394	LATERAL RANURADO IRON 2P	85,17 €
918371	LATERAL TRANSPARENTE CUB 1P	72,43 €
918378	LATERAL TRANSPARENTE CUB 2P	83,07 €
918390	LATERAL TRANSPARENTE IRON 1P	71,83 €
918393	LATERAL TRANSPARENTE IRON 2P	85,17 €
918489	MOTOR VENTILADOR 10W CON SOPORTE	35,97 €
918361	PARRILLA CUBA PLANA	36,00 €
14331150	SOPORTE ESTANTE DERECHO	2,30 €
914001	SOPORTE ESTANTE IRON/CUB 2P	1,80 €
14331160	SOPORTE ESTANTE IZQUIERDO	2,30 €
918504	TERMOSTATO VITRINA CALENTADOR	18,05 €
916986	TERMOSTATO VITRINA IRON/CUB	78,29 €
918551	TIRA LED 4	38,97 €
918552	TIRA LED 6	49,95 €
918553	TIRA LED 8	61,94 €
918543	TIRA LED REMOTA/CALIENTE 4	39,95 €
918544	TIRA LED REMOTA/CALIENTE 6	51,94 €
918545	TIRA LED REMOTA/CALIENTE 8	63,94 €
14340130	TOPE GOMA PIE	2,47 €

PLANCHAS & BARBACOAS

GRIDDLES & BARBECUES · PLANCHAS & BARBECUES

905434	ASA PLANCHA PE-500 LUX	14,86 €
202808	MANOPLA PLANCHA-BARBACOA	17,14 €
202809	PARRILLA ACANALADA PAVONADA B-5	119,20 €
202810	PARRILLA ACANALADA PAVONADA B-10	181,79 €
202811	PARRILLA ACANALADA PAVONADA B-15	245,86 €
202813	POMO ELEVADOR PARRILLA	22,05 €
203071	RECOGEGRASAS PG40	74,50 €
203072	RECOGEGRASAS PG60	83,45 €
203073	RECOGEGRASAS PG80	90,89 €
905435	RESISTENCIA PLANCHA PE-500 LUX	53,43 €
202814	TERMOPAR BARBACOA	16,69 €
202815	TERMOPAR PLANCHA	14,53 €
905431	TERMOSTATO PLANCHA PE-500 LUX	41,17 €
202816	VALVULA GAS PLANCHA-BARBACOA	47,98 €
202817	VALVULA GAS TERMOSTATICA PLANCHA	131,13 €

BRASA · CHARCOAL · BRAISE

202408	CRISTAL PUERTA HORNO HBR4	210,00 €
202409	CRISTAL PUERTA HORNO HBR6	250,00 €
202802	CORTAFUEGOS EXTERNO BRASA	393,00 €
202807	PALA ATIZADOR	39,00 €
202412	PARRILLA ACANALADA BM80/BM160	345,00 €
202407	PARRILLA ACANALADA HBR6	734,10 €
202806	PARRILLA BESUGUERA	45,00 €
202805	PARRILLA PESCADO	65,00 €
202413	PARRILLA TOLVA HBR4	160,00 €
202414	PARRILLA TOLVA HBR6	260,00 €
202405	PARRILLA VARILLA HBR4	337,67 €
202406	PARRILLA VARILLA HBR6	374,00 €
202804	PINZA CON GUIA	38,00 €
202821	PLANCHAS BM80/BM160	200,00 €
202803	REGULADOR TIRO EXTERNO	289,00 €
202820	TERMOMETRO HORNO BRASA 500°C	138,00 €
202801	SOMBRERO	257,00 €

CONDICIONES VENTA



PEDIDOS

Los pedidos deberán dirigirse a nuestras instalaciones centrales de INDUSTRIA 90, S.L. y MOVILFRIT S.L., deberán ser siempre por escrito vía email a pedidos@movilfritofficial.com o web en www.movilfritofficial.com, para que quede constancia tangible y se eliminen errores de transcripción de los mismos.

Una vez efectuada la expedición los pedidos no podrán anularse. Queda reservado el derecho de no admitir pedidos a aquellos clientes que hayan incumplido anteriores contratos.

PORTES

Los portes serán pagados a partir de un pedido mínimo de 450 euros, impuestos a parte.

Cuando reciban la mercancía se debe revisar su excelente estado tanto externamente como internamente. Se debe notificar cualquier desperfecto o devolver dicha mercancía directamente al transportista por cualquier anomalía encontrada. El pendiente de revisión ha quedado sin efecto y la mercancía se debe revisar en el momento de la recepción delante del chófer. De lo contrario, no podrá procesarse cualquier incidencia a posterior.

Los gastos de transporte incluyen una única entrega, en caso de no poder ser realizada, cualquier gasto adicional corre a cuenta del cliente.

CONDICIONES DE PAGO

El pago de las facturas se realizará al contado salvo que se otorgue crédito al cliente, en cuyo caso se efectuará el pago en la forma y lugar acordado.

Para pedidos inferiores a 100 € netos, el pago se realizará mediante transferencia bancaria.

Si antes o durante la cumplimentación de un pedido se produjese el incumplimiento en los pagos, se podrá demorar la entrega de la mercancía mientras el comprador no anticipe el pago de los mismos.

EMBALAJE

El embalaje estándar de INDUSTRIA 90 S.L. y MOVILFRIT S.L. está incluido en los precios, los embalajes marítimos y especiales se cargarán en factura.

PRECIOS

Los precios que figuran en la presente tarifa son Precios Venta Público en euros. No incluyen la instalación ni puesta en marcha del material.

INDUSTRIA 90, S.L. y MOVILFRIT S.L. se reserva el derecho de modificar los precios sin previo aviso. Esta tarifa anula todas las anteriores.

GARANTÍA

La garantía será la establecida según la ley vigente, cubriendo solamente los defectos de fabricación quedando excluido la mala o indebida utilización del producto por el usuario.

Las indemnizaciones, desplazamientos y mano de obra no están cubiertas por esta garantía.

INDUSTRIA 90, S.L. y MOVILFRIT S.L. se reserva el derecho de solicitar el envío de la pieza o piezas a sustituir sin cargo y a portes pagados para su comprobación.

NO GARANTÍA

Si el uso del producto no ha sido de acuerdo a las instrucciones contenidas en el manual de instrucciones.

Si el producto ha sido usado fuera de su capacidad, haya sido golpeado o cualquier problema atribuible al cliente.

Si ha sido reparado o modificado por personas no autorizadas por nuestro Servicio Técnico o distribuidor.

Si se han utilizado líquidos o productos que puedan causar daño al producto.

Si hay o ha habido una instalación incorrecta.

Utilización de piezas no originales.

DEVOLUCIONES

No se admitirán devoluciones sin previa autorización de INDUSTRIA 90, S.L. y MOVILFRIT S.L.

Todos los gastos ocasionados por la devolución de la mercancía será a cargo del cliente.

La mercancía debe ser devuelta con su embalaje original. No se aceptará mercancía sin su embalaje original o que haya sufrido cualquier uso o manipulación.

Del importe de su devolución, se deducirá en concepto de gastos de recepción, prueba o inspección, independientemente de que en cada caso se pueda hacer otra valoración.

PROPIEDAD DE LA MERCANCIA

Toda mercancía que no esté totalmente pagada es propiedad de INDUSTRIA 90, S.L. aunque permanezca en stock del comprador.

JURISDICCIÓN

En caso de litigio sólo serán competentes los tribunales de Barcelona.

INDUSTRIA 90, S.L. y MOVILFRIT S.L., SE RESERVA EL DERECHO DE EFECTUAR VARIANTES DE DISEÑO Y ACABADOS SIN PREVIO AVISO, ASÍ COMO CARACTERÍSTICAS TÉCNICAS. ESTA TARIFA ANULA Y SUSTITUYE A TODAS LAS ANTERIORES.

Diseño y maquetación:
© COLILLAS BRANDING S.L.

© INDUSTRIA 90 S.L. / MOVILFRITS.L

Este documento y todo su contenido está protegido por el Real Decreto Legislativo 1/1996, de 12 de abril, por el que se aprueba el texto refundido de la Ley de Propiedad Intelectual, regularizando, aclarando y armonizando las disposiciones legales vigentes sobre la materia y también por la Ley 29/2009, de 30 de diciembre, General de Publicidad por la que se modifica el régimen legal de la competencia desleal y de la publicidad.

Queda rigurosamente prohibida, sin autorización escrita del titular del copyright, la reproducción total o parcial de este documento por cualquier medio o procedimiento, incluidos la reprografía y el tratamiento informático y la distribución de copias totales y/o parciales de su contenido.

El uso fraudulento de cualquier mensaje, imagen, diseño y composición aquí contenidos, están protegidos por ley y serán perseguidos legalmente por el propietario de los derechos y castigados con las sanciones establecidas por las leyes españolas.

La propiedad intelectual del mismo es, única y exclusivamente, de:
© COLILLAS BRANDING S.L.

Para más información dirigirse al titular del copyright.