



*¡Cocinando
SUEÑOS!
Cooking dreams!*

1974-2023
est.

PROFESSIONAL & HOME LINE

CATÁLOGO Tarifas

CATALOGUE Price List

CATALOGUE Tarifs

KATALOG Tarife

2023

The Stamp
of Quality



GEMINIS-GE-650

14		21	
METRICO			
MÓDULO			
MÓDULO II			
MÓDULO III			

L	13	16
	21	28
	36	45
M	60	76
	100	128
	160	208
	280	360
R	480	610
	760	1000

'Para gente encantadora'
'for lovely people'

Dyane 6

Oso

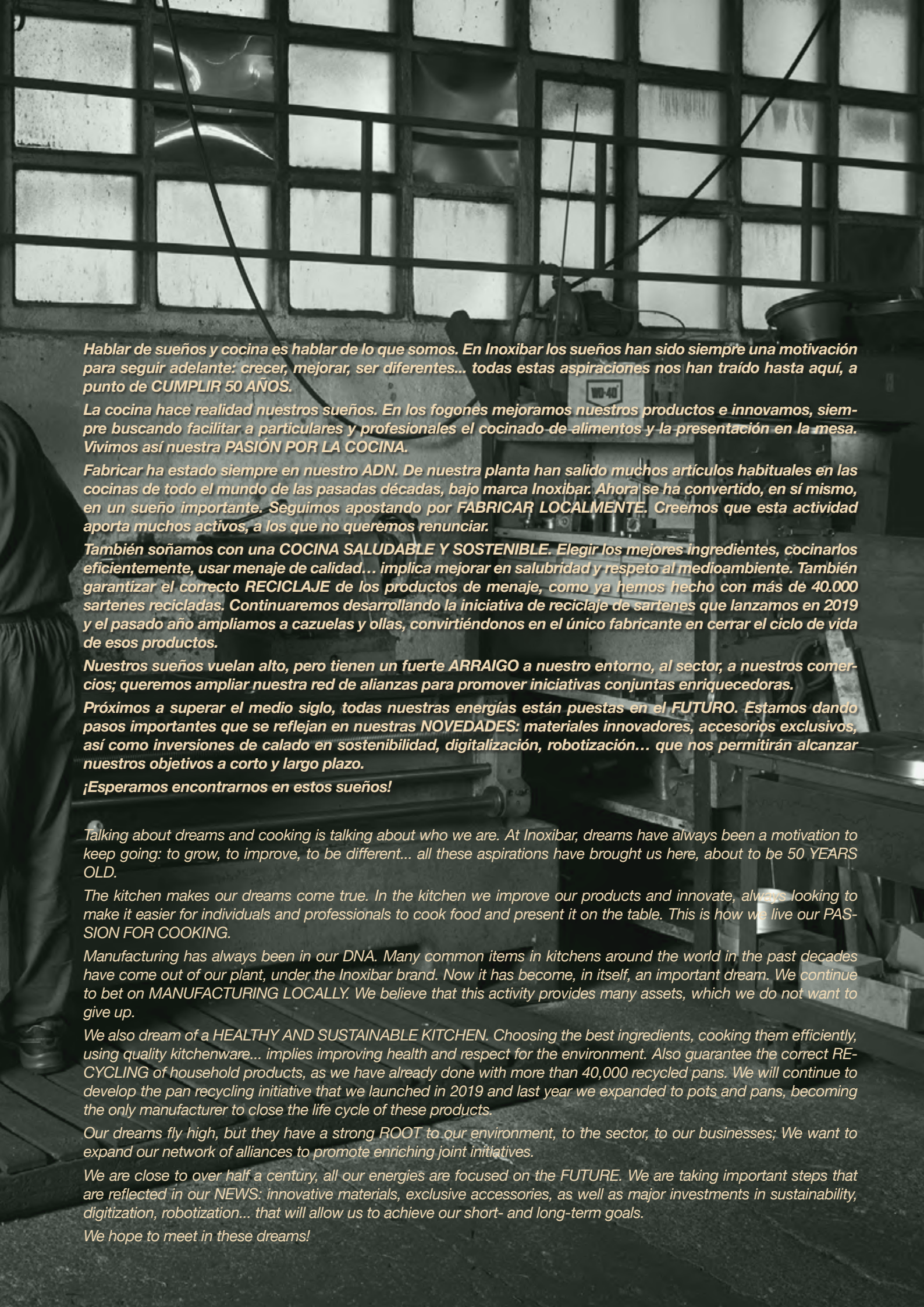

Hablar de sueños y cocina es hablar de lo que somos. En Inoxibar los sueños han sido siempre una motivación para seguir adelante: crecer, mejorar, ser diferentes... todas estas aspiraciones nos han traído hasta aquí, a punto de CUMPLIR 50 AÑOS.

La cocina hace realidad nuestros sueños. En los fogones mejoramos nuestros productos e innovamos, siempre buscando facilitar a particulares y profesionales el cocinado de alimentos y la presentación en la mesa. Vivimos así nuestra PASIÓN POR LA COCINA.

Fabricar ha estado siempre en nuestro ADN. De nuestra planta han salido muchos artículos habituales en las cocinas de todo el mundo de las pasadas décadas, bajo marca Inoxibar. Ahora se ha convertido, en sí mismo, en un sueño importante. Seguimos apostando por FABRICAR LOCALMENTE. Creemos que esta actividad aporta muchos activos, a los que no queremos renunciar.

También soñamos con una COCINA SALUDABLE Y SOSTENIBLE. Elegir los mejores ingredientes, cocinarlos eficientemente, usar menaje de calidad... implica mejorar en salubridad y respeto al medioambiente. También garantizar el correcto RECICLAJE de los productos de menaje, como ya hemos hecho con más de 40.000 sartenes recicladas. Continuaremos desarrollando la iniciativa de reciclaje de sartenes que lanzamos en 2019 y el pasado año ampliamos a cazuelas y ollas, convirtiéndonos en el único fabricante en cerrar el ciclo de vida de esos productos.

Nuestros sueños vuelan alto, pero tienen un fuerte arraigo a nuestro entorno, al sector, a nuestros comercios; queremos ampliar nuestra red de alianzas para promover iniciativas conjuntas enriquecedoras.

Próximos a superar el medio siglo, todas nuestras energías están puestas en el FUTURO. Estamos dando pasos importantes que se reflejan en nuestras NOVEDADES: materiales innovadores, accesorios exclusivos, así como inversiones de calado en sostenibilidad, digitalización, robotización... que nos permitirán alcanzar nuestros objetivos a corto y largo plazo.

¡Esperamos encontrarnos en estos sueños!

Talking about dreams and cooking is talking about who we are. At Inoxibar, dreams have always been a motivation to keep going: to grow, to improve, to be different... all these aspirations have brought us here, about to be 50 YEARS OLD.

The kitchen makes our dreams come true. In the kitchen we improve our products and innovate, always looking to make it easier for individuals and professionals to cook food and present it on the table. This is how we live our PASSION FOR COOKING.

Manufacturing has always been in our DNA. Many common items in kitchens around the world in the past decades have come out of our plant, under the Inoxibar brand. Now it has become, in itself, an important dream. We continue to bet on MANUFACTURING LOCALLY. We believe that this activity provides many assets, which we do not want to give up.

We also dream of a HEALTHY AND SUSTAINABLE KITCHEN. Choosing the best ingredients, cooking them efficiently, using quality kitchenware... implies improving health and respect for the environment. Also guarantee the correct RECYCLING of household products, as we have already done with more than 40,000 recycled pans. We will continue to develop the pan recycling initiative that we launched in 2019 and last year we expanded to pots and pans, becoming the only manufacturer to close the life cycle of these products.

Our dreams fly high, but they have a strong ROOT to our environment, to the sector, to our businesses; We want to expand our network of alliances to promote enriching joint initiatives.

We are close to over half a century, all our energies are focused on the FUTURE. We are taking important steps that are reflected in our NEWS: innovative materials, exclusive accessories, as well as major investments in sustainability, digitization, robotization... that will allow us to achieve our short- and long-term goals.

We hope to meet in these dreams!

Historia History

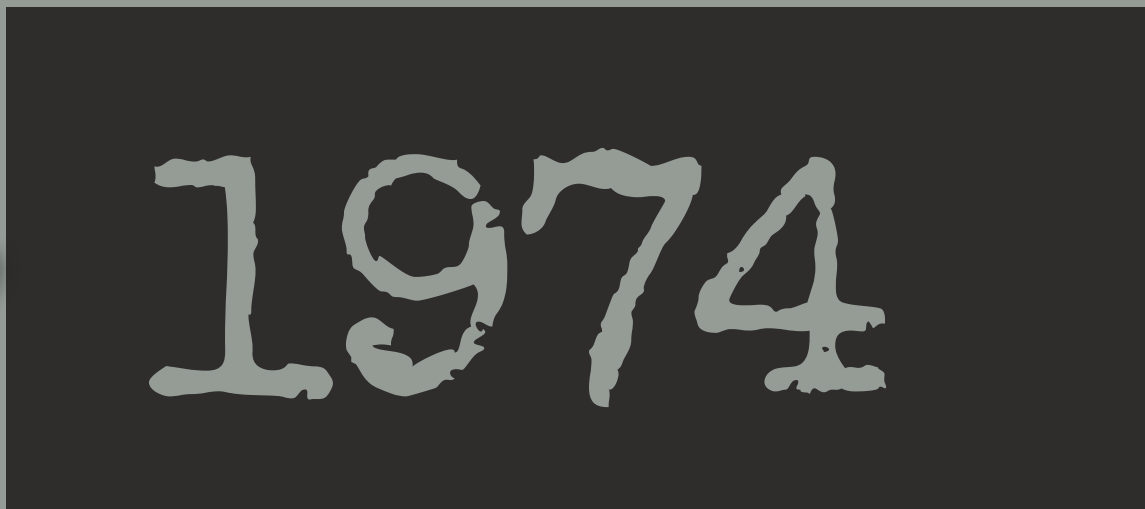



2023

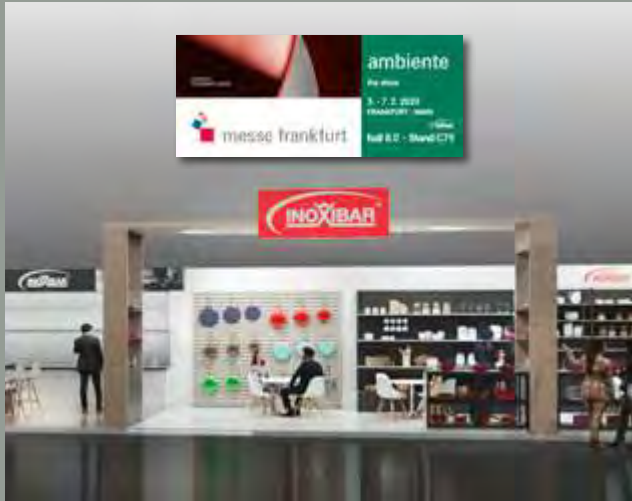

Sueños
Dreams



Proyecto
Fundawtion
@foundawtion

¡Gracias!
Thank you!
2022



#inoxibarcontigo



Espai sopem
@espaisopem



PLAN RENOVE 2022

Redes sociales
Social networks

Estanis Ochoa
@estanisochoa



Sarten y Cazo
@sarten_y_cazo

David de Jorge
@robinfood



Tpb Tech
@tpbtech



TpbTech



**Cocinando
sueños
Cooking
dreams**

2023



Fuego

Cookware
La cuisson
Kochware



Sartenes, paelleras y planchas

Fry pan, paelleras and deep fry pan
Poêle, paelleras et laques
Pfanne, paelleras und platte grill

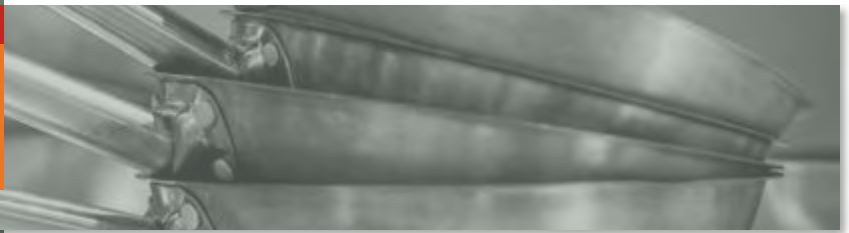

Preparación

Preparation
La preparation
Zubereitung



6

Utensilios

Tools
Le matériel de cuisine
Utensilien

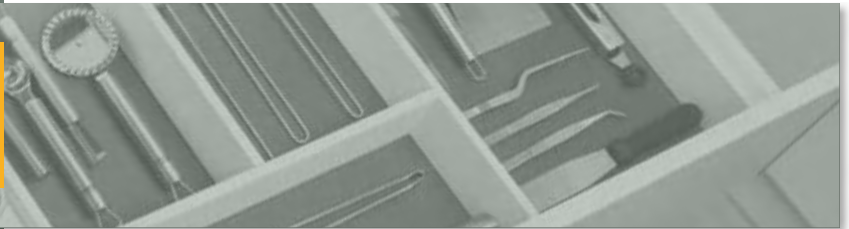

Mesa

Tableware
La table
Tisch

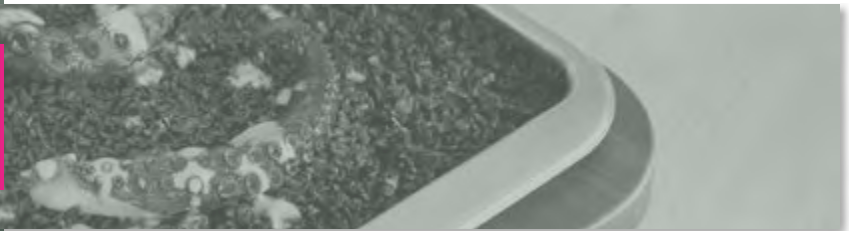

Bar

Barware
Le café bar
Bar



Outdoor

Outdoor
Outdoor
Outdoor



Índice

Index

Sommaire

Inhaltsverzeichnis

Fuego

Cookware
La cuisson
Kochware

ESP

professional line	13
star	28
expert line.....	32
G-Sola	38
ecco line	42
kamp	56
absolut line	60
Coal line	68
forêt line	72
wind	78
forma	82
D'Artagnan line	96
freidoras y cestillos	98
cocedores y cazos	102
complementos	103
tapas	104

ENG

professional line	13
star	28
expert line.....	32
G-Sola	38
ecco line	42
kamp	56
absolut line	60
Coal line	68
forêt line	72
wind	78
forma	82
D'Artagnan line	96
fryers and basket	98
saucepan	102
complements	103
lids	104

FR

professional line	13
star	28
expert line.....	32
G-Sola	38
ecco line	42
kamp	56
absolut line	60
Coal line	68
forêt line	72
wind	78
forma	82
D'Artagnan line	96
friteuses et panier	98
casserole	102
compléments	103
couvercles	104

DE

professional line	13
star	28
expert line.....	32
G-Sola	38
ecco line	42
kamp	56
absolut line	60
Coal line	68
forêt line	72
wind	78
forma	82
D'Artagnan line	96
friteuse und Frittierpf	98
stielkasserolle	102
ergänzung.	103
deckel	104

7

Sartenes, paelleras y planchas

Fry pan, paelleras and deep fry pan
Poêle, paelleras et laques
Pfanne, paelleras und platte grill

ESP

professional line	112
TRlline	116
Inoxtone line	120
Inoxtone acero line	124
PROtubeline	127
sky line	130
Eccoline	134
style line	138
style inox line	140
absolut line	144
kooper line	150
Coal line	154
forest & forêt line.....	158
Sualine	162
wind line	164
forma line.....	166

ENG

professional line	112
TRlline	116
Inoxtone line	120
Inoxtone acero line	124
PROtubeline	127
sky line	130
Eccoline	134
style line	138
style inox line	140
absolut line	144
kooper line	150
Coal line	154
forest & forêt line.....	158
Sualine	162
wind line	164
forma line.....	166

FR

professional line	112
TRlline	116
Inoxtone line	120
Inoxtone acero line	124
PROtubeline	127
sky line	130
Eccoline	134
style line	138
style inox line	140
absolut line	144
kooper line	150
Coal line	154
forest & forêt line.....	158
Sualine	162
wind line	164
forma line.....	166

DE

professional line	112
TRlline	116
Inoxtone line	120
Inoxtone acero line	124
PROtubeline	127
sky line	130
Eccoline	134
style line	138
style inox line	140
absolut line	144
kooper line	150
Coal line	154
forest & forêt line.....	158
Sualine	162
wind line	164
forma line.....	166

Preparación
Preparation
La preparation
Zubereitung

ESP

pasapurés	170
escurridores y calderos	176
medidores y graseras	178
ralladores	180
balanzas	186
horno	188
especial grill barbacoa	194
pinzas	199
repostería	200
complementos	202

ENG

food mills	170
colanders and bowls	176
measures	178
graters	180
scales and balances	186
oven	188
special grill and bbq	194
tongs	199
baking	200
complements	202

FR

Presse - purée	170
passoires et bassines	176
mesures	178
râpes	180
balances	186
plats à four	188
grill et bbq	194
pincés	199
pâtisserie	200
compléments	202

DE

passiermühlen	170
seihier und schüsseln	176
messungen	178
reiben	180
küchenwaagen	186
bräter	188
grill	194
zangen	199
Konditorei	200
küchenzubehör	202

Utensilios

Tools
Le matériel de cuisine
Utensilien

ESP

8 force line	204
especial hostelería	206
inox line	208
nylon line.....	210
nature line.....	212
silicona line.....	214
batidores	218
soportes	220
coladores	224
utensilios	230
pizza	234
barbacoa y grill	236
cocina molecular	238
pinzas	239
accesorios y peladores	244

ENG

force line	204
hotel industry	206
inox line	208
nylon line.....	210
nature line.....	212
silicone line.....	214
whisks	218
supports	220
strainers	224
gadgets line	230
pizza	234
grill & bbq	236
molecular cuisine	238
tongs	239
complements	244

FR

force line	204
hôtellerie	206
inox line	208
nylon line.....	210
nature line.....	212
silicone line.....	214
fouets	218
support	220
passoires	224
gadgets line	230
pizza	234
grill et bbq	236
cuisine moléculaire	238
pincés	239
compléments	244

DE

force line	204
Gastfreundschaft.....	206
inox line	208
nylon line.....	210
nature line.....	212
silikon line	214
rührbesen	218
hängeleiste	220
siebe	224
gadgets line	230
pizza	234
grill	236
molekularküche	238
zangen	239
küchenzubehör	244

Mesa
Tableware
La table
Tisch

ESP

catering line	246
especial presentación	248
bandejas	256
soperas	259
legumbreras	259
salvamanteles line	260
servilleteros	262
aceiteras	264

ENG

catering	246
placesetting line	248
trays	256
soup tureens	259
vegetable bowls	259
trivet line	260
napkins	262
vinegar and oil set	264

FR

catering	246
service de table	248
plats	256
soupières	259
légumiers	259
sous-plats	260
porte-serviettes	262
huile et vinaigrier	264

DE

catering	246
besondere Präsentation	248
tablets	256
Suppenterrine	259
Gemüseschale	259
topfgitter	260
servilletenhalter	262
oil und essig stütze	264

Bar
Barware
Le café bar
Bar

ESP

cafetería	266
professional line	270
cubiteras	272
cóctel	276
vino	278
servilleteros	282
bandejas	284
catering	286
pizarras	288

ENG

coffe set	266
professional line	270
ice bucket	272
cocktail	276
wine	278
napkins	282
trays	284
catering	286
blackboards	288

FR

cafétéria	266
professional line	270
seau a glace	272
cocktail	276
cave	278
port-serviettes	282
plats	284
catering	286
tableau	288

DE

kaffe	266
professional line	270
Eiswürfelbehälter	272
cocktail	276
keller	278
serviettenhalter	282
tablets	284
catering	286
Schiefertafel	288

Outdoor
Outdoor
Outdoor
Outdoor

ESP

Thermo Drink line	292
Termos Joy line	294
Thermo Can line	296
Outdoor line ..	304
Camping	308

ENG

Thermo Drink line	292
Termos Joy line	294
Thermo Can line	296
Outdoor line ..	304
Camping	308

FR

Thermo Drink line	292
Termos Joy line	294
Thermo Can line	296
Outdoor line ..	304
Camping	308

DE

Thermo Drink line	292
Termos Joy line	294
Thermo Can line	296
Outdoor line ..	304
Camping	308

Cocinando sueños

Cooking dreams
Cuisson des rêves
Kochträume

pág. 315
page 315



Merchandising	310
Merchandising	310
Merchandising	310
Merchandising	310

Lista de productos y referencias	325
List of products and references	325
Liste des produits et références	325
Aufstellung der Produkte und Artikelnummern	325

Repuestos	341
Spare parts	341
Pièces détachées	341
Ersatzteile	341

Índice
Index
Sommaire
Inhaltsverzeichnis

Iconografía

Iconography
Iconographie
Ikonographie



Línea profesional
Professional line



Línea hogar
Home line



Producto ambidiestro
Ambidextrous product

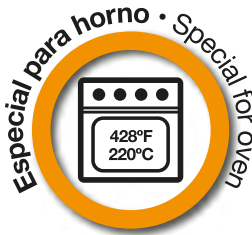

Especial para horno
Special for oven



Gas
Gas



Eléctrica
Electric



Vitrocerámica
Glass-ceramic



Inducción
Induction



Lavavajillas
Dishwasher



Estuche
Gift box



Caja
Box



Tarjeta colgador
Holden card



Bolsa
Polybag



Retractilado
Shrink



Corbata
Tie



Blister
Blister



Tapa vidrio
Glass lid



Tapa acero
Steel lid

Fuego

Fire

Feu

Feuer



Ollas, sartenes, paelleras, freidoras...

Stock pots, fry pans, paelleras, deep-fryers...

Marmites, poêles, paelleras, friteuses...

Fleischtopf, pfanne, paelleras, friteusen...



Base:
STAINLESS
STEEL 18%

Interior:
ALUMINIUM

STAINLESS
STEEL 21%



Hasta Ø 24cm
Until Ø24cm



Acero Inoxidable 21%
Stainless Steel 21%



ESP La *Línea Profesional* está fabricada con los mejores materiales y acabados para el reiterado uso en el mundo profesional. De gran robustez y resistencia tanto en los cuerpos como en las asas, presenta una completa gama en medidas y formas, con fondo encapsulado para todos sus tamaños. Provista de cuidados detalles en su interior y en su presentación, para disfrutar cocinando a diario.

Principales características:

Acero Inoxidable 21% · Fondo difusor · Medidor interior · Máxima robustez

ENG The *Professional Line* is manufactured with the best materials and finished for repeated professional use. With strong and resistant bodies and handles, it represents a complete range of sizes and shapes, all with an encapsulated base. With an exquisitely designed presentation and quality, it is perfect for daily use in the kitchen.

Main characteristics:

Stainless Steel 21% · Thermocore base · Meter inside · Improved strength

FR La *Ligne Professionnelle* est fabriquée avec les meilleurs matériaux et finitions pour une utilisation récurrente en milieu professionnel. Une grande solidité et résistance du corps ainsi que des poignées, elle présente une gamme complète en termes de dimensions et de formes, avec un fond encapsulé sur toutes les tailles. Dotée de détails soignés à l'intérieur, et dans la présentation, pour en profiter en cuisinant chaque jour.

Principales caractéristiques:

Acier Inoxidable 21% · Fond diffuseur · Graduation interne · Plus grande robustesse

DE Die Artikel unserer *Profi-Linie* sind aus hochwertigen Materialien hergestellt und bestens verarbeitet und garantieren eine lange Lebensdauer auch bei intensivem Einsatz unter Profi-Bedingungen. Sowohl Körper als auch Henkel sind robust und beständig. Alle unsere Töpfe und Pfannen, die in verschiedenen Formen und Größen erhältlich sind, haben einen Kapselboden. Viele Details im Inneren und beim Design machen sie zum idealen Begleiter in der Küche.

Hauptmerkmale:

Rostfreier Stahl 21% · Diffusionsboden · Messskala auf der Innenseite · Höhere Widerstandsfähigkeit



EXCELLENT
DURABILITY



MADE WITHOUT
PFOS



REGULATORY
COMPLIANT



OVEN SAFE
500°F | 260



HEALTHFUL
COOKING



EASY CLEAN



Ollas y Cacerola Professional

Professional stock pots and casserole

(págs. 18 y 19)

(pgs. 18 and 19)

Olla superalta Professional

Professional extra-high stock pot

(pág. 18)

(pg. 18)





Olla superalta Professional
Professional extra-high stock pot
Marmite Professional extra-haute
Hoher Fleischtopf Professional



Cacerola alta Professional
Professional deep casserole
Braising Professional
Hoher Grossküchen-Bratentopf Professional



Paellera cónica Professional
Professional conical saucepan
Sauté pan Professional
Sauté pan conical Professional



Paellera cónica antiadherente Professional
Professional conical saucepan with non-stick surface
Sauté pan conical with anti-stick coating Professional
Anti-stick Sauté pan conical Professional



Cazo alto Professional
Professional stock saucepan
Casserole high Professional
Stielkasserolle Professional



Cazo bajo Professional
Professional low saucepan
Casserole low Professional
Stielkasserolle Professional



Cazo vertedor doble Professional
Professional saucepan double pourer
Casserole double beak Professional
Stielkasserolle mit 2 Ausgießtülle Professional



Sautex Professional



Sautex antiadherente Professional
Professional sauté pan with non-stick surface
Sauté pan with anti-stick coating Professional
Sauté pan Anti-stick Professional



Cocedor industrial Professional tapa cristal
Professional asparagus cooker with glass lid
Cuisson à asperges Professional with glass lid
Kochtopf Professional with glass lid



Suplemento olla colador alto
Tall colander pot accessory
Supplement steamer basket Professional
Accessory Siebeinsatz high



Suplemento olla colador
Steamer insert
Element steamer
Siebeinsatz Kochtopf



Cacerola Professional
Professional casserole
Braisière traiteur Professional
Kasserolle für Großküchen Professional



Paellera Professional
Professional paella pan
Poêle à paella Professional
Grossküchen-Paellapfanne Professional



Wok Professional



Wok antiadherente Professional
Professional wok with non-stick surface
Wok à revêtement anti-adhésif Professional
Antihaf wok Professional



Tapa wok Professional
Professional lid wok
Couvercle wok Professional
Deckel wok Professional



Cazo Francés Professional
Professional french saucepan
Casserole Française Professional
Französische Kasserolle Professional



Sartén Profesional antiadherente
Professional non-stick surface frying pan
Poêle Professional antiadhésive
Pfanne Professional Antihaft



Sartén Profesional
Professional frying pan
Poêle Professional
Pfanne Professional



Cazo cónico Professional
Professional conical saucepan
Sauteuse conique Professional
Sauteuse konisch Professional



Sartén Profesional antiadherente con asa reforzada
Professional non-stick surface frying pan
with extra handle
Poêle Professional antiadhésive avec poignée robuste
Pfanne Professional Antihaft robuster griff



Sartén Profesional con asa reforzada
Professional frying pan with extra handle
Poêle Professional avec poignée robuste
Pfanne Professional robuster griff



Olla Baño María Professional con mango con fondo
Professional stock pot double boiler with bottom
Marmite bain-marie Professional avec fond
Bain-Marie-Stieltopf Professional mit Boden



Olla Baño María Professional sin mango
Professional stock pot double boiler without handle
Marmite bain-marie Professional sans manche
Bain-Marie Topf Professional ohne Griff



Cesta de malla Cocedor
Basket for pan
Panier vapeur
Set Kochtopf und Siebeinsatz



Ø (cm)

	14	16	18	20	22	24	26	28	30	32	36	40	45	50	60
		X	X	X	X	X	X	X	X	X	X	X	X	X	
		X	X	X		X		X	X	X	X	X	X	X	
		X	X	X		X		X	X	X	X	X	X	X	X
						X		X	X	X	X	X	X	X	X
						X		X							
				X		X	X	X							
		X													
		X		X		X									
		X	X	X		X									
				X		X		X		X					
		X		X		X									
						X		X							
	X	X													



Ø (cm)

Sartenes, paelleras, sautex, wok y planchas
Stock pots, casseroles and baking pans

Sartenes, paelleras, sautex, wok y planchas
Stock pots, casseroles and baking pans

	16	18	20	22	24	26	28	30	32	36	40	45	50	60
	X	X	X		X		X							
	X	X	X		X		X							
			X		X		X		X					
					X		X		X					
		X	X	X	X	X	X							
									X	X	X			
		X	X	X	X	X	X							
									X	X	X			
									X	X	X			
								X						
								X						



Olla superalta Professional

Professional extra-high stock pot
Marmite Professional extra-haute
Hoher Fleischtopf Professional

Ø pieza (cm)	Ø FONDO (cm)	H (cm)	L	Ref.	€	
16	14	16	3	65597	53,35	8
18	16	18	4,5	65598	61,33	6
20	18	20	6,2	65599	70,96	6
22	19,5	22	8,3	65600	76,82	4
24	22	24	10	65601	89,83	4
26	24	26	13,80	65602	104,51	2
28	26	28	16	65603	115,25	2
30	28	30	21	65604	149,50	2
32	30	32	25	65605	164,76	2
36	34	36	36	65607	214,44	1
40	37,5	40	50	65609	266,76	1
45	43	45	71	65611	368,59	1
50	47	50	98	65613	502,01	1



Acero Inoxidable 21%
Stainless Steel 21%



Hasta Ø 24cm
Until Ø24cm

Cacerola alta Professional

Professional deep casserole
Braising Professional
Hoher Grossküchen-Bratentopf Professional

Ø pieza (cm)	Ø FONDO (cm)	H (cm)	L	Ref.	€	
16	14	11	2,4	65621	48,03	8
18	16	10,5	2,4	65622	51,18	8
20	18	13	4,4	65623	58,00	6
24	22	14	7,2	65625	74,03	4
28	26	17,5	11	65627	96,03	4
30	28	19,5	15	65628	134,78	2
32	30	18	16	65629	138,95	2
36	34	21,5	22	65631	173,77	2
40	37,5	24,5	31	65633	223,33	1
45	43	27,5	44	65635	293,50	1
50	47	30	62	65637	347,43	1



Acero Inoxidable 21%
Stainless Steel 21%



Hasta Ø 24cm
Until Ø24cm

Paellera cónica Professional

Professional conical saucepan
Sautéuse conique Professional
Sautéuse konisch Professional

Ø pieza (cm)	Ø FONDO (cm)	H (cm)	L	Ref.	€	
32	26	5	2	70932	85,83	4
36	30	6	2,70	70936	98,72	2
40	32,5	7	3,70	70940	119,53	2



INOX 21%





Cacerola Professional

Professional casserole
Braising pot Professional
Kasserolle für Großküchen Professional

Ø pieza (cm)	Ø FONDO (cm)	H (cm)	L	Ref.	€	
16	14	8	1,6	65649	48,26	8
18	16	8,5	2,4	65650	49,61	8
20	18	9	3	65651	54,51	6
24	22	9,5	4,5	65653	68,67	6
28	26	11	7	65655	92,60	4
30	28	11,5	8,5	65656	121,02	2
32	30	12,5	10	65657	134,96	2
36	34	14	14	65659	156,84	2
40	37,5	15,5	19	65661	196,61	1
45	43	17	27	65663	264,45	1
50	47	20	38	65665	330,75	1
60	57	25	70	65699	448,71	1



Acero Inoxidable 21%
Stainless Steel 21%



Hasta Ø 24cm
Until Ø24cm



Paellera Professional

Professional paella pan
Poêle à paella Professional
Grossküchen-Paellapfanne Professional

Ø pieza (cm)	Ø FONDO (cm)	H (cm)	L	Ref.	€	
24	22	6	2,70	65666	63,11	4
28	26	6	3,70	65679	81,65	6
30	28	7	4,5	65670	96,98	4
32	30	7	4,70	65680	108,95	4
36	34	7	7	65681	141,01	4
40	37,5	8	10	65683	182,41	2
45	43	8,5	13,5	65685	228,40	2
50	47	9	17,65	65687	293,48	2
60	57	9	27	65689	418,49	-

* 50 47 16 31 65677 312,42 -



Acero Inoxidable 21%
Stainless Steel 21%



Hasta Ø 24cm
Until Ø24cm



* Medidas especiales / special measures
Dimensions spéciales / Sondermaße

Paellera cónica antiadherente Professional

Professional conical saucepan with non-stick surface
Sautéuse conique à revêtement anti-adhésif Professional
AntihafSauteuse konisch Professional

Ø pieza (cm)	Ø FONDO (cm)	H (cm)	L	Ref.	€	
32	26	5	2	70933	106,24	4
36	30	6	2,70	70937	123,42	2
40	32,5	7	3,70	70941	157,70	2



INOX 21%





Suplemento olla colador alto

Tall colander pot accessory
Supplément panier cuit-vapeur haut
Zubehör Siebeinsatz hoch

Ø (cm)	H (cm)	L	Ref.	€	
24	17	9,5	65394	68,98	4
28	24,5	14,5	65398	83,25	4

INOX 21%



Suplemento olla colador

Steamer insert
Élément vapeur
Siebeinsatz Kochtopf

Ø (cm)	H (cm)	Ref.	€	
20	10	67139	44,04	6
24	11	67140	57,04	6
26	11,5	67142	62,01	6
28	12	67144	71,93	6

INOX 21%



Tapas sueltas

Spare lids
Couvercles
Glasdeckel

Ø (cm)	Ref.	€	
16	65801	9,60	-
18	65768	10,98	6
20	65802	12,35	5
22	65812	14,34	5
24	65803	16,53	6
26	65813	18,63	-
28	65804	20,50	6
30	65811	23,19	5
32	65805	29,30	5
36	65806	35,78	-
40	65807	41,66	-
45	65808	53,28	6
50	65809	62,52	6
60	65810	74,09	4

INOX 21%

Cocedor industrial Professional tapa cristal

Professional asparagus cooker with glass lid
Cuiseur à asperges Professional avec couverde verre
Kochtopf Professional mit glasdeckel

Ø pieza (cm)	Ø FONDO (cm)	H (cm)	L	Ref.	€	
16	14	24	4,5	67136	72,91	4



INOX 21%



Cestillo de acero inoxidable
Stainless steel basket
Panier en acier inoxydable
Korb aus rostfreiem Stahl

Olla Baño María Professional con mango con fondo

Professional stock pot double boiler with bottom
Marmite bain-marie Professional avec fond
Bain-Marie-Stieltopf Professional mit Boden

Ø pieza (cm)	Ø FONDO (cm)	H (cm)	L	Ref.	€	
16	14	16	3	65616	38,18	-
20	18	20	6,2	65620	50,44	-
24	22	24	10	65624	69,29	-



INOX 21%



Olla Baño María Professional sin mango

Professional stock pot double boiler without handle
Marmite bain-marie Professional sans manche
Bain-Marie Topf Professional ohne Griff

Ø pieza (cm)	Ø FONDO (cm)	H (cm)	L	Ref.	€	
16	14	16	3	65636	25,46	-
18	16	18	4,5	65638	29,23	-
20	18	20	6,2	65640	38,42	-
24	22	24	10	65644	53,74	-

INOX 21%





Cazo vertedor doble Professional
Professional saucepan double pourer
Casserole double bec verseur Professional
Stielkasserole mit 2 Ausgießtülle Professional

Ø pieza (cm)	Ø FONDO (cm)	H (cm)	L	Ref.	€	
14	12	7	1	65698	31,62	12
16	14	8	1,5	65700	35,98	14



INOX 21%



Hasta Ø 24cm
Until Ø24cm



El diseño de su borde, lo hace especialmente indicadas para zurdos y diestros.

The edges are especially designed for use by left and right-handed people alike.

Le design de leur bord les rend tout particulièrement idéales pour gauchers et droitiers.

Dank des Randdesigns für Links- und Rechtshänder gleichermaßen geeignet.



Cesta de malla cocedor
Basket for pan
Panier vapeur
Set Kochtopf und Siebeinsatz

Ø (cm)	H (cm)	Ref.	€	
24	13,5	67134	58,03	6
28	15,5	67138	74,41	6
32	15,5	67141	90,52	-

ACERO NIQUELADO



Cazo profesional salsas
Professional pouring saucepan
Casserole à sauce professional
Professional saucenpfännchen

Ø (cm)	Ref.	€	
12	14007	11,12	20



INOX 18%





Cazo alto Professional
Professional stock saucepan
Casserole haute Professional
Stielkasserolle Professional

Ø pieza (cm)	Ø FONDO (cm)	H (cm)	L	Ref.	€	
16	14	12	2,4	65691	38,70	6
18	16	14	3,4	65692	45,61	8
20	18	14	4,4	65693	50,54	6
24	22	16	7,2	65695	63,41	4
28	26	17,5	10,2	65697	87,23	4



INOX 21%



Hasta Ø 24cm
Until Ø24cm



Asa reforzada para:
Extra handle for:
Poignée robuste pour:
Robuster Griff für:

Ø 24 cm Ø 28 cm

Cazo bajo Professional
Professional low saucepan
Casserole bas Professional
Stielkasserolle Professional

Ø pieza (cm)	Ø FONDO (cm)	H (cm)	L	Ref.	€	
16	14	9,5	1,9	65701	34,86	10
18	16	10,5	2,3	65702	40,16	8
20	18	11	3,3	65703	43,48	8
24	22	11	5	65705	54,36	6
28	26	11	6,7	65707	77,90	6



INOX 21%



Hasta Ø 24cm
Until Ø24cm



Asa reforzada para:
Extra handle for:
Poignée robuste pour:
Robuster Griff für:

Ø 24 cm Ø 28 cm

Cazo Francés Professional
Professional french saucepan
Casserole Française Professional
Französische Kasserolle Professional

Ø pieza (cm)	Ø FONDO (cm)	H (cm)	L	Ref.	€	
24	22	7,5	3	65708	51,68	10
28	26	13	8,5	65709	83,21	10



INOX 21%



Hasta Ø 24cm
Until Ø24cm



Asa reforzada para:
Extra handle for:
Poignée robuste pour:
Robuster Griff für:

Ø 28 cm

Cazo cónico Professional
Professional conical saucepan
Sauteuse conique Professional
Sauteuse konisch Professional

Ø pieza (cm)	Ø FONDO (cm)	H (cm)	L	Ref.	€	
16	10,2	6	1	65711	33,22	12
20	14	6,5	1,6	65713	40,50	12
24	18	7,5	2,4	65715	50,94	10



INOX 21%





Sartén Profesional

Professional frying
Poêle Professional
Pfanne Professional



Ø pieza (cm)	Ø FONDO (cm)	H (cm)	Ref.	€	
18	12	4	65719	31,94	12
20	15	4	65721	37,62	12
22	16	4,5	65742	42,74	10
24	18	4,5	65723	43,43	10
26	19,5	5	65746	49,41	10
28	22	5	65725	59,45	6



INOX 21%



Sartén Profesional con asa reforzada

Professional frying pan with extra handle
Poêle Professional avec poignée robuste
Pfanne Professional robuster griff



Ø pieza (cm)	Ø FONDO (cm)	H (cm)	Ref.	€	
32	26	5,5	65727	77,42	4
36	30	6	65729	100,32	4
40	32,5	6,5	65731	123,84	2



INOX 21%



Sautex Profesional



Asa reforzada para:
Extra handle for:
Poignée robuste pour:
Robuster Griff für:

Ø **32** cm

Ø pieza (cm)	Ø FONDO (cm)	H (cm)	L	Ref.	€	
20	18	6	2	65753	38,21	10
24	22	6,5	2,70	65755	46,40	10
28	26	7	3,70	65757	65,50	6
32	30	7	4,70	65759	86,60	4



INOX 21%



Hasta Ø 24cm
Until Ø24cm

Wok Profesional



Ø pieza (cm)	Ø FONDO (cm)	H (cm)	Ref.	€	
30	16	8,5	65749	68,81	4



INOX 21%



Tapa wok Profesional

Professional lid wok
Couvercle wok Professional
Deckel wok Professional



Ø (cm)	Ref.	€		
30	34434	17,55	-	

Sartén Profesional antiadherente

Professional Non-stick surface frying pan
Poêle Professional antiadhésive
Pfanne Professional Antihaft

Ø pieza (cm)	Ø FONDO (cm)	H (cm)	Ref.	€	
18	12	4	65718	37,90	12
20	15	4,5	65720	43,92	12
22	16	5	65722	51,21	10
24	18	5,5	65724	53,93	10
26	19,5	6	65726	61,82	10
28	22	6,5	65728	72,96	6



INOX 21%



Sartén Profesional antiadherente con asa reforzada

Professional Non-stick surface frying pan with extra handle
Poêle Professional antiadhésive avec poignée robuste
Pfanne Professional Antihaft robuster griff

Ø pieza (cm)	Ø FONDO (cm)	H (cm)	Ref.	€	
32	26	5,5	65732	94,97	4
36	30	6	65736	120,24	4
40	32,5	6,5	65740	150,67	2



INOX 21%



Sautex antiadherente Professional

Professional sautex with non-stick surface
Sautex à revêtement anti-adhésif Professional
Sautex Antihaft Professional

Ø pieza (cm)	Ø FONDO (cm)	H (cm)	L	Ref.	€	
24	22	6	2,4	65754	67,48	10
28	26	7,5	4,2	65756	80,89	6
32	30	7,5	5,2	65758	116,80	4



INOX 21%



Asa reforzada para:
Extra handle for:
Poignée robuste pour:
Robuster Griff für:
Ø **32** cm

Wok antiadherente Professional

Professional wok with non-stick surface
Wok à revêtement anti-adhésif Professional
Antihaftwok Professional

Ø pieza (cm)	Ø FONDO (cm)	H (cm)	Ref.	€	
30	16	8,5	65750	95,09	4



INOX 21%





Recetas sencillas para disfrutar sin bobadas

Simple recipes for simple meals

26

Recipes by *Maikel de Jorge*

ROBIN FOOD



Ragú de ñoquis
Gnocchi ragout

pág. 316

page 316

Recipes

#pasionporlacocina





Pasión
por la **cocina**
Passion for Cooking
Passion pour la Cuisine
Liebe zur Küche

Sartén Profesional antiadherente con asa reforzada
Professional Non-stick surface frying pan with extra handle
Poêle Professionnelle antiadhésive avec poignée robuste
Pfanne Professional Antihaft robuster griff

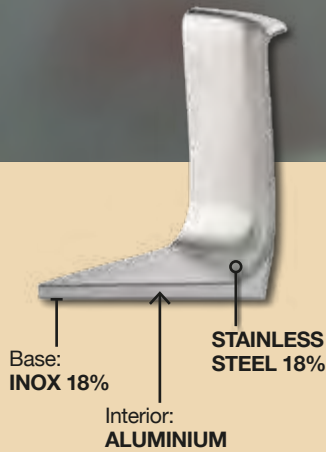

INOX 18%



28

ESP Batería por piezas en acero inoxidable 18% de máxima calidad. Cacerolas altas con mayor capacidad que la media. Asas remachadas de gran robustez con 4 puntos de anclaje. Apta para todo tipo de cocinas, incluida la inducción. **Los cuerpos y las tapas se venden por separado.**

Principales características:

Inox 18% · Máxima robustez · Venta por piezas sueltas.

ENG Top-quality, 18% stainless steel cookware items. High saucepans with larger-than-average capacity. Sturdy, 4-riveted handles. Suitable for all types of cookers, including induction. **Bodies and lids sold separately.**

Main characteristics:

Inox 18% · Improved strength · Parts sold separately.



MADE WITHOUT
PFOS



REGULATORY
COMPLIANT



HEALTHFUL
COOKING



EASY CLEAN

FR Batterie par pièces en acier inoxydable 18 %, d'excellente qualité. Casseroles hautes d'une plus grande capacité que la moyenne. Poignées rivetées d'une grande robustesse avec 4 points de fixation. Apte pour tout type de cuisinière, y compris à induction. **Les corps et couvercles sont vendus séparément.**

Principales caractéristiques:

Inox 18% · Plus grande robustesse · Vente par pièces séparées.

DE Hochwertiges Topfset aus Edelstahl 18% Hochwertige Stieltöpfe mit überdurchschnittlichem Fassungsvermögen. Robuste genietete Griffe mit 4 Befestigungspunkten. Geeignet für alle Herdtypen, einschließlich Induktio. **Körper und Deckel sind separat erhältlich.**

Hauptmerkmale:

Inox 18% · Höhere Widerstandsfähigkeit · Auch einzeln erhältlich.

Tapa Star	(pág. 31)
Star lid	(pg. 31)
Olla Star sin tapa	(pág. 31)
Star stockpot without lid	(pg. 31)
Cacerola media Star sin tapa	(pág. 31)
Star medium stockpot without lid	(pg. 31)





Ø (cm)

	32	36	40	45	50
	X	X			X
	X	X	X	X	X
	X	X	X	X	X
	X	X	X	X	X
	32	36	40	45	50



Olla Star sin tapa

Star stock pot without lid
Marmite Star sans couvercle
Fleischtopf Star ohne Deckel

Ø (cm)	H (cm)	L	Ref.	€	
32	32	25	65568	117,88	-
36	36	36,6	65569	153,26	-
50	50	98,2	65570	349,03	-



INOX 18%

Cacerola alta Star sin tapa

Star high stock pot without lid
Faitout haute Star sans couvercle
Bratentopf Star ohne Deckel

Ø (cm)	H (cm)	L	Ref.	€	
32	20	16,1	65571	94,29	-
36	30	30,5	65572	128,50	-
40	30	37,3	65573	165,06	-
45	36	57,3	65574	212,23	-
50	40	78,5	65575	282,99	-



INOX 18%

Cacerola media Star sin tapa

Star medium stock pot without lid
Faitout demi Star sans couvercle
Bratentopf Star ohne Deckel

Ø (cm)	H (cm)	L	Ref.	€	
32	12	14	65576	82,50	-
36	14	14,3	65577	101,37	-
40	15	18,8	65578	117,88	-
45	15	23,9	65579	148,54	-
50	15	29,5	65580	188,64	-



INOX 18%

Tapa Star

Star lid
Couvercle Star
Deckel Star

Ø (cm)	Ref.	€	
32	65561	23,53	-
36	65562	27,06	-
40	65563	35,33	-
45	65564	42,40	-
50	65565	50,65	-

INOX 18%





INOX 18/10



ESP Batería en acero inoxidable 18/10 semi profesional, con terminación brillo y franja decorativa, robusta, con fondo difusor y asas sólidas, apta para todos los fuegos. Piezas de líneas sobrias, rectas, manejable, de diseño sencillo y elegante, pensada tanto para uso profesional como doméstico.
“Una batería que te hará ser un experto de la cocina”

Principales características:

Inox 18/10 · Fondo difusor · Máxima robustez · Terminación brillo y franja decorativa

ENG Semi-professional 18/10 stainless steel cookware, with shiny finish and robust, decorative strip, with diffuser bottom and solid handles, suitable for all types of heat sources. Simply and elegantly designed, easy to use and devised for professional and domestic use like.
“Cookware that will turn you into a kitchen expert”

Main characteristics:

Inox 18/10 · Thermocore base · Improved strength · Gloss finish and decorative fringe

FR Batteries en acier inoxydable 18/10 semi-professionnelles, avec finition brillante et bande décorative, robuste, avec fond diffuseur et des poignées solides, apte pour tous les feux. Pièces de lignes sobres, droites, maniables, au design simple et élégant, conçues aussi bien pour un usage professionnel que domestique.
“Une batterie qui fera de vous un expert de la cuisine”

Principales caractéristiques:

Inox 18/10 · Fond diffuseur · Plus grande robustesse · Finition brillante et bande décorative

DE Semi-professionelles Topfset aus 18/10 Edelstahl, glänzende Oberfläche, Zierrand, robust, mit Wärmeverteilerboden und soliden Griffen, für alle Herdarten geeignet. Einfaches, elegantes Design mit geraden Linien, sowohl für Zuhause als auch für Gastronomie und Großküchen geeignet.
“Ein Topfset für Kochfans”

Hauptmerkmale:

Inox 18/10 · Diffusionsboden · Höhere Widerstandsfähigkeit · Hochglanzoberfläche und Zierstreifen



EXCELLENT DURABILITY



MADE WITHOUT PFOS



REGULATORY COMPLIANT



HEALTHFUL COOKING



EASY CLEAN

Olla y cazo alto Expert
Expert stock pot and stock saucepan

(págs. 36 y 37)
(pgs. 36 and 37)



Expertline



Olla Expert superalta
Expert extra-high stock pot
Marmite Expert extra-haute
Hoher Fleischtopf Expert



Olla Expert
Expert stock pot
Marmite Expert
Fleischtopf Expert



Cacerola Expert con tapa
Expert casserole with lid
Faitout Expert avec couvercle
Bratentopf Expert mit Deckel



Tartera Expert
Expert baking pan
Sauteuse Expert
Pfanne Expert



Cazo alto Expert sin tapa
Expert stock saucepan without lid
Casserole haute Expert sans couvercle
Stielkasserolle Expert ohne Deckel



Cazo Expert
Expert saucepan
Casserole Absolut Expert
Stielkasserolle Expert



Tapas sueltas
Spare lids
Couvercles
Glasdeckel

Ø (cm)

	16	18	20	22	24	26	28	30	32
			X		X		X		X
	X	X	X	X	X	X	X	X	X
	X	X	X	X	X	X	X	X	X
					X		X		X
	X								
	X								
	X	X	X	X	X	X	X	X	X
	16	18	20	22	24	26	28	30	32



Olla Expert superalta
Expert extra-high stock pot
Marmite Expert extra-haute
Hoher Fleischtopf Expert

Ø (cm)	H (cm)	L	Ref.	€	
20	20	6,25	62320	69,53	-
24	22	10	62324	83,38	-
28	24	15	62328	102,87	-
32	26	20	62332	135,15	-



INOX 18/10



Olla Expert
Expert stock pot
Marmite Expert
Fleischtopf Expert

Ø (cm)	H (cm)	L	Ref.	€	
16	13	2,5	62116	54,38	-
18	14	3,5	62118	55,61	-
20	14,5	4,5	62120	62,83	-
22	14,8	5,5	62122	68,79	-
24	15	6,5	62124	73,23	-
26	16	8	62126	80,75	-
28	19	13	62128	95,09	-
30	21	15	62130	104,50	-
32	23	17	62132	125,74	-



INOX 18/10



Cacerola Expert con tapa
Expert casserole with lid
Faitout Expert avec couvercle
Bratentopf Expert mit Deckel

Ø (cm)	H (cm)	L	Ref.	€	
16	7,5	1,5	62016	48,70	-
18	8	2	62018	52,30	-
20	8,5	2,5	62020	57,43	-
22	9	3	62022	63,20	-
24	9,5	4	62024	66,95	-
26	10	5	62026	74,77	-
28	11	6,5	62028	81,41	-
30	11,5	8	62030	93,12	-
32	12,5	9	62032	106,25	-



INOX 18/10

Tartera Expert

Expert baking pan
Sauteuse Expert
Pfanne Expert

Ø (cm)	H (cm)	L	Ref.	€	
24	6,5	3	62224	64,65	-
28	7	4	62228	75,86	-
32	8,5	5	62232	99,26	-



INOX 18/10

**Cazo alto Expert sin tapa**

Expert Stock saucepan without lid
Casserole haute Expert sans couvercle
Stielkasserolle Expert ohne Deckel

Ø (cm)	H (cm)	L	Ref.	€	
16	13	2,5	62216	39,15	-



INOX 18/10

**Cazo Expert sin tapa**

Expert saucepan without lid
Casserole Absolut Expert sans couvercle
Stielkasserolle Expert ohne Deckel

Ø (cm)	H (cm)	L	Ref.	€	
16	7,5	1,5	62316	34,17	-



INOX 18/10

**Tapas sueltas**

Spare lids
Couvercles
Glasdeckel

Ø (cm)	Ref.	€	
16	62816	16,31	-
18	62818	16,70	-
20	62820	17,82	-
22	62822	18,06	-
24	62824	21,00	-
26	62826	21,86	-
28	62828	22,93	-
30	62830	26,01	-
32	62832	30,38	-

INOX 18/10



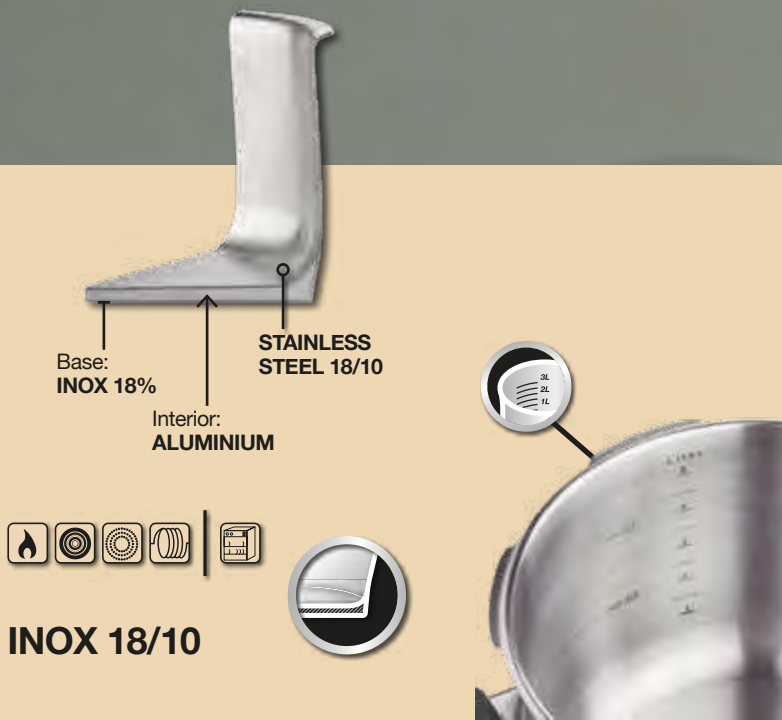

INOX 18/10

ESP Olla a presión de acero inoxidable 18/10 de máxima calidad. Acabado pulido espejo exterior. Marcaje interior, grabado con la capacidad del uso de la olla. Visualizador de los niveles de cocción mediante anillas de colores. 2 niveles de cocción: rápida y súper rápida. Cierre fácil y seguro, su mango ergonómico permite una apertura sencilla y práctica. Triple sistema de seguridad. Apta para todo tipo de cocinas.

Principales características:

Inox 18/10 · Marcaje interior · 2 niveles de cocción · Triple sistema de seguridad

ENG Pressure cooker high-quality 18/10 stainless steel. Exterior mirror-polished finish. Inner marking, engraved with the cooker's capacity. Cooking level indicator-display using coloured rings. 2 cooking levels: fast and super-fast. Easy and safe closing, ergonomic handle enables easy and handy opening. Triple safety system. Suitable for all types of hobs.

Main characteristics:

Inox 18/10 · Thermocore base · Meter inside · 2 cooking levels · Triple safety system

FR Cocotte à pression, acier inoxydable 18/10 de qualité maximale. Finition polissage miroir extérieur. Marquage intérieur, gravé de la capacité d'utilisation de l'autocuiseur. Visualisateur des niveaux de cuisson via anneaux de couleur. 2 niveaux de cuisson: rapide y super rapide. Fermeture facile et sûre, grâce à son manche ergonomique, permet une ouverture simple et pratique. Triple système de sécurité. Apte pour tout type de cuisinières.

Principales caractéristiques:

Inox 18/10 · Fond diffuseur · Graduation interne · 2 niveaux de cuisson · Triple système de sécurité

DE Schnellkochtopf, edelstahl 18/10, bester Qualität mit Hochglanzschliff an der Außenseite. Innenmarkierung, füllstandsanzeige mit Min-Max-Gravierung. Druckanzeige: Anzeige der Garstufen mittels farbigen Ringmarkierungen. 2 Garstufen. Einfacher und sicherer Verschluss, Praktischer ergonomischer Griff erleichtert das Öffnen. Dreifaches Sicherheitssystem. Für alle Herdarten geeignet.

Hauptmerkmale:

Inox 18/10 · Diffusionsboden · Messskala auf der Innenseite · 2 Garstufen · Dreifaches Sicherheitssystem





Olla a presión G - SOLA
 G -SOLA pressure cooker
 Cocotte à pression G -SOLA
 Schnellkochtopf G -SOLA

Ø pieza (cm)	Ø FONDO (cm)	H (cm)	L	Ref.	€	
22	17,5	11,5	4	50270	104,12	4
22	17,5	17	6	50271	118,97	4
24	19	18	8	50273	142,95	2



INOX 18/10



Libro de recetas de regalo
 Book of recipes free

Varios niveles de cocción: rápida y súper rápida.
 Two cooking speeds: fast and super-fast.



40



Set 2 ollas a presión G - SOLA
 G -SOLA set 2 pressure cooker
 Set 2 cocotte à pression G -SOLA
 Set 2 schnellkochtopf G -SOLA

Ø (cm)	L	Ref.	€	
22	4 + 6	50272	185,15	-

- **Olla** - Pressure cooker: 6 L (Ø 22 cm)
- **Olla** - Pressure cooker: 4 L (Ø 22 cm)
- **Tapa olla a presión** - Pressure cooker's lid
- **Tapa de cristal**- Glass lid (Ø 22 cm)
- **Cestillo** - Basket



INOX 18/10



Libro de recetas de regalo
 Book of recipes free

Cesta perforada-colador

Colander-strainer
Passoire-égouttoir
gelochter Korb-Durchschlag



Ø (cm)	H (cm)	Ref.	€	
21	13	50211	21,15	10

INOX 18/10

**Cesta perforada-colador mango varilla**

Colander-strainer wire handle
Passoire-égouttoir manche fil
gelochter Korb-Durchschlag Drahtgriff



Ø (cm)	H (cm)	L	Ref.	€	
21	13	4	50215	28,33	6

INOX 18/10

**Cesta perforada-colador + soporte**

Colander-strainer + sup
Panier perforé-passoire + support
gelochter Korb-Durchschlag + Ständer



Ø (cm)	H (cm)	L	Ref.	€		
21	4,5	1,5	50218	9,95	-	(*)
21	7,5	2	50217	10,85	-	

INOX 18%

* con una sola asa
with a single handle

**Junta silicona olla a presión G - Sola**

G -SOLA Silicone ring pressure cookerjoint
silicone cocotte à pression G -SOLA
Deckeldichtung schnellkochtopf G -SOLA

Ø (cm)	Ref.	€	
22	55191	11,41	-
24	55189	12,95	-

**Tapa de cristal**

Glass lid
Couvercle verre
Glasedeckel

Ø (cm)	Ref.	€	
22	55198	9,11	-
24	65985	8,80	-





INOX 18/10



ESP Batería para hogar en acero inoxidable 18/10, con fondo y asas robustas, y con el añadido del sistema “SELLO DE AGUA”, un sistema de cocción para lograr un sabor intenso y saludable con el máximo ahorro de energía, especial de Inoxibar.

Principales características:
Inox 18/10 · Sello de agua · Tapas en acero o cristal

ENG Cookware for the home in 18/10 stainless steel, with robust bases and handles and with the bonus of the “WATER SEAL” system, a cooking system for achieving an intense, healthy flavour with maximum energy savings, special from Inoxibar.

Main characteristics:
Inox 18/10 · Thermocore base · Water seal · Steel lid / glass lid

FR Batterie pour la maison en acier inoxydable 18/10, avec fond et poignées robustes et avec l’avantage du système « JOINT D’EAU », un système de cuisson pour parvenir à une saveur intense et saine avec le maximum d’économie d’énergie, spécial d’Inoxibar.

Principales caractéristiques:
Inox 18/10 · Fond diffuseur · Joint d’eau · Couvercle en acier / en verre

DE Artikel für Privatküchen aus Edelstahl 18/10, mit Böden und robusten Griffe und mit dem speziell von Inoxibar verwendetem WASSERSIEGEL-Kochsystem für besonders intensiven Geschmack und gesunde und energiesparende Zubereitung.

Hauptmerkmale:
Inox 18/10 · Diffusionsboden · Wassersiegel · Deckel aus Stahl / Deckel aus Glas



MADE WITHOUT
PFOS



REGULATORY
COMPLIANT



HEALTHFUL
COOKING



EASY CLEAN

Eccoline

Cacerola Ecco Acero
Ecco Acero casserole

(pág. 50)
(pg. 50)

Conjunto vapor cacerola y cocedor
Steam casserole set and cooker

(pág. 51)
(pg. 51)



43

Eccoline



Olla Ecco Acero superalta
Ecco Acero extra-high stock pot
Marmite Ecco Acero extra-haute
Hoher Fleischtopf Ecco Acero



Olla Ecco Acero con tapa
Ecco Acero stock pot with lid
Marmite Ecco Acero avec couvercle
Fleischtopf Ecco Acero mit Deckel



Cacerola Ecco Acero con tapa
Ecco Acero casserole with lid
Faitout Ecco Acero avec couvercle
Bratentopf Ecco Acero mit Deckel



Tartera Ecco Acero con tapa
Ecco Acero baking pan with lid
Sauteuse Ecco Acero avec couvercle
Pfanne Ecco Acero mit Deckel



Conjunto vapor olla y cocedor
Steam stock pot set and supplement
Ensemble marmite vapeur et supplement
Dampfkochset und Zubehör



Conjunto vapor cacerola y cocedor
Steam casserole set and cooker
Ensemble faitoutvapeur et cuiseur
Bratentopf und Druck

44

Otras piezas · Other components



Sautex Ecco Acero
Ecco Acero sautex
Sautex Ecco Acero
Sautex Ecco Acero



Pote Ecco Acero sin tapa
Ecco Acero pot without lid
Gobelet Ecco Acero sans couvercle
Milchtopf Ecco Acero



Cazo Ecco Acero sin tapa
Ecco Acero saucepan without lid
Casserole Ecco Acero sans couvercle
Stielkasserolle Ecco Acero flach ohne Deckel

Sartenes · Frypan · Poêle · Pfanne



Sartén Ecco
Ecco fry pan
Poêle Ecco
Pfanne Ecco



Olla Ecco Cristal superalta
Tall Ecco Cristal pot
Marmite Ecco Cristal extra haute
Topf Ecco Glas extrahoch



Olla Ecco Cristal
Ecco Cristal pot
Marmite Ecco Cristal
Topf Ecco Glas



Cacerola Ecco Cristal
Ecco Cristal casserole dish
Faitout Ecco Cristal
Topf Ecco Glas



Tartera Ecco Cristal
Ecco Cristal cake pan
Sauteuse Ecco Cristal
Bräter Ecco Glas



Conjunto vapor olla y cocedor Ecco Cristal
Ecco Cristal steam pot and boiler set
Ensemble vapeur marmite y cuiseur Ecco Cristal
Dampfkoch-Duo Koch Topf und hoher Kochtopf Ecco Glas



Conjunto vapor cacerola y cocedor Ecco Cristal
Ecco Cristal steam casserole and boiler set
Ensemble vapeur braisière et cuiseur Ecco Cristal
Dampfkoch-Duo Kochtopf und hoher Kochtopf Ecco Glas

Otras piezas · Other components



Freidora cazo Ecco con cestillo
Ecco chip pan with basket
Casserole à friture Ecco avec panier
Frittiertopf Ecco mit Frittierensatz



Escurridor Ecco Acero
Ecco Acero colander
Passoires Ecco Acero
Durchschiag Ecco Acero

Sartenes · Frypan · Poêle · Pfanne

Sartén Style Ecco
Style Ecco fry pan
Poêle à revêtement anti-adhésif Style Ecco
Antihaftpfanne Style Ecco



Sello de agua, un sistema de cocción único
Water seal, a unique cooking system
Joint d'eau, un système de cuisson unique
Wassersiegel, ein einzigartiges Garsystem



(*) exclusivo de la batería Ecco Acero · Only for Ecco Acero



¿Qué es el sello de agua?

Es una película fina de agua que se genera durante la cocción en la unión entre la tapa y la olla.

Gracias a la geometría de las piezas de la serie ecco el vapor que se genera al inicio de la cocción se dirige a la unión entre la tapa y la olla formándose así el "sello de agua".

What is a water seal?

A water seal is a thin film of water that forms between the lid and the pot during cooking.

The ecco series cookware is designed so that any steam produced when you start cooking is directed to the gap between the lid and the pot, thus forming the "water seal".

46

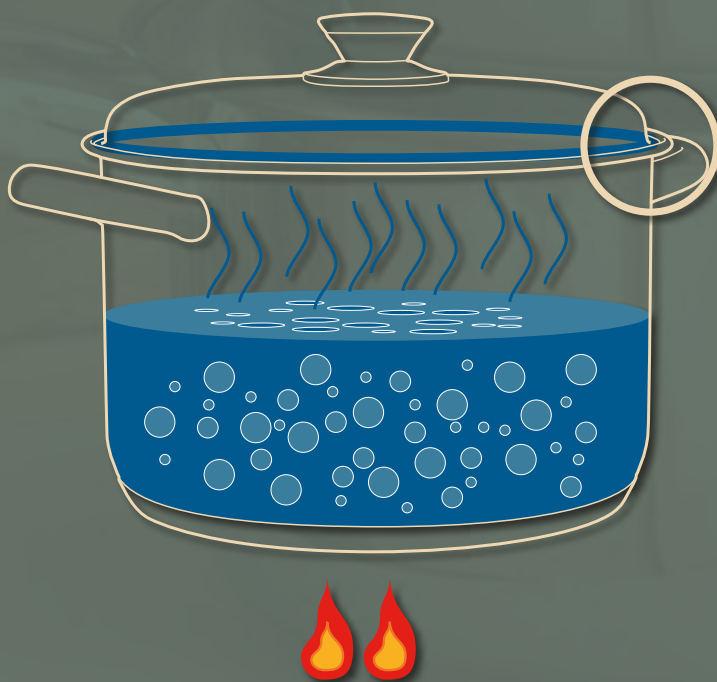

Sello de agua
 Water seal
 Joint d'eau
 Wassersiegel

Ventajas

El sello de agua nos permite cocinar con un mínimo de agua los alimentos, sin someterlos a altas temperaturas de forma que estos conserven la intensidad de sus sabores así como sus nutrientes naturales. También permite cocinar sin aceites ni grasas, aunque pueden ser añadidos a gusto de cada persona.

Por otro lado las piezas de la serie ecco pueden se utilizadas también para realizar la cocción tradicional, siendo el sello de agua una forma de cocinar que precisa, además de unos utensilios adecuados con la geometría correcta, unas reglas básicas que debemos seguir.

Advantages

A water seal lets you cook any food with a small amount of water, without overheating it so that the food retains all its flavours and its natural nutrients. It also lets you cook food without any oil or fat, although you can add some to suit your own taste.

You can also use the ecco series cookware for traditional cooking, and cooking with a water seal is a method that not only calls for properly-designed, appropriate utensils, but involves following a few basic rules too.

Instrucciones

Instructions

Se recomienda que los alimentos no superen los 3/4 de la capacidad de la pieza. Tampoco es conveniente que esté demasiado vacía ya que estaremos desperdiciando energía. Por lo tanto es recomendable cocinar entre 1/2 y 3/4 de la capacidad de la olla.

The cookware should not be filled more than three-quarters capacity with the food you are preparing, nor should be it be too empty, otherwise you will waste energy. So it is best if the cookware is filled to between half and three-quarters capacity.

1 Comience a cocinar a fuego medio

Colocar los alimentos limpios en la olla y agregar un mínimo de agua para que empiece la cocción. Tapar la olla y esperar hasta que empiece a salir vapor. A partir de ese momento se irá generando el sello de agua.

Start cooking on medium heat

Place the clean food in the pot and add a little water so that it starts cooking. Cover the pot and wait until steam starts coming out. That is when the water seal will start to form.

Para comprobarlo lo más sencillo es hacer girar la tapa suavemente. Si esta gira sin dificultad el sello de agua está formado.

The best way to check it is to turn the lid very slowly, and it turns easily, then the water seal has formed.

2 Bajar la intensidad del fuego

Una vez se haya formado el sello de agua, reduzca el fuego al mínimo de forma que no salga vapor por la tapa. Durante la cocción podrá comprobar el estado de los alimentos así como la presencia de humedad en el recipiente. Se pueden añadir pequeñas cantidades de agua para mantener el nivel de humedad, aunque hay que tener en cuenta que cada vez que destapamos la olla dejamos escapar humedad así como calor.

Turn down the heat

Once the water seal has formed, turn the heat right down so that no steam comes out of the lid. Check the food every now and then while it is cooking, and see if there is enough moisture in the recipient. You can add small amounts of water to maintain the moisture content, but remember that moisture and heat will be lost every time you remove the lid.

3 Terminada la cocción, destapar y servir los alimentos







Si se deja la olla tapada y al cabo de un tiempo se observa cierta dificultad para retirar la tapa, bastará calentar ligeramente la olla para eliminar la resistencia.

When the food has been cooked, remove the lid and serve it.

If you leave the lid on the pot and find it hard to remove after a certain time, just reheat the pot on low heat until the lid loosens enough to remove it.









Ø (cm)

	14	16	18	20	22	24	26	28	30	32
		X		X		X		X		X
	X	X	X	X	X	X	X	X	X	X
	X	X	X	X	X	X	X	X	X	X
		X		X	X	X	X	X	X	X
				X		X		X		
				X		X		X		

48

Otras piezas
Other components

				X		X		X		
				X	X	X				
			X							
				X						
 	Sartenes			X	X	X	X	X		
	14	16	18	20	22	24	26	28	30	32

New

Ø (cm)

	12	14	16	18	20	22	24	26	28	30	32
			X		X		X		X		X
		X	X	X	X	X	X	X	X	X	X
		X	X	X	X	X	X	X	X	X	X
			X		X	X	X	X	X	X	X
					X		X		X		
					X		X		X		

Otras piezas
Other components

		X	X	X							
	X	X	X	X							
		X	X	X	X	X	X	X	X	X	X
		X	X	X	X	X	X	X	X	X	X
	Sartenes				X	X	X	X	X		
	12	14	16	18	20	22	24	26	28	30	32



Olla Ecco Acero superalta
Ecco Acero extra-high stock pot
Marmite Ecco Acero extra-haute
Hoher Fleischtopf Ecco Acero

Ø (cm)	H (cm)	L	Ref.	€	
16	16	3,20	65020	53,82	-
20	20	6,25	66020	60,02	-
24	22	10	67020	73,87	-
28	24	15	68020	92,75	-
32	26	20	69020	125,20	-



INOX 18/10



Olla Ecco Acero
Ecco Acero stock pot
Marmite Ecco Acero
Fleischtopf Ecco Acero

Ø (cm)	H (cm)	L	Ref.	€	
14	11,5	1,5	64024	39,98	-
16	13	2,5	65018	44,64	-
18	14	3,5	65019	45,27	-
20	14,5	4,5	66018	53,34	-
22	14,8	5,5	65022	58,87	-
24	15	6,5	67018	63,75	-
26	16	8	65026	70,29	-
28	19	13	68018	82,74	-
30	21	15	65031	94,97	-
32	23	17	69018	115,43	-



INOX 18/10



Cacerola Ecco Acero
Ecco Acero casserole
Faitout Ecco Acero
Bratentopf Ecco Acero

Ø (cm)	H (cm)	L	Ref.	€	
14	7	1	64114	36,09	-
16	7,5	1,5	65118	39,34	-
18	8	2	65119	42,59	-
20	8,5	2,5	66118	47,53	-
22	9	3	65122	52,76	-
24	9,5	4	67118	56,81	-
26	10	5	65126	64,53	-
28	11	6,5	68118	71,49	-
30	11,5	8	65130	83,20	-
32	12,5	9	69118	95,80	-



INOX 18/10

Tartera Ecco Acero

Ecco Acero baking pan
Sauteuse Ecco Acero
Pfanne Ecco Acero

Ø (cm)	H (cm)	L	Ref.	€	
16	4,5	0,8	65216	38,73	-
20	6	2	66218	45,16	-
22	6	2,5	66222	49,71	-
24	6,5	3	67218	54,92	-
26	6,5	3,5	66226	59,51	-
28	7	4	68218	66,61	-
30	7,5	5	66230	78,12	-
32	8,5	5	69218	88,69	-



INOX 18/10

Conjunto vapor olla y cocedor Ecco Acero

Ecco Acero steam stock pot set and suplement
Ensemble marmite vapeur et suplement Ecco Acero
Dampfkochset und Zubehör Ecco Acero

Ø (cm)	H (cm)	L	Ref.	€	
20	23	-	50200	82,29	-
24	24	-	50250	103,58	-
28	28	-	50260	128,80	-



INOX 18/10

Conjunto vapor cacerola y cocedor Ecco Acero

Ecco Acero steam casserole set and cooker
Ensemble faitout vapeur et cuiseur Ecco Acero
Bratentopf und Druck Ecco Acero

Ø (cm)	H (cm)	L	Ref.	€	
20	17	-	50203	76,44	-
24	18,5	-	50253	97,18	-
28	20	-	50263	117,49	-



INOX 18/10

Suplemento asas acero

Colander pot accessory
Supplément marmite panier
Zubehör Siebeinsatz

Ø (cm)	H (cm)	L	Ref.	€	
20	10	5,5	50208	27,46	-
24	10	5,5	50210	37,01	-
28	12	7	50265	46,07	-

INOX 18/10





Olla Ecco Cristal superalta

Ecco Cristal extra-high stock pot
Marmite Ecco Cristal extra haute
Topf Ecco Glas extrahoch

Ø (cm)	H (cm)	L	Ref.	€	
16	16	3,20	65025	47,80	-
20	20	6,25	66025	52,98	-
24	22	10	67025	65,23	-
28	24	15	68025	83,84	-
32	26	20	69025	114,06	-



INOX 18/10



Olla Ecco Cristal

Ecco Cristal stock pot
Marmite Ecco Cristal
Topf Ecco Glas

Ø (cm)	H (cm)	L	Ref.	€	
14	11,5	1,5	64034	34,57	-
16	13	2,5	65028	38,68	-
18	14	3,5	65029	39,01	-
20	14,5	4,5	66028	46,36	-
22	14,8	5,5	65032	50,82	-
24	15	6,5	67028	55,19	-
26	16	8	65036	61,24	-
28	19	13	68028	73,40	-
30	21	15	65041	83,65	-
32	23	17	65043	101,89	-



INOX 18/10



Cacerola Ecco Cristal

Ecco Cristal casserole dish
Faitout Ecco Cristal
Topf Ecco Glas

Ø (cm)	H (cm)	L	Ref.	€	
14	7	1	64124	30,78	-
16	7,5	1,5	65128	33,42	-
18	8	2	65129	36,25	-
20	8,5	2,5	66128	40,56	-
22	9	3	65132	44,80	-
24	9,5	4	67148	48,32	-
26	10	5	65136	55,49	-
28	11	6,5	68128	62,14	-
30	11,5	8	65140	71,85	-
32	12,5	9	69128	82,27	-



INOX 18/10

Tartera Ecco Cristal

Ecco Cristal baking pan

Sauteuse Ecco Cristal

Bräter Ecco Glas

Ø (cm)	H (cm)	L	Ref.	€	
16	4,5	0,8	65226	32,81	-
20	6	2	66228	38,21	-
22	6	2,5	66232	41,73	-
24	6,5	3	67228	46,36	-
26	6,5	3,5	66236	50,46	-
28	7	4	68228	57,30	-
30	7,5	5	66240	66,80	-
32	8,5	6	66242	75,17	-



INOX 18/10

**Conjunto vapor olla y cocedor Ecco Cristal**

Ecco Cristal steam stock pot set and suplement

Ensemble marmite vapeur et suplement Ecco Cristal

Dampfkochset und Zubehör Ecco Glas

Ø (cm)	H (cm)	L	Ref.	€	
20	23	-	50201	75,28	-
24	24	-	50251	95,02	-
28	28	-	50261	119,47	-



INOX 18/10

**Conjunto vapor cacerola y cocedor Ecco Cristal**

Ecco Cristal steam casserole set and cooker

Ensemble faitoutvapeur et cuiseur Ecco Cristal

Bratentopf und Druck Ecco Cristal

Ø (cm)	H (cm)	L	Ref.	€	
20	17	-	50204	69,43	-
24	18,5	-	50254	88,64	-
28	20	-	50264	108,22	-



INOX 18/10

**Escurreidor Ecco Acero**

Ecco Acero colander

Passoires Ecco Acero

Durchschiag Ecco Acero

Ø (cm)	Ref.	€	
20	65220	16,32	-

INOX 18/10





Sartén Ecco

Ecco fry pan
Poêle Ecco
Pfanne Ecco



Ø (cm)	Fondo contacto Ø (cm)	H (cm)	L	Ref.	€	
20	16	5	1	51521	29,47	8
22	18	5	1,3	51523	31,15	8
24	20	5	1,75	51524	32,83	8
26	22	5	2	51527	36,59	6
28	23,5	5	2,25	51529	40,40	6



INOX 18%



Sautex Ecco Acero

Ecco Acero sautex
Sautex Ecco Acero
Sautex Ecco Acero

Ø (cm)	H (cm)	L	Ref.	€	
20	6	2	65420	32,83	-
22	6,5	2,5	65422	36,63	-
24	6,5	3	65424	39,17	-



INOX 18/10



Cazo Ecco Acero sin tapa

Ecco Acero saucepan without lid
Casserole Ecco Acero sans couvercle
Stielkasserolle Ecco Acero flach ohne Deckel

Ø (cm)	H (cm)	L	Ref.	€	
12	6	0,5	63118	21,53	-
14	7	1	64118	24,24	-
16	7,5	1,5	65318	28,99	-
18	8	2	65320	32,70	-



INOX 18/10



Freidora cazo Ecco con cestillo

Ecco chip pan with basket
Casserole à friture Ecco avec panier
Frittieropf Ecco mit Frittireinsatz

Ø (cm)	H (cm)	L	Ref.	€	
18	8	2	65338	40,19	-

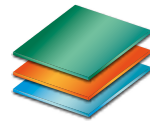

INOX 18/10

GREAT
RELEASEEXCELLENT
DURABILITYMADE WITHOUT
PFOSREGULATORY
COMPLIANTQuantum™ 2
Reinforced non-stick coating**Sartén Style Ecco**

Style Ecco fry pan

Poêle à revêtement anti-adhésif Style Ecco

Antihaftpfanne Style Ecco



Ø (cm)	Fondo contacto Ø (cm)	H (cm)	L	Ref.	€	
20	16	5	1	51421	36,61	8
22	18	5	1,3	51423	39,61	8
24	20	5	1,75	51425	42,19	8
26	22	5	2	51427	48,62	6
28	23,5	5	2,25	51429	53,24	6



INOX 18%

**Pote Ecco Acero sin tapa**

Ecco Acero pot without lid

Gobelet Ecco Acero sans couvercle

Milchtopf Ecco Acero

Ø (cm)	H (cm)	L	Ref.	€	
14	11,5	1,5	64018	28,78	-
16	13	2,5	65218	33,50	-
18	14	3,5	65219	34,65	-



INOX 18/10

**Tapa Ecco Cristal**

Glass lid Ecco

Couvercle verre Ecco

Glasdeckel Ecco



Ø (cm)	Ref.	€	
14	65974	8,81	-
16	65976	8,92	-
18	65978	8,99	-
20	65980	9,15	-
22	65982	9,33	-
24	65984	10,94	-
26	65986	11,36	-
28	65988	12,27	-
30	65990	14,73	-
32	65992	15,46	-

**Tapa Ecco Acero**

Lid Ecco Acero

Couvercle EccoAcero

Deckel Ecco Acero



Ø (cm)	Ref.	€	
14	65814	11,06	-
16	65818	11,44	-
18	65819	11,79	-
20	66818	12,86	-
22	50244	13,52	-
24	51275	15,98	-
26	65027	16,92	-
28	68818	18,03	-
30	68820	22,41	-
32	69818	25,31	-



Kampline



56

ESP Batería de cocina transportable y transformable para disfrutar tanto en el exterior como en el interior. Acero inoxidable de la mejor calidad. Fondo difusor. 7 piezas. Mango sartén desmontable.

Principales características:
Inox · Fondo difusor · Transportable · 7 piezas

ENG A transportable and transformable cooking set to enjoy outdoor and indoor. The best quality of stainless steel. Thermocore base. 7 pieces. Removable fry pan handle.

Main characteristics:
Inox · Thermocore base · Transportable · 7 pieces

FR Une batterie de cuisine portable et transformable pour profiter aussi bien à l'extérieur qu'à l'intérieur. Acier inoxydable de la meilleure qualité. Fond diffuseur. 7 pièces. Manche poêle amovible.

Principales caractéristiques:
Inox · Fond diffuseur · portable · 7 pièces

DE Praktisches Topf-/Pfannenset für drinnen und draußen, auch für die Reise geeignet. Edelstahl erster Güte. Diffusionsboden. 7-teilig. abnehmbarer Griff pfanne.

Hauptmerkmale:
Inox · Diffusionsboden · drinnen · 7-teilig





Kampline

Kampline

Fuego · Fire · Feu · Feuer

O U T D O O R · I N D O O R

“¡Allí donde vayas!”
“Wherever you go!”

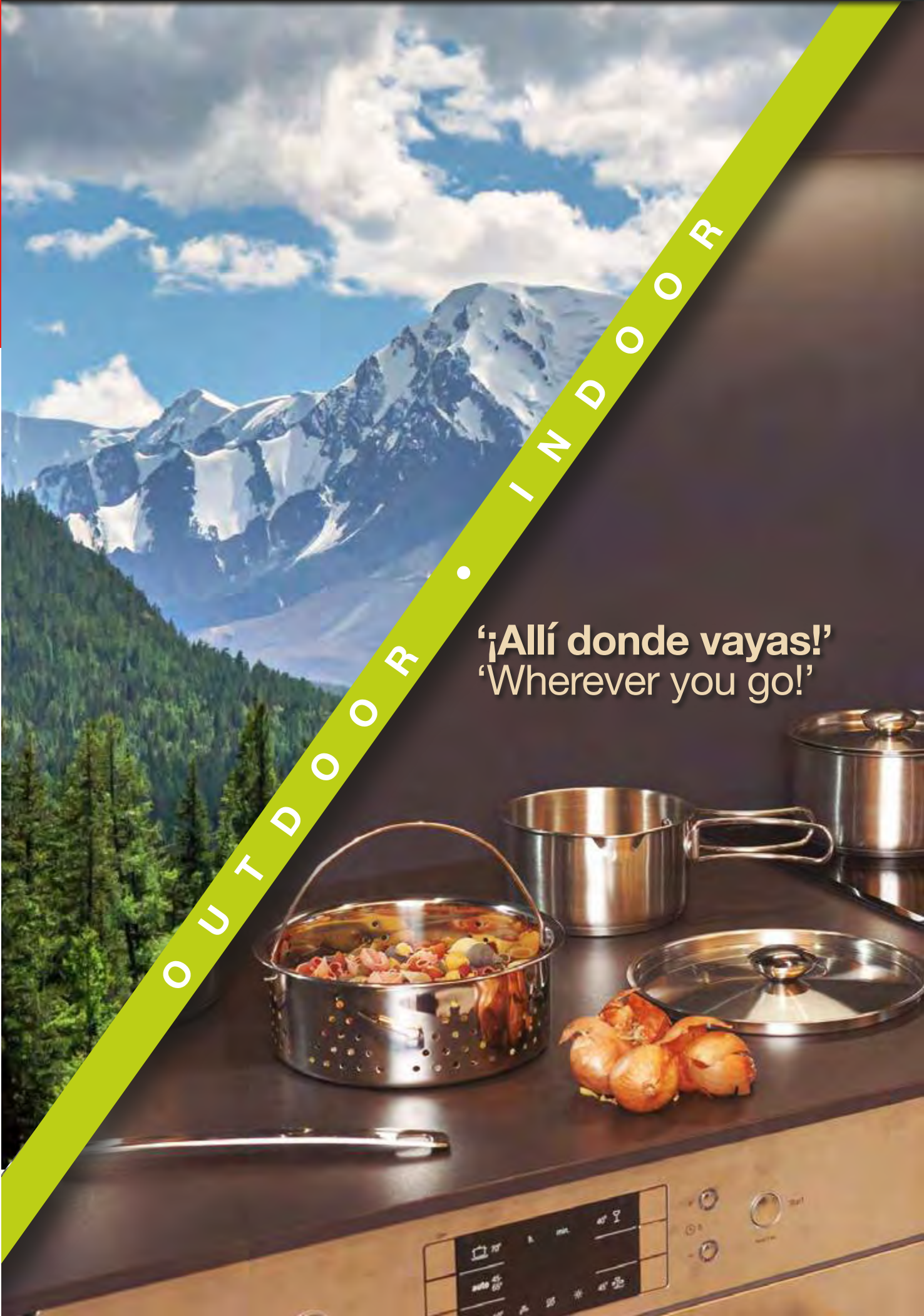

Batería Kamp 7 u

Kamp cooking set 7 P

Batterie Kamp 7 P

Kochgeschirr Kamp 7 P

	Ref.	€	
7 piezas	61117	103,14	



1 Olla · stock pot · Marmite · Fleischtopf Ø 20 cm

1 Cazo · saucepan · Casserole · Stielkasserolle Ø 16 cm

1 Cazo · saucepan · Casserole · Stielkasserolle Ø 14 cm

1 Sartén · Fry pan · Poêle · Pfanne Ø 20 cm

1 Cestillo · Basket · Panier · Korb Ø 18 cm

2 Tapas · Lids · Couvertres · Deckels Ø 16 y 20 cm



+



= 7

Piezas:
Pieces:

Bolsa isotérmica incluida
Included isothermal bag
Sac isotherme incus
Isothermie inklusive Tasche



+



+



+



+



Mango desmontable
Removable handle
Manche amovible
abnehmbarer Griff

‘¿Problemas de espacio?...’
‘Space problems?...’





ESP

Línea fabricada en aluminio fundido indeformable con fondo de acero inoxidable protegido de **6 mm de espesor**. Perfecta para cocinar de forma ligera, usando poco aceite. Ideal para una dieta saludable. Recubrimiento antiadherente Greblon C2 de máxima durabilidad, libre de PFOA. Excelente reparto de la temperatura para una cocción perfecta a la hora de cocinar. Es apta para todas las fuentes de calor. Superficie lisa que se limpia con gran facilidad. Apta para lavavajillas.

Principales características:

Aluminio FUNDIDO · 6 mm de base · Mangos y asas “soft touch”

ENG

Products made of non-deformable cast aluminium with 6 mm thick protected stainless steel bottom. Perfect for light cooking using less oil. Ideal for a healthy diet. PFOA-free, maximum-durability C2 Greblon non-stick coating. Excellent heat distribution properties to ensure your recipes cook perfectly. Suitable for all types of cookers, including induction. Smooth, easy-to-clean surface. Suitable for dishwashers.

Main characteristics:

Cooking set CAST aluminium · 6 mm base · Soft touch handle

FR

Ligne fabriquée en aluminium fondu indéformable avec fond en acier inoxydable protégé de 6 mm d'épaisseur. Idéale pour cuisiner léger, en utilisant peu d'huile. Idéale pour une diète saine. Revêtement antiadhésif Greblon C2 d'une durabilité maximale, sans PFOA. Excellente répartition de la température pour une cuisson parfaite au moment de cuisiner. Apte pour tout type de cuisinières, y compris à induction. Surface lisse qui se nettoie très facilement. Apte pour le lave-vaisselle.

Principales caractéristiques:

Batterie FONTE aluminium · Fond 6 mm épaisseur · Poignée “soft touch”

DE

Serie aus unverformbarem Aluminiumguss mit geschütztem Edelstahlboden mit 6 mm Dicke. Perfekt für die leichte Küche, zum Kochen mit wenig Öl. Ideal für eine gesunde Ernährung. Antihaf-Beschichtung Greblon C2 für maximale Haltbarkeit, frei von PFOA. Hervorragende Temperaturverteilung für perfekte Kochergebnisse. Geeignet für alle Herdtypen, einschließlich Induktio. Glatte, leicht zu reinigende Oberfläche. Spülmaschinenfest.

Hauptmerkmale:

Aluminium GUSS Kochgeschirr · 6 mm boden · Griff “soft touch”



Ollas y cacerolas Orange y Black Absolut
Stock pot and casserole Orange and Black Absolut

(págs. 64 y 65)
(pgs. 64 and 65)





Olla Absolut Orange
Absolut Orange stock pot
Marmite Absolut Orange
Fleischtopf Absolut Orange



Cacerola Absolut Orange
Absolut Orange casserole
Faitout Absolut Orange
Bratentopf Absolut Orange



Cazo Absolut Orange
Absolut Orange saucepan
Casserole Absolut Orange
Stielkasserolle Absolut Orange



Sartén Absolut Orange
Absolut Orange fry pan
Poêle Absolut Orange
Spezial-Antihaftpfanne Absolut Orange



Crepera Absolut Orange
Absolut Orange pancake
Crêpière Absolut Orange
Pancake Absolut Orange

62



Olla Absolut Black
Absolut Black stock pot
Marmite Absolut Black
Fleischtopf Absolut Black



Cacerola Absolut Black
Absolut Black casserole
Faitout Absolut Black
Bratentopf Absolut Black



Cazo Absolut Black
Absolut Black saucepan
Casserole Absolut Black
Stielkasserolle Absolut Black



Sartén Absolut Black
Absolut Black fry pan
Poêle Absolut Black
Spezial-Antihaftpfanne Absolut Black



Crepera Absolut Black
Absolut Black pancake
Crêpière Absolut Black
Pancake Absolut Black



Plancha especial horno
Deep fry pan for oven
Plaque à grill spéciale four
Platte grill spezial ofen



Paellera Absolut Black + 2 manoplas
Absolut Black sauteuse +2 oven gloves
Sauteuse Absolut Black + 2 gants pour le four
Sauteuse Absolut Black + 2 Textilhandschuhe

		Ø (cm)								
		16	18	20	22	24	26	28	30	32
				X		X		X		X
								X		X
		X								
							X			
			X	X	X	X	X	X	X	

Sartenes

Otras piezas · Other components

	Medidas · Sizes		
	24 x 24cm	28 x 28cm	
	34 x 24cm		
	Ø 32cm	Ø 36cm	Ø 40cm
	36 x 23cm	48 x 29cm	

Sartenes



Olla Absolut Orange
Absolut Orange stock pot
Marmite Absolut Orange
Fleischtopf Absolut Orange

Ø (cm)	Fondo contacto (cm)	H (cm)	L	Ref.	€	
20	13,8	9,5	2,2	18140	48,98	4
24	17,5	10,5	3,5	18144	57,56	4
28	20,2	12	6,0	18148	71,11	4
32	21,8	14,5	9,5	18150	85,76	4



Cacerola Absolut Orange
Absolut Orange casserole
Faitout Absolut Orange
Bratentopf Absolut Orange

Ø (cm)	Fondo contacto (cm)	H (cm)	L	Ref.	€	
28	19,2	8	3,5	18154	61,24	4
32	21,8	9	5	18158	79,62	4



Cazo Absolut Orange
Absolut Orange saucepan
Casserole Absolut Orange
Stielkasserolle Absolut Orange

Ø (cm)	Fondo contacto (cm)	H (cm)	L	Ref.	€	
16	12	8	1,2	18116	31,89	6



Crepera Absolut Orange
Absolut Orange pancake
Crêpière Absolut Orange
Pancake Absolut Orange

Ø (cm)	Fondo contacto Ø (cm)	Ref.	€	
26	18	18226	40,75	6



Sartén Absolut Orange
Absolut Orange fry pan
Poêle Absolut Orange
Spezial-Antihaftpfanne Absolut Orange

Ø (cm)	Fondo contacto Ø (cm)	Ref.	€	
18	12,8	18118	32,20	6
20	13,2	18120	34,73	6
22	15,5	18122	37,23	6
24	16,2	18124	39,76	6
26	17,8	18126	45,40	6
28	19	18128	50,45	6
30	20,5	18130	57,02	6





Olla Absolut Black

Absolut Black stock pot
Marmite Absolut Black
Fleischtopf Absolut Black

Ø (cm)	Fondo contacto (cm)	H (cm)	L	Ref.	€	
20	13,8	9,5	2,2	18160	48,98	4
24	17,5	10,5	3,5	18164	57,56	4
28	20,2	12	6,0	18168	71,11	4
32	21,8	14,5	9,5	18169	85,76	4



Cacerola Absolut Black

Absolut Black casserole
Faitout Absolut Black
Bratentopf Absolut Black

Ø (cm)	Fondo contacto (cm)	H (cm)	L	Ref.	€	
28	19,2	8	3,5	18170	61,24	4
32	21,8	9	5	18172	79,62	4



Cazo Absolut Black

Absolut Black saucepan
Casserole Absolut Black
Stielkasserolle Absolut Black

Ø (cm)	Fondo contacto (cm)	H (cm)	L	Ref.	€	
16	12	8	1,2	18117	31,89	6



Crepera Absolut Black

Absolut Black pancake
Crêpière Absolut Black
Pancake Absolut Black

Ø (cm)	Fondo contacto Ø (cm)	Ref.	€	
26	18	18227	40,75	6



Sartén Absolut Black

Absolut Black fry pan
Poêle Absolut Black
Spezial-Antihaftpfanne Absolut Black

Ø (cm)	Fondo contacto Ø (cm)	Ref.	€	
18	12,8	18119	32,20	6
20	13,2	18121	34,73	6
22	15,5	18123	37,23	6
24	16,2	18125	39,76	6
26	17,8	18127	45,40	6
28	19	18129	50,45	6
30	20,5	18131	57,02	6



AbsolutOrangeline



Grill Absolut

(cm)	Fondo contacto Ø (cm)	Ref.	€	
24x24	17,4	18224	47,95	4
28x28	19,5	18228	53,94	6



AbsolutBlackline



Plancha especial horno

Deep fry pan for oven
Plaque à grill spéciale four
Platte grill spezial ofen

x, y (cm)	int (cm)	Ref.	€	
36 x 23	28	18236	71,36	4
48 x 29	38	18246	104,21	4

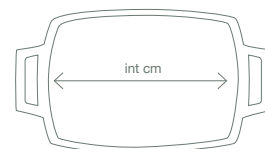

66



FULL INDUCTION

Todo el FONDO DIFUSOR es ACERO INOXIDABLE
ALL the DIFFUSER BOTTOM is STAINLESS STEEL

Acero Inoxidable
Stainless Steel





Grill Absolut

(cm)	Fondo contacto Ø (cm)	Ref.	€	
34 x 24	18,3	18234	62,58	6



Paellera Absolut Black + 2 manoplas

Absolut Black saucepan + 2 oven gloves
 Sauteuse Absolut Black + 2 gants pour le four
 Sauteuse Absolut Black + 2 Textilhandschuhe

Ø pieza (cm)	Ø FONDO (cm)	H (cm)	L	Ref.	€	
32	25,4	4,5	2,5	18132	74,17	4
36	29,2	4,5	3,25	18136	81,53	4
40	31,7	4,5	3,6	18139	96,04	4



Apto para el horno hasta 220 °C (428 °F)
 For use in an oven up to 220 °C (428 °F)
 Est adaoaté aur four jusqu'à 220 °C (428 °F)
 Für eine Hitze bis 220 °C (428 °F) geeignet

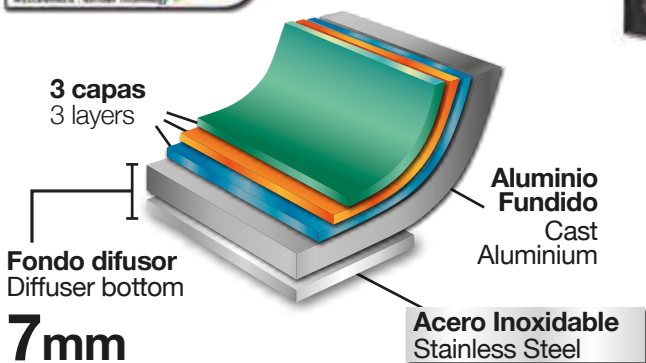

FULL INDUCTION

Todo el FONDO DIFUSOR es ACERO INOXIDABLE
ALL the DIFFUSER BOTTOM is STAINLESS STEEL

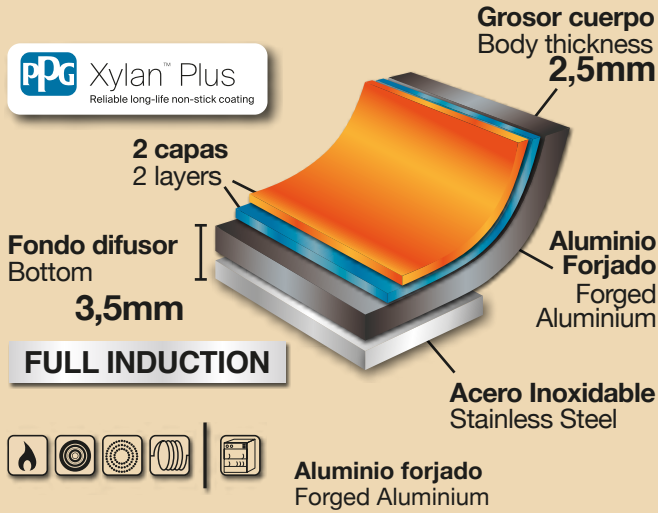

68



- ESP**
- Aluminio forjado con fondo difusor.
 - Apta para todas las fuentes de calor incluida la inducción.
 - Antiadherente Xylan 2 capas, libre de PFOA.
 - Mango tacto suave color negro.
 - Apta para el lavavajillas.

Principales características:

Aluminio FORJADO · Mangos y asas “tacto suave” · FULL INDUCTION

- ENG**
- Forged aluminium with thermocore base.
 - Suitable for all types of cookers, including induction.
 - Environmental-friendly, PFOA-free 2-layer Xylan non-stick coating.
 - Soft touch handle, black color.
 - Suitable for dishwashers.

Main characteristics:

FORGED aluminium · Handles “soft touch” · FULL INDUCTION

- FR**
- Aluminium forgé avec fond diffuseur.
 - apte pour tout type de cuisinières, y compris à induction.
 - Anti-adhésif Xylan 2 couches, sans PFOA.
 - Poignée soft touch couleur noir.
 - Apte pour le lave-vaisselle.

Principales caractéristiques:

Aluminium FORGÉ · Poignées et manches “doux au toucher” · FULL INDUCTION

- DE**
- Aluminium-Bratpfanne.
 - Diffusionsbode.
 - Geeignet für alle Herdtypen, einschließlich Induktio.
 - Antiadherente Xylan 2 capas, libre de PFOA.
 - Soft-Touch-Griff, schwarze Farbe.
 - Spülmaschinenfest.

Hauptmerkmale:

Geschmiedetes Aluminium · Griffe und Handgriffe “soft touch” · FULL INDUCTION

Cacerola y sartén Coal
Coal casserole and frying pan

(pág. 72)
(pg. 72)

Grosor cuerpo
Body thickness
2,5mm



Coalline

Coalline

	Ø (cm)					
	20	22	24	26	28	32
			X		X	
						X
					X	
	X	X	X	X	X	

Sartenes



Cacerola Coal

Coal casserole

Faitout Coal

Bratentopf Coal

Ø (cm)	Fondo contacto Ø (cm)	H (cm)	L	Ref.	€	
24	21	6,5	2,9	18644	47,95	4
28	24	7,5	4,3	18646	56,95	2



Paellera Coal

Coal saucepan

Sauteuse Coal

Sauteuse Coal

Ø (cm)	Fondo contacto Ø (cm)	Ref.	€	
32	25	18632	44,95	4



Wok Coal

Coal wok

Wok Coal

Wok Coal

Ø (cm)	Fondo contacto Ø (cm)	Ref.	€	
28	18,2	18631	32,95	6



Sartén Coal

Coal fry pan

Poêle Coal

Schmiedepfanne Coal

Ø (cm)	Fondo contacto Ø (cm)	Ref.	€	
18	14	18618	20,95	6
20	15,4	18620	22,95	6
22	17,4	18622	24,95	6
24	19,2	18624	27,95	6
26	20,4	18626	30,95	6
28	22,4	18628	34,95	6





72



GREAT DURABILITY



HEALTHFUL COOKING



GREAT RELEASE



EASY CLEAN



MADE WITHOUT PFOS



DISHWASHER SAFE

- ESP**
- Aluminio forjado con fondo difusor.
 - Apta para todas las fuentes de calor incluida la inducción

- Antiadherente Xylan 2 capas, libre de PFOA.
- Mango tacto suave imitación madera.
- Apta para el lavavajillas.

Principales características:

Aluminio FORJADO · Mangos y asas “tacto suave imitación madera”

- ENG**
- Forged aluminium with thermocore base.
 - Suitable for all types of cookers, including induction.
 - Environmental-friendly, PFOA-free 2-layer

- Xylan non-stick coating.
- Soft touch handle, imitation wood.
- Suitable for dishwashers.

Main characteristics:

FORGED aluminium · Handles “soft touch imitation wood”

- FR**
- Aluminium forgé avec fond diffuseur.
 - apte pour tout type de cuisinières, y compris à induction.

- Anti-adhésif Xylan 2 couches, sans PFOA.
- Poignée soft touch, imitation bois.
- Apte pour le lave-vaisselle.

Principales caractéristiques:

Aluminium FORGÉ · Poignées et manches “imitation bois doux au toucher”

- DE**
- Aluminium-Bratpfanne.
 - Diffusionsbode.
 - Geeignet für alle Herdtypen, einschließlich Induktio.

- Antiadherente Xylan 2 capas, libre de PFOA.
- Soft-Touch-Griff, Holzimitation.
- Spülmaschinenfest.

Hauptmerkmale:

Aluminio FORJADO · Griffe und Handgriffe “soft touch imitation wood”

Olla, cacerola y cazo Forêt
Forêt stock pot, casserole and stock saucepan

(pág. 76)
(pg. 76)



Forêtline



Olla Forêt
Forêt stock pot
Marmite Forêt
Fleischtopf Forêt



Cacerola Forêt
Forêt casserole
Faitout Forêt
Bratentopf Forêt



Cazo Forêt
Forêt saucepan
Casserole Forêt
Stielkasserolle Forêt



Sartén Forêt
Forêt fry pan
Poêle Forêt
Schmiedepfanne Forêt



Sartén cuadrada Forêt
Forêt square fry pan
Poêle carrée Forêt
Quadratische bratpfanne Forêt



Wok Forêt
Forêt wok
Wok Forêt
Wok Forêt





Paellera Forêt
Forêt sauteuse
Sauteuse Forêt
Sauteuse Forêt

	Ø (cm)						
	16	18	20	22	24	26	28
	X		X		X		X
					X		X
	X	X					
			X	X	X	X	X
							X

Sartenes

75

Otras piezas · Other components

	Medidas · Sizes	
	24 x 24cm	
	30cm	32cm

Sartenes



Olla Forêt
Forêt stock pot
Marmite Forêt
Fleischtopf Forêt

Ø (cm)	Fondo contacto Ø (cm)	H (cm)	L	Ref.	€	
16	14	8	1,5	18540	31,98	4
20	18	9,5	2,85	18542	39,19	4
24	21	11	4,75	18544	47,99	4
28	24	13	7,74	18546	58,29	2



76



Cacerola Forêt
Forêt casserole
Faitout Forêt
Bratentopf Forêt

Ø (cm)	Fondo contacto Ø (cm)	H (cm)	L	Ref.	€	
24	21	6,5	2,94	18548	44,87	4
28	24	7,5	4,35	18550	54,96	2



Paellera Forêt
Forêt saucepan
Sauteuse Forêt
Sauteuse Forêt

Ø (cm)	Fondo contacto Ø (cm)	Ref.	€	
30	23,8	18530	32,66	6
32	25	18532	41,37	4



Cazo Forêt

Forêt saucepan
Casserole Forêt
Stielkasserolle Forêt

Ø (cm)	Fondo contacto Ø (cm)	H (cm)	L	Ref.	€	
16	13,5	8	1,5	18547	21,79	6
18	15	9	2,2	18549	27,53	6

**Wok Forêt**

Forêt wok
Wok Forêt
Wok Forêt

Ø (cm)	Fondo contacto Ø (cm)	Ref.	€	
28	18,2	18529	32,34	6

**Sartén Forêt**

Forêt fry pan
Poêle Forêt
Schmiedepfanne Forêt

Ø (cm)	Fondo contacto Ø (cm)	Ref.	€	
20	16,2	18520	22,36	6
22	18,2	18522	24,02	6
24	19,2	18524	25,65	6
26	21,2	18526	28,25	6
28	22,8	18528	30,75	6

**Sartén cuadrada Forêt**

Forêt square fry pan
Poêle carrée Forêt
Quadratische bratpfanne Forêt

Ø (cm)	Fondo contacto Ø (cm)	Ref.	€	
24x24	18,2	18531	36,50	6



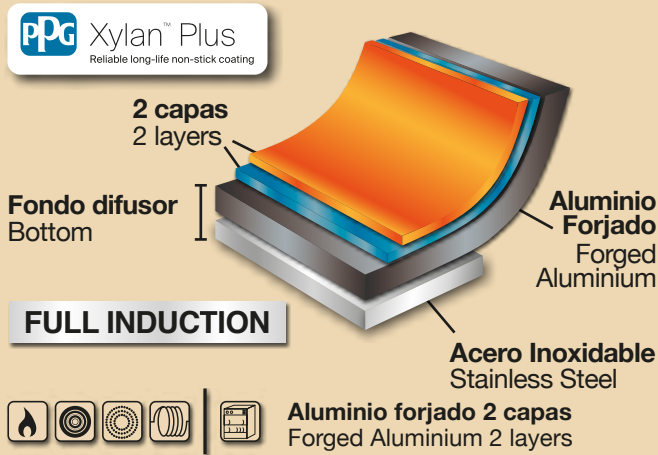

78



ESP Piezas en aluminio forjado con fondo difusor. Apta para todas las fuentes de calor incluida la inducción. Antiadherente Xylan 2 capas, libre de PFOA. Mango tacto suave color naranja. Apta para el lavavajillas.

Principales características:

Aluminio FORJADO · Fondo difusor · Mangos y asas “soft touch”

ENG Forged aluminium with thermocore base, suitable for all types of cookers, including induction. 2-layer Xylan non-stick, PFOA-free coating. Suitable for dishwashers.

Main characteristics:

Forged aluminium with thermocore base · Soft touch handle

FR Aluminium forgé. Fond diffuseur, apte pour tout type de cuisinières, y compris à induction. Anti-adhésif Xylan 2 couches, sans PFOA. Apte pour le lave-vaisselle.

Principales caractéristiques:

Aluminium forgé · Fond diffuseur · Poignée “soft touch”

DE Aluminium-Bratpfanne. Antiadherente Xylan 2 capas, libre de PFOA. Diffusionsbode, Geeignet für alle Herdtypen, einschließlich Induktio. Spülmaschinenfest.

Hauptmerkmale:

Aluminium-Bratpfanne · Griff “soft touch”



Windline



Cacerola Wind
Wind casserole
Faitout Wind
Bratentopf Wind

Ø (cm)	Fondo contacto Ø (cm)	Ref.	€	
26	22	18446	43,75	6
28	23	18448	46,86	6



Set Wind cacerolas 26 + 28 cm
Set Wind casserole 26 + 28 cm
Set Wind faitout 26 + 28 cm
Set Wind Bratentopf 26 + 28 cm

Ø (cm)	Fondo contacto Ø (cm)	Ref.	€
26 + 28	22 & 23	18450	93,30





Sartén Wind

Wind fry pan
Poêle Wind
Pfanne Wind

Ø (cm)	Fondo contacto Ø (cm)	Ref.	€	
18	13,1	18418	17,94	6
20	15,8	18420	21,32	6
22	17,5	18422	22,44	6
24	19,1	18424	23,57	6
26	21	18426	25,81	6
28	22,5	18428	28,07	6



Mango tacto suave
Soft touch handle



Set Wind

Ø (cm)	Ref.	€	
20 + 24	18433	43,82	6



Ø 20 cm

+



Ø 24 cm

81

Plancha Wind de asar

Wind deep fry pan
Plaque à grill Wind
Platte grill Wind

x, y (cm)	Fondo contacto Ø (cm)	int (cm)	Ref.	€	
36 x 22,5	18,5	29	18437	40,44	6
47 x 29	22	37,5	18447	56,19	6

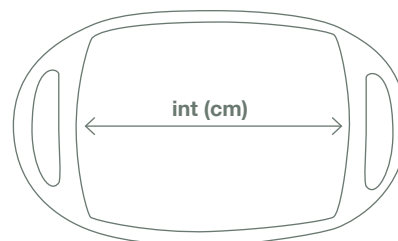

Asas desmontables de silicona
Removable silicone handles

Formaline



INOX 18%

ESP

Debido a la composición del acero, estas piezas requieren menor intensidad de fuego y menor tiempo de cocción. Su ligereza y formato nos ahorran tiempo a la hora de cocinar ya que el calor se transmite de forma rápida y directa a los alimentos.

Principales características:

Inox 18% · Para todos los fuegos · Económica · Asas ergonómicas

ENG

The steel composition means that these cookware items require less heat and cook faster. Their light weight and design save you time when you are cooking because the food absorbs the heat fast and directly.

Main characteristics:

Inox 18% · For all hobs · Economy · Ergonomic handles

FR

En raison de la composition de l'acier, ces pièces requièrent une moindre intensité de feu et un temps de cuisson plus court. Leur légèreté et format nous permettent de gagner du temps lorsque nous cuisinons, vu que la chaleur se transmet rapidement et directement aux aliments.

Principales caractéristiques:

Inox 18% · Compatible tous feux · Économique · Poignées ergonomiques

DE

Diese Töpfe benötigen aufgrund der Zusammensetzung des Stahls geringere Hitze und eine kürzere Garzeit. Leicht, praktisch und zeitsparend dank schneller, direkter Wärmeverteilung.

Hauptmerkmale:

Inox 18% · für alle Herdarten geeignet · Ökonomisch · Ergonomische Griffe



Formaline

Olla forma classic Cristal
Forma classic Cristal stock pot

(pág. 91)
(pg. 91)

Cacerola forma Acero
Forma Acero casserole

(pág. 88)
(pg. 88)



Formaline



Olla Forma Acero
Forma Acero stock
Marmite Forma Acero
Fleischtopf Forma Acero



Cacerola Forma Acero
Forma Acero casserole
Faitout Forma Acero
Bratentopf Forma Acero



Tartera Forma Acero
Forma Acero baking pan
Sauteuse Forma Acero
Pfanne Forma Acero



Olla Forma Classic Acero
Forma Classic Acero stock pot
Marmite Forma Classic Acero
Fleischtopf Forma Classic Acero



Cacerola Forma Classic Acero
Forma Classic Acero casserole
Faitout Forma Classic Acero
Bratentopf Forma Classic Acero



Tartera Forma Classic Acero
Forma Classic Acero baking pan
Sauteuse Forma Classic Acero
Pfanne Forma Classic Acero

84



Pote Forma mango baquelita
Forma pot bakelite handle
Gobelet Forma manche bakélite
Milchtopf Forma Bekelitgriff



vertedor
pouer
verseur
AusgieBtülle



Set 5 cazos (12,14,16,18 y 20)
5-saucepan set (12, 14, 16, 18 and 20)
Set de 5 casseroles (12, 14, 16, 18 et 20)
Satz Stielkasserollen (12, 14, 16, 18 und 20)



Cazo Forma mango baquelita
Forma saucepan bakelite handle
Casserole Forma manche bakélite
Stielkasserolle Forma flach Bakelitgriff

vertedor
pouer
verseur
AusgieBtülle



Cazo Forma mango acerо
Forma steel handle saucepan
Casserole Forma manche acier
Stielkasserolle Forma stahlgriff

vertedor
pouer
verseur
AusgieBtülle





Olla Forma Cristal
Forma Cristal stock pot
Marmite Forma Cristal
Fleischtopf Forma Cristal



Cacerola Forma Cristal
Forma Cristal casserole
Faitout Forma Cristal
Bratentopf Forma Cristal



Tartera Forma Cristal
Forma Cristal baking pan
Sauteuse Forma Cristal
Pfanne Forma Cristal



Olla Forma Classic Acero
Forma Classic Acero stock pot
Marmite Forma Classic Acero
Fleischtopf Forma Classic Acero



Cacerola Forma Classic Acero
Forma Classic Acero casserole
Faitout Forma Classic Acero
Bratentopf Forma Classic Acero



Tartera Forma Classic Acero
Forma Classic Acero baking pan
Sauteuse Forma Classic Acero
Pfanne Forma Classic Acero



Freidora cazo Forma acero con cestillo
Forma steel hande pan with basket
Casserole à friture Forma mancha acier avec panier
Frittierpotf Forma stahlgiff mit Frittiereinsatz



Freidora cazo Forma con cestillo
Forma chip pan with basket
Casserole à friture Forma avec panier
Frittierpotf Forma mit Frittiereinsatz



Sartén antiadherente Forma
Forma fry pan with non-stick surface
Poêle à revêtement anti-adhésif Forma
Spezial-Antihaftpfanne Forma





Sartén Forma Mini
Forma Mini fry pan
Poêle Forma Mini
Pfanne Forma Mini



Antiadherente
non-stick surface
revêtement anti-adhésif
Spezial-Antihaftpfanne

Formaline





Ø (cm)

	8	10	12	14	16	18	20	22	24
				X	X	X	X	X	X
				X	X	X	X	X	X
					X	X	X		X

86

				X	X	X	X	X	X
				X	X	X	X	X	X
					X	X	X		X

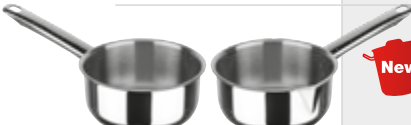
Otras piezas · Other components

 New	X	X	X	X	X	X	X		
		X	X	X	X	X	X		
 New		X	X	X	X	X	X		
			X	X	X	X	X		
	8	10	12	14	16	18	20	22	24

Ø (cm)

	12	14	16	18	20	22	24	26	28
		X	X	X	X	X	X		
		X	X	X	X	X	X		
			X	X	X		X		

		X	X	X	X	X	X		
		X	X	X	X	X	X		
			X	X	X		X		

Otras piezas · Other components

				X					
				X					
		X	X	X	X	X	X		X
		X	X	X	X	X	X		X
	X	X	X						
		X	X						
	12	14	16	18	20	22	24	26	28

Sartenes



Olla Forma Acero
 Forma Acero stock
 Marmite Forma Acero
 Fleischtopf Forma Acero

Ø (cm)	H (cm)	L	Ref.	€	
14	11,5	1,5	60814	29,46	-
16	13	2,5	60816	32,47	-
18	14	3,5	60818	37,57	-
20	14,5	4,5	60820	42,13	-
22	14,8	5,5	60822	46,32	-
24	15	6,5	60824	48,77	-



INOX 18%



Cacerola Forma Acero
 Forma Acero casserole
 Faitout Forma Acero
 Bratentopf Forma Acero

Ø (cm)	H (cm)	L	Ref.	€	
14	7	1	60834	25,81	-
16	7,5	1,5	60836	28,19	-
18	8	2	60838	31,31	-
20	8,5	2,5	60840	35,67	-
22	9	3	60842	40,76	-
24	9,5	4	60844	42,96	-



INOX 18%



Tartera Forma Acero
 Forma Acero baking pan
 Sauteuse Forma Acero
 Pfanne Forma Acero

Ø (cm)	H (cm)	L	Ref.	€	
16	4,7	1	60856	27,45	-
18	5	1,25	60858	29,75	-
20	5,5	1,5	60860	32,44	-
24	6	2,5	60864	40,42	-



INOX 18%



Olla Forma Cristal
 Forma Cristal stock pot
 Marmite Forma Cristal
 Fleischtopf Forma Cristal

Ø (cm)	H (cm)	L	Ref.	€	
14	11,5	1,5	60874	24,45	-
16	13	2,5	60876	26,83	-
18	14	3,5	60878	31,23	-
20	14,5	4,5	60880	35,55	-
22	14,8	5,5	60882	38,76	-
24	15	6,5	60884	40,75	-



INOX 18%



Cacerola Forma Cristal
 Forma Cristal casserole
 Faitout Forma Cristal
 Bratentopf Forma Cristal

Ø (cm)	H (cm)	L	Ref.	€	
14	7	1	60944	20,60	-
16	7,5	1,5	60946	22,35	-
18	8	2	60948	24,74	-
20	8,5	2,5	60950	28,83	-
22	9	3	60952	32,87	-
24	9,5	4	60954	34,60	-



INOX 18%



Tartera Forma Cristal
 Forma Cristal baking pan
 Sauteuse Forma Cristal
 Pfanne Forma Cristal

Ø (cm)	H (cm)	L	Ref.	€	
16	4,7	1	60966	21,81	-
18	5	1,25	60968	23,48	-
20	5,5	1,5	60970	25,64	-
24	6	2,5	60974	32,44	-



INOX 18%





Olla Forma Classic Acero

Forma Classic Acero stock pot
Marmite Forma Classic Acero
Fleischtopf Forma Classic Acero

Ø (cm)	H (cm)	L	Ref.	€	
14	11,5	1,5	60514	29,46	-
16	13	2,5	60516	32,47	-
18	14	3,5	60518	37,57	-
20	14,5	4,5	60520	42,13	-
22	14,8	5,5	60522	46,32	-
24	15	6,5	60524	48,77	-



INOX 18%



Cacerola Forma Classic Acero

Forma Classic Acero casserole
Faitout Forma Classic Acero
Bratentopf Forma Classic Acero

Ø (cm)	H (cm)	L	Ref.	€	
14	7	1	60614	25,81	-
16	7,5	1,5	60616	28,19	-
18	8	2	60618	31,31	-
20	8,5	2,5	60620	35,67	-
22	9	3	60622	40,76	-
24	9,5	4	60624	42,96	-



INOX 18%



Tartera Forma Classic Acero

Forma Classic Acero baking pan
Sauteuse Forma Classic Acero
Pfanne Forma Classic Acero

Ø (cm)	H (cm)	L	Ref.	€	
16	4,7	1	60716	27,45	-
18	5	1,25	60718	29,75	-
20	5,5	1,5	60720	32,14	-
24	6	2,5	60724	40,42	-



INOX 18%



Olla Forma Classic Cristal

Forma Classic Cristal stock pot
Marmite Forma Classic Cristal
Fleischtopf Forma Classic Cristal

Ø (cm)	H (cm)	L	Ref.	€	
14	11,5	1,5	60544	24,45	-
16	13	2,5	60546	26,83	-
18	14	3,5	60548	31,23	-
20	14,5	4,5	60550	35,55	-
22	14,8	5,5	60552	38,76	-
24	15	6,5	60554	40,75	-



INOX 18%

Cacerola Forma Classic Cristal

Forma Classic Cristal casserole
Faitout Forma Classic Cristal
Bratentopf Forma Classic Cristal

Ø (cm)	H (cm)	L	Ref.	€	
14	7	1	60644	20,80	-
16	7,5	1,5	60646	22,57	-
18	8	2	60648	24,97	-
20	8,5	2,5	60650	29,10	-
22	9	3	60652	33,18	-
24	9,5	4	60654	34,93	-



INOX 18%

Tartera Forma Classic Cristal

Forma Classic Cristal baking pan
Sauteuse Forma Classic Cristal
Pfanne Forma Classic Cristal

Ø (cm)	H (cm)	L	Ref.	€	
16	4,7	1	60746	21,81	-
18	5	1,25	60748	23,48	-
20	5,5	1,5	60750	25,64	-
24	6	2,5	60754	32,44	-



INOX 18%



Cazo Forma mango baquelita
 Forma saucepan bakelite handle
 Casserole Forma manche bakélite
 Stielkasserolle Forma flach Bakelitgriff

Ø (cm)	H (cm)	L	Ref.	€	
10	6	0,33	60100	9,78	12
12	6,5	0,5	60102	10,48	12
14	7	1	60104	12,47	12
16	7,5	1,50	60106	13,89	12
18	8	2	60108	15,65	18
20	8	2,5	60110	17,56	18



INOX 18%



Cazo Forma mango acero
 Forma steel handle saucepan
 Casserole Forma manche acier
 Stielkasserolle Forma stahlgiff

Ø (cm)	H (cm)	L	Ref.	€	
10	6	0,33	60400	9,78	12
12	6,5	0,5	60402	10,48	12
14	7	1	60404	12,47	12
16	7,5	1,50	60406	13,89	12
18	8	2	60408	15,65	18
20	8	2,5	60410	17,56	18



INOX 18%



Pote Forma mango baquelita
 Forma pot bakelite handle
 Gobelet Forma manche bakélite
 Milchtopf Forma Bekelitgriff

Ø (cm)	H (cm)	L	Ref.	€	
8	8	0,50	60198	10,06	20
10	10	0,75	60200	10,47	18
12	10	1	60202	12,47	10
14	11	1,50	60204	14,54	10
16	12	2	60206	17,53	12
18	13	2,50	60208	21,01	10
20	15	3,50	60210	24,84	8



INOX 18%



Set 5 cazos (12,14,16,18 y 20)
 5-saucepan set (12,14,16,18 and 20)
 Set de 5 casseroles (12,14,16,18 et 20)
 Satz Stielkasserollen (12,14,16,18 und 20)

Ref.	€	
60041	70,57	



INOX 18%

**Cazo vertedor Forma**

Forma saucepan pourer
Casserole dbec verseur Forma
Stielkasserole AusgieBtülle Forma

Ø (cm)	H (cm)	L	Ref.	€	
12	6,5	0,5	60191	11,01	12
14	7	1	60193	13,08	12
16	7,5	1,50	60195	14,58	12
18	8	2	60197	16,42	18
20	8	2,5	60199	18,42	18



INOX 18%

Vertedor
Pourer

**Cazo vertedor Forma mango acero**

Forma steel handle saucepan pourer
Casserole verseur Forma manche acier
Stielkasserolle AusgieBtülle Forma stahlgriff



Ø (cm)	H (cm)	L	Ref.	€	
12	6,5	0,5	60072	11,01	12
14	7	1	60074	13,08	12
16	7,5	1,50	60076	14,58	12
18	8	2	60078	16,42	18
20	8	2,5	60080	18,42	18



INOX 18%

Vertedor
Pourer



93

Pote vertedor Forma mango baquelita

Forma pot pourer bakelite handle
Gobelet verseur Forma manche bakélite
Milchtopf AusgieBtülle Forma Bekelitgriff



Ø (cm)	H (cm)	L	Ref.	€	
12	10	1	60246	13,10	10
14	11	1,50	60248	15,26	10
16	12	2	60250	18,40	12
18	13	2,50	60251	22,06	10
20	15	3,50	60252	26,08	8



INOX 18%

Vertedor
Pourer

**Cazo Spot pulido mate**

Spot saucepan matt-polished
Casserole Spot poli mat
Stielkasserolle Spot matt poliert



Ø (cm)	H (cm)	L	Ref.	€	
10	6	0,33	60051	3,69	-
12	6,5	0,5	60052	3,81	-
14	7	1	60053	4,19	-
16	7,5	1,25	60054	4,73	-



INOX 18%





Sartén Forma

Forma fry pan
Poêle Forma
Pfanne Forma

Ø (cm)	H (cm)	L	Ref.	€	
14	3	0,3	60148	11,81	-
16	3,8	0,5	60158	12,50	-
18	4,4	0,8	60160	13,69	-
20	5,0	1	60162	15,92	-
22	5,0	1,30	60163	21,21	-
24	5,0	1,75	60164	23,48	-
28	5,0	2,25	60168	30,23	-



INOX 18%



Sartén Forma Mini

Forma Mini fry pan
Poêle Forma Mini
Pfanne Forma Mini



Ø (cm)	H (cm)	L	Ref.	€	
12	3	0,2	60142	11,60	-
14	3	0,3	60144	11,93	-
16	3,8	0,5	60146	12,62	-



INOX 18%



Sartén antiadherente Forma

Forma fry pan with non-stick surface
Poêle à revêtement anti-adhésif Forma
Spezial-Antihaftpfanne Forma

Ø (cm)	H (cm)	L	Ref.	€	
14	3	0,3	60314	16,87	-
16	3,8	0,5	60316	18,90	-
18	4,4	0,8	60318	21,14	-
20	5,0	1	60320	23,69	-
22	5,0	1,30	60322	28,43	-
24	5,0	1,75	60324	31,74	-
28	5,0	2,25	60328	39,59	-



INOX 18%

Sartén Forma Mini Antiadherente

Forma Mini fry pan with non-stick surface
Poêle à revêtement anti-adhésif Forma Mini
Spezial-Antihaftpfanne Forma Mini

Ø (cm)	H (cm)	L	Ref.	€	
14	3	0,3	60145	16,87	-
16	3,8	0,5	60147	18,90	-



INOX 18%

PPG Quantum™2
Reinforced non-stick coating



PPG Quantum™2
Reinforced non-stick coating

**Tapa enchufe Forma**

Lid with knob for deep fryers
Couvercle avec bouton pour friteuses
Deckel mit Knauf für Friteuse

Ø (cm)	Ref.	€	
14	60105	8,27	-
16	60107	9,06	-
18	60109	10,57	-
20	60111	11,89	-
22	60113	12,90	-
24	60115	13,41	-

**Tapa cristal Forma**

Glass lid Forma
Couvercle verre Forma
Glasdeckel Forma

Ø (cm)	Ref.	€	
14	65975	7,05	-
16	65977	7,16	-
18	65979	7,62	-
20	65981	8,08	-
22	65983	8,54	-
24	65985	8,80	-





D'Artagnan Set

Ø (cm)	Ref.	€	
20 + 24 y 20	15448	81,31	-

Composición: Sartén antiadherente 20 y 24 cm, Sautex 20, 3 tapas.

Composition: Fry pan with non-stick surface 20 and 24 cm, Sautex 20, 3 lids.

Composition: Poêle à revêtement anti-adhésif 20 et 24 cm, Sautex 20, 3 couvercle verre.

Bestandteile: Spezial-Antihftpfanne 20 und 24 cm, Sautex 20, 3 Glasdeckel.



INOX 18%

PPG Quantum™2
Reinforced non-stick coating



Set Duo

Ø (cm)	Ref.	€	
20 + 24	15447	73,60	-

Composición: Sartén antiadherente 20 y 24 cm, 2 tapas.

Composition: Fry pan with non-stick surface 20 and 24 cm, 2 lids.

Composition: Poêle à revêtement anti-adhésif 20 et 24 cm, 2 couvercle verre.

Bestandteile: Spezial-Antihftpfanne 20 und 24 cm, 2 Glasdeckel.



INOX 18%

PPG Quantum™2
Reinforced non-stick coating



PPG Quantum™2
Reinforced non-stick coating



Porthos Set

Acero · Steel · Acier · Stahl

Ø (cm)	Ref.	€	
16 - 18 - 20	15446	55,91	-

Composición: cazo 16, 18 y 20 cm.

Composition: saucepan 16, 18 y 20 cm.

Composition: casserole 16, 18 y 20 cm.

Bestandteile: kasserolle 16, 18 y 20 cm.



INOX 18%



Porthos Set

Antiadherente · Non-Stick Surface

Anti-Adhésif · Antihaft

Ø (cm)	Ref.	€	
16 - 18 - 20	15444	76,98	-

Composición: cazo antiadherente 16, 18 y 20 cm.

Composition: saucepan with non-stick surface 16, 18 y 20 cm.

Composition: casserole à revêtement anti-adhésif 16, 18 y 20 cm.

Bestandteile: kasserolle spezial-Anti-adhésif 16, 18 y 20 cm.



INOX 18%

PPG Quantum™2
Reinforced non-stick coating



Mango Multiuso Security

Security Multi handle

Poignée Multi-usage Security

Multigriff Security

Ref.	€	
15103	21,60	40



Tapas de plástico

Plastic lids

Couvercles en plastique

Deckel aus Kunststoff

Ø (cm)	Ref.	€	
20	15102	2,90	-
24	15104	3,30	-



Fryerline



Sartén-freidora con mango y cestillo

Fry pan with handle and basket
Poêle à frire avec poignée et panier
Friteuse mit korb und diffusionsboden

Ø (cm)	H (cm)	L	Ref.	€	
20	6	1,5	51200	33,39	8
24	7	2,5	51291	39,66	6



INOX 18/10



Freidora con cestillo

Deep fryer with basquet
Friteuse avec paniers
Frittierpotf



Ø (cm)	H (cm)	L	Ref.	€	
20	10	2	50180	32,13	10
22	10	3	50280	34,25	8
24	10	4	51280	38,16	10
28	11	6	51308	59,04	4



INOX 18/10



Cestillo suelto para sartén-freidora

Spare basket to pan
Paniers seuls pour poêle à frire
Korb für Fritierpfanne

Ø (cm)	H (cm)	Ref.	€	
20	7	51207	8,00	-
24	7	51297	9,35	-

ACERO NIQUELADO 



Cestillo suelto para freidora

Spare basket to deep fryer
Paniers seuls pour friteuse
Korb für Friteuse

Ø (cm)	H (cm)	Ref.	€	
20	7	50227	7,91	-
22	7	50247	8,03	-
24	7	51277	9,35	-
28	7	51307	12,99	-

ACERO NIQUELADO 





Freidora cazo Forma con cestillo

Forma chip pan with basket
Casserole à friture Forma avec panier
Frittierpotf Forma mit Frittierereinsatz

Ø (cm)	H (cm)	L	Ref.	€	
18	8	2	60118	24,51	12



INOX 18%



Freidora cazo Forma acero con cestillo

Forma steel handle pan with basket
Casserole à friture Forma mancha acier avec panier
Frittierpotf Forma stahlgiff mit Frittierereinsatz

Ø (cm)	H (cm)	L	Ref.	€	
18	8	2	60217	24,51	12



INOX 18%



Freidora cazo Ecco con cestillo

Ecco chip pan with basket
Casserole à friture Ecco avec panier
Frittierpotf Ecco mit Frittierereinsatz

Ø (cm)	H (cm)	L	Ref.	€	
18	8	2	65338	40,19	12



INOX 18/10



Cesta perforada-colador mango varilla

Colander-strainer wire handle
Passoire-égouttoir manche fil
gelochter Korb-Durchschlag Drahtgriff



Ø (cm)	H (cm)	L	Ref.	€	
21	13	4	50215	28,33	6

INOX 18/10 



Freidora cazo Forma con cestillo y vertedero

Forma chip pan with basket and pourer
Casserole à friture Forma avec panier et verseur
Frittierkopf Forma mit Frittiereinsatz und Ausgießtülle



Ø (cm)	H (cm)	L	Ref.	€	
18	8	2	60218	25,28	12



INOX 18%

Freidora cazo Forma acero con cestillo y vertedor

Forma steel handle pan with basket and pourer
Casserole à friture Forma mancha acier avec panier et verseur
Frittierkopf Forma stahlgiff mit Frittiereinsatz und Ausgießtülle



Ø (cm)	H (cm)	L	Ref.	€	
18	8	2	60219	25,28	12



INOX 18%

Cestillo suelto para cazo freidora

Spare basket for chip pan
Panier seul pour bassine à friture
Looser Frittiereinsatz für Frittierkopf

Ø (cm)	H (cm)	Ref.	€	
18	7	51205	8,86	-

ACERO NIQUELADO



Cesta perforada-colador + soporte

Colander-strainer + sup
Panier perforé-passoire + support
gelochter Korb-Durchschlag + Ständer



Ø (cm)	H (cm)	L	Ref.	€	
21	4,5	1,5	50218	9,95	-
21	7,5	2	50217	10,85	-

INOX 18%

* con una sola asa (*)
with a single handle



Cesta perforada-colador
Colander-strainer
Passoire-égouttoir
gelochter Korb-Durchschlag



Ø (cm)	H (cm)	Ref.	€	
21	13	50211	21,15	10

INOX 18/10





Olla-cocedor pasta y verdura

Pasta and vegetable pot - boiler
Marmite - cuiseur pâtes et légumes
Kochtopf - hoher Topf für Nudeln und Gemüse

Ø (cm)	H (cm)	L	Ref.	€	
22	14,8	5,5	67024	64,12	-
24	15	6,5	67026	69,06	-



INOX 18/10



Cacerola-cocedor pasta y verdura

Pasta and vegetable casserole dish - boiler
Braising - cuiseur pâtes et légumes
Kochtopf - hoher Topf für Nudeln und Gemüse

Ø (cm)	H (cm)	L	Ref.	€	
22	9	3	67022	57,72	-



INOX 18/10



Adaptador inducción - vitrocerámica
 Induction - vitroceramic adapter
 Adaptateur induction - vitrocéramique
 Adapter induktion - vitroceramic

Ø (cm)	Ref.	€	
18	51600	20,73	-
23	51601	26,85	-



INOX 18%



NO utilizar sin recipiente encima.
 DO NOT use without a vessel on top.
 NE PAS utiliser sans récipient dessus.
 NICHT ohne Gefäß verwenden



¡Ideal para tus recetas preparadas en cazuelas de barro!
 Ideal for your recipes prepared in clay pots!



Tapas enchufe Forma

Forma lid with knob for deep fryers
Couvercle avec bouton pour friteuses Forma
Deckel mit Knauf für Friteuse Forma

Ø (cm)	Ref.	€	
14	60105	8,27	-
16	60107	9,06	-
18	60109	10,57	-
20	60111	11,89	-
22	60113	12,90	-
24	60115	13,41	-

INOX 18% 



Tapas con pomo para freidora

Lid with knob for deep fryers
Couvercle avec bouton pour friteuses
Deckel mit Knauf für Friteuse

Acero · Steel · Acier · Stahl

Ø (cm)	Ref.	€	
20	66818	12,86	-
22	50244	13,52	-
24	51275	15,98	-
28	68818	18,03	-

INOX 18/10 



Tapas con pomo para freidora

Lid with knob for deep fryers
Couvercle avec bouton pour friteuses
Deckel mit Knauf für Friteuse

Baquelita · Baquelite · Bakélite · Bakelit

Ø (cm)	Ref.	€	
20	50248	13,22	-
22	50249	13,65	-
24	51274	16,28	-
28	51276	18,36	-

INOX 18% 



Tapas universal

Universal lid
Couvercle universel
Universeller Deckel

Ø (cm)	Ref.	€	
26 - 28 - 30	51428	17,47	-

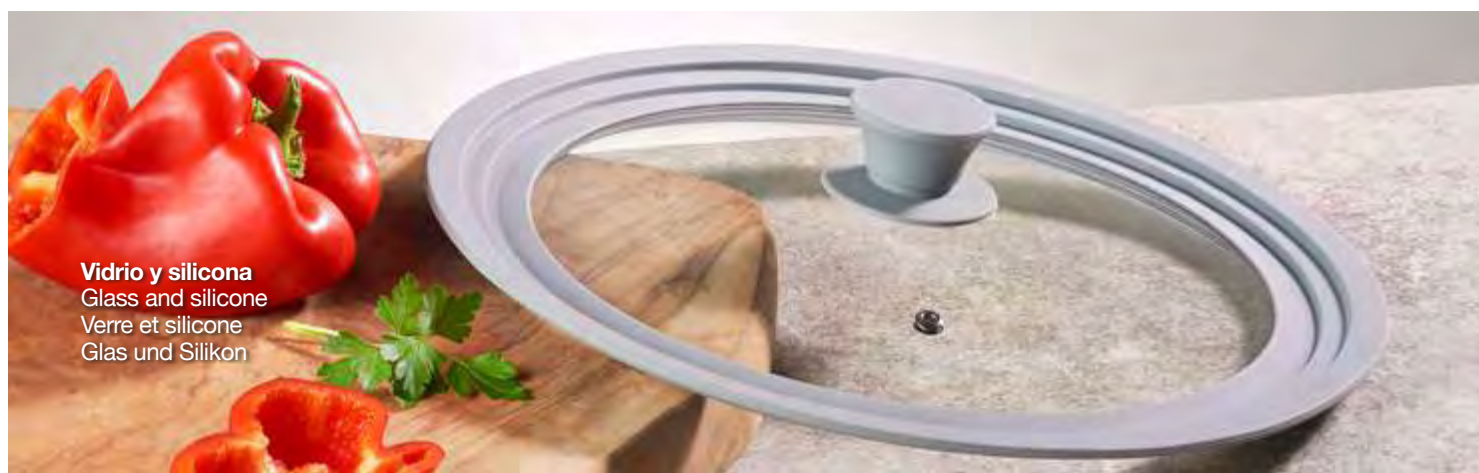

Vidrio y silicona
Glass and silicone
Verre et silicone
Glas und Silikon

Tapa malla
Mesh lid
Maille couvercle
Mesh deckel



Ø (cm) (valido para)	Ref.	€	
20 (16-18-20)	51520	8,43	-
25 (20-22-25)	51525	9,40	-
31(26-28-31)	51531	13,77	-

INOX 

Tapa multiusos
Multipurpose lid
Couvercle multi-usages
Mehrzweckdeckel



Ø (cm) (valido para)	Ref.	€	
20 (16-18-20)	51420	4,11	40
22 (18-20-22)	51422	5,11	40
* 26 (22-24-26)	51426	5,79	40
* 30 (26-28-30)	51430	8,14	30
36 (32-34-36)	51436	12,08	30
42 (38-40-42)	51442	15,91	30
50 (44-46-50)	51450	22,07	-

*

*

INOX 



26, 30cm con agujeros extras

26, 30cm with extra holes

26, 30cm avec trous supplémentaires

26, 30cm mit zusätzlichen Löchern

*





Tapa volteadora de tortilla
 Omelette turn-over lid
 Couvercle retourne-omelette
 Omelett-Wendedeckel



Ø (cm)	Ref.	€	
26	51406	10,74	10
30	51410	11,65	12

INOX 18% 

Pomo con cabeza plana,
 para apoyar sobre la mesa
 Flat head knob,
 to use as a serving stand



Tapa volteadora de tortilla
 Omelette turn-over lid
 Couvercle retourne-omelette
 Omelett-Wendedeckel

Fuego

Fire

Feu

Feuer

Sartenes · Frypan · Poêle · Pfanne



Sartenes, paelleras y planchas...

Fry pans, paelleras and deep fry pans...

Poêles, paelleras et plaques...

Pfanne, paelleras und platte grill...

Sartenes Woks & Creperasline

Fuego · Fire · Feu · Feuer

Sartenes
Frypan · Poêle · Pfanne

108

		Ø (cm)									
		18	20	22	24	26	28	30	32	36	40
Professionaline	INOX 21%	X	X	X	X	X	X				
									X	X	X
		X	X	X	X	X	X				
									X	X	X
TRline	3-ply		X		X		X				
		X	X	X	X	X	X	X	X		
Inoxtoneline			X		X		X				
			X	X	X	X	X				
PROtubeLine			X		X		X		X	X	
		X	X	X	X	X	X	X	X		
Skyline	INOX 18%	X	X	X	X	X	X	X	X		
			X	X	X	X	X				
Eccoline			X	X	X	X	X				
		X	X	X	X	X	X				
Styleline			X	X	X		X				
		X	X	X	X	X	X				
Sualine			X	X	X		X				
		X	X	X	X	X	X				
Absolutline	Aluminio fundido	X	X	X	X	X	X	X			
			X		X		X		X		
Kooperline	Aluminio forjado	X	X	X	X	X	X				
		X	X	X	X	X	X				
Coalline	Aluminio forjado	X	X	X	X	X	X				
		X	X	X	X	X	X				

Sartenes · Frypan · Poêle · Pfanne



Sartenes

Frypan · Poêle · Pflanne

		Ø (cm)								
		12	14	16	18	20	22	24	26	28
	Forêtline					X	X	X	X	X
	Forestline					X		X		X
	Aluminio forjado							X	X	
	Forêtline							X		
	Windline				X	X	X	X	X	X
	Formaline		X	X	X	X	X	X		X
	INOX 18%		X	X	X	X	X	X		X
	INOX 18%	X	X	X						
	INOX 18%		X	X						
		12	14	16	18	20	22	24	26	28

Wok

		Ø (cm)	
		28	30
	Professionaline		X
	INOX 21%		X
	Forêtline	X	
	Aluminio forjado	X	
		28	30

Crepera

Pancake
Crêpière
Pancake

		(cm)
	Absolutline	26
	Aluminio fundido	X
	Aluminio fundido	X









Grill

		(cm)	
	Absolutline	24x24	34x24
	Aluminio fundido	28x28	

Paelleras, planchas & Grilline

Fuego · Fire · Feu · Feuer

Sartenes
Frypan · Poêle · Pfanne

		(cm)							
		20	24	26	28	30	32	36	40
	Professionaline INOX 21%						X	X	X
							X	X	X
	Inoxtoneine INOX 18%		X	X	X		X	X	
		X	X	X	X		X	X	
	Skyline INOX				X		X	X	
	Styleline		X	X	X		X	X	
	Absolutine Aluminio fundido						X	X	X
	Coalline						X		
	Aluminio forjado Forelline					X	X		
		24	26	28	30	32	36	40	

Paelleras · Paella pan · Poêle à Paella · Paella-Pfanne



Plancha

Deep fry pan
Plaque à grill
Platte grill





3 capas
3 layers

Fondo encapsulado
Thermocore base

Acero Inoxidable
Stainless Steel

Aluminio
Aluminium

Acero
Inoxidable
Stainless
Steel

FULL INDUCTION



Acero Inoxidable 21%
Stainless Steel 21%



SPECIAL
FOR
PROFESSIONAL

112



OVEN SAFE
500°F | 260



EXCELLENT
DURABILITY



MADE WITHOUT
PFOS



REGULATORY
COMPLIANT



HEALTHFUL
COOKING



EASY CLEAN

ESP

- **Acero inoxidable 21%**, ideal para cocinar como un chef.
- Recubrimiento antiadherente Platinum 3 capas de máxima durabilidad, **libre de PFOA**, preservando el Medio Ambiente.
- **Fondo encapsulado** hace que se transmita el calor por toda la superficie de forma homogénea.

• **Mango acero.**

- Es apta para todas las fuentes de calor (incluida la inducción) gracias a su fondo difusor **FULL INDUCTION**.
- Apta para lavavajillas.
- Máxima garantía en cuanto a **resistencia, durabilidad e higiene**.

ENG

- **21% stainless steel**, ideal for cooking like a chef.
- Environmental-friendly, **PFOA-free** maximum-durability 3-layer Platinum non-stick coating.
- The diffuser bottom ensures that heat is distributed evenly.

• **Steel handle.**

- Suitable for all types of cookers, including induction.
- Suitable for dishwashers.
- Fully guaranteed in terms of resistance, durability and hygiene.

FR

- Acier inoxydable 21 %, idéal pour cuisiner comme un chef.
- Revêtement antiadhésif Platinum 3 couches d'une très grande durabilité, sans PFOA, préservant l'Environnement.
- Son fond diffuseur lui permet de transmettre la chaleur sur toute la surface de façon homogène.

• Manche en acier.

- Apte pour tout type de cuisinière, y compris à induction.
- Apte pour le lave-vaisselle.
- Maximum de garantie en matière de résistance, durabilité et hygiène.

DE

- Edelstahl 21%, damit Sie wie ein Chefkoch kochen.
- Platin-Antihafbeschichtung, 3 Schichten, für maximale Haltbarkeit, frei von PFOA, umweltfreundlich.
- Dank des Wärmeverteilerbodens wird die Hitze gleichmäßig an die gesamte Oberfläche übertragen.

• Stahlgriff.

- Geeignet für alle Herdtypen, einschließlich Induktio.
- Spülmaschinenfest.
- Maximale Garantie in Bezug auf Beständigkeit, Haltbarkeit und Hygiene.



Sartén Professional
Professional frying pan

(pág. 110)
(pg. 110)



Professionalline



ESP

Fondo encapsulado
Recubrimiento antiadherente
reforzado

ENG

Thermocore base
Non-stick surface

FR

Fond diffuseur
Revêtement anti-adhésif

DE

Diffusionsboden
Spezial-Antihaftpfanne

Sartén Profesional

Professional frying
Poêle Professional
Pfanne Professional



Ø (cm)	Fondo contacto Ø (cm)	H (cm)	Ref.	€	
18	12	4	65719	31,94	12
20	15	4	65721	37,62	12
22	16	4,5	65742	42,74	10
24	18	4,5	65723	43,43	10
26	19,5	5	65746	49,41	10
28	22	5	65725	59,45	6



INOX 21%

Sartén Profesional con asa reforzada

Professional frying pan with extra handle
Poêle Professional avec pognée robuste
Pfanne Professional robuster griff



Ø (cm)	Fondo contacto Ø (cm)	H (cm)	Ref.	€	
32	26	5,5	65727	77,42	4
36	30	6	65729	100,32	4
40	32,5	6,5	65731	123,84	2



INOX 21%

Paellera cónica Profesional

Professional conical saucepan
Sauteuse conique Professional
Sauteuse konisch Professional



Ø (cm)	Fondo contacto Ø (cm)	H (cm)	L	Ref.	€	
32	26	5	2	70932	85,83	4
36	30	6	2,70	70936	98,72	2
40	32,5	7	3,70	70940	119,53	2



INOX 21%

Wok Profesional



Ø (cm)	Fondo contacto Ø (cm)	H (cm)	Ref.	€	
30	16	8,5	65749	68,81	4



INOX 21%

Tapa Wok
Lid Wok
Couvercle Wok
Deckel Wok



Ø (cm)	Ref.	€	
30	34434	17,55	-





OVEN SAFE
500°F | 260



EXCELLENT
DURABILITY



REGULATORY
COMPLIANT



HEALTHFUL
COOKING



EASY CLEAN

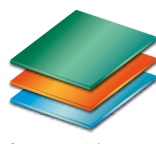

3 capas · 3 layers



PFOA
FREE
100%

Sartén Profesional antiadherente

Professional non-stick surface frying pan

Poêle Professional antiadhésive

Pfanne Professional Antihaft

Ø (cm)	Fondo contacto Ø (cm)	H (cm)	Ref.	€	
18	12	4	65718	37,90	12
20	15	4,5	65720	43,92	12
22	16	5	65722	51,21	10
24	18	5,5	65724	53,93	10
26	19,5	6	65726	61,82	10
28	22	6,5	65728	72,96	6



INOX 21%



Sartén Profesional antiadherente con asa reforzada

Professional non-stick surface frying pan with extra handle

Poêle Professional antiadhésive avec poignée robuste

Pfanne Professional Antihaft robuster griff

Ø (cm)	Fondo contacto Ø (cm)	H (cm)	Ref.	€	
32	26	5,5	65732	94,97	4
36	30	6	65736	120,24	4
40	32,5	6,5	65740	150,67	2



INOX 21%



Paellera cónica antiadherente Profesional

Professional conical saucepan with non-stick surface

Sauteuse conique à revêtement anti-adhésif Professional

Antihaftsauteuse konisch Professional

Ø (cm)	Fondo contacto Ø (cm)	H (cm)	L	Ref.	€	
32	26	5	2	70933	106,24	4
36	30	6	2,70	70937	123,42	2
40	32,5	7	3,70	70941	157,70	2



INOX 21%



Wok antiadherente Profesional

Professional wok with non-stick surface

Wok à revêtement anti-adhésif Professional

Antihaftwok Professional

Ø (cm)	Fondo contacto Ø (cm)	H (cm)	Ref.	€	
30	16	8,5	65750	95,09	4



INOX 21%





2 capas
2 layers

3-ply

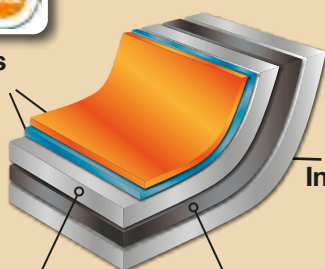

Acero
Inoxidable
Stainless
Steel **18%**

Acero Inoxidable
Stainless Steel **18/10**

Aluminio
Aluminium



ESP

- **Cuerpo 3-ply**, compuesto por 3 capas: Acero inoxidable 18/10, aluminio y acero inoxidable 18%. Ideal para repartir el calor uniformemente.
- Recubrimiento antiadherente **GREBLON Ceramic CK2** de 2 capas de máxima durabilidad, libre de PFOA, GENX, APEO y BPA preservando el Medio Ambiente.

- **Mango soft-touch ergonómico y remachado, de silicona y acero, para un manejo perfecto.**
- Es apta para todas las fuentes de calor (incluida la inducción) **FULL INDUCTION.**
- Apta para lavavajillas.
- Máxima garantía en cuanto a **resistencia, durabilidad e higiene.**

ENG

- 3-ply body, composed of 3 layers: 18/10 stainless steel, aluminum and 18% stainless steel. Ideal for distributing heat evenly.
- GREBLON Ceramic CK2 non-stick coating with 2 layers of maximum durability, free of PFOA, GENX, APEO and BPA, preserving the Environment.

- Ergonomic and riveted soft-touch handle, made of silicone and steel, for perfect handling.
- It is suitable for all heat sources (including induction) **FULL INDUCTION.**
- Dishwasher safe.
- Maximum guarantee in terms of resistance, durability and hygiene.

FR

- Corps 3-ply, composé de 3 couches: inox 18/10, aluminium et 18% inox. Idéal pour répartir uniformément la chaleur.
- Revêtement antiadhésif GREBLON Ceramic CK2 avec 2 couches de durabilité maximale, sans PFOA, GENX, APEO et BPA, préservant l'environnement.

- Poignée soft-touch ergonomique et rivetée, en silicone et acier, pour une prise en main parfaite.
- Il convient à toutes les sources de chaleur (y compris l'induction) **FULL INDUCTION.**
- Apte pour le lave-vaisselle.
- Garantie maximale en termes de résistance, durabilité et hygiène.

DE

- 3-ply Körper, bestehend aus 3 Schichten: Edelstahl 18/10, Aluminium und 18 % Edelstahl. Ideal für eine gleichmäßige Wärmeverteilung.
- GREBLON Ceramic CK2 Antihafbeschichtung mit 2 Schichten von maximaler Haltbarkeit, frei von PFOA, GENX, APEO und BPA, schont die Umwelt.

- Ergonomischer und vernieteter Soft-Touch-Griff aus Silikon und Stahl für perfektes Handling.
- Es ist für alle Herdarten geeignet (auch Induktion) **FULL INDUCTION.**
- Spülmaschinenfest.
- Maximale Garantie in Bezug auf Beständigkeit, Haltbarkeit und Hygiene.



OVEN SAFE
500°F | 260



EXCELLENT
DURABILITY



MADE WITHOUT
PFOA



REGULATORY
COMPLIANT



HEALTHFUL
COOKING



EASY CLEAN

Remaches de 5mm de acero inoxidable

5mm stainless steel rivets

Rivets en acier inoxydable de 5 mm

5mm Edelstahlrieten





Sistema cerámico combinado con silicona, BASE AGUA de 2 capas

Ceramic system combined with silicone,
2-layer WATER-BASED

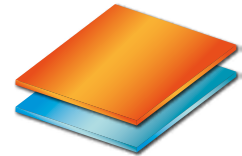

2 capas · 2 layers



Libre 100% de
GenX, PFOA,
APEO, BPA

100% FREE of GenX,
PFOA, APEO, BPA

*Mango soft-touch ergonómico y
remachado, de silicona y acero*
*Ergonomic and riveted soft-touch
handle, silicone and steel*

Remaches de 5mm de acero inoxidable
5mm stainless steel rivets
Rivets en acier inoxydable de 5 mm
5mm Edelstahlnieten



3-ply

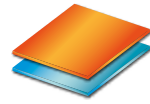

2 capas · 2 layers



Sartén TRline con antiadherente cerámico
 TRline non-stick ceramic surface frying pan
 Poêle TRline céramique antiadhésive
 Pfanne TRline Antihft-Keramikoberfläche



Ø (cm)	Fondo contacto Ø (cm)	H (cm)	Ref.	€	
20	15	4,5	51820	66,10	12
24	18	5,5	51824	78,10	10
28	22	6,5	51828	90,70	6



3-PLY

Disponibles a partir de Julio 2023
 Available from July 2023



Acero Inoxidable 18/10
 Stainless Steel
 Aluminio
 Aluminium
 Acero Inoxidable 18%
 Stainless Steel

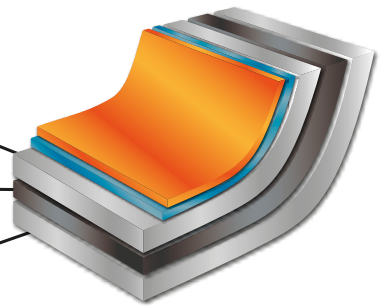

Fuego · Fire · Feu · Feuer

Sartenes
 Frying Pans · Pfanne

119



*‘Alcanzando nuestros sueños’
 ‘Reaching our dreams’*

Imágenes recreadas digitalmente de pruebas internas. No son imágenes representativas del modelo final.
 Digitally recreated images from internal testing. They are not representative images of the final model.

TRline

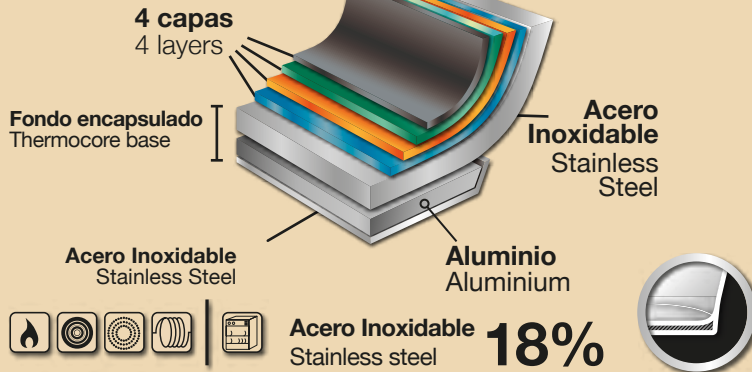

120

- ESP**
- Acero inoxidable 18%, con acabado efecto piedra.
 - Recubrimiento antiadherente Quantanium 4 capas, libre de PFOA, preservando el Medio Ambiente.
 - Su fondo difusor hace que se transmita el calor por toda la superficie de forma homogénea.
 - Apta para todas las fuentes de calor (incluida la inducción) gracias a su fondo difusor **FULL INDUCTION**.
 - Apta para lavavajillas.

FULL INDUCTION



- ENG**
- 18% stainless steel, with stone effect finish.
 - Environmental-friendly, PFOA-free maximum durability 4-layer Quantanium non-stick coating.
 - The diffuser bottom ensures that heat is distributed evenly.
 - Suitable for all types of cookers, including induction.
 - Suitable for dishwashers.

FULL INDUCTION



- FR**
- Acier inoxydable 18%, avec finition effet pierre.
 - Revêtement antiadhésif Quantanium 4 couches d'une très grande durabilité, sans PFOA, préservant l'Environnement.
 - Son fond diffuseur lui permet de transmettre la chaleur sur toute la surface de façon homogène.
 - Apte pour tout type de cuisinière, y compris à induction.
 - Apte pour le lave-vaisselle.



FULL INDUCTION



- DE**
- Edelstahl 18%, Oberfläche in Steinoptik.
 - Quantanium-Antihafbeschichtung, 4 Schichten, für maximale Haltbarkeit, frei von PFOA, umweltfreundlich.
 - Dank des Wärmeverteilerbodens wird die Hitze gleichmäßig an die gesamte Oberfläche übertragen.
 - Geeignet für alle Herdtypen, einschließlich Induktio.
 - Spülmaschinenfest.



FULL INDUCTION



Inoxtone^{line}



Inoxtone

Asa reforzada para:
Extra handle for:
Poignée robuste pour:
Robuster Griff für:

Ø 32 cm

122

Sartén Inoxtone

Inoxtone fry pan
Poêle Inoxtone
Pfanne Inoxtone

Ø (cm)	Fondo contacto Ø (cm)	H (cm)	L	Ref.	€	
18	14	4,4	0,8	51618	37,65	10
20	16	5	1	51620	41,42	8
22	18	5	1,3	51622	44,76	8
24	20	5	1,75	51624	47,72	8
26	22	5	2	51626	54,72	6
28	23,5	5	2,25	51628	59,72	6
32	27	5	3	51632	81,31	1



INOX 18%

Sartén Alta Inoxtone

Inoxtone fry pan high
Poêle Haute Inoxtone
Pfanne Hoog Inoxtone

Ø (cm)	Fondo contacto Ø (cm)	H (cm)	L	Ref.	€	
20	16	6	1,5	51640	43,07	6
24	20	6,5	2,5	51642	49,74	6
28	23,5	7	3,25	51644	63,87	3



INOX 18%

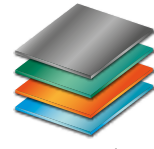

EXCELLENT
RELEASETITANIUM
REINFORCEDMADE WITHOUT
PFOSREGULATORY
COMPLIANT
QuanTanium™
Titanium-reinforced non-stick coating

4 capas · 4 layers

PFA
FREE
100%

Paellera Inoxtone
Inoxtone saucepan
Sauteuse Inoxtone
Sauteuse Inoxtone

Ø (cm)	Fondo contacto Ø (cm)	H (cm)	L	Ref.	€	
20	16	5	1	51220	44,41	3
24	20	5	1,75	51223	49,72	3
26	22	5	2	51225	58,41	4
28	23,5	5	2,25	51228	63,36	4
32	27	5	3	51232	78,97	4
36	28	5	3,75	51236	96,79	3



INOX 18%





Inoxtone Acero

124



Sartén Inoxtone Acero

Inoxtone Acero fry pan

Poêle Inoxtone Acero

Pfanne Inoxtone Acero

Ø (cm)	Fondo contacto Ø (cm)	H (cm)	L	Ref.	€	
20	16	5	1	51621	41,42	8
22	18	5	1,3	51623	44,76	8
24	20	5	1,75	51625	47,72	8
26	22	5	2	51627	54,72	6
28	23,5	5	2,25	51629	59,72	6



INOX 18%

EXCELLENT
RELEASETITANIUM
REINFORCEDMADE WITHOUT
PFOSREGULATORY
COMPLIANT

QuanTanium™
Titanium-reinforced non-stick coating

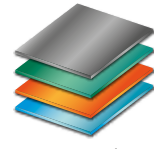

4 capas · 4 layers



125

Paellera Inoxtone Acero

Inoxtone Acero saucepan

Sauteuse Inoxtone Acero

Sauteuse Inoxtone Acero

Ø (cm)	Fondo contacto Ø (cm)	H (cm)	L	Ref.	€	
24	20	5	1,75	51222	56,37	5
26	22	5	2	51227	65,48	6
28	23,5	5	2,25	51229	70,24	6
32	27	5	3	51231	85,15	6
36	28	5	3,75	51235	102,65	5



INOX 18%



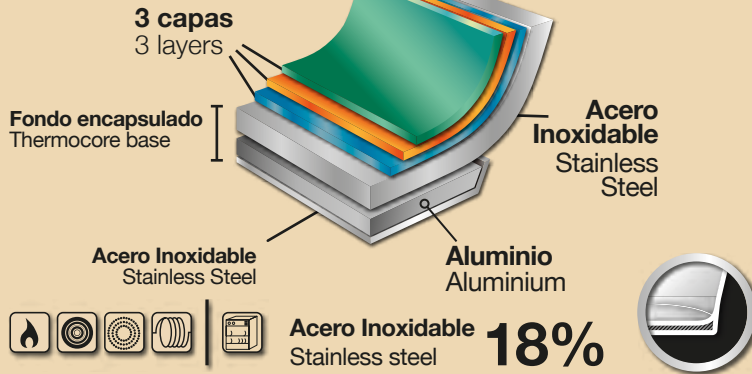

126

ESP

- Acero inoxidable 18%
- Recubrimiento antiadherente Xylan Plus 3 capas, libre de PFOA, preservando el Medio Ambiente.
- Su fondo difusor hace que se transmita el calor por toda la superficie de forma homogénea.

- Mango remachado de acero para profesionales, reforzado y con agujero para evacuar el vapor.
- Apta para todas las fuentes de calor (incluida la inducción) gracias a su fondo difusor **FULL INDUCTION.**
- Apta para lavavajillas.

FULL INDUCTION

ENG

- 18% stainless steel.
- Environmental-friendly, PFOA-free maximum-durability 3-layer Xylan Plus non-stick coating.
- The diffuser bottom ensures that heat is distributed evenly.

- Steel handle with rivets for professionals, reinforced and with steam release orifice.
- Suitable for all types of cookers, including induction.
- Suitable for dishwashers.

FULL INDUCTION

FR

- Acier inoxydable 18%.
- Revêtement antiadhésif Xylan Plus 3 couches d'une très grande durabilité, sans PFOA, préservant l'Environnement.
- Son fond diffuseur lui permet de transmettre la chaleur sur toute la surface de façon

- homogène.
- Manche en acier pour professionnels, renforcé et avec un trou pour évacuer la vapeur.
- Apte pour tout type de cuisinière, y compris à induction.
- Apte pour le lave-vaisselle.

FULL INDUCTION

DE

- Edelstahl 18%.
- Xylan Plus-Antihafbeschichtung, 3 Schichten, für maximale Haltbarkeit, frei von PFOA, umweltfreundlich.
- Dank des Wärmeverteilerbodens wird die Hitze gleichmäßig an die gesamte Oberfläche

- übertragen.
- Speziell für Profis, verstärkt und mit Öffnung zum Dampfabzug.
- Geeignet für alle Herdtypen, einschließlich Induktio.
- Spülmaschinenfest.

FULL INDUCTION



Remaches de 5mm de acero inoxidable

5mm stainless steel rivets

Rivets en acier inoxydable de 5 mm

5mm Edelstahlrieten



127

New

PROtubeline



PROtubeline **New**



Fuego · Fire · Feu · Feuer

Sartenes
Frypan · Poêle · Pfanne



New PROtubeline





GREAT DURABILITY



HEALTHFUL COOKING



GREAT RELEASE



EASY CLEAN



DISHWASHER SAFE



Xylan™ Plus
Reliable long-life non-stick coating

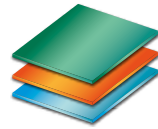

3 capas · 3 layers



Sartén PROtube antiadherente especial

PROtube fry pan with special non-stick surface
Poêle à revêtement anti-adhésif special PROtube
Spezial-Antihaftpfanne PROtube



Ø (cm)	Fondo contacto Ø (cm)	H (cm)	L	Ref.	€	
20	16	5	1	51821	47,13	8
24	20	5	1,75	51825	56,44	8
28	23,5	5	2,25	51829	66,49	6
32	27	5	3	51833	78,98	6
36	28	5	3,75	51837	99,07	5



INOX 18%

Disponibles a partir de Mayo 2023
Available from May 2023

129

Agujero para evacuar
Hole to evacuate
Trou à évacuer
Loch zu evakuieren



Remaches de 5mm de acero inoxidable
5mm stainless steel rivets
Rivets en acier inoxydable de 5 mm
5mm Edelstahlnieten



130



- ESP**
- Acero inoxidable 18%, con acabado efecto plata.
 - Recubrimiento antiadherente Xylan Plus 3 capas, libre de PFOA, preservando el Medio Ambiente.
 - Su fondo difusor hace que se transmita el calor

- por toda la superficie de forma homogénea.
- Apta para todas las fuentes de calor (incluida la inducción) gracias a su fondo difusor **FULL INDUCTION.**
- Apta para lavavajillas.

FULL INDUCTION

- ENG**
- 18% stainless steel, with silver effect finish.
 - Environmental-friendly, PFOA-free maximum-durability 3-layer Xylan Plus non-stick coating.
 - The diffuser bottom ensures that heat is distri-

- buted evenly.
- Suitable for all types of cookers, including induction.
- Suitable for dishwashers.

FULL INDUCTION

- FR**
- Acier inoxydable 18%, avec finition effet pierre.
 - Revêtement antiadhésif Xylan Plus 3 couches d'une très grande durabilité, sans PFOA, préservant l'Environnement.
 - Son fond diffuseur lui permet de transmettre la

- chaleur sur toute la surface de façon homogène.
- Apte pour tout type de cuisinière, y compris à induction.
- Apte pour le lave-vaisselle.

FULL INDUCTION

- DE**
- Edelstahl 18%, mit Silber-Effekt-Finish.
 - Xylan Plus-Antihaftbeschichtung, 3 Schichten, für maximale Haltbarkeit, frei von PFOA, umweltfreundlich.
 - Dank des Wärmeverteilerbodens wird die

- Hitze gleichmäßig an die gesamte Oberfläche übertragen.
- Geeignet für alle Herdtypen, einschließlich Induktio.
- Spülmaschinenfest.

FULL INDUCTION



Skyline



Mango tacto suave, efecto marmol
Soft touch handle 'marble' effect
Manche en bakélite thermo-isolante. Effet marbre.
Wärmeisolierender Bakelitgriff mit
Soft-Touch-Marmoroberfläche





Xylan™ Plus

Reliable long-life non-stick coating

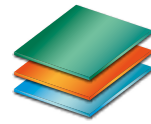

3 capas · 3 layers



Sky



Sartén SKY

SKY fry pan
Poêle SKY
Pfanne SKY

Ø (cm)	Fondo contacto Ø (cm)	H (cm)	L	Ref.	€	
18	14	4,4	0,8	51119	34,76	10
20	16	5	1	51121	38,44	8
22	18	5	1,3	51123	41,58	8
24	20	5	1,75	51125	44,29	8
26	22	5	2	51127	51,06	6
28	23,5	5	2,25	51129	55,91	6



INOX 18%

Paellera SKY

SKY saucepan
Sauteuse SKY
Sauteuse SKY

Ø (cm)	Fondo contacto Ø (cm)	H (cm)	L	Ref.	€	
28	23,5	5	2,25	51028	57,79	4
32	27	5	3	51038	70	4
36	28	5	3,75	51048	81,67	3



INOX 18%



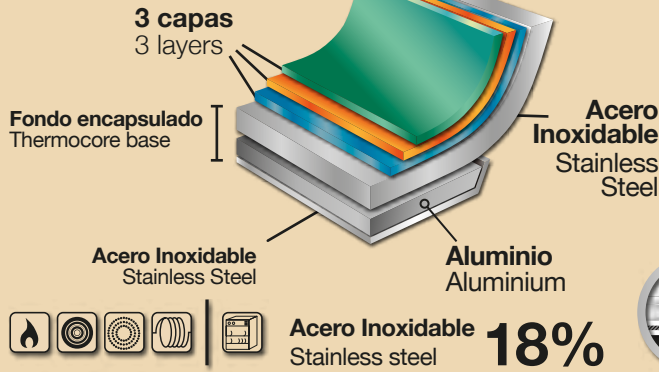

134

- ESP**
- Acero inoxidable 18%
 - Recubrimiento antiadherente Quantum 3 capas, libre de PFOA, preservando el Medio Ambiente.
 - Su fondo difusor hace que se transmita el calor por toda la superficie de forma homogénea.
 - Apta para todas las fuentes de calor (incluida la inducción) gracias a su fondo difusor **FULL INDUCTION**.
 - Apta para lavavajillas.

FULL INDUCTION



- ENG**
- 18% stainless steel.
 - Environmental-friendly, PFOA-free maximum-durability 3-layer Quantum non-stick coating.
 - The diffuser bottom ensures that heat is distributed evenly.
 - Suitable for all types of cookers, including induction.
 - Suitable for dishwashers.

FULL INDUCTION



- FR**
- Acier inoxydable 18%.
 - Revêtement antiadhésif Quantum 3 couches d'une très grande durabilité, sans PFOA, préservant l'Environnement.
 - Son fond diffuseur lui permet de transmettre la chaleur sur toute la surface de façon homogène.
 - Apte pour tout type de cuisinière, y compris à induction.
 - Apte pour le lave-vaisselle.



FULL INDUCTION



- DE**
- Edelstahl 18%.
 - Quantum-Antihaftbeschichtung, 3 Schichten, für maximale Haltbarkeit, frei von PFOA, umweltfreundlich.
 - Dank des Wärmeverteilerbodens wird die Hitze gleichmäßig an die gesamte Oberfläche übertragen.
 - Geeignet für alle Herdtypen, einschließlich Induktio.
 - Spülmaschinenfest.

MADE WITHOUT PFOS



REGULATORY COMPLIANT

FULL INDUCTION



Eccoline

Sin recubrimiento antiadherente
Without non stick coating
Sans revêtement antiadhésif.
Keine Antihftbeschichtung

Todo acero
All Steel
Tout acier
Stahl



Ecco



136



Sartén Ecco

Ecco fry pan
Poêle Ecco
Pfanne Ecco



Ø (cm)	Fondo contacto Ø (cm)	H (cm)	L	Ref.	€	
20	16	5	1	51521	29,47	8
22	18	5	1,3	51523	31,15	8
24	20	5	1,75	51524	32,83	8
26	22	5	2	51527	36,59	6
28	23,5	5	2,25	51529	40,40	6



INOX 18%

INOX 18%



GREAT
RELEASE



EXCELLENT
DURABILITY



MADE WITHOUT
PFOS



REGULATORY
COMPLIANT



Quantum™ 2

Reinforced non-stick coating

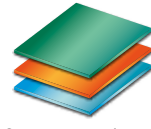

3 capas · 3 layers



137

Sartén Style Ecco

Style Ecco fry pan

Poêle à revêtement anti-adhésif Style Ecco

Antihaftpfanne Style Ecco

Ø (cm)	Fondo contacto Ø (cm)	H (cm)	L	Ref.	€	
20	16	5	1	51421	36,61	8
22	18	5	1,3	51423	39,61	8
24	20	5	1,75	51425	42,19	8
26	22	5	2	51427	48,62	6
28	23,5	5	2,25	51429	53,24	6



INOX 18%

Eccoline

Sartenes
Frypan · Poêle · Pfanne

Fuego · Fire · Feu · Feuer

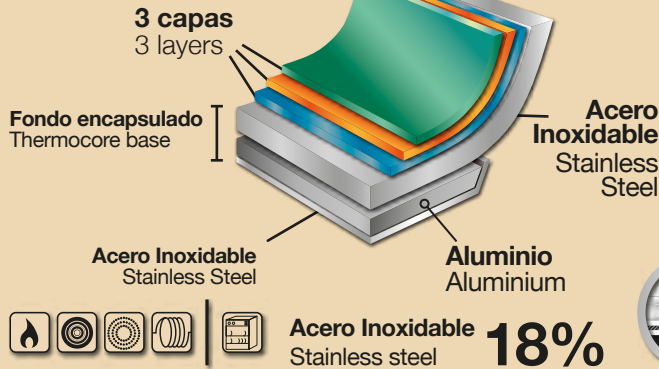

138

ESP

- Acero inoxidable 18%
- Recubrimiento antiadherente Quantum 3 capas, libre de PFOA, preservando el Medio Ambiente.
- Su fondo difusor hace que se transmita el calor por toda la superficie de forma

homogénea.

- Apta para todas las fuentes de calor (incluida la inducción) gracias a su fondo difusor **FULL INDUCTION**.
- Apta para lavavajillas.

FULL INDUCTION



ENG

- 18% stainless steel.
- Environmental-friendly, PFOA-free maximum-durability 3-layer Quantum non-stick coating.
- The diffuser bottom ensures that heat is

distributed evenly.

- Suitable for all types of cookers, including induction.
- Suitable for dishwashers.

FULL INDUCTION



FR

- Acier inoxydable 18%.
- Revêtement antiadhésif Quantum 3 couches d'une très grande durabilité, sans PFOA, préservant l'Environnement.
- Son fond diffuseur lui permet de transmettre la chaleur sur toute la surface de façon

homogène.

- Apte pour tout type de cuisinière, y compris à induction.
- Apte pour le lave-vaisselle.

FULL INDUCTION



DE

- Edelstahl 18%.
- Quantum-Antihaftbeschichtung, 3 Schichten, für maximale Haltbarkeit, frei von PFOA, umweltfreundlich.
- Dank des Wärmeverteilerbodens wird die

Hitze gleichmäßig an die gesamte Oberfläche übertragen.

- Geeignet für alle Herdtypen, einschließlich Induktio.
- Spülmaschinenfest.

FULL INDUCTION



MADE WITHOUT
PFOS



REGULATORY
COMPLIANT



Styleline



Style Inox

140



Sartén Style Inox
Style Inox fry pan
Poêle Style Inox
Pfanne Style Inox

Ø (cm)	Fondo contacto Ø (cm)	H (cm)	L	Ref.	€	
18	14	4,4	0,8	51318	25,73	10
20	16	5	1	51320	29,47	8
22	18	5	1,3	51322	31,15	8
24	20	5	1,75	51324	32,83	8
26	22	5	2	51326	36,59	6
28	23,5	5	2,25	51328	40,40	6

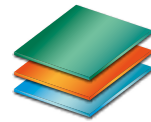

INOX 18%

GREAT
RELEASEEXCELLENT
DURABILITYMADE WITHOUT
PFOSREGULATORY
COMPLIANTQuantum™ 2
Reinforced non-stick coating

3 capas · 3 layers



Style



Sartén Style antiadherente especial

Style fry pan with special non-stick surface
Poêle à revêtement anti-adhésif special Style
Spezial-Antihaftpfanne Style

Ø (cm)	Fondo contacto Ø (cm)	H (cm)	L	Ref.	€	
18	14	4,4	0,8	51319	33,11	10
20	16	5	1	51321	36,61	8
22	18	5	1,3	51323	39,61	8
24	20	5	1,75	51325	42,19	8
26	22	5	2	51327	48,62	6
28	23,5	5	2,25	51329	53,24	6



INOX 18%



Sin recubrimiento antiadherente

Without non stick coating
Sans revêtement antiadhésif.
Keine Antihftbeschichtung

Todo acero

All Steel
Tout acier
Stahl



142



Paellera Style Inox

Style Inox saucepan
Sauteuse Style Inox
Sauteuse Style Inox

Ø (cm)	Fondo contacto Ø (cm)	H (cm)	L	Ref.	€	
24	20	5	1,75	51724	45,12	5
26	22	5	2	51726	51,91	6
28	23,5	5	2,25	51728	54,97	6
32	27	5	3	51732	62,69	6
36	28	5	3,75	51736	74,8	5



INOX 18%



INOX 18%



Sartén Style antiadherente especial
Style fry pan with special non-stick surface
Poêle à revêtement anti-adhésif special Style
Spezial-Antihaftpfanne Style

Molde forma corazón
Baking mould heart
Cercle cœur à moule cuisine
Backform herz



Passión
por la **cocina**

Passion for Cooking
Passion pour la Cuisine
Liebe zur Küche



144



- ESP**
- Aluminio fundido indeformable con fondo de acero inoxidable protegido de 6 mm de espesor.
 - Perfecta para cocinar de forma ligera, usando poco aceite. Ideal para una dieta saludable.
 - Recubrimiento antiadherente Greblon C2 de máxima durabilidad, libre de PFOA.

- Excelente reparto de la temperatura para una cocción perfecta a la hora de cocinar.
- Es apta para todas las fuentes de calor.
- Superficie lisa que se limpia con gran facilidad.
- Apta para lavavajillas.

FULL INDUCTION

- ENG**
- Products made of non-deformable cast aluminium with 6 mm thick protected stainless steel bottom. Perfect for light cooking using less oil. Ideal for a healthy diet. PFOA-free, maximum-durability C2 Greblon non-stick coating.
 - Excellent heat distribution properties to ensure

- your recipes cook perfectly.
- Suitable for all types of cookers, including induction.
- Smooth, easy-to-clean surface. Suitable for dishwashers.

FULL INDUCTION

- FR**
- Ligne fabriquée en aluminium fondu indéformable avec fond en acier inoxydable protégé de 6 mm d'épaisseur. Idéale pour cuisiner léger, en utilisant peu d'huile. Idéale pour une diète saine.
 - Revêtement antiadhésif Greblon C2 d'une durabilité maximale, sans PFOA.

- Excellente répartition de la température pour une cuisson parfaite au moment de cuisiner.
- Apte pour tout type de cuisinières, y compris à induction.
- Surface lisse qui se nettoie très facilement. Apte pour le lave-vaisselle.

FULL INDUCTION

- DE**
- Serie aus unverformbarem Aluminiumguss mit geschütztem Edelstahlboden mit 6 mm Dicke. Perfekt für die leichte Küche, zum Kochen mit wenig Öl. Ideal für eine gesunde Ernährung.
 - Antihaft-Beschichtung Greblon C2 für maximale Haltbarkeit, frei von PFOA.

- Hervorragende Temperaturverteilung für perfekte Kochergebnisse.
- Geeignet für alle Herdtypen, einschließlich Induktion.
- Glatte, leicht zu reinigende Oberfläche. Spülmaschinenfest.

FULL INDUCTION



Absolutline



Absolut Orange



Sartén Absolut Orange
Absolut Orange fry pan
Poêle Absolut Orange
Spezial-Antihaftpfanne Absolut Orange

Ø (cm)	Fondo contacto Ø (cm)	Ref.	€	
18	12,8	18118	32,20	6
20	13,2	18120	34,73	6
22	15,5	18122	37,23	6
24	16,2	18124	39,76	6
26	17,8	18126	45,40	6
28	19	18128	50,45	6
30	20,5	18130	57,02	6



Crepera Absolut Orange
Absolut Orange pancake
Crêpière Absolut Orange
Pancake Absolut Orange

Ø (cm)	Fondo contacto Ø (cm)	Ref.	€	
26	18	18226	40,75	6



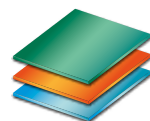

FULL INDUCTION



3 capas · 3 layers

Absolut Black



Sartén Absolut Black

Absolut Black fry pan
Poêle Absolut Black
Spezial-Antihaftpfanne Absolut Black

Ø (cm)	Fondo contacto Ø (cm)	Ref.	€	
18	12,8	18119	32,20	6
20	13,2	18121	34,73	6
22	15,5	18123	37,23	6
24	16,2	18125	39,76	6
26	17,8	18127	45,40	6
28	19	18129	50,45	6
30	20,5	18131	57,02	6



Crepera Absolut Black

Absolut Black pancake
Crêpière Absolut Black
Pancake Absolut Black

Ø (cm)	Fondo contacto Ø (cm)	Ref.	€	
26	18	18227	40,75	6





Grill Absolut

(cm)	Fondo contacto Ø (cm)	Ref.	€	
24x24	17,4	18224	47,95	4
28x28	19,5	18228	53,94	6



AbsolutBlackline



Plancha especial horno

Deep fry pan for oven
Plaque à grill spéciale four
Platte grill spezial ofen

x, y (cm)	int (cm)	Ref.	€	
36 x 23	28	18236	71,36	4
48 x 29	38	18246	104,21	4

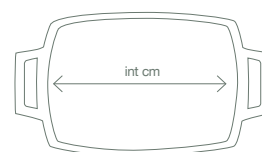

FULL INDUCTION

Todo el FONDO DIFUSOR es ACERO INOXIDABLE
ALL the DIFFUSER BOTTOM is STAINLESS STEEL

Acero Inoxidable
Stainless Steel





Grill Absolut

(cm)	Fondo contacto Ø (cm)	Ref.	€	
34 x 24	18,3	18234	62,58	6



Paellera Absolut Black + 2 manoplas

Absolut Black saucepan + 2 oven gloves

Sauteuse Absolut Black + 2 gants pour le four

Sauteuse Absolut Black + 2 Textilhandschuhe

Ø pieza (cm)	Ø FONDO (cm)	H (cm)	L	Ref.	€	
32	25,4	4,5	2,5	18132	74,17	4
36	29,2	4,5	3,25	18136	81,53	4
40	31,7	4,5	3,6	18139	96,04	4



Apto para el horno hasta 220 °C (428 °F)
 For use in an oven up to 220 °C (428 °F)
 Est adaoaté aur four jusqu'à 220 °C (428 °F)
 Für eine Hitze bis 220 °C (428 °F) geeignet



149

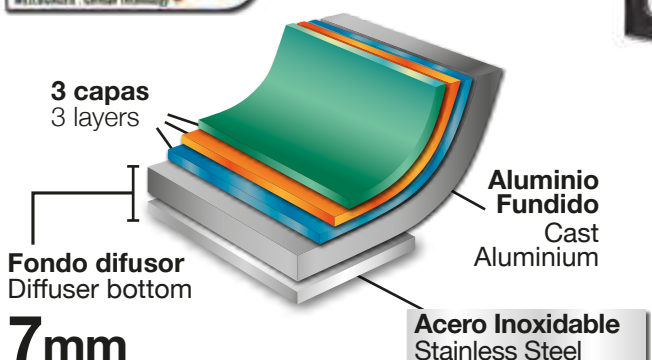

FULL INDUCTION

Todo el FONDO DIFUSOR es ACERO INOXIDABLE
ALL the DIFFUSER BOTTOM is STAINLESS STEEL

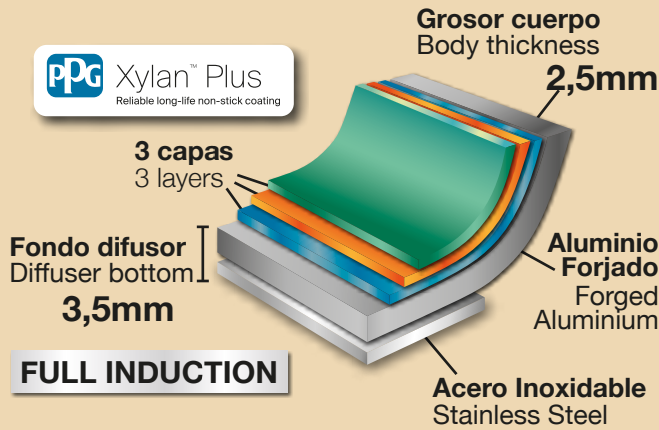

FULL INDUCTION



Aluminio forjado 3 capas
Forged Aluminium 3 layers

150



- ESP**
- Aluminio forjado con recubrimiento exterior efecto cobre.
 - Antiadherente Xylan 3 capas, libre de PFOA.
 - Fondo difusor apto para todo tipo de fuegos, incluida la inducción.
 - Mango de acero para profesionales, reforzado y con agujero para evacuar el vapor.
 - Protector de sartenes de regalo, para apilarlas sin dañar el recubrimiento.
 - Apta para lavavajillas.

FULL INDUCTION



GREAT DURABILITY



HEALTHFUL COOKING



GREAT RELEASE



EASY CLEAN



MADE WITHOUT PFOS



DISHWASHER SAFE

- ENG**
- Forged aluminium frying pan with copper-effect outer coating.
 - 3-layer Xylan non-stick, PFOA-free coating.
 - Thermocore base, suitable for all types of cookers, including induction.
 - Steel handle for professionals, reinforced and with steam release orifice.
 - Free frying pan protector, for stacking them without damaging the coating.
 - Suitable for dishwashers.

FULL INDUCTION

- FR**
- Aluminium forgé avec revêtement extérieur effet cuivre.
 - Anti-adhésif Xylan 3 couches, sans PFOA.
 - Fond diffuseur, apte pour tout type de cuisinières, y compris à induction.
 - Manche en acier pour professionnels, renforcé et avec un trou pour évacuer la vapeur.
 - Protecteur de poêles en cadeau, pour les empiler sans abîmer le revêtement.
 - Apte pour le lave-vaisselle.

FULL INDUCTION

- DE**
- Aluminium-Bratpfanne, geschmiedet, mit kupferfarbener Außenbeschichtung.
 - Xylan-Antihaftbeschichtung, 3 Schichten, für maximale Haltbarkeit, frei von PFOA, umweltfreundlich.
 - Diffusionsbode, Geeignet für alle Herdtypen, einschließlich Induktio.
 - Speziell für Profis, verstärkt und mit Öffnung zum Dampfabzug.
 - Pfannenschutz für Geschenkverpackungen, zum Stapeln ohne Beschädigung der Beschichtung.
 - Spülmaschinenfest.

FULL INDUCTION

Grosor cuerpo
Body thickness
2,5mm



Kooperline

KooperPro



Protector incluido
Protective free

Sartén Kooper Pro
Kooper Pro fry pan
Poêle Kooper Pro
Pfanne Kooper Pro



Ø (cm)	Fondo contacto Ø (cm)	Ref.	€	
20	15,4	18323	27,47	6
24	19,2	18325	33,28	6
28	22,4	18329	39,98	6
32	24,7	18333	52,94	6



152



Set 3 protectores de sartenes

Set of 3 frypan protectors

Set de 3 feuilles protection pour poêles

Pfannenschutz einstellen

Ø (cm)	Ref.	€	
18 - 20 - 22	18315	4,06	-
24 - 26 - 28	18317	4,92	-





PPG Xylan™ Plus
Reliable long-life non-stick coating

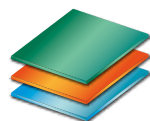

FULL INDUCTION



3 capas • 3 layers

Sartén Kooper Me
Kooper Me fry pan
Poêle Kooper Me
Pfanne Kooper Me



Ø (cm)	Fondo contacto Ø (cm)	Ref.	€	
18	14	18318	23,97	6
20	15,4	18320	26,31	6
22	17,4	18322	28,61	6
24	19,2	18324	30,98	6
26	20,4	18326	34,51	6
28	22,4	18328	38,50	6



KooperMe



Protector incluido
Protective free



Set especial Special set

KooperMe

Ø (cm)	Ref.	€	
24+28	18331	69,84	



Recetas de cocina
Cooking recipes

+ by *David de Jorge*

Ø **24**cm



Protector de sartenes
Frying pan protector



Ø **28**cm



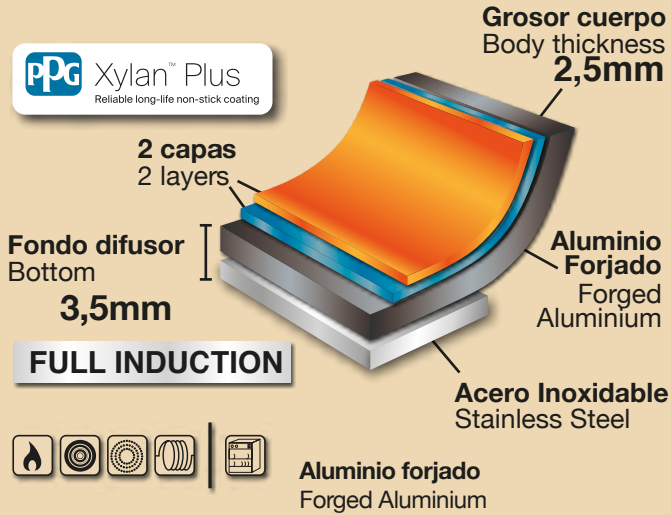

154



- ESP**
- Aluminio forjado con fondo difusor.
 - Apta para todas las fuentes de calor incluida la inducción.
 - Antiadherente Xylan 2 capas, libre de PFOA.
 - Mango tacto suave color negro.
 - Apta para el lavavajillas.

Principales características:

Aluminio FORJADO · Mangos y asas “tacto suave” · FULL INDUCTION



GREAT DURABILITY



HEALTHFUL COOKING



GREAT RELEASE



EASY CLEAN



MADE WITHOUT PFOS



DISHWASHER SAFE

- ENG**
- Forged aluminium with thermocore base.
 - Suitable for all types of cookers, including induction.
 - Environmental-friendly, PFOA-free 2-layer Xylan non-stick coating.
 - Soft touch handle, black color.
 - Suitable for dishwashers.

Main characteristics:

FORGED aluminium · Handles “soft touch” · FULL INDUCTION

- FR**
- Aluminium forgé avec fond diffuseur.
 - apte pour tout type de cuisinières, y compris à induction.
 - Anti-adhésif Xylan 2 couches, sans PFOA.
 - Poignée soft touch couleur noir.
 - Apte pour le lave-vaisselle.

Principales caractéristiques:

Aluminium FORGÉ · Poignées et manches “doux au toucher” · FULL INDUCTION

- DE**
- Aluminium-Bratpfanne.
 - Diffusionsbode.
 - Geeignet für alle Herdtypen, einschließlich Induktio.
 - Antiadherente Xylan 2 capas, libre de PFOA.
 - Soft-Touch-Griff, schwarze Farbe.
 - Spülmaschinenfest.

Hauptmerkmale:

Geschmiedetes Aluminium · Griffe und Handgriffe “soft touch” · FULL INDUCTION

Grosor cuerpo
Body thickness
2,5mm



Coalline



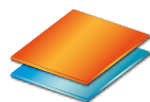

2 capas · 2 layers



Sartén Coal

Coal fry pan
Poêle Coal
Pfanne Coal

Ø (cm)	Fondo contacto Ø (cm)	Ref.	€	
18	14	18618	20,95	6
20	15,4	18620	22,95	6
22	17,4	18622	24,95	6
24	19,2	18624	27,95	6
26	20,4	18626	30,95	6
28	22,4	18628	34,95	6



Wok Coal

Coal wok
Wok Coal
Wok Coal

Ø (cm)	Fondo contacto Ø (cm)	Ref.	€	
28	18,2	18631	32,95	6



Paellera Coal

Coal paella pan
Sauteuse Coal
Sauteuse Coal

Ø (cm)	Fondo contacto Ø (cm)	Ref.	€	
32	25	18632	44,95	4



Forestline & Forêtline

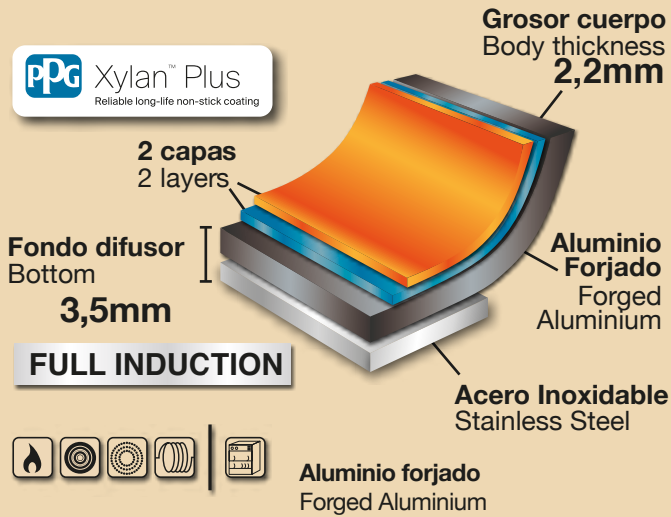

158



- ESP**
- Aluminio forjado con fondo difusor.
 - Apta para todas las fuentes de calor incluida la inducción

- Antiadherente Xylan 2 capas, libre de PFOA.
- Mango tacto suave imitación madera.
- Apta para el lavavajillas.

FULL INDUCTION



GREAT DURABILITY



HEALTHFUL COOKING



GREAT RELEASE



EASY CLEAN



MADE WITHOUT PFOS



DISHWASHER SAFE

- ENG**
- Forged aluminium with thermocore base.
 - Suitable for all types of cookers, including induction.
 - Environmental-friendly, PFOA-free 2-layer

- Xylan non-stick coating.
- Soft touch handle, imitation wood.
- Suitable for dishwashers.

FULL INDUCTION

- FR**
- Aluminium forgé avec fond diffuseur.
 - apte pour tout type de cuisinières, y compris à induction.

- Anti-adhésif Xylan 2 couches, sans PFOA.
- Poignée soft touch, imitation bois.
- Apte pour le lave-vaisselle.

FULL INDUCTION

- DE**
- Aluminium-Bratpfanne.
 - Diffusionsbode.
 - Geeignet für alle Herdtypen, einschließlich Induktio.
 - Xylan-Antihaftbeschichtung, 2 Schichten, für

- maximale Haltbarkeit, frei von PFOA, umweltfreundlich..
- Soft-Touch-Griff, Holzimitation.
- Spülmaschinenfest.

FULL INDUCTION



**Forestline
& Forêtline**



Sartén Forest
Forest fry pan
Poêle Forest
Schmiedepfanne Forest

Ø (cm)	Fondo contacto Ø (cm)	Ref.	€	
20	16,2	18421	22,36	6
24	19,2	18425	25,65	6
28	22,8	18429	30,75	6



Sartén cuadrada Forest
Forest square fry pan
Poêle carrée Forest
Quadratische bratpfanne Forest

Ø (cm)	Fondo contacto Ø (cm)	Ref.	€	
24 x 24	18,2	18430	36,50	6
26 x 26	21	18432	40,05	6





PPG Xylan™ Plus
Reliable long-life non-stick coating

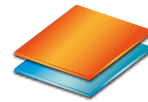

FULL INDUCTION



2 capas · 2 layers

Sartén Forêt

Forêt fry pan
Poêle Forêt
Schmiedepfanne Forêt

Ø (cm)	Fondo contacto Ø (cm)	Ref.	€	
20	16,2	18520	22,36	6
22	18,2	18522	24,02	6
24	19,2	18524	25,65	6
26	21,2	18526	28,25	6
28	22,8	18528	30,75	6



Sartén cuadrada Forêt

Forêt square fry pan
Poêle carrée Forêt
Quadratische bratpfanne Forêt

Ø (cm)	Fondo contacto Ø (cm)	Ref.	€	
24x24	18,2	18531	36,50	6



Paellera Forêt

Forêt saucepan
Sauteuse Forêt
Sauteuse Forêt

Ø (cm)	Fondo contacto Ø (cm)	Ref.	€	
30	23,8	18530	32,66	6
32	25	18532	41,37	4



Sualine

PPG QuantumTM2
Reinforced non-stick coating

2 capas
2 layers

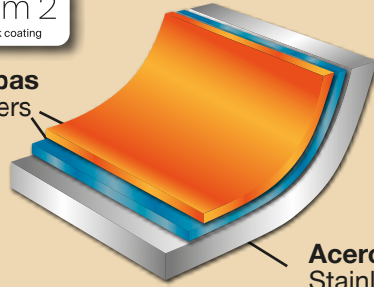

Acero Inoxidable
Stainless Steel



Acero Inoxidable
Stainless steel **18%**

162

- ESP**
- Acero inoxidable 18%.
 - Recubrimiento antiadherente Quantum2, libre de PFOA, preservando el Medio Ambiente.
 - Mango baquelita remachado y termoaislante.
 - Ahorro de energía por la utilización del fuego a baja intensidad.
 - Es apta para todas las fuentes de calor (incluida la inducción).
 - Apta para lavavajillas.



- ENG**
- 18% stainless steel.
 - Environmental-friendly, PFOA-free Quantum2 non-stick coating.
 - Heat-resistant Bakelite handle.
 - Energy saving when used on low heat.
 - Suitable for all heat sources (including induction).
 - Dishwasher safe.



- FR**
- Acier inoxydable 18%.
 - Revêtement antiadhésif Quantum2, sans PFOA, préservant l'Environnement.
 - Manche bakélite thermo-isolant.
 - Économie d'énergie pour l'utilisation du feu à faible intensité.
 - Elle est apte pour toutes les sources de chaleur (y compris l'induction).
 - Lavable au lave-vaisselle.



MADE WITHOUT PFOA



REGULATORY COMPLIANT

- DE**
- Edelstahl 18%.
 - Quantum-Antihafbeschichtung, 3 Schichten, für maximale Haltbarkeit, frei von PFOA, umweltfreundlich.
 - Wärmeisolierter Bakelitstie.
 - Geeignet für alle Herdtypen, einschließlich Induktio.
 - Spülmaschinenfest.

Sartén antiadherente Sualine

Sualine fry pan with non-stick surface
Poêle à revêtement anti-adhésif Sualine
Spezial-Antihaftpfanne Sualine

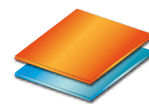

2 capas · 2 layers

Ø (cm)	Fondo contacto Ø (cm)	H (cm)	L	Ref.	€	
18	13	4,4	0,8	51918	25,47	-
20	15,3	5,0	1	51920	27,35	-
22	17,1	5,0	1,30	51922	33,46	-
24	19,1	5,0	1,75	51924	37,22	-
26	21	5,0	2	51926	40,51	-
28	23	5,0	2,25	51928	44,98	-



INOX 18%

Disponibles a partir de Mayo 2023

Available from May 2023



Sartén Sualine INOX

Sualine INOX fry pan
Poêle Sualine INOX
Pfanne Sualine INOX



Ø (cm)	Fondo contacto Ø (cm)	H (cm)	L	Ref.	€	
18	13	4,4	0,8	51919	19,44	-
20	15,3	5,0	1	51921	22,14	-
22	17,1	5,0	1,30	51923	27,09	-
24	19,1	5,0	1,75	51925	29,79	-
26	21	5,0	2	51927	31,14	-
28	23	5,0	2,25	51929	33,61	-



INOX 18%

Disponibles a partir de Mayo 2023

Available from May 2023



163



Remaches de 5mm de acero inoxidable
5mm stainless steel rivets
Rivets en acier inoxydable de 5 mm
5mm Edelstahlnieten

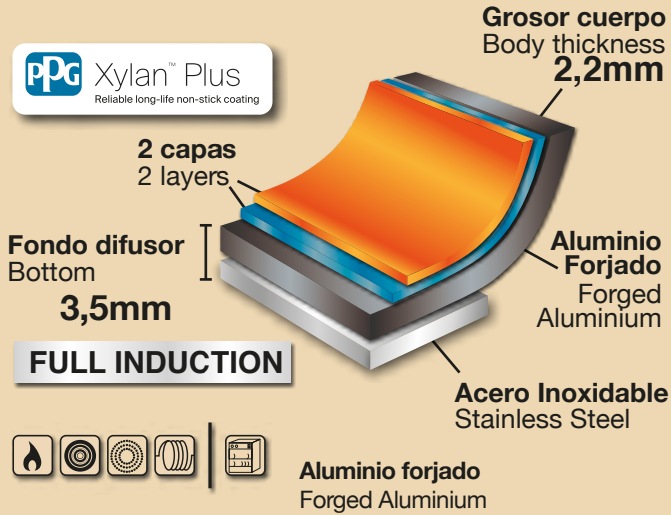

164



- ESP**
- Aluminio forjado con fondo difusor.
 - Apta para todas las fuentes de calor incluida la inducción.
 - Antiadherente Xylan 2 capas, libre de PFOA.
 - Mango tacto suave.
 - Apta para el lavavajillas.

FULL INDUCTION



- ENG**
- Forged aluminium with thermocore base.
 - Suitable for all types of cookers, including induction.
 - Environmental-friendly, PFOA-free 2-layer Xylan non-stick coating.
 - Soft touch handle.
 - Suitable for dishwashers.



FULL INDUCTION



- FR**
- Aluminium forgé avec fond diffuseur.
 - apte pour tout type de cuisinières, y compris à induction.
 - Anti-adhésif Xylan 2 couches, sans PFOA.
 - Poignée soft touch.
 - Apte pour le lave-vaisselle.



FULL INDUCTION



- DE**
- Aluminium-Bratpfanne.
 - Diffusionsbode.
 - Geeignet für alle Herdtypen, einschließlich Induktio.
 - Xylan-Antihaftbeschichtung, 2 Schichten, für maximale Haltbarkeit, frei von PFOA, umweltfreundlich.
 - Soft-Touch-Griff.
 - Spülmaschinenfest.



FULL INDUCTION



PPG Xylan™ Plus
Reliable long-life non-stick coating

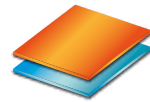

FULL INDUCTION



2 capas · 2 layers

Mango tacto suave
Soft touch handle



Sartén Wind
Wind fry pan
Poêle Wind
Pfanne Wind

Ø (cm)	Fondo contacto Ø (cm)	Ref.	€	
18	13,1	18418	17,94	6
20	15,8	18420	21,32	6
22	17,5	18422	22,44	6
24	19,1	18424	23,57	6
26	21	18426	25,81	6
28	22,5	18428	28,07	6

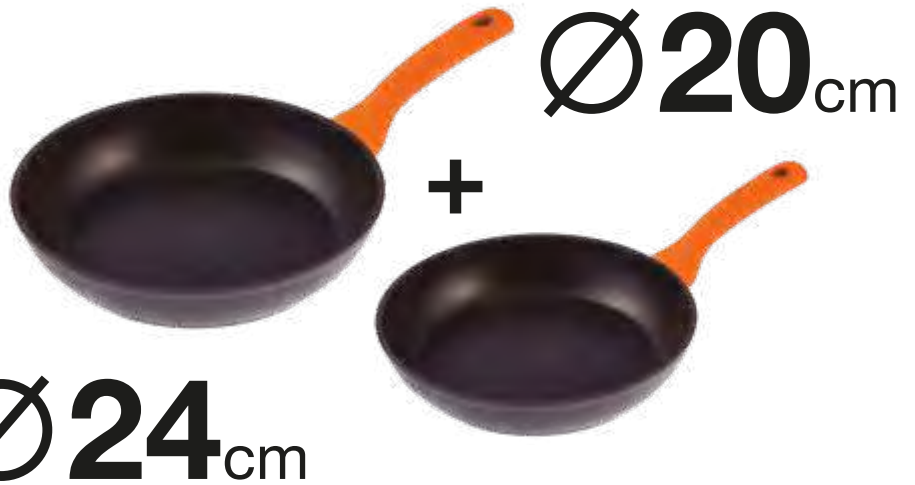

Set Wind

Ø (cm)	Ref.	€	
20 + 24	18433	43,82	6



Plancha Wind de asar
Wind deep fry pan
Plaque à grill Wind
Platte grill Wind

x, y (cm)	int (cm)	Ref.	€	
36 x 22, 5	29	18437	40,44	8
47 x 29	37,5	18447	56,19	8



Asas desmontables de silicona
Removable silicone handles

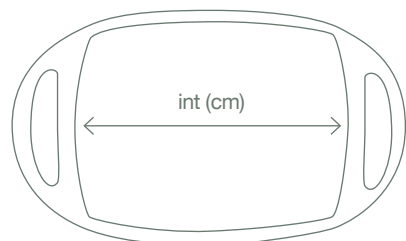



2 capas
2 layers

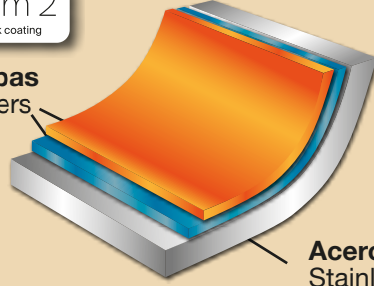

Acero Inoxidable
Stainless Steel



Acero Inoxidable
Stainless steel **18%**

166

- ESP**
- Acero inoxidable 18%.
 - Recubrimiento antiadherente Quantum2, libre de PFOA, preservando el Medio Ambiente.
 - Mango baquelita termoaislante.
 - Ahorro de energía por la utilización del fuego a

- baja intensidad.
- Es apta para todas las fuentes de calor (incluida la inducción).
- Apta para lavavajillas.



- ENG**
- 18% stainless steel.
 - Environmental-friendly, PFOA-free Quantum2 non-stick coating.
 - Heat-resistant Bakelite handle.

- Energy saving when used on low heat.
- Suitable for all heat sources (including induction).
- Dishwasher safe.



GREAT
RELEASE



EXCELLENT
DURABILITY



MADE WITHOUT
PFOs



REGULATORY
COMPLIANT

- FR**
- Acier inoxydable 18%.
 - Revêtement antiadhésif Quantum2, sans PFOA, préservant l'Environnement.
 - Manche bakélite thermo-isolant.
 - Économie d'énergie pour l'utilisation du feu à

- faible intensité.
- Elle est apte pour toutes les sources de chaleur (y compris l'induction).
- Lavable au lave-vaisselle.

- DE**
- Edelstahl 18%.
 - Quantum-Antihafbeschichtung, 3 Schichten, für maximale Haltbarkeit, frei von PFOA, umweltfreundlich.

- Wärmeisolierter Bakelitstie.
- Geeignet für alle Herdtypen, einschließlich Induktio.
- Spülmaschinenfest.

Sartén antiadherente Forma

Forma fry pan with non-stick surface
Poêle à revêtement anti-adhésif Forma
Spezial-Antihaftpfanne Forma

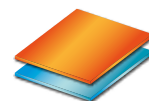

2 capas · 2 layers

Ø (cm)	Fondo contacto Ø (cm)	H (cm)	L	Ref.	€	
14	11,3	3	0,3	60314	16,87	-
16	12,5	3,8	0,5	60316	18,90	-
18	13	4,4	0,8	60318	21,14	-
20	15,3	5,0	1	60320	23,69	-
22	17,1	5,0	1,30	60322	28,43	-
24	19,1	5,0	1,75	60324	31,74	-
28	23	5,0	2,25	60328	39,59	-



INOX 18%

Sartén Forma

Forma fry pan
Poêle Forma
Pfanne Forma

Ø (cm)	Fondo contacto Ø (cm)	H (cm)	L	Ref.	€	
14	11,3	3	0,3	60148	11,81	6
16	12,5	3,8	0,5	60158	12,50	10
18	13	4,4	0,8	60160	13,69	10
20	15,3	5,0	1	60162	15,92	8
22	17,1	5,0	1,75	60163	21,21	8
24	19,1	5,0	1,75	60164	23,48	8
28	23	5,0	2,25	60168	30,23	6



INOX 18%

Sartén Forma Mini

Forma Mini fry pan
Poêle Forma Mini
Pfanne Forma Mini



Ø (cm)	Fondo contacto Ø (cm)	H (cm)	L	Ref.	€	
12	9,3	3	0,2	60142	11,60	-
14	11,3	3	0,3	60144	11,93	-
16	12,5	3,8	0,5	60146	12,62	-



INOX 18%

Sartén Forma Mini Antiadherente

Forma Mini fry pan with non-stick surface
Poêle à revêtement anti-adhésif Forma Mini
Spezial-Antihaftpfanne Forma Mini



Ø (cm)	Fondo contacto Ø (cm)	H (cm)	L	Ref.	€	
14	11,3	3	0,3	60145	16,87	-
16	12,5	3,8	0,5	60147	18,90	-



INOX 18%



TPBtech

*‘Colaborando con las mejores marcas’
‘collaborating with the best brands’*

Preparación

Preparation

La preparation

Zubereitung



Pasapurés, ralladores, rustideras...







Food mills, grates, roasters...

Moulins à légumes, râpes, plats à four...

Passiermülen, Reiben, Bräter...

Pasapurés y cedazosline



Ø (cm)

	15	18	20	22	24	26	28	30	32
						X			X
					X				
					X				
			X						
			X						
			X						
	X								
	15	18	20	22	24	26	28	30	32



Otras piezas
Other components

Ø (cm)

	12	16	20	24	26	28	30	32	37
	X	X	X	X	X	X			
			X				X		X

Otras piezas
Other components



8 x 8 cm



Pasapurés pequeño brillo
Small bright food mill
Presse-purée petit brillant
Passiergerät klein Glanz

Pasapurés y cedazosline



Pasapurés reforzado

Mixers
Presse-purée
Passiergerät



Ø (cm)	Cazoleta Ø (cm)	H (cm)	L	Ref.	€		
26	16,5	13	3 discos	5	52226	96,80	2
32	16,5	15	3 discos	8	52232	105,80	2

INOX 18/10 



Pasapurés brillo mango varilla

Bright mixers, inox handle
Presse-purée brillant, manche inox
Passiergerät Glanz Drahtgriff



Ø (cm)	Cazoleta Ø (cm)	H (cm)	L	Ref.	€		
24	10,2	12	D. Fijo	2,75	52240	32,94	6
24	10,2	12	3 discos	2,75	52242	37,55	6

INOX 18/10 



Pasapurés brillo mango baquelita

Bright mixers, baquelite handle
Presse-purée brillant, manche bakélite
Passiergerät Glanz Bakelitgriff



Ø (cm)	Cazoleta Ø (cm)	H (cm)	L	Ref.	€		
24	10,2	12	D. Fijo	2,75	52250	35,19	6
24	10,2	12	3 discos	2,75	52252	39,78	6

INOX 18/10 



Pasapurés brillo mango baquelita

Bright mixers, baquelite handle
Presse-purée brillant, manche bakélite
Passiergerät Glanz Bakelitgriff

Ø (cm)	Cazoleta Ø (cm)	H (cm)	L	Ref.	€		
20	11,5	8,5	D. Fijo	1,75	52201	25,57	6
20	11,5	8,5	3 discos	1,75	52221	30,21	6

INOX 18/10 

Ø (cm)	Cazoleta Ø (cm)	H (cm)	L	Ref.	€		
20	11,5	8,5	D. Fijo	1,75	52200	24,46	8
20	11,5	8,5	3 discos	1,75	52220	29,04	8

INOX 18/10 



Pasapurés Ecco Acero
Ecco Acero mixer
Presse-purée Ecco Acero
Passiergerät Ecco Acero

Ø (cm)	Cazoleta Ø (cm)	H (cm)	L	Ref.	€		
20	11,5	12	D. Fijo	1,75	52210	25,65	8
20	11,5	12	3 discos	1,75	52212	29,69	8

INOX 18/10



Pasapurés satinado mango varilla
Matt mixers inox handle
Presse-purée mat manche inox
Passiergerät matt Drahtgriff

Ø (cm)	Cazoleta Ø (cm)	H (cm)	L	Ref.	€		
20	11,5	8,5	D. Fijo	1,5	52172	20,51	8
20	11,5	8,5	3 discos	1,5	52223	25,44	8

INOX 18/10



Ø (cm)	Cazoleta Ø (cm)	H (cm)	L	Ref.	€		
20	11,5	8,5	D. Fijo	1,5	52173	21,82	6
20	11,5	8,5	3 discos	1,5	52224	26,78	6

INOX 18/10



Pasapurés pequeño brillo
Small bright food mill
Presse-purée petit brillant
Passiergerät klein Glanz

Ø (cm)	Cazoleta Ø (cm)	H (cm)	L	Ref.	€		
15	10,2	8,5	D. Fijo	1	52157	20,03	6
15	10,2	8,5	2 discos	1	52127	23,82	6

INOX 18/10

Ø (cm)	Cazoleta Ø (cm)	H (cm)	L	Ref.	€		
15	10,2	8,5	D. Fijo	1	52137	20,58	6
15	10,2	8,5	2 discos	1	52167	24,55	6

INOX 18/10



Pasapurés y cedazosline



Colgador
Hook

(*) Ø 12 cm Ø 16 cm Ø 20 cm
Ø 24 cm Ø 26 cm Ø 28 cm

Set 6 cedazos con malla
Set 6 sieve with mesh
Set 6 tamis avec maille
Set 6 Mehlsieb mit gitter

Ø (cm)	Ref.	€	
(*)	67740	34,47	12

INOX 



Caldero semiesférico
Semi-spherical mixing bowl
Bassine hemispherique
Rührschüssel halbrund

Cedazo con malla
Sieve with mesh
Tamis avec maille
Mehlsieb mit gitter



Ø (cm)	Paso		Ref.	€	
20	F	1 mm	67721	19,01	-
20	M	2 mm	67722	18,98	-
20	G	5 mm	67723	18,39	-
30	F	2 mm	67731	25,46	-
30	M	5 mm	67732	24,86	-
30	G	6 mm	67733	24,30	-
37	F	2 mm	67737	29,40	-
37	M	5 mm	67738	28,81	-
37	G	7 mm	67739	28,22	-



Cedazo suministrado con malla
Sieve supplied with mess
Tamis livré avec toile
Mehlsieb geliefert mit Gitter

INOX

Mallas individuales intercambiables
Individual interchangeable meshes
Individuel interchangeable mailles
Einzel ersatzgitter

Ø (cm)	Paso	Ref.	€	
20	M	67742	5,50	-
20	G	67743	4,92	-
30	F	67751	8,06	-
37	F	67761	10,05	-
37	M	67762	9,44	-
37	G	67763	8,86	-

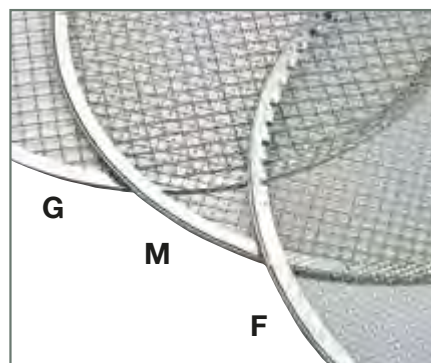

Mallas intercambiables adicionales
Interchangeable mess
Toiles interchangeables supplémentaires
Zusätzliche Ersatzgitter

INOX

F : Fino · Fine · Fin · Fein
M : Medio · Medium · Moyen · Mittelfein
G : Grueso · Coarse · Gros · Grob



Caldero cónico
Conical mixing bowl
Bassine pâtisseries
ührschüssel konisch



Caldero cónico

Conical mixing bowl
Bassine pâtisseries
ührschüssel konisch

Sin asas · Without handles · Sans poignée · Ohne henkel

Ø (cm)	H (cm)	L	Ref.	€	
14	9	0,9	67513	9,95	-
16	10	1,25	67515	11,20	-
20	12	2	67519	16,22	-
24	13	3,25	67523	19,97	-
28	14	5	67527	25,79	-
32	15	7	67531	27,55	-
36	16	10	67535	37,32	-

Con asas · With handles · À poignée · Mit henkeln

Ø (cm)	H (cm)	L	Ref.	€	
28	14	5	67528	34,71	-
32	15	7	67532	37,96	-
36	16	10	67536	47,23	-

INOX 18/10 

Bolset

Bolset
Bolset
Schüssel

Ø (cm)	L	Ref.	€	
12	0,33	53120	8,63	-
21	2	99077	15,81	-

INOX 18/10 

Caldero semiesférico

Semi-spherical mixing bowl
Bassine hemispherique
Rührschüssel halbrund

Sin asas · Without handles · Sans poignée · Ohne henkel

Ø (cm)	H (cm)	L	Ref.	€	
28	16	7	67628	46,68	-
32	18	10	67632	53,86	-

Con asas · With handles · À poignée · Mit henkeln

Ø (cm)	H (cm)	L	Ref.	€	
28	16	7	67630	53,44	-
32	18	10	67634	60,60	-

Con base · With stand · À pied · Mit fuss

Ø (cm)	H (cm)	L	Ref.	€	
28	16	7	67629	61,93	-
32	18	10	67633	76,08	-

INOX 18/10 





Escurreidor cónico

Conical colander
Passoire conique
Abtropfschüssel

Con asa y base · With handle and stand
Avec poignée et à pied · Ohne henkel und mit fuss

Ø (cm)	H (cm)	L	Ref.	€	
28	14	5	67529	51,97	-
32	15	7	67533	56,71	-
36	16	10	67537	63,78	-

INOX 18/10 



Escurreidor con base

Colander with stand
Passoire à pied
Durchschlag mit fuss

Ø (cm)	H (cm)	L	Ref.	€	
20	10	2,5	50134	21,58	20
22	11	2,5	50234	23,64	20
24	12	3	51284	24,61	11
28	14	5	51294	32,12	6

INOX 18/10 



Escurreidor con mango de varilla

Colander with rod-type handle
Passoire avec manche en fil d'acier
Durchschlag mit drahtgriff

Ø (cm)	H (cm)	L	Ref.	€	
20	7	1,75	53018	15,06	8

INOX 18/10 



Escurreidor con mango

Colander with handle
Passoire avec manche
Durchschlag mit griff

Ø (cm)	H (cm)	L	Ref.	€	
20	7	1,75	53020	15,74	6

INOX 18/10 



Escurreidor Ecco Acero

Ecco Acero colander
Passoires Ecco Acero
Durchschlag Ecco Acero

Ø (cm)	Ref.	€	
20	65220	16,32	-

INOX 18/10 





Juego de 4 cazos de medida

Measuring cup 4 pieces
Esemble de 4 dosettes
4 Messbecher

-	Ref.	€	
-	15015	18,11	6

INOX 18% 



Juego de 5 cucharas de medida

5 pieces measuring set
Esemble de 5 cuilleres à doser
5 Messlöffel

-	Ref.	€	
-	14005	16,22	24

INOX 18% 



Cacillo dosificador de café

Measured coffee
Café mesurée
Gemessen Kaffee

x (cm)	Ref.	€	
15,5	55070	6,75	20

INOX 18/10 



Jarra zumo con visor lateral

Juice jug with side level indicator
Carafe a jus de fruits avec niveau visible
Saftkanne mit seitlicher messkala

Ø (cm)	H (cm)	L	Ref.	€	
12	13	1	55108	25,74	12

INOX 18/10 



Graseras

Oil bottle with gift box
Récipient pour huile de friture dans écriin
Bratölbehälter in Kasten

Pescado · Fish · Poisson · Fisch

Ø (cm)	H (cm)	L	Ref.	€	
10	12	0,75	61010	18,24	6

INOX 

Carne · Meat · Viande · Fleisch

Ø (cm)	H (cm)	L	Ref.	€	
10	12	0,75	61011	18,24	6

INOX 



Aprovechamiento de aceite
Oil recovery



Aceitera antigoteo

Anti-drip oil dispenser
Huillier anti-goutte
Tropffreier Ölspender

Ø (cm)	H (cm)	L (ml)	Ref.	€	
6	20	300	61326	8,68	12
6,5	23,5	500	61328	9,11	12

Vidrio
Glass 



Rallador 4 caras
 Four-way grater
 Râpe 4 faces
 Reibe 4 Seiten



Ralladoresline



Rallador plano tres usos
 3 uses grater
 Rape 3 usages
 Dreifunktions-Reibe



x (cm)	y (cm)	Ref.	€	
29,1	11,5	54716	6,95	12

INOX 18% 



Rallador 4 caras
Four-way grater
Râpe 4 faces
Reibe 4 Seiten

x (cm)	x (cm)	H (cm)	Ref.	€	
New 8	5,5	18	54696	6,95	12
9	6	21	54698	9,10	12
10,5	8	24,5	54700	9,75	12

INOX 18% 



4 caras
Four-way grater



Rallador 6 caras
Six sided grater
Râpe 6 faces
Reibe 6 Seiten

x (cm)	y (cm)	H (cm)	Ref.	€	
10,5	8,2	24,5	54702	11,25	24

INOX 18% 



Rallador de manivela Elite
Elite grater Mill
Moulin à fromage Elite
Reibmühle Elite

x (cm)	Ref.	€	Pack
20	13332	18,18	1

INOX 18% 





Rallador semicircular con mango Elite
 Elite semicircular grater with handle
 Râpe semi-circulaire avec manche Elite
 Halbbrunde Reiber mit Griff Elite



x (cm)	y (cm)	H (cm)	Ref.	€	
25,2	5,7	2,5	54720	5,95	12

INOX



Rallador plano mango ABS paso medio
 Flat medium grater, ABS handle
 Râpe plate manche ABS, moyenne
 Flache Reibe ABS-Griff mittel

y (cm)	x (cm)	H (cm)	Ref.	€	
33	7	2	54732	12,25	12

INOX 18/10

Mango ABS · ABS handle
 Manche ABS · Griff ABS



Funda protectora · Protective cover
 Gaine de protection · Schutzüberzug



Rallador plano con depósito
 Flat fine grater with container
 Râpe plate avec récipient
 Flache Reibe mit Behälter

Medio · Medium · Moyenne · Mitte

y (cm)	x (cm)	H (cm)	Ref.	€	
30,8	7	7,2	54752	12,85	-

Bidireccional · Two Way · Bidirectionnelle · Bidirektionales

y (cm)	x (cm)	H (cm)	Ref.	€	
30,8	7	7,2	54754	12,85	-

INOX 18/10



Patitas de goma para un apoyo seguro
Rubber feet for secure footing

183

Rallador mango ABS
Grater ABS handle
Râpe à manche ABS
Stabreibe ABS-Griff



x (cm)	Ref.	€	
31	54761	9,95	6

INOX 18/10 





Picaperejil Elite

Elite fine herbs mincer
 Hachoir à manivelle pour fines herbes Elite
 Kräutermühle, fein rostfrei Elite

Ø (cm)	x (cm)	H (cm)	Ref.	€	
9	19	6	13336	19,92	6

INOX 



Desmontable, fácil de limpiar y guardar
 Detachable, easy to clean and store



184



Prensa ajos Elite

Elite garlic press
 Presse-ail Elite
 Knoblauchpresse Elite

x (cm)	Ref.	€	
20	13306	17,99	6

INOX 18% 



Picador automático Elite

Elite onion chopper
Hachoir-oignon Elite
Zwiebelhacher Elite

Ø (cm)	H (cm)	Ref.	€	
9	21	13334	23,63	6

INOX 

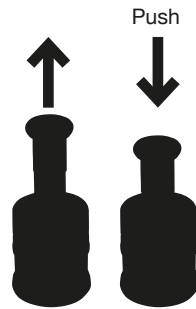

Sencillo y rápido · Quick & simple



Con depósito transparente
With see-through tank

Prensapatatas cónico Elite

Elite conical potato press
Presse-pomme conique de terre Elite
Konische Kartoffel-Pressen Elite

x (cm)	y (cm)	Ref.	€	
8	8	13340	29,21	6

INOX 





Balanza Nutricional
Nutritional scale
Balance diététique
Nährwertwaage



	H (cm)	x (cm)	y (cm)	Ref.	€	
Black	1,5	22,5	15,5	61462	47,21	-
White	1,5	22,5	15,5	61463	47,21	-



Superficie táctil
Tactile Surface
Surface Tactile
Tast-Oberfläche

1gr.

Resolución: 1 g/ 0.1 oz
Graduation: 1 g/ 0.1 oz
Précision: 1 g/ 0.1 oz
Auflösung: 1 g/ 0.1 oz



Capacidad: 5 kg (11 lb.)
Capacity: 5 kg (11 lb.)
Porteée: 5 kg (11 lb.)
Tragkraft: 5 kg (11 lb.)



Con 999 memorias para almacenar diferentes valores nutricionales de alimentos.
With 999 repors to store different nutritional values food.

186



Units: kg · Lb · St

Báscula Dinamic
Nutritional scale
Balance diététique
Nährwertwaage

x (cm)	Ref.	€	
12	61470	27,30	-



Capacidad: 50 kg (110 lb.)
Capacity: 50 kg (110 lb.)
Porteée: 50 kg (110 lb.)
Tragkraft: 50 kg (110 lb.)



Balanza de pared
Wall scales
Balance murale
Wandwaage



-	Ref.	€	
-	61468	33,77	6



Con Temporizador y Reloj
Clock and Timer
Horloge et Minuteur
Uhr-und Timerfunktion

1gr.

Resolución: 1 g/ 0.1 oz
Graduation: 1 g/ 0.1 oz
Précision: 1 g/ 0.1 oz
Auflösung: 1 g/ 0.1 oz



Capacidad: 3 kg (6,6 lb.)
Capacity: 3 kg (6,6 lb.)
Porteée: 3 kg (6,6 lb.)
Tragkraft: 3 kg (6,6 lb.)



INOX 18%



Bandeja rectangular

Rectangular dishe
Plat rectangulaire
Tablett rechteckig

x (cm)	ext (cm)	H (cm)	Ref.	€	
21x15	24,0 x 16,2	1,3	55028	7,54	-
30x21	37,0 x 22,2	1,5	59015	14,63	-
35x26	40,2 x 28,2	1,6	59017	16,37	-
40x31	42,2 x 32,2	1,8	59019	20,10	-

INOX 18% 



Bandeja 'Llauna'

Steel Baking tray
Plaque de cuisson en acier
Backblech aus Stahl

int (cm)	ext (cm)	H (cm)	Ref.	€	
21x15	24,0 x 16,2	2,5	59043	8,48	10
30 x 21	37,0 x 22,2	2,5	59045	14,15	10
35 x 26	40,2 x 28,2	2,5	59047	17,14	10
40 x 31	42,2 x 32,2	2,5	59049	21,23	6

INOX 18% 



Rustidera rectangular asa monobloc

Rectangular roasting tin monobloc handle
Plat à gratin rectangulaire poignée monobloc
Bratform rechteckig Griffwand

int (cm)	ext (cm)	H (cm)	Ref.	€	
18 x 13	21, 8 x 14, 2	3	59089	8,27	15
21x15	24,0 x 16,2	3,5	59091	10,32	10
30 x 21	37,0 x 22,2	5,5	59095	17,04	10
35 x 26	40,2 x 28,2	5,5	59097	21,53	10
40 x 31	42,2 x 32,2	6	59099	27,76	6

INOX 18% 



Rustidera con asa

Roasting tin with handle
Plat à gratin avec poignée
Bratform mit griff

int (cm)	ext (cm)	H (cm)	Ref.	€	
38,1 x 30	40,5 x 32	6	59199	32,81	-
50 x 40	52,2 x 42,2	8	59250	84,02	-

INOX 18% 



Base madera
Wood base
Socle en bois
Holzsockel



Para recipientes de 30x21cm y 21x15cm
For recipients of 30x21cm and 21x15cm

INOX 18/10

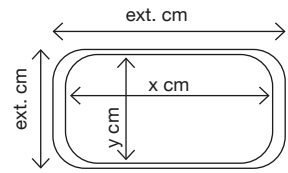

Bandeja 'Llauna'
Steel Baking tray
Plaque de cuisson en acier
Backblech aus Stahl

int (cm)	ext (cm)	H (cm)	Ref.	€	
21x15	24,0 x 16,2	2,5	18043	9,73	10
30 x 21	37,0 x 22,2	2,5	18045	19,68	10
35 x 26	40,2 x 28,2	2,5	18047	25,03	10
40 x 31	42,2 x 32,2	2,5	18049	28,66	6



189

INOX 18/10

Rustidera rectangular asa monobloc
Rectangular roasting tin monobloc handle
Plat à gratin rectangulaire poignée monobloc
Bratform rechteckig Griffband

int (cm)	ext (cm)	H (cm)	Ref.	€	
21x15	24,0 x 16,2	3,5	18091	12,79	10
30 x 21	37,0 x 22,2	5,5	18095	23,18	10
35 x 26	40,2 x 28,2	5,5	18097	30,69	10
40 x 31	42,2 x 32,2	6	18099	39,85	6



INOX 18/10

Rustidera con asa
Roasting tin with handle
Plat à gratin avec poignée
Bratform mit griff

int (cm)	ext (cm)	H (cm)	Ref.	€	
38,1 x 30	40,5 x 32	6	18199	45,45	-
50 x 40	52,2 x 42,2	8	18250	100,12	-



INOX 18/10

INOX 18%



Set de 3 fuentes para tapas

Set of 3 snack trays
Set 3 assiettes à tapas
Satz 3 platte für tapas

x (cm)	y (cm)	Ref.	€	
18	13	59272	26,00	6

INOX 18% 



Kit especial rebozados

Battering kit
Kit à enrober
Panierset

x (cm)	y (cm)	Ref.	€	
21	15	59271	32,10	6

INOX 18% 



Set fuentes horno David de Jorge

David de Jorge roasting tin set
Set David de Jorge plat à gratin
Satz David de Jorge Bratform

x (cm)	Ref.	€	
30 + 35	90168	39,09	4

INOX 18% 



Rustideras rectangulares asa monobloc (más info. en página anterior)
Rectangular roasting tins monobloc handle (more info. on previous page)



Fuente oval-honda borde vuelto

Deep oval dish out-turned edge
Plat ovale creux bord rabattu
Schale tief oval rundrand

x (cm)	y (cm)	H (cm)	Ref.	€	
35	24	4	59075	11,74	6
40	26	4,5	59077	14,63	6
45	29	5	59079	16,23	6
50	31	5	59081	19,38	5

INOX 18% 



INOX

Bandeja ración 13 x 14 cm

Snack tray 13 x 14 cm
Assiette tapas 13 x 14 cm
Platte für tapas 13 x 14 cm

x (cm)	y (cm)	Ref.	€	
13	14	53067	8,29	10

INOX



Set fuentes horno + 1 manopla

Roasting tin set + 1 oven glove
Set plat à gratin + 1 gant pour le four
Satz Bratform + 1 Textilhandschuhe

x (cm)	Ref.	€	
35 + 40	59270	35,50	4

INOX 18%



INOX 18/10

Fuente oval-honda borde vuelto

Deep oval dish out-turned edge
Plat ovale creux bord rabattu
Schale tief oval rundrand

x (cm)	y (cm)	H (cm)	Ref.	€	
35	24	4	18075	17,53	6
40	26	4,5	18077	20,54	6
45	29	5	18079	23,04	6
50	31	5	18081	26,72	5

INOX 18/10



INOX 18%

**Bandeja oval borde vuelto**

Oval dish out-turned edge

Ovale plat bord rabattu

Buffet-Tablet oval

x (cm)	y (cm)	Ref.	€	
20	13	59068	4,15	-
25	17	59070	6,00	-
30	20	59072	6,58	-
35	24	59074	8,15	-
40	27	59076	9,98	-
45	29	59078	11,56	-
50	31	59080	14,28	-
70	45	59054	35,39	-
80	48	59056	41,05	-

INOX 18% **Bandejas de pescado**

Special dimension dishes

Plats dimensions spéciales

Tabletts Sondermaße

x (cm)	y (cm)	Ref.	€	
60	27	59082	20,12	-
80	30	59084	25,22	-

INOX 18% 



INOX 18/10



Bandeja oval borde vuelto

Oval dish out-turned edge
Ovale plat bord rabattu
Buffet-Tablet oval

x (cm)	y (cm)	Ref.	€	
20	13	18068	6,15	-
25	17	18070	7,84	-
30	20	18072	9,81	-
35	24	18074	12,16	-
40	27	18076	16,19	-
45	29	18078	18,50	-
50	31	18080	22,20	-

INOX 18/10 



Bandejas de pescado

Special dimension dishes
Plats dimensions spéciales
Tabletts Sondermaße

x (cm)	y (cm)	Ref.	€	
60	27	18082	27,19	-
80	30	18084	37,16	-

INOX 18/10 

Especial GRILL-BARBACOA

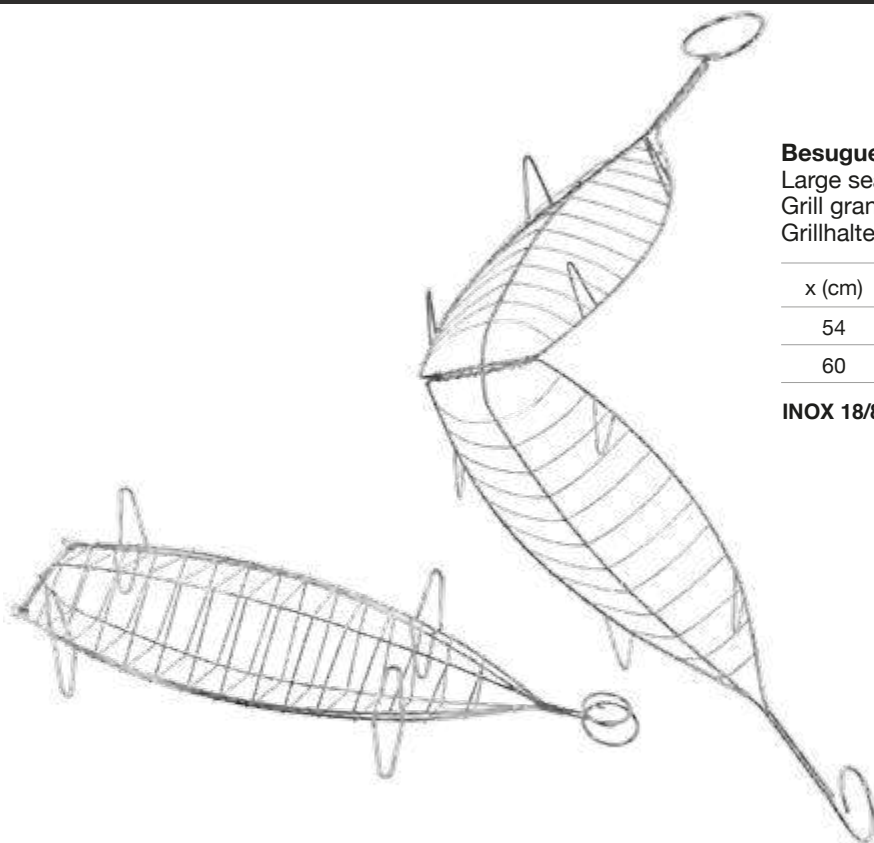

Besuguera

Large sea bream grill
Grill grande poissonnière
Grillhalter für Fisch

x (cm)	y (cm)	H (cm)	Ref.	€	
54	13,5	8	53670	45,04	3
60	19	15	53675	59,21	3

INOX 18/8 



194

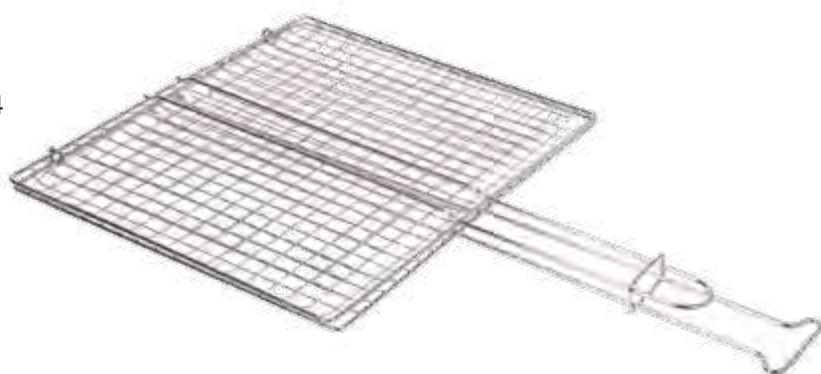

Parrilla doble 18/8

Sea bream grill 18/8
Grill poisson 18/8
Fisch-Grillrost 18/8

x (cm)	y (cm)	Ref.	€		
25	30	53655	62,73	3	
30	35	53660	69,26	3	
30	35	53661	69,90	3	(*)
40	45	53665	100,41	3	
40	45	53666	102,28	3	(*)

INOX 18/8 



(*) Parrilla doble CON PATAS
Double grill WITH LEGS

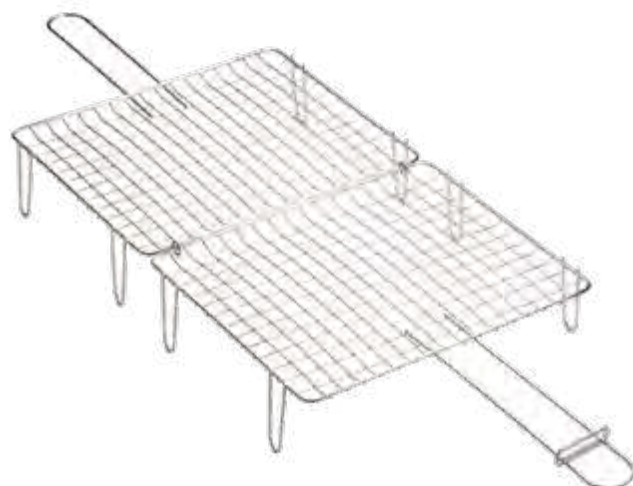



Parrilla sobremesa inoxidable
Stainless steel table grill
Grill de table inoxydable
Tischgrillrost aus Edelstahl

x (cm)	y (cm)	h (cm)	Ref.	€	
25	20	12,5	53678	109,95	

INOX 18/8 



195

Parrilla verduras
Vegetable grill
Grille à légumes
Gemüsegrillrost

	x (cm)	y (cm)	h (cm)	Ref.	€	
6 uds.	42,5	24,5	8,5	53676	31,95	5
9 uds.	50	24,5	8,5	53677	35,95	5

INOX 





Paleta
Spatula
Spatule
Spatula

a (cm)	b (cm)	c (cm)	Ref.	€	
6	11	27	13463	7,83	12

INOX  



Paleta Pizza
Pizza spatula
Spatule pizza
Pizza Spatula

a (cm)	b (cm)	c (cm)	Ref.	€	
8	12,5	30	13450	9,03	12

INOX  



Espátula triangular
Triangular spatula
Spatule triangulaire
Spatula triangolare

a (cm)	b (cm)	c (cm)	Ref.	€	
6	12,5	28	13452	6,63	12

INOX  





Espátula perforada
Perforated spatula
Spatule lisse poignée
Pfannenschaufel

a (cm)	b (cm)	c (cm)	Ref.	€	
7,5	15	33	13460	8,43	12
7,5	20	38	13461	9,27	12
7,5	25	42	13462	10,85	6

INOX

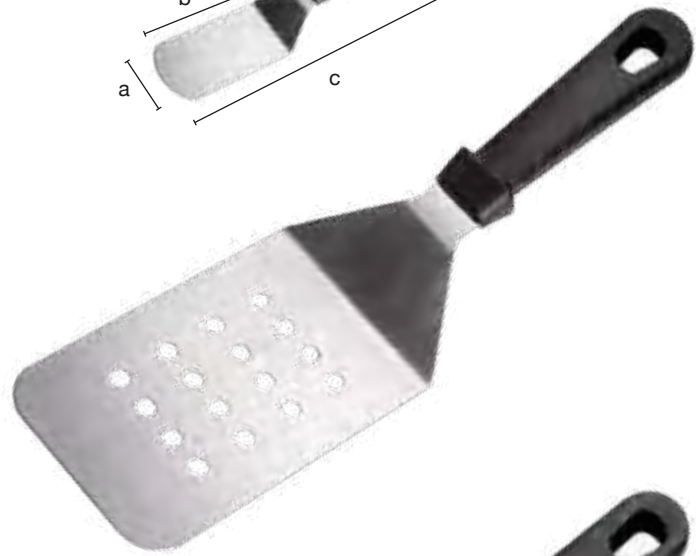
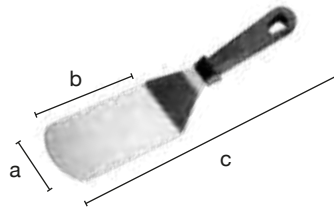

Espátula lisa
Straight spatula
Spatule lisse
Backschaufel

a (cm)	b (cm)	c (cm)	Ref.	€	
7,5	15	33	13465	8,43	12
7,5	20	38	13466	9,27	12
7,5	25	42	13467	10,85	12

INOX



Espátula larga recta
Long straight spatula
Spatule longue droite
Palette

a (cm)	b (cm)	c (cm)	Ref.	€	
3	10	21,5	13470	3,85	12
3	15	27	13472	4,82	12
3,5	20	32	13474	6,02	12
3,5	25	38	13476	7,22	12

INOX



Espátula larga acodada
Long bent spatula
Spatule longue coudée
Winkelpalette

a (cm)	b (cm)	c (cm)	Ref.	€	
3	10	25	13480	3,85	12
3	15	30	13482	6,02	12
3,5	20	37	13484	7,22	12
3,5	25	43	13486	8,43	12
3,5	30	48	13488	9,63	12

INOX





Pinza grill Nylon

Nylon tipped Grill tongs
Pince Grill pointes nylon
Grillzange Nylongreifer

x (cm)	Ref.	€	
30	53630	6,51	12
35	53635	7,55	12

INOX 



Pinza barbacoa

All stainless steel barbecue tongs
Pince barbecue tout inox
Grillzange

x (cm)	Ref.	€	
25	53725	4,83	10
30	53730	5,51	10
35	53735	6,88	100

INOX 18% 



Pinza especial dentada

Special toothed tong
Pince dentée spéciale
Specialzange mit Zähnen

x (cm)	Ref.	€	
20	13404	6,95	10

INOX 18% 



Pinza profesional con guía
 Stainleel steel fish grill
 Pince professionnelle avec guide
 Profi-Zange mit Schiene

x (cm)	y (cm)	H (cm)	Ref.	€	
33	10	1,5	53645	16,02	6
New 45	10	1,5	53646	22,95	6

INOX 18/8

Con guía para evitar el cruce
 With guide in order not to be crossed

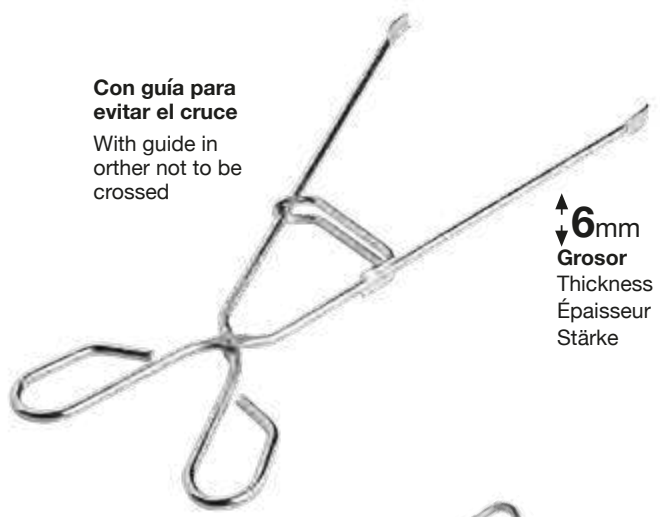

↑ 6mm
 ↓ **Grosor**
 Thickness
 Épaisseur
 Stärke

Pinza pala silicona 35
 Stainleel steel tong with silicone scoop 35
 Pince spatule silicone 35
 Zange mit silikongreifer 35

x (cm)	y (cm)	H (cm)	Ref.	€	
35	9	4	53643	7,85	6

INOX

↑ 5mm
 ↓ **Grosor**
 Thickness
 Épaisseur
 Stärke



Pinza pala larga inox
 Stainleel steel barbecue tong
 Pince spatule longue
 Grillzange langer Stiel

x (cm)	y (cm)	H (cm)	Ref.	€	
35	9	4	53640	5,67	6
New 55	9	4	53641	13,75	6

INOX 18/8

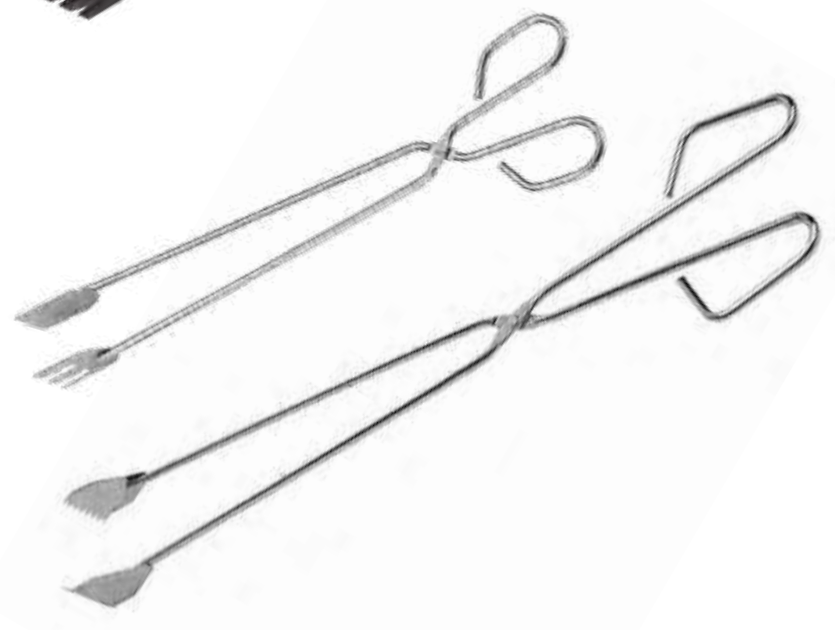

Set de 6 pinchos para brocheta
 Set Of 6 Round Skewers
 Set 6 Brochettes Carré Inox
 Fleischspiesse Rostfrei (6 Stück)

x (cm)	Ref.	€	
30	53125	9,39	100

INOX



Con protector
 With protective





Molde forma nube
Baking mould cloud
Cercle nuage à moule cuisine
Backform cloud

Ø (cm)	Ref.	€	
8	59412	3,82	6

INOX 18%



Molde forma corazón
Baking mould heart
Cercle cœur à moule cuisine
Backform herz

Ø (cm)	Ref.	€	
8	59414	3,82	6

INOX 18%



Molde extensible para reposteria
Adjustable pastry ring
Cercle extensible
Einstellbare Gebäck Ring

H (cm)	Ref.	€	
8,5	59410	15,76	24

INOX 18%

← extensible de Ø 16cm a 30cm →



Cazo Profesional salsas
Professional pouring saucepan
Casserole à sauce professional
Professional Saucenpfännchen

Ø (cm)	Ref.	€	
12	14007	11,12	20



INOX 18%



Fuente especial horno antiadherente
Special oven-safe, non-stick dish
Plat spécial four antiadhésif
Spezielle Backofenschüssel, antihafbeschichtet

Ø (cm)	H (cm)	L	Ref.	€	
14	5,5	0,6	50015	11,10	-
16	7	1	50017	12,23	-
20	7	2	50038	14,57	-

INOX 18/10



Batidor mecánico automático
Automatic mechanical egg whisk
Fouet mécanique automatique
Automatische Mechanische Rührbesen

H (cm)	x (cm)	Ref.	€	
25	5	53221	8,29	24
35	7	53220	8,95	10

INOX 18/10

Batidor mecánico, uso manual, sin cables, no necesita ni electricidad ni batería.
Cable-free mechanical whisk for manual use, does not need electricity or battery.
Fouet mécanique, usage manuel, sans câbles, qui ne requiert ni électricité ni batterie.
Praktischer handbetriebener Quirl, ohne Stromkabel und ohne Batterie.

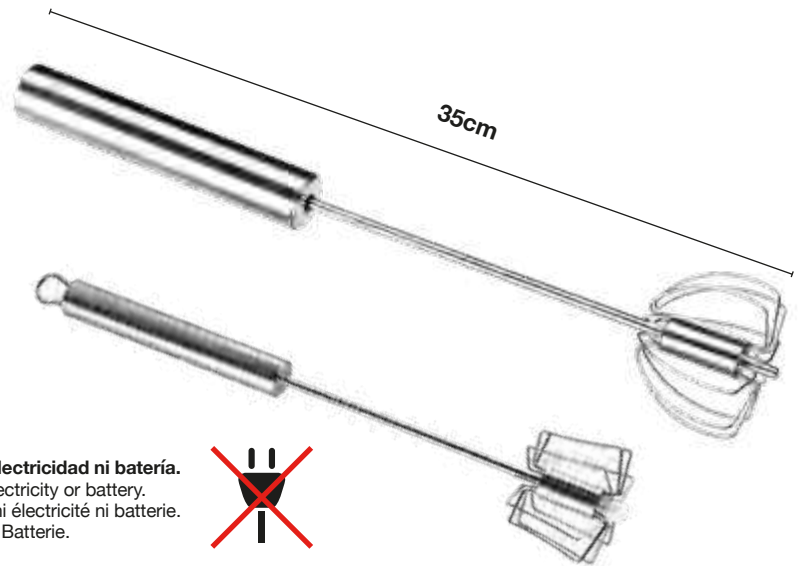

Racionador de helado Elite
Elite Ice cream scoop
Cuillère a glace Elite
Eisportionierer Elite

x (cm)	Ref.	€	
21,5	13312	7,73	6

INOX 18%



Racionador de helado Elite
Elite Ice cream scoop
Boule a glaces Elite
Eisportionierer Elite

Ø (cm)	Ref.	€	
4,5	13366	21,29	12
5,0	13368	21,29	12
5,5	13370	21,29	12
6,0	13372	21,29	12
6,5	13374	21,29	12

INOX 18%



Flanero exterior pulido, satinado interior
Custard mould
Moule à flan
Puddingform aussen poliert innen geschliffen

Ø (cm)	H (cm)	L	Ref.	€	
7	5,7	0,20	53071	1,70	12
8	5,7	0,22	53081	1,82	12

INOX

Flanero pulido exterior
Custard mould
Moule à flan
Puddingform aussen poliert innen satiniert

Ø (cm)	H (cm)	L	Ref.	€	
6	4,5	0,16	53060	2,97	12
7	5,5	0,18	53070	3,15	12
8	5,5	0,20	53080	3,27	12

INOX 18/10



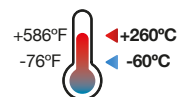

Silicone

Salvamangos silicona
Silicone handle saver
Protecteur manches en silicone
Silikongriffschutz

x (cm)	y (cm)	Ref.	€	
15	4,5	53990	10,49	-

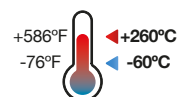

Silicone

Set 2 asas de silicona
2 Silicone handles set
Set 2 poignées silicone
2 Silikongriffe satz

-	Ref.	€	
-	53996	8,74	100



Pinza tenaza para bandeja horno
Tongs for oven tray
Pince pour grille four
Zange für Backblech

-	Ref.	€	
-	53115	9,23	50

INOX 18%



Set de 2 manoplas textiles
2 Textile oven gloves set
Set 2 gants pour le four
2 Textilhandschuhe satz

Ref.	€	
10211	10,57	-



Utensilios

Tools

Le matériel de cuisine

Utensilien



Coladores, pizza, pinzas, complementos...

Strainers, pizza, tongs, complements...

Passoire, pizza, pinces, compléments...

Küchensets, Pizza, Zangen Küchenzubehör...



Cazo Force
Force ladle
Louche Force
Schöpfkelle Force

Ø (cm)	x (cm)	L	Ref.	€	
9,5	38	0,125	13151	14,42	12
10,2	40,5	0,25	13152	18,44	12

INOX 18/10



Espumadera Force
Force skimmer
Écumoire Force
Schaumlöffel Force

x (cm)	y (cm)	Ref.	€	
38	11,5	13161	14,05	12

INOX 18/10



Espátula Force
Force spatula
Spatule Force
Pfannenschaufel Force

x (cm)	y (cm)	Ref.	€	
38	9	13171	12,25	12

INOX 18/10



Espátula prensador Force
Force pressing spatula
Palette pour presser Force
Pressvorrichtung schaufel Force

x (cm)	Ref.	€	
32	13193	17,66	12

INOX 18/10



Tenedor Force
Force fork
Fourchette Force
Tranchiergabel Force

x (cm)	Ref.	€	
38	13191	10,08	12

INOX 18/10

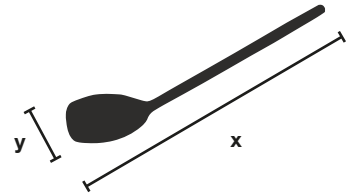

Cuchara Force
Force spoon
Cuillère Force
Servierlöffel Force

x (cm)	y (cm)	Ref.	€	
38	7	13181	11,63	12

INOX 18/10

Cuchara espagueti Force
Spaguetti Force spoon
Spaguetti cuillère Force
Spaghettiheber Force

x (cm)	Ref.	€	
38	13192	13,30	12

INOX 18/10



Forceline



↑ ↓
1,2mm
Grosor
Thickness
Épaisseur
Stärke

Cazos una pieza
One-piece ladle
Louches une pièce
Schöpfkelle einteilig

Ø (cm)	x (cm)	L	Ref.	€	
9	39	0,20	55309	14,48	-
12	45	0,50	55312	19,66	-
14	49	0,75	55314	22,77	-
16	55	1	55316	25,05	-

INOX 18/10



Espumaderas una pieza
One-piece skimmer
Écumoire en une pièce
Schaumlöffel einteilig

Ø (cm)	x (cm)	Ref.	€	
8	37	55318	10,75	-
9	39	55319	12,61	-
10	43	55320	13,28	-
12	45	55322	15,39	-
14	49	55324	17,76	-
16	55	55326	19,15	-

INOX 18/10



Espumadera de malla especial
Special mesh skimmer
Écumoire tamis spéciales
Spezielle Mesh Abschäumer

Ø (cm)	x (cm)	Ref.	€	
20	50	53256	17,52	6

INOX 18%



Cazo de malla y varilla reforzada
 Stiffened mesh and wire ladle
 Louche tamis et fil renforcé
 Fritierkelle Draht und Gitter verstärkt

Ø (cm)	x (cm)	Ref.	€	
9	39	53176	21,07	-
12	45	53178	22,40	-
14	49	53180	22,69	-
16	55	53182	23,02	-

INOX 18/10 

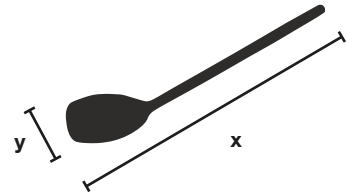

Espumaderas reforzadas varilla y malla
 Reinforced mesh-wire skimmer
 Écumoire fil-tamis renforcée
 Fritierlöffel Draht und Gitter verstärkt

Ø (cm)	x(cm)	Ref.	€	
10	30	53610	11,95	50
12	39	53612	12,18	100
14	46	53614	14,70	50
16	49	53616	19,38	50
18	50	53618	20,79	50
24	53	53624	26,16	25

INOX 18/10 

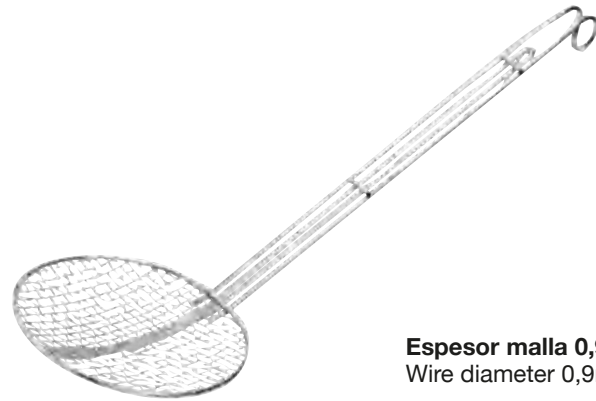

Espesor malla 0,9mm
 Wire diameter 0,9mm

Paso de malla 5,45mm
 Opening 5,45mm





Cazo Inox Line
Inox Line ladle
Louche Inox Line
Schöpfkelle Inox Line

Ø (cm)	x (cm)	y (cm)	Ref.	€	
9	35	9	42052	9,95	-

INOX 18%



Espumadera Inox Line
Inox Line skimmer
Écumoire Inox Line
Schaumlöffel Inox Line

Ø (cm)	x (cm)	y (cm)	Ref.	€	
10,5	35	10,5	42062	6,44	-

INOX 18%



Espátula Inox Line
Inox Line spatula
Spatule Inox Line
Pfannenschaufel Inox Line

x (cm)	y (cm)	Ref.	€	
35	8	42072	5,86	-

INOX 18%

Wok antiadherente Professional
Professional wok with non-stick surface
Wok à revêtement anti-adhésif Professional
Antihaf wok Professional

Cuchara Inox Line
Inox Line spoon
Cuillère Inox Line
Servierlöffel Inox Line





Cuchara Inox Line
 Inox Line spoon
 Cuillère Inox Line
 Servierlöffel Inox Line

x (cm)	y (cm)	Ref.	€	
35	7	42082	5,79	-

INOX 18%

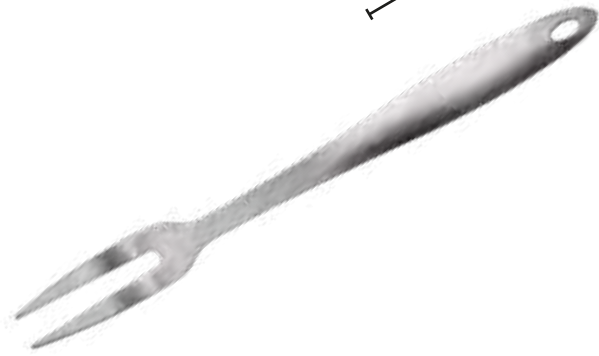
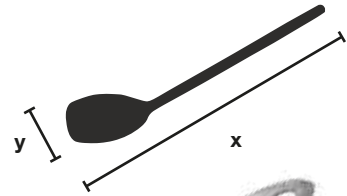

Tenedor Inox Line
 Inox Line fork
 Fourchette Inox Line
 Tranchiergabel Inox Line

x (cm)	y (cm)	Ref.	€	
35	3	42092	8,18	-

INOX 18%



Inoxline



Cazo Nylon
Nylon ladle
Louche Nylon
Schöpfkelle Nylon

x (cm)	y (cm)	L	Ref.	€	
33	9	0,1	35351	4,03	36

INOX 18%



Espátula perforada Nylon
Nylon perforated spatula
Spatule lisse poignée Nylon
Pfannenschaufel Nylon

x (cm)	y (cm)	Ref.	€	
33	8	35371	4,03	36

INOX 18%



Cuchara espagueti Nylon
Nylon spaghetti spoon
Spaguetti cuillère Nylon
Spaghettiheber Nylon

x (cm)	y (cm)	Ref.	€	
33	6,5	35382	4,03	36

INOX 18%



Espátula acodada Nylon
Nylon bent spatula
Spatule coudée Nylon
Spatule coudée Nylon

x (cm)	y (cm)	Ref.	€	
33	8	35372	4,03	36

INOX 18%

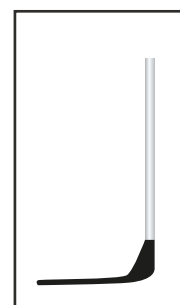

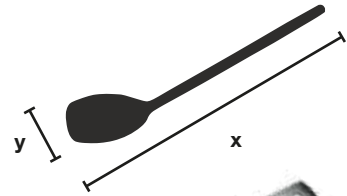

Cuchara Nylon
Nylon spoon
Cuillère Nylon
Servierlöffel Nylon

x (cm)	y (cm)	Ref.	€	
33	6,5	35381	4,03	36

INOX 18%



Cuchara ranurada Nylon
Nylon spoon
Cuillère Nylon
Gelochter servierlöffel Nylon

x (cm)	y (cm)	Ref.	€	
33	6,5	35383	4,03	36

INOX 18%



Nyloonline



Cazo Nature
Nature ladle
Louche Nature
Schöpfkelle Nature

x (cm)	y (cm)	Ref.	€	
35	9	35052	9,86	12

INOX 18%



Espumadera Nature
Nature skimmer
Écumoire Nature
Schaumlöffel Nature

x (cm)	y (cm)	Ref.	€	
35	10,5	35062	8,11	12

INOX 18%



Espátula perforada Nature
Nature perforated spatula
Spatule lisse poignée Nature
Pfannenschaufel Nature

x (cm)	y (cm)	Ref.	€	
35	8	35074	7,94	12

INOX 18%



Espátula Nature
Nature spatula
Spatule Nature
Pfannenschaufel Nature

x (cm)	y (cm)	Ref.	€	
35	10	35072	7,54	12

INOX 18%



Espátula prensador Nature
Nature pressing spatula
Palette pour presser Nature
Pressvorrichtung schaufel Nature

x (cm)	y (cm)	Ref.	€	
35	-	35042	7,54	12

INOX 18%



Cuchara Nature
Nature pressing spoon
Cuillère Nature
Servierlöffel Nature

x (cm)	y (cm)	Ref.	€	
35	7	35082	8,11	12

INOX 18%  

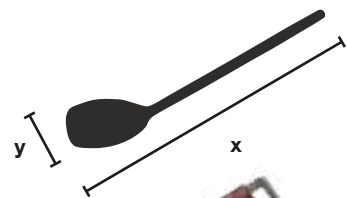

Tenedor Nature
Nature perforated fork
Fourchette Nature
Tranchiergabel Nature

x (cm)	y (cm)	Ref.	€	
35	3	35092	7,54	12

INOX 18%  



Natureline



Espátula de silicona

Silicone spatula
Spatule silicone
Silikonschaufel

x (cm)	y (cm)	Ref.	€	
21,5	4	35344	3,44	6
27,5	5,5	35345	4,32	6

100% Silicone

Cuchara de silicona

Silicone spoon
Cuillère en silicone
Silikonlöffel

x (cm)	y (cm)	Ref.	€	
27,6	5,6	35346	4,97	6

100% Silicone

Cuchara plana de silicona

Silicone flat spoon
Cuillère plate en silicone
Silikonlöffel

x (cm)	y (cm)	Ref.	€	
28,1	5,2	35347	4,64	6

100% Silicone

Espátula ranurada de silicona

Slotted silicone spatula
Spatula en silicone à fentes
Geschlitzter Silikonspatel

x (cm)	y (cm)	Ref.	€	
30,6	7,8	35348	4,97	6

100% Silicone

Espátula volteadora de silicona

Silicone spatula turner
Spatule tourneur en silicone
Silikon Spachtelwender

x (cm)	y (cm)	Ref.	€	
25,8	12	35349	6,82	6

100% Silicone

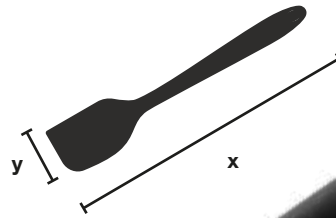
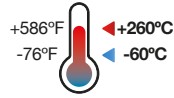
**Silicone****Espátula de silicona**
Silicone spatula
Spatule silicone
Silikonschaufel

x (cm)	y (cm)	Ref.	€	
21,5	4	35334	3,44	6
27,5	5,5	35335	4,32	6

100% Silicone

Cuchara de silicona
Silicone spoon
Cuillère en silicone
Silikonlöffel

x (cm)	y (cm)	Ref.	€	
27,6	5,6	35336	4,97	6

100% Silicone

Cuchara plana de silicona
Silicone flat spoon
Cuillère plate en silicone
Silikonlöffel

x (cm)	y (cm)	Ref.	€	
28,1	5,2	35337	4,64	6

100% Silicone

Espátula ranurada de silicona
Slotted silicone spatula
Spatula en silicone à fentes
Geschlitzter Silikonspatel

x (cm)	y (cm)	Ref.	€	
30,6	7,8	35338	4,97	6

100% Silicone

Espátula volteadora de silicona
Silicone spatula turner
Spatule tourneur en silicone
Silikon Spachtelwender

x (cm)	y (cm)	Ref.	€	
25,8	12	35339	6,82	6

100% Silicone



BPA FREE
Silicone



Cazo de silicona
Silicone ladle
Louche en silicone
Silikonkelle

x (cm)	y (cm)	Ref.	€	
29,7	8,7	35350	5,84	6

100% Silicone



Pincel de silicona
Silicone brush
Pinceau en silicone
Silikonbürste

x (cm)	y (cm)	Ref.	€	
25	4,3	35352	4,64	6

100% Silicone



Espátula plana de silicona
Flat silicone spatula
Satule plate en silicone
Flacher Siilikonspatel



x (cm)	y (cm)	Ref.	€	
32	3,5	35331	5,10	6

100% Silicone

Pincel silicona mango acero
Silicone brush steel handle
Pinceau silicone manche acier
Malerpinsel silikon

x (cm)	y (cm)	Ref.	€	
22	3,8	35341	3,49	6

INOX

Espátula silicona pequeña mango acero
Silicone spatula small steel handle
Spatule petit silicone manche acier
Silikonschaufel

x (cm)	y (cm)	Ref.	€	
22,2	3,5	35342	3,10	6

INOX

BPA FREE
Silicone

INOX

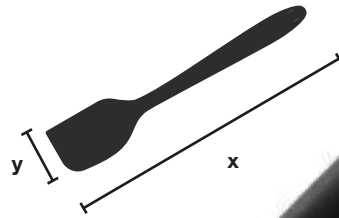
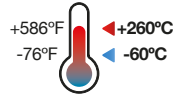

**Silicone****Cazo de silicona**
Silicone ladle
Louche en silicone
Silikonkelle

x (cm)	y (cm)	Ref.	€	
29,7	8,7	35340	5,84	6

100% Silicone

Pincel de silicona
Silicone brush
Pinceau en silicone
Silikonbürste

x (cm)	y (cm)	Ref.	€	
25	4,3	35332	4,64	6

100% Silicone

Espátula plana de silicona
Flat silicone spatula
Satule plate en silicone
Flacher Siilikonspatel

x (cm)	y (cm)	Ref.	€	
32	3,5	35330	5,10	6

100% Silicone

Espátula silicona grande mango acero
Silicone spatula big steel handle
Spatule grand silicone manche acier
Silikonschaufel

x (cm)	y (cm)	Ref.	€	
21,6	4,8	35343	4,07	6

INOX



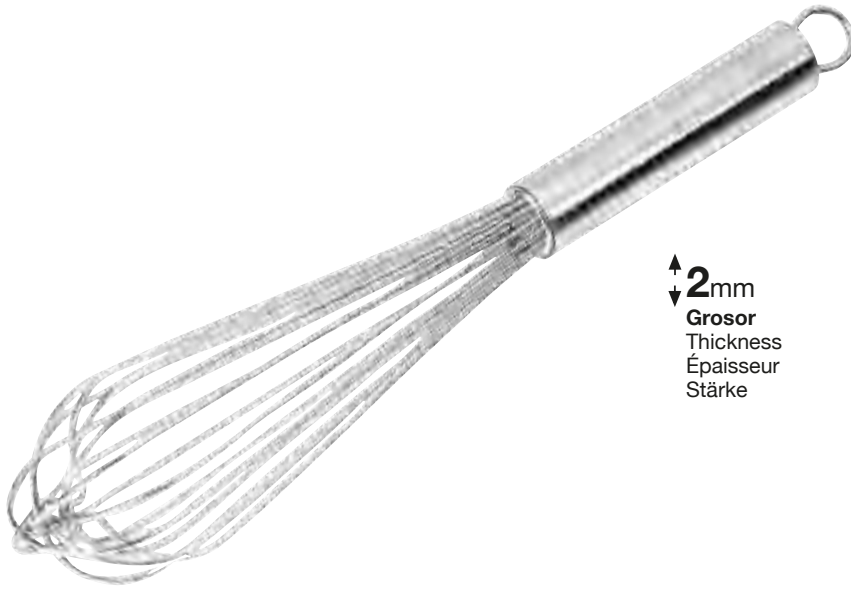

↑
↓ **2mm**
Grosor
Thickness
Épaisseur
Stärke

Batidor
Whisk
Fouet
Rührbesen

x (cm)	Ref.	€	
25	53225	11,33	50
30	53230	12,24	50
35	53235	13,02	50
40	53240	13,94	50
45	53245	15,23	-
50	53246	16,81	-
55	53247	17,93	-
60	53248	18,77	-

INOX 18/10  



↑
↓ **1,4mm**
Grosor
Thickness
Épaisseur
Stärke

Batidor
Whisk
Fouet
Rührbesen

x (cm)	Ref.	€	
25	53972	7,25	10
30	53974	8,43	10
35	53976	9,37	10
40	53978	10,49	10

INOX  



Batidor silicona mango inox
Silicona whisk inox handle
Fouet silicone manche acier
Silikonrührbesen

x (cm)	Ref.	€	
25	53995	5,95	6
30	53991	6,95	6
35	53997	7,95	24 *

INOX  

***** Color amarillo
Yellow colour





Batidor silicona
Silicone whisk



Batidor mecánico automático
Automatic mechanical egg whisk
Fouet mécanique automatique
Automatische mechanische rührbesen

x (cm)	y (cm)	Ref.	€	
25	5	53221	8,29	24
35	7	53220	8,95	10

INOX 18/10  

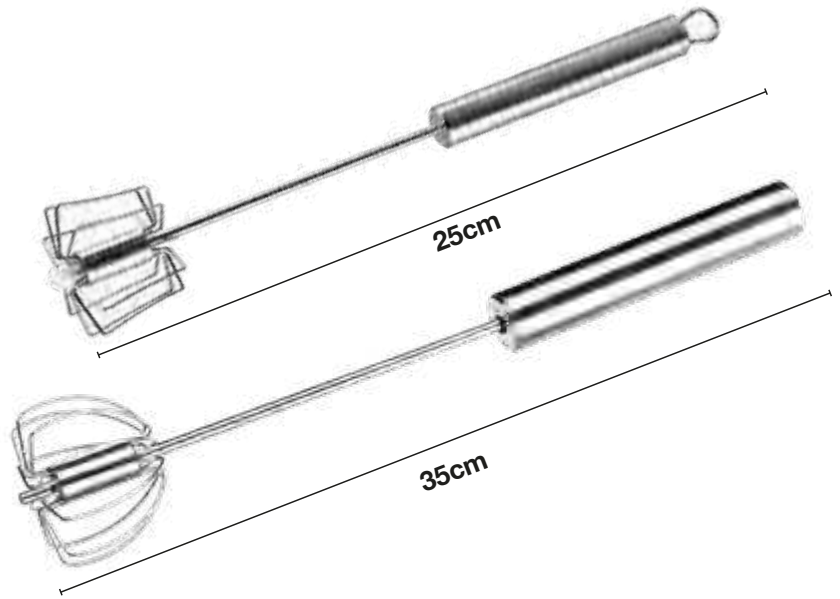

Batidor mecánico, uso manual, sin cables, no necesita ni electricidad ni batería.

Cable-free mechanical whisk for manual use, does not need electricity or battery.

Fouet mécanique, usage manuel, sans câbles, qui ne requiert ni électricité ni batterie.

Praktischer handbetriebener Quirl, ohne Stromkabel und ohne Batterie.

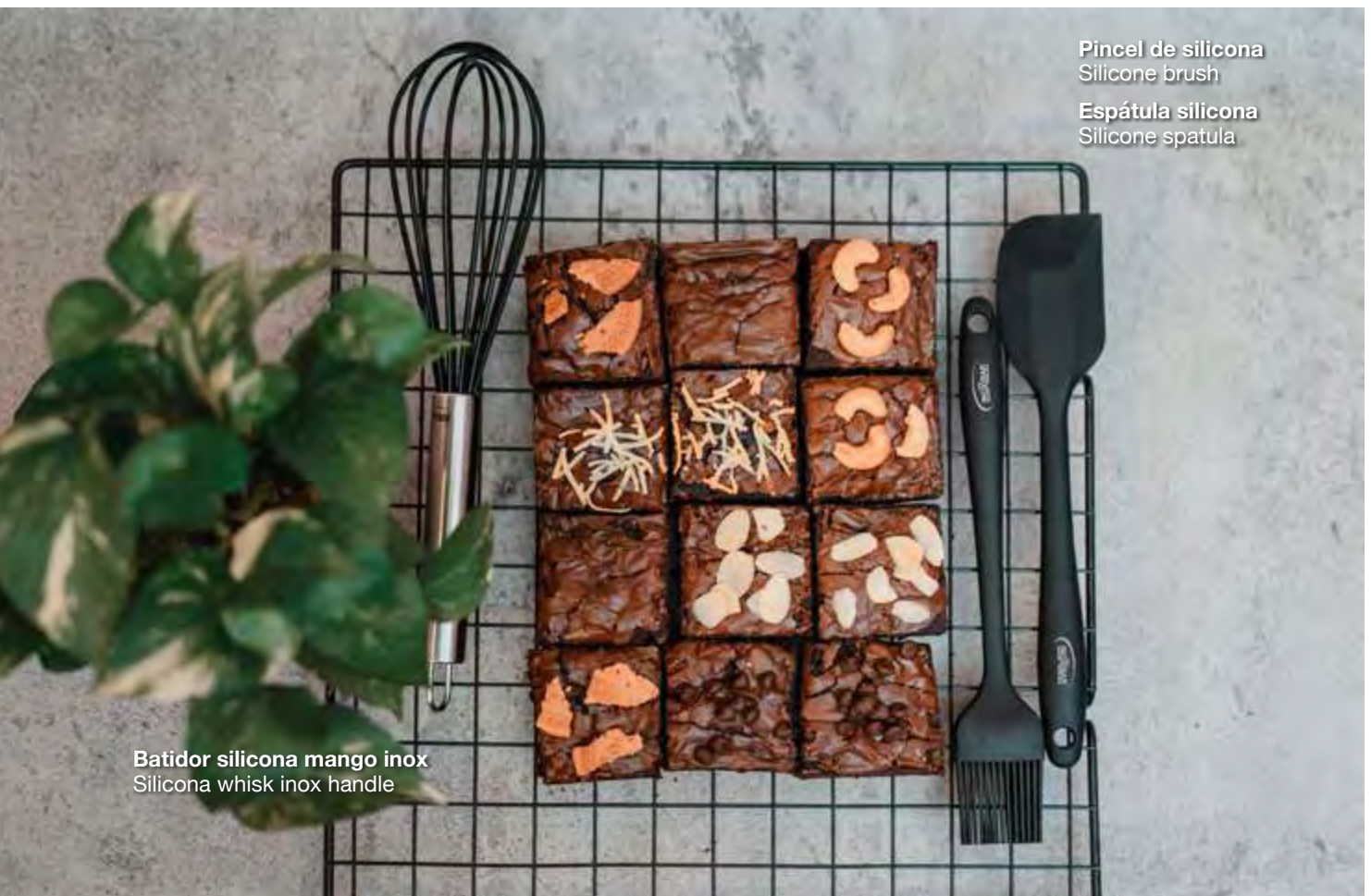

Pincel de silicona
Silicone brush

Espátula silicona
Silicone spatula

Batidor silicona mango inox
Silicone whisk inox handle



Soportesline

220



Soporte sartenes horizontal
Horizontal pan support
Support pour poêles horizontale
Waagrechtter Pfannenträger

	x (cm)	y (cm)	z (cm)	Ref.	€	
4 uds.	27	26	24	61718	30,50	10

INOX  



Soporte tablas vertical
Vertical board support
Support pour planches à découper
Senkrechte Brettauflage

	x (cm)	y (cm)	z (cm)	Ref.	€	
4 uds.	24	19,5	17	61716	14,95	6
8 uds.	40	30	27	61717	39,95	6

INOX  



Escurreidor de cubiertos
Cutlery cylinder
Panier pour porte couvert
Besteckabtropfer



Silicone

Escurreidor enrollable
Roll-up drainer
Egouttoir déroulant
Rolladen Geschirrständer

x (cm)	y (cm)	Ref.	€	
60	40	61708	34,11	-

INOX  

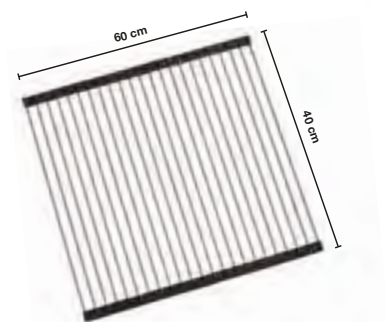
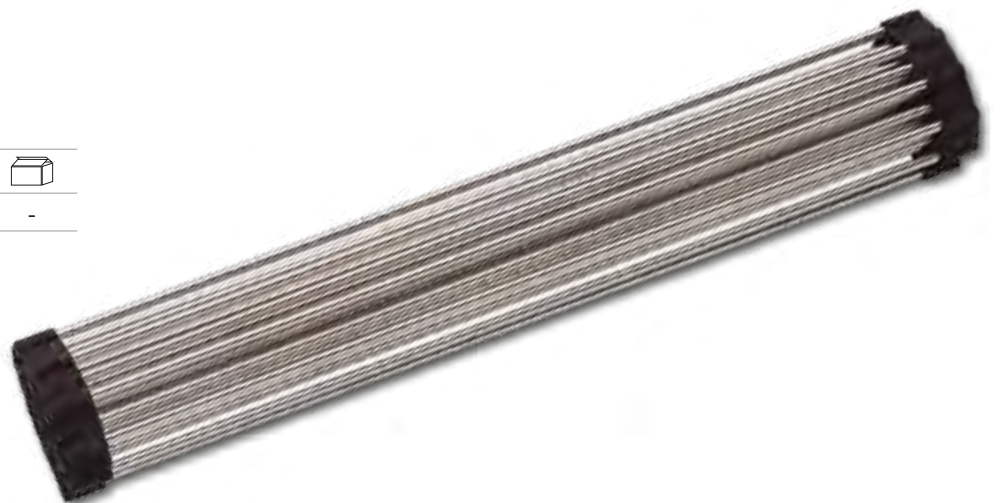



Silicona y acero inoxidable
Silicone and high stainless steel
Silicone et acier massif
Silikon und massiver stahl



Soporte pared Nylon 5

Nylon suport
Support Nylon
Wandhalterung

x (cm)	y (cm)	Ref.	€	
30	-	35321	5,79	12



INOX 18/10  



Soporte pared

Wall support
Support mural
Hängeleiste

x (cm)	y (cm)	Ref.	€	
-	-	00006	4,50	-

INOX 18/10  



Soporte de pie

Stand
Support droit
Ständer

x (cm)	y (cm)	Ref.	€	
38	13	13019	14,12	12

INOX  



Escurreidor de cubiertos
Cutlery cylinder
Panier pour porte couvert
Besteckabtropfer

Ø (cm)	H (cm)	Ref.	€	
6	10	61706	3,85	24
9	11,7	61711	6,07	24
10	12,5	61712	8,03	24
11	14	61714	9,02	24

INOX  



Reposacucharas
Spoon rest
Repose-cuillère
Löffelablage

x (cm)	y (cm)	Ref.	€	
20	10	13007	10,12	100

INOX  



Recetas sencillas para disfrutar sin bobadas

Simple recipes for simple meals

Recipes by
David de Jorge
ROBIN FOOD



Recipes

pág. 318
page 318

#pasionporlacocina

Vieiras a la gallega
Galician-style scallops
Saint-Jacques à la galicienne
Jakobsmuscheln auf galizische Art

Espeor malla 0,28mm

Wire diameter 0,28mm

Paso de malla 0,63mm

Opening 0,63mm



Colador fuerte

Strong strainer, steel handle

Passoire résistante, manche acier

Sieb stark

Ø (cm)	x(cm)	Ref.	€	
14	37	53514	19,54	24
16	40	53516	21,40	24
18	41	53518	24,12	24
20	44	53520	28,73	24
23	54	53523	31,10	24
25	57	53525	36,89	24
31	60	53531	45,56	12
36	63	53536	53,60	24

INOX 18/10  

Colador de varilla y malla

Mesh and wire strainer

Passoire fil et tamis

Netz-und Drahtsieb

Ø (cm)	x(cm)	n° patillas	Ref.	€	
8	22	2	53330	2,38	100
10	27	1	53332	3,00	100
12	28	2	53334	3,94	100
14	29	2	53336	7,47	50
16	31	2	53338	8,35	50
18	36	1	53340	9,86	50
20	38	1	53342	11,19	50
22	39	1	53344	19,78	50
25	42	1	53346	23,80	50

INOX 18/10  





Colador Professional Line S/S
Strainer Professional Line S/S
Passoire Professional Line S/S
Spitzsieb Professional Line S/S

Ø (cm)	x(cm)	Ref.	€	
24	57	53410	24,76	12
28	62	53420	27,15	12
30	68	53430	30,09	12

INOX 18/10



Colador de varilla refuerzo doble
Wire strainer double stiffener
Passoire fil double reufort
Sieb mit doppelter Verstärkung

Ø (cm)	x(cm)	Ref.	€	
14	36	53914	13,38	24
16	40	53916	17,21	24
19	44	53919	24,80	24
22	51	53922	30,40	24
25	56	53925	35,42	-

INOX 18/10



Espesor malla 0,28mm
Wire diameter 0,28mm

Paso de malla 0,63mm
Opening 0,63mm

Colador varilla y malla con soporte
Mesh and wire sieve with stand
Passoire fil et tamis à pied
Netz- und Drahtsieb mit Ständer

Ø (cm)	x(cm)	Ref.	€	
16	30	53382	10,05	50
18	33	53384	12,54	50
20	34	53386	13,78	50

INOX 18/10





Colador nido para hacer moldes
Nest sieve
Panier à nid
Nestbacklöffel zur Formengebung





***‘Diferentes formas de cocinar.
En la variedad está la riqueza’***
***‘Different ways of cooking.
In the variety is the richness’***



Colador de varilla y malla cónico
Conical mesh and wire sieve
Passoire conique fil et tamis
konisches Netz- und Drahtsieb



Ø (cm)	Ref.	€	
8	53350	4,72	100
10	53351	6,57	100
12	53352	8,47	100
14	53354	10,84	50
16	53355	12,81	50
20	53357	17,86	50

INOX 18/10  



Colador pletina pulida
Strainer steel and mesh
Passoires acier et tamis
Sieb mit poliertem Stahlrand



Ø (cm)	Ref.	€	
8	53360	4,32	100
10	53362	5,01	100
12	53364	7,44	100
14	53366	11,04	50
16	53368	12,39	50
18	53370	13,80	50
20	53372	16,52	50

INOX 18/10  



Colador recto extensible
Extensible strainer
Passoire extensible
Ausziehbares Spülbank-Sieb

x (cm)	y (cm)	Ref.	€	
35 (max 55)	25	53396	27,89	20

INOX  



Colador chino mango varilla
Cone sieve strainer rod handle
Passoire chinois manche varille
Spitzsleib mit Stangengriff



Ø (cm)	Ref.	€	
12	53056	14,95	6
18	53057	21,95	6
20	53058	24,95	6
25	53059	31,95	6

INOX



Colador nido para hacer moldes
Nest sieve
Panier à nid
Nestbacklöffel zur Formengebung

Ø (cm)	Ref.	€	
8-10	53053	16,15	30
10-12	53055	18,62	72

INOX 18/10



Colador pletina y tubo Elite
Strainer steel and tube Elite
Passoire acier et tube Elite
Sieb Flachstahl und Rohr Elite

Ø (cm)	Ref.	€	
8	53708	4,32	100
10	53710	4,96	100
12	53712	7,22	100
14	53714	10,02	50
16	53716	12,28	50

INOX 18/10



Colador
Strainer
Passoir
Durchschlag

Ø (cm)	Ref.	€	
7	53007	2,27	6
10	53010	2,94	6

INOX 18%



Todo acero
Full steel
Toutacier
Ganz aus stahl



Addline

Espátula Add Line

Add Line spatula
Spatule Add Line
Pfannenschaufel Add Line

x (cm)	Ref.	€	
23	13201	5,50	-

INOX 18%  

Espátula triangular Add line

Add Line triangular spatula
Spatule triangulaire Add Line
Spatula triangolare Add Line

x (cm)	Ref.	€	
25,5	13203	5,62	-

INOX 18%  

Espátula acodada Add Line

Add Line bent spatula
Spatule coudée Add Line
Winkelpalette Add Line

x (cm)	Ref.	€	
27	13205	5,74	-

INOX 18%  

Eliteline



Vaciador frutas Elite

Elite fruit baller
Cuillère parisienne Elite
Obstausstecher Elite

x (cm)	Ref.	€	
18	13320	6,21	-

INOX 18%  

Rizador de limón Elite

Elite lemon zester
Zesteur citron Elite
Zitronenschäler Elite

x (cm)	Ref.	€	
17,2	13322	6,10	-

INOX 18%  

Eliteline

Paleta cortaqueso Elite

Elite cheese slicer/spatula
Pelle coupe fromage Elite
Käsehobel Elite

x (cm)	Ref.	€	
21	13316	8,75	6

INOX 18%  



Paleta de servir tartas Elite

Elite cake server
Pelle a gâteau Elite
Tortenheber Elite

x (cm)	Ref.	€	
25	13318	7,30	6

INOX 18%  



Descapsulador y abrebotes Elite

Elite bottle opener
Decapsuleur Elite
Flaschenöffner Elite

x (cm)	Ref.	€	
22	13324	6,44	6

INOX 18%  



Racionador de helado Elite

Elite ice cream scoop
Cuillère a glaces Elite
Eisportionierer Elite

Ø (cm)	Ref.	€	
4,5	13366	21,29	12
5,0	13368	21,29	12
5,5	13370	21,29	12
6,0	13372	21,29	12
6,5	13374	21,29	12



INOX 18%  



Racionador de helado Elite

Elite ice cream scoop
Cuillère a glace Elite
Eisportionierer Elite

x (cm)	Ref.	€	
21,5	13312	7,73	6

INOX 18%  





Prensa ajos Elite
Elite garlic press
Presse-ail Elite
Knoblauchpresse Elite

x (cm)	Ref.	€	
20	13306	17,99	6

INOX 18%  



Cortapatatas en bastoncillos Elite
Elite potato chip cutter
Coupe-frites Elite
Pommes-schneider Elite

x (cm)	Ref.	€	
24	13330	45,15	6

INOX 18% 

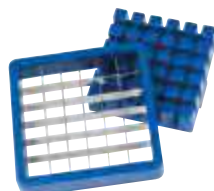

Conjunto cuchillas cortapatatas bastones
Blades set

Ref.	€	
13331	18,61	-

2 Cuchillas intercambiables
Inter changeable blades
(8 mm + 10 mm)



Con ventosa
With suction pad

Prensador Elite

Elite pressing
Presser Elite
Stampfer Elite

-	Ref.	€	
-	13344	6,97	36



INOX 



Picaperejil Elite

Elite fine herbs mincer
Hachoir à manivèle pour fines herbes Elite
Kräutermühle, fein rostfrei Elite

Ø (cm)	x (cm)	H (cm)	Ref.	€	
9	19	6	13336	19,92	6



INOX  

Desmontable, fácil de limpiar y guardar
Detachable, easy to clean and store

Colador gusanillo

Cocktail strainer
Passoire à cocktail
Cocktailsieb

x (cm)	Ref.	€	
20,5	35460	17,67	-

INOX 18/10  

Rasqueta vitro e induccion Elite

Hob Scraper Elite
Racleur pour plaque de cuisson Elite
Reinigungschaber für glaskeramik Elite



Ref.	€	
13342	7,95	20

INOX  



3 recambios incluidos
3 spare parts included



Pizzaline



Paleta de servir Elite

Elite server
Pelle Elite
Palette Elite

x (cm)	Ref.	€	
25	13318	7,30	6

INOX 18%  

Ruleta cortapizza mango baquelita

Pizza cutter bakelite handle
Roulette coupe pizza
Pizzaschneider

Ø (cm)	Ref.	€	
10	13440	8,21	12

INOX  

Paleta Pizza

Pizza spatula
Spatule pizza
Pizza Spatula

x (cm)	Ref.	€	
30	13450	9,03	12

INOX  

Bandeja de servir

Serving dish
Plat de service
Servierteller

Ø (cm)	Ref.	€	
32	18063	16,70	-

INOX 18/10  



Pala de pizza

Slice for pizza
Pelle à pizza
Pizzaschaufel

Ø (cm)	x (cm)	Ref.	€	
25,5	62	61030	19,90	-

INOX 18/10 

Mango de madera · Wooden handle
Manche en bois · Holzgriff

235



Rejilla pizza

Pizza grid
Grille à pizza
Pizza Screen

Ø (cm)		Ref.	€	
20	Pequeña / Small	61061	6,78	-

INOX 



Rallador de manivela Elite

Elite grater mill
Moulin à fromage Elite
Reibmühle Elite

x (cm)	Ref.	€	Pack
20	13332	18,18	1

INOX 18%  





Paleta
Spatula
Spatule
Spatula

a (cm)	b (cm)	c (cm)	Ref.	€	
6	11	27	13463	7,83	12

INOX  



Paleta Pizza
Pizza spatula
Spatule pizza
Pizza Spatula

a (cm)	b (cm)	c (cm)	Ref.	€	
8	12,5	30	13450	9,03	12

INOX  



Espátula triangular
Triangular spatula
Spatule triangulaire
Spatula triangolare

a (cm)	b (cm)	c (cm)	Ref.	€	
6	12,5	28	13452	6,63	12

INOX  





Espátula perforada
Perforated spatula
Spatule lisse poignée
Pfannenschaufel

a (cm)	b (cm)	c (cm)	Ref.	€	
7,5	15	33	13460	8,43	12
7,5	20	38	13461	9,27	12
7,5	25	42	13462	10,85	6

INOX

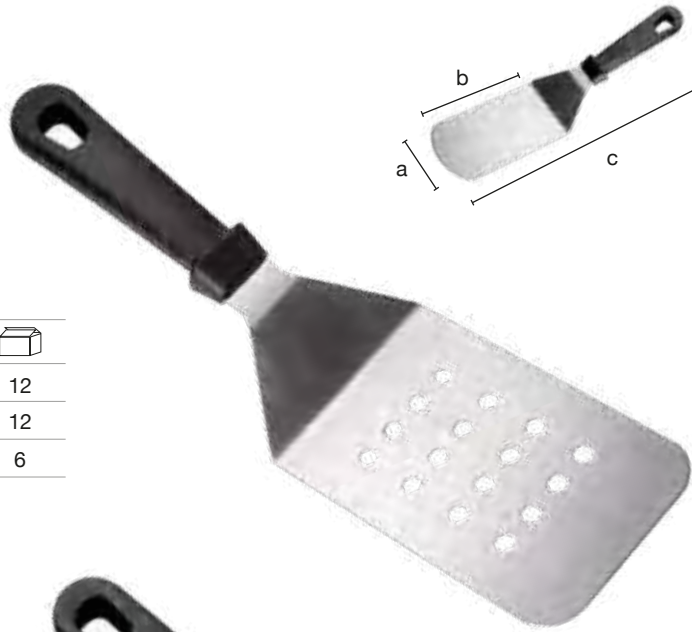
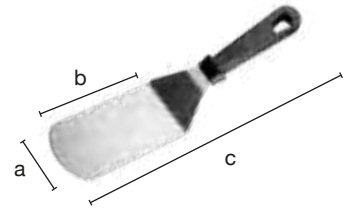

Espátula lisa
Straight spatula
Spatule lisse
Backschaufel

a (cm)	b (cm)	c (cm)	Ref.	€	
7,5	15	33	13465	8,43	12
7,5	20	38	13466	9,27	12
7,5	25	42	13467	10,85	12

INOX



Espátula larga recta
Long straight spatula
Spatule longue droite
Palette

a (cm)	b (cm)	c (cm)	Ref.	€	
3	10	21,5	13470	3,85	12
3	15	27	13472	4,82	12
3,5	20	32	13474	6,02	12
3,5	25	38	13476	7,22	12

INOX



Espátula larga acodada
Long bent spatula
Spatule longue coudée
Winkelpalette

a (cm)	b (cm)	c (cm)	Ref.	€	
3	10	25	13480	3,85	12
3	15	30	13482	6,02	12
3,5	20	37	13484	7,22	12
3,5	25	43	13486	8,43	12
3,5	30	48	13488	9,63	12

INOX



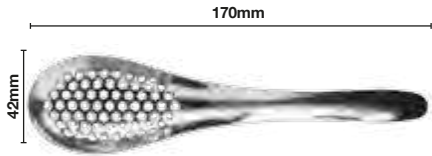

ESPECIAL PARA PROFESIONALES

Cuchara para esferificaciones
Spherification spoon
Cuillère pour sphérification
Sphärfizierung Löffel

x (cm)	Ref.	€
17	13417	5,41

INOX  



Pinza especial dentada
Special toothed tong
Pince dentée spéciale
Spezialzange mit Zähnen

x (cm)	Ref.	€	
20	13404	6,95	10

INOX 18%  



Pinza pescado
 Fish bone remover
 Pince à poisson
 Fischgrätenpinzette



x (cm)	y(cm)	Ref.	€	
13	2	53117	8,95	12

INOX



Pinza de pescado
 para retirar las espinas
 Fish bone remover

Pinza especial acero inoxidable
 Special Stainless Steel Tong
 Pince Spéciale Acier inox
 Spezialzange aus Rostfreiem Stahl

x (cm)	Ref.	€	
16	53104	3,98	36

INOX



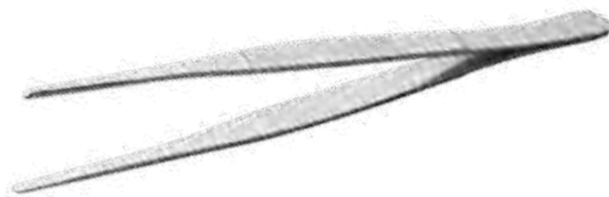

Pinza de emplatar de precisión
Precision plating tongs
Pince de présentation de précision
Vorlegezange Präzision

x (cm)	Ref.	€	
18	53116	5,35	-

INOX  

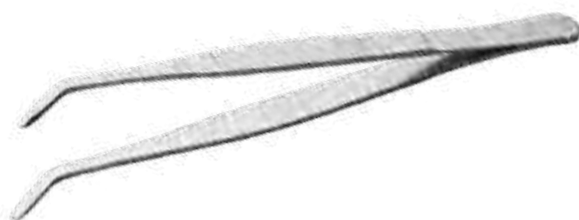

Pinza de emplatar punta curva
Curved plating tongs
Pince de présentation coudée
Vorlegezange gebogene Spitze

x (cm)	Ref.	€	
18	53113	5,35	-

INOX  



Pinza de emplatar acodada
Cranked plating tongs
Pince de présentation pointe courbée
Vorlegezange gebogen

x (cm)	Ref.	€	
20	53112	5,35	-

INOX  







Pinzas servir

Tong-fork-spoon
Pince
Zange

x (cm)	Ref.	€	
18	13412	10,43	6

INOX 18/10  



Tenedor y cuchara de servir

Tong-fork-spoon
Pince à fourchettes
Clamp Gabel

x (cm)	Ref.	€	
18	13410	9,28	12



INOX 18/10  



Pinzas ensalada

Salad tong
Pince à salade
Salat Zange

x (cm)	Ref.	€	
26,5	13402	18,01	6

INOX 18/10  



Pinzas repostería

Cake tong
Pince à gateaux
Kuchen tong

x (cm)	Ref.	€	
20	13406	10,65	6

INOX 18/10  







Pinza grill Nylon
Nylon tipped Grill tongs
Pince Grill pointes nylon
Grillzange Nylongreifer

x (cm)	Ref.	€	
30	53630	6,51	12
35	53635	7,55	12

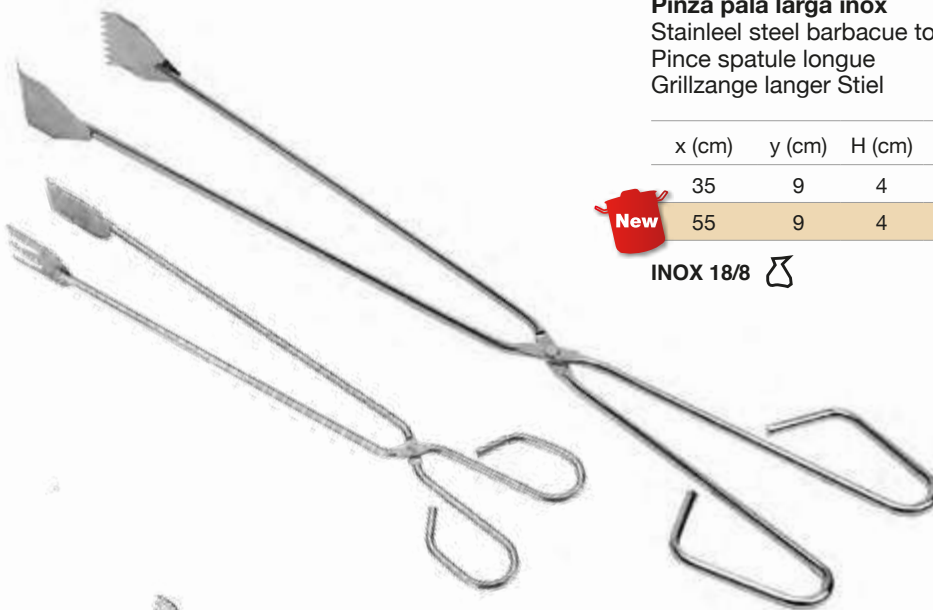
INOX  



Pinza pala larga inox
Stainless steel barbecue tong
Pince spatule longue
Grillzange langer Stiel

x (cm)	y (cm)	H (cm)	Ref.	€	
35	9	4	53640	5,67	6
55	9	4	53641	13,75	6

 New

INOX 18/8 

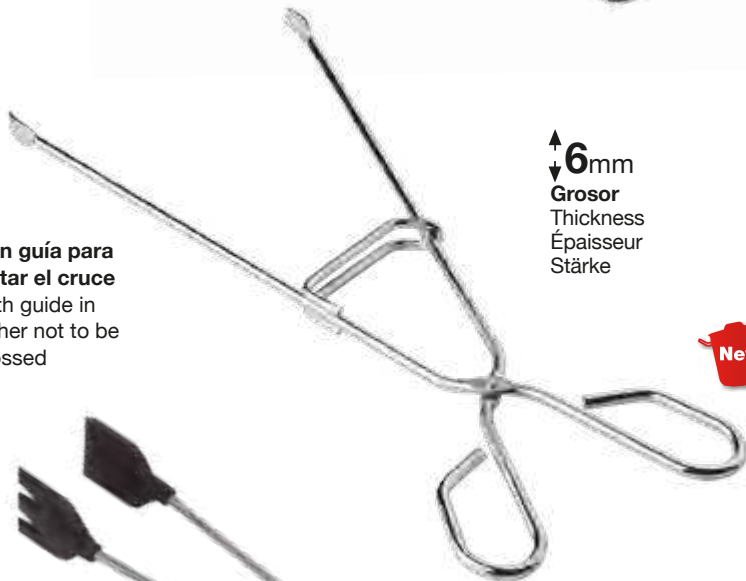

↑
6mm
↓
Grosor
Thickness
Épaisseur
Stärke

Con guía para evitar el cruce
With guide in order not to be crossed

Pinza profesional con guía
Stainless steel fish grill
Pince professionnelle avec guide
Profi-Zange mit Schiene

x (cm)	y (cm)	H (cm)	Ref.	€	
33	10	1,5	53645	16,02	6
45	10	1,5	53646	22,95	6

 New

INOX 18/8 



Pinza pala silicona 35
Stainless steel tong with silicone scoop 35
Pince spatule silicone 35
Zange mit silikongreifer 35

x (cm)	y (cm)	H (cm)	Ref.	€	
35	9	4	53643	7,85	6

INOX 



Pinza barbacoa

All stainless steel barbecue tongs
Pince barbecue tout inox
Grillzange

x (cm)	Ref.	€	
25	53725	4,83	10
30	53730	5,51	10
35	53735	6,88	100

INOX 18%



Pinzas espagueti

Spaguetti glass
Pinze spaguetti
Spaghetti-Zange

x (cm)	y (cm)	Ref.	€	
23	6	53100	7,87	-

INOX 18/10



Pinza hielo

Ice tong
Pince à glace
Eiszange

Sin muelle · Without spring · Sans ressort · Ohne feder

x (cm)	Ref.	€	
17	53101	6,06	-

INOX 18/10



Sin muelle · Without spring

Con muelle · With spring · Avec ressort · Mit feder

x (cm)	Ref.	€	
17	53110	3,13	100

INOX



Con muelle + abridor · With spring + bottle opener
Avec ressort + decapsuleur · Mit feder + Flaschenöffner

x (cm)	Ref.	€	
17	53111	3,75	200

INOX



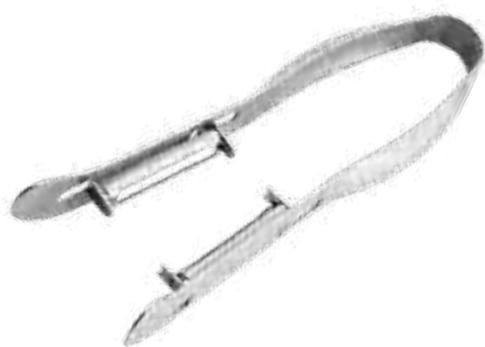

Pelador de verdura de corte doble
 Double cut vegetable peeler
 Éplucheur double
 Doppel Sparschäler

Ref.	€	
13418	7,56	6

INOX



Pelador de patatas transversal
 Cross section potato peeler
 Éplucheur coupe transversale
 Kartoffelschäler

Ref.	€	
13420	6,87	6

INOX 18%



Cascanueces
 Nutcracker
 Casse noisette
 Nussknacker

x (cm)	Ref.	€	
15	13345	12,66	36

INOX 18%



Dos posiciones: Vertical u horizontal
 Two positions: Vertical or horizontal

Portarrollos multifunción
 Multifunctional kitchen-roll holder
 Porte-Rouleaux multifonctions
 Mehrfunktions-Rollenhalter

Ø (cm)	H (cm)	Ref.	€	
17	28,5	61050	28,92	6

INOX 18%

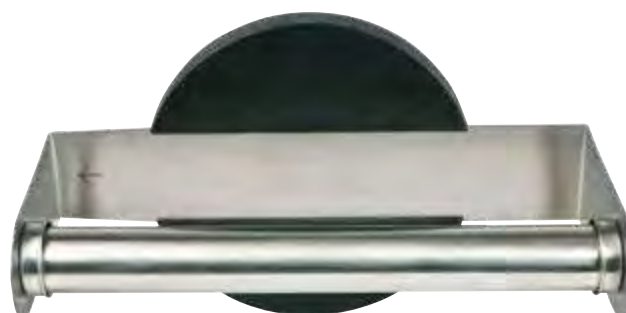

Mesa

Tableware

La table

Tisch



Soperas y legumbreras, bandejas, catering...

Soup tureens and vegetable bowls, platters and trays...

Soupières et légumiers, plats, catering...

Suppen und Gemüseschüsseln, Tablett, Catering...



Cateringline

246



Set rectangular de catering con cúpula
Catering set rectangular tray with lid
Set plat rectangulaire traiteur avec couvercle
Rechteckig set catering-tablet mit deckel

x (cm)	y (cm)	H (cm)	Ref.	€	
43	27	17	07010	43,35	3

INOX 18% 

Bandeja catering
Catering tray
Plat traiteur
Catering-tablett

x (cm)	y (cm)	Ref.	€	
43	27	59249	9,89	20

INOX 18% 

Campana rectangular catering
Catering rectangular lid
Couvercle rectangulaire traiteur
Rechteckig deckel catering-tablet

x (cm)	y (cm)	Ref.	€	
43	27	59248	32,79	-





Set portatapas con cúpula
Tapas tray with lid
Plat pour tapas avec couvercle
Tapas platte mit deckel

INOX 18/10

INOX 18%

x (cm)	y (cm)	Ref.	€	
21	15	18092	30,12	-
21	15	59092	27,32	-





Set catering con cúpula
Catering set tray with lid
Set plat traiteur avec couvercle
Set catering-tablet mit deckel

Ø (cm)	H (cm)	Ref.	€	
35	9,5	07000	28,91	3

INOX 18%

Bandeja catering circular
Circular catering tray
Plat traiteur circulaire
Rund catering-tablet

Ø (cm)	Ref.	€	
35	59252	9,46	-

INOX 18%

Campana circular catering
Catering circular lid
Couvercle traiteur circulaire
Rund deckel catering

Ø (cm)	H (cm)	Ref.	€	
30	9,5	59251	18,51	20

Cúpula
Lid
Couvercle
Deckel

x (cm)	y (cm)	Ref.	€	
21	15	59254	17,73	-
31	21	59014	32,88	20
36	26	59016	37,16	20
39	31	59018	39,40	20



Compatibles con Llaunas, bandejas y rustideras
Compatible with Llaunas, dishes and roasting tins

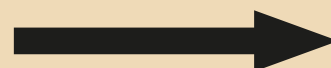



Se presenta con papel parafinado para el contacto con los alimentos

It is presented with parchment paper for contact with the food

Base madera

Wood base
Socle en bois
Holzsockel

x (cm)	y (cm)	H (cm)	Compatible con piezas	Ref.	€		*
28,5	18,5	1,8	21x15cm	18056	21,95	-	*
40	25,5	1,8	30x21cm	18057	36,95	-	*

Natural pine Wood

Para recipientes de 30x21cm y 21x15cm
For recipients of 30x21cm and 21x15cm

INOX 18%

Bandeja rectangular

Rectangular dishe
Plat rectangulaire
Tablett rechteckig

x (cm)	ext (cm)	H (cm)	Ref.	€		*
21x15	24,0 x 16,2	1,3	55028	7,54	-	*
30x21	37,0 x 22,2	1,5	59015	14,63	-	*
35x26	40,2 x 28,2	1,6	59017	16,37	-	
40x31	42,2 x 32,2	1,8	59019	20,10	-	

INOX 18%

Bandeja 'Llauna'

Steel Baking tray
Plaque de cuisson en acier
Backblech aus Stahl

int (cm)	ext (cm)	H (cm)	Ref.	€		*
21x15	24,0 x 16,2	2,5	59043	8,48	10	*
30 x 21	37,0 x 22,2	2,5	59045	14,15	10	*
35 x 26	40,2 x 28,2	2,5	59047	17,14	10	
40 x 31	42,2 x 32,2	2,5	59049	21,23	6	

INOX 18%

Rustidera rectangular asa monobloc

Rectangular roasting tin monobloc handle
Plat à gratin rectangulaire poignée monobloc
Bratform rechteckig Griffrand

int (cm)	ext (cm)	H (cm)	Ref.	€		*
18 x 13	21,8 x 14,2	3	59089	8,27	15	
21x15	24,0 x 16,2	3,5	59091	10,32	10	*
30 x 21	37,0 x 22,2	5,5	59095	17,04	10	*
35 x 26	40,2 x 28,2	5,5	59097	21,53	10	
40 x 31	42,2 x 32,2	6	59099	27,76	6	

INOX 18%





Base madera para proteger y vestir la mesa en platos calientes, fríos y presentaciones

Wooden base to protect and dress the table in hot, cold dishes and presentations

Made in SPAIN

Compatibles con Llaunas, bandejas y rustideras
Compatible with Llaunas, dishes and roasting tins



249

INOX 18/10

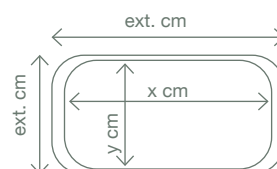

Bandeja 'Llauna'
Steel Baking tray
Plaque de cuisson en acier
Backblech aus Stahl

int (cm)	ext (cm)	H (cm)	Ref.	€		
21x15	24,0 x 16,2	2,5	18043	9,73	10	*
30 x 21	37,0 x 22,2	2,5	18045	19,68	10	*
35 x 26	40,2 x 28,2	2,5	18047	25,03	10	
40 x 31	42,2 x 32,2	2,5	18049	28,66	6	



INOX 18/10

Rustidera rectangular asa monobloc
Rectangular roasting tin monobloc handle
Plat à gratin rectangulaire poignée monobloc
Bratform rechteckig Griffband

int (cm)	ext (cm)	H (cm)	Ref.	€		
21x15	24,0 x 16,2	3,5	18091	12,79	10	
30 x 21	37,0 x 22,2	5,5	18095	23,18	10	*
35 x 26	40,2 x 28,2	5,5	18097	30,69	10	*
40 x 31	42,2 x 32,2	6	18099	39,85	6	





INOX 18/10

Dosificador uso múltiple
Multi purpose dispenser



Especiero dosificador Line uso múltiple
Line Multi-purpose dispenser
Line Doseur multi-usage
Gewürzdose/Streuer multifunktional

	Ref.	€	
1 unidad	61036	6,52	-
12 u /Display	61037	77,37	-

INOX 18/10 



Without



Small



Especieros
Spice jars
Pots à épices
Gewürzdose

Para hierbas y simil sin agujeros
For herbs and the like, without holes
Pour herbes et similaires sans trous
Für Kräuter usw. Ohne Löcher

Ø (cm)	H (cm)	Ref.	€	
9,5	7	53201	13,01	-

Con agujeros pequeños
With small holes
Avec petits trous
Fein gelocht

Ø (cm)	H (cm)	Ref.	€	
9,5	7	53202	13,01	-

Con agujeros medianos
With medium holes
Avec trous moyens
Mittelgross gelocht

Ø (cm)	H (cm)	Ref.	€	
9,5	7	53203	13,01	-

Con agujeros grandes
With large holes
Avec gros trous
Gross gelocht

Ø (cm)	H (cm)	Ref.	€	
9,5	7	53204	13,01	-

INOX 18/10 

250

Medium



Large

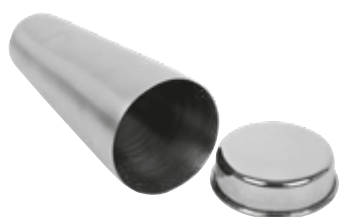

Con tapa. De fácil limpieza
With lid. Easy to clear
Avec couvercle. Facile d'entretien
Mit deckel leicht zu reinigen



Salero Duende Moninox
Salt shaker Duende
Salière Duende
Salzstreuer Duende

Ø (cm)	Ref.	€	Pack
10,5 x 4	61038	4,55	1

INOX 



Molinillo individual
 Individual mill
 Individuel moulin
 Einzel Pfeffermühlen

H (cm)	Ref.	€	
14	61023	20,13	20

INOX 18/10 





Set 6 platos Ø 13 cm

6 bill plate without clip Ø 13 cm
6 Plat pour monnaie Ø 13 cm
6 Platte Ø 13 cm ohne klemmvorrichtung

Ø (cm)	Ref.	€	
13	53063	13,05	40

INOX



Platillo para pan

Bread and butter plate
Petite assiette pour le pain
Brotteiler

Ø (cm)	Ref.	€	
14	18064	4,40	-

INOX 18/10



Set de 6 posavasos

Glass stand
Sous-verre
6 Glasuntersetzer

Ø (cm)	Ref.	€	
10,5	53061	11,44	-

INOX 18%



Set de 6 posabotellas/ plato cambios

Coaster
Dessous de bouteille
6 Flaschenuntersetzer/Münztablett

Ø (cm)	Ref.	€	
13	53062	14,06	-

INOX 18%

252



Bandeja ración 13 x 14 cm

Snack tray 13 x 14 cm
Assiette tapas 13 x 14 cm
Platte für tapas 13 x 14 cm

x (cm)	y (cm)	Ref.	€	
13	14	53067	8,29	10

INOX



Plato para servir

Serving dish
Plat de service
Servierteller

Ø (cm)	Ref.	€	
14	56003	2,99	-
16	56007	3,22	-

INOX 18%



Set de 6 rabaneras

Appetizer dish
Ravier
6 Vorspeisenplatte

x (cm)	y (cm)	Ref.	€	
13	6	56061	11,79	-
17	8	56063	13,00	-
20	10	56065	14,30	-

INOX 18%



Platillos Ø 13 cm con pinza

Bill plate with clip Ø 13 cm
Plat pour monnaie a pince Ø 13 cm
Platte Ø 13 mit klemmvorrichtung

Ø (cm)	Ref.	€	
13	53064	2,45	200

INOX

Cogedor-rasqueta

Breadcrumb scraper
Ramasse-miettes
Krümsammler/Schaber

x (cm)	y (cm)	Ref.	€	
-	-	61020	6,75	60

INOX

Bandeja portafactura con pinza

Rectangular bill tray with clip
Porte addition rectangulaire a pince
Platte mit klemmvorrichtung

x (cm)	y (cm)	Ref.	€	
17	10,5	59007	4,89	10

INOX

Bandeja cambio y portafactura

Bill and tips tray
Plateau monnaie et porte-facture
Rechnungs-Münztablett

x (cm)	y (cm)	Ref.	€	
21	14	59006	5,76	-

INOX 18%

Bandeja bajo-plato acero

Underplate tray, S.S
Assiette de présentation, acier
Platzteller Stahl

Ø (cm)	H (cm)	Ref.	€	
32	1,5	18063	16,70	

INOX 18/10



INOX 18%

**Bandeja oval borde vuelto**

Oval dish out-turned edge

Ovale plat bord rabattu

Buffet-Tablet oval

x (cm)	y (cm)	Ref.	€	
20	13	59068	4,15	-
25	17	59070	6,00	-
30	20	59072	6,58	-
35	24	59074	8,15	-
40	27	59076	9,98	-
45	29	59078	11,56	-
50	31	59080	14,28	-
70	45	59054	35,39	-
80	48	59056	41,05	-

INOX 18% **Bandejas de pescado**

Special dimension dishes

Plats dimensions spéciales

Tabletts Sondermaße

x (cm)	y (cm)	Ref.	€	
60	27	59082	20,12	-
80	30	59084	25,22	-

INOX 18% 

INOX 18/10



Bandeja oval borde vuelto

Oval dish out-turned edge
Ovale plat bord rabattu
Buffet-Tablet oval

x (cm)	y (cm)	Ref.	€	
20	13	18068	6,15	-
25	17	18070	7,84	-
30	20	18072	9,81	-
35	24	18074	12,16	-
40	27	18076	16,19	-
45	29	18078	18,50	-
50	31	18080	22,20	-

INOX 18/10 



Bandejas de pescado

Special dimension dishes
Plats dimensions spéciales
Tabletts Sondermaße

x (cm)	y (cm)	Ref.	€	
60	27	18082	27,19	-
80	30	18084	37,16	-

INOX 18/10 



INOX 18%

Bandeja redonda, borde vuelto
Round tray, out-turned edge
Plat rond, bord rabattu
Rundtablett Rundrand

Ø (cm)	Ref.	€	
30	59060	7,95	-
35	59062	9,98	-

INOX 18% 



Bandeja camarero, borde vuelto
Waiter tray, out-turned edge
Plateau de service, bord rabattu
Serviertablett

Ø (cm)	H (cm)	Ref.	€	
40	2,5	59088	15,51	-

INOX 18% 



Fuente circular honda
Deep round dish
Plat rond profond
Flache runde schüssel

Ø (cm)	H (cm)	Ref.	€	
26	5	59187	10,65	-
32	5,5	59188	12,76	-
36	6	59189	17,09	-
40	6,5	59190	20,22	-

INOX 18% 

 **Certificado internacional de calidad** · International quality certificate
Certificat international de qualité · Internationales Qualitätzertifikat



Bandeja Fiberglass no-deslizante
Fiberglass tray, non-slip
Plateau Fibre de verre, antiglisse
Fiberglass-tablett, Rutschfest

x (cm)	y (cm)	Ref.	€	
35	27	59290	11,04	-





INOX 18/10

Bandeja redonda, borde vuelto
Round tray, out-turned edge
Plat rond, bord rabattu
Rundtablett Rundrand

Ø (cm)	Ref.	€	
30	18060	11,74	-
35	18062	15,75	-

INOX 18/10 



Bandeja camarero, borde vuelto
Waiter tray, out-turned edge
Plateau de service, bord rabattu
Serviertablett

Ø (cm)	H (cm)	Ref.	€	
40	2,5	18088	24,52	-

INOX 18/10 



Fuente circular honda
Deep round dish
Plat rond profond
Flache runde schüssel

Ø (cm)	H (cm)	Ref.	€	
26	5	18187	16,61	-
32	5,5	18188	20,46	-
36	6	18189	27,19	-
40	6,5	18190	30,88	-

INOX 18/10 



Indeformable, más resistente
Undeformable, more resistant

Bandeja Fiberglass no-deslizante
Fibreglass tray, non-slip
Plateau Fibre de verre, antiglisse
Fiberglass-tablett, Rutschfest

Ø (cm)	Ref.	€	
35,5	59280	12,36	-
40	59282	16,22	-





Jarra zumo con visor lateral
 Juice jug with side level indicator
 Carafe a jus de fruits avec niveau visible
 Saftkanne mit seitlicher messskala

Ø (cm)	H (cm)	L	Ref.	€	
12	13	1	55108	25,74	12

INOX 18/10 



Jarra de agua
 Water jugs · Pots à eau · Wasserkanne

Sin retenedor · Without retainer ·
 Sans bec filtrant · Ohne Siebeinsatz

Ø (cm)	H (cm)	L	Ref.	€	
12	20	2	55103	30,39	16

Con retenedor · With retainer
 Abec filtrant · Mit Siebeinsatz

Ø (cm)	H (cm)	L	Ref.	€	
12	20	2	55104	33,31	16

INOX 18/10 

Sopera con base

Soup Tureen with stand
Soupière à pied
Suppensschüssel mit Fussreif

Ø (cm)	H (cm)	L	Ref.	€	
20	10	2,5	50131	19,44	20
22	11	2,5	50231	21,21	20
24	12	3	51261	22,67	11
28	14	5	51285	27,93	6

INOX 18/10



Sopera sin base

Soup Tureen without stand
Soupière sur pied
Suppensschüssel ohne Fussreif

Ø (cm)	H (cm)	L	Ref.	€	
22	10	2,5	50246	18,24	14

INOX 18/10



Legumbreira

Vegetable bowl
Légumier
Servierschüssel

Ø (cm)	H (cm)	L	Ref.	€	
14	5,5	0,6	50014	12,29	12
16	7	1	50016	12,88	8
20	7	2	50037	15,51	8
22	7,5	2	50237	16,74	20
24	8	3	51267	18,68	20
28	9	4,5	51287	25,02	15

INOX 18/10



Bolset

Bolset
Bolset
Schüssel

Ø (cm)	L	Ref.	€	
12	0,33	53120	8,63	-
21	2	99077	15,81	-

INOX 18/10



Ensaladera

Salad bowl
Saladier
Salatschüssel

Ø (cm)	H (cm)	L	Ref.	€	
20	4,5	1,5	61220	17,03	10
22	4,5	1,5	61222	17,9	10
24	4,8	2	61224	20,28	10

INOX 18/10



Silicona y acero · Silicone and steel
Silicone et acier · Silikon und stahl



Salvamantelesline



Máxima calidad. Ligero y fácil de guardar
Ahorro de espacio
Highest quality. Light and easy to keep
Saves space

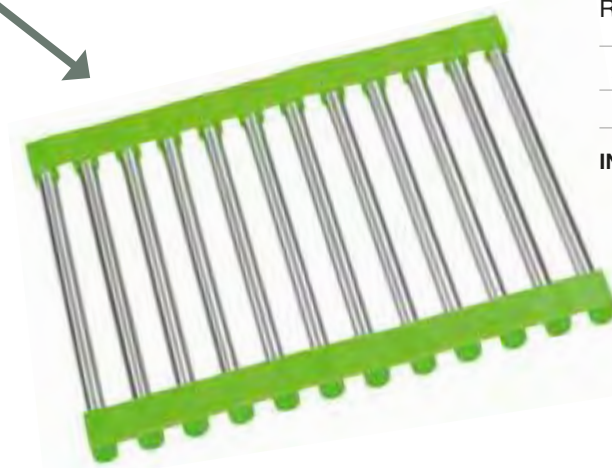

Salvamantel enrollable
Roll-up trivet
Sous-plat déroulant
Rolladen topfgitter

x (cm)	y (cm)	Ref.	€	
20	23	18051	11,87	18

INOX 

260

Utilizarse como protector
Use it like a protector



Transportar ollas y sartenes calientes
Transport hot pots and pans



Magnetizado
Magnetized



Salvamanteles extensible

Extendible trivet
Sous-plat extensible
Ausziehbaren topfgitter

x (cm)	y (cm)	Ref.	€	
22 - 26	20	18053	14,27	20

INOX 

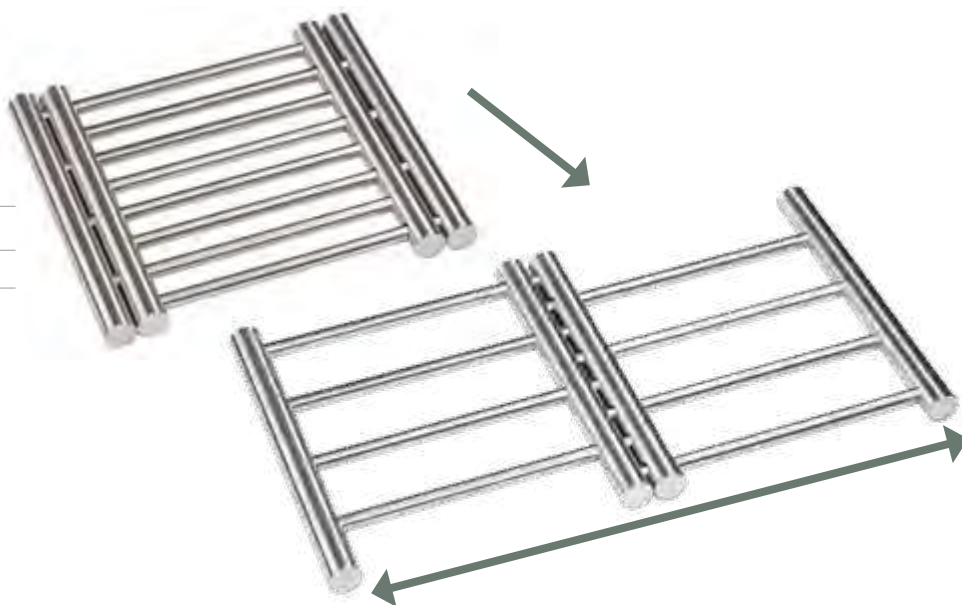

261



Silicone

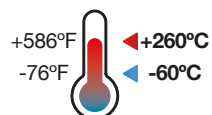

Set de 2 salvamanteles imantados

Set of 2 magnetized trivets
Set 2 sous-plats magnetiques
Set 2 magnetischer untersetzer

Ø (cm)	Ref.	€	
20	18055	14,13	-

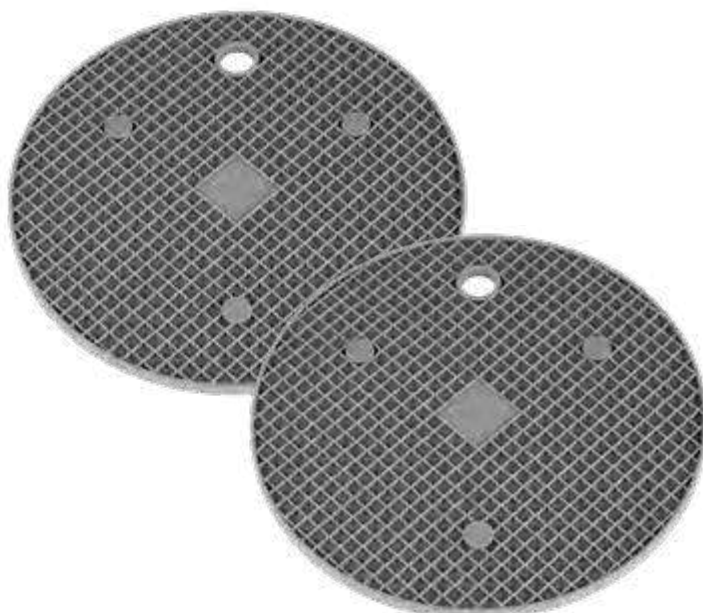



Servilleterosline

262



Servilletero cóctel
Napkin rack cocktail
Porte-serviettes cocktail
Servilletenhalter cocktail

	x (cm)	y (cm)	H (cm)	Ref.	€	
NEGRO	12	12	7	61234	17,55	24
BLANCO	12	12	7	61235	17,55	24

Pine wood/DMF 

Servilletero cubo
Cube napkin-holder
Porte-serviettes de table cube
Serviettenhalter cube

	x (cm)	y (cm)	H (cm)	Ref.	€	
NEGRO	10	11	15	61232	21,95	6
BLANCO	10	11	15	61233	21,95	6

Pine wood 

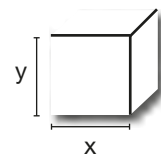

Servilletero alto
Tall napkin-holder
Porte-serviettes de table haut
Serviettenhalter hoch

x (cm)	y (cm)	H (cm)	Ref.	€	
18,5	18,5	20	61240	10,50	-

INOX 18% 

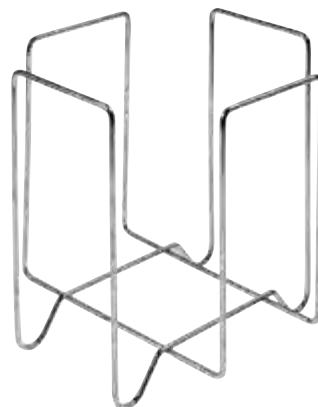

Servilletero bajo
Low napkin-holder
Porte-serviettes de table bas
Serviettenhalter niedrig

x (cm)	y (cm)	H (cm)	Ref.	€	
17	17	6	61230	15,45	-

INOX 18% 

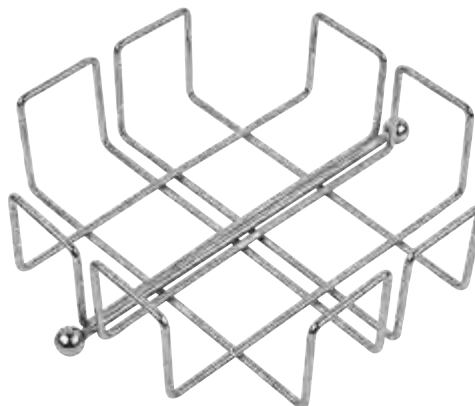

Servilletero individual
Individual napkin rack
Porte-serviettes individuel
Servilletenhalter

-	Ref.	€	
-	61231	2,95	-

INOX 18% 





Set aceite y vinagrera
 Vinegar and oil set stand
 Huile et vinaigrier support
 Oil und essig stütze

Ø (cm)	H (cm)	Ref.	€	
7	28	00009	9,12	48

INOX 18/10 



264



 **Antigoteo**
 Anti-drip

Aceitera antigoteo
 Anti-drip oil dispenser
 Huilier anti-goutte
 Tropffreier Ölspender

Ø (cm)	H (cm)	L (ml)	Ref.	€	
6	20	300	61326	7,95	-
6,5	23,5	500	61328	8,35	-

Vidrio 
 Glass



Bar

Barware

Le café bar

Bar



Cafetería, cóctel, bandejas, bodega...

Coffee set, cocktail, trays, wineware...

Cafétéria, cocktail, plats, cave...

Kaffee, cocktail, tablett, keller...

Cafeteríaline



Cafetera Express
Expres coffe pot
Cafetière Express
Kaffemaschine Express

	L	Ref.	€	
4 tazas	200ml	55040	53,22	4
6 tazas	300ml	55041	59,95	4
10 tazas	500ml	55042	75,95	4

INOX 18/10



New



- Resistente al calor
- Fácil de limpiar
- Libre 100% de PFOA y NMP
- Temperature resistant exterior
- Easy to clean
- 100% free of PFOA or NMP



Cafetera Express BLACK
Expres BLACK coffe pot
Cafetière Express BLACK
Kaffemaschine Express BLACK



New

	L	Ref.	€	
4 tazas	200ml	55043	55,45	4
6 tazas	300ml	55044	64,45	4
10 tazas	500ml	55045	80,45	4

INOX 18/10



Cafetera Express Easy
Expres Easy coffe pot
Cafetière Express Easy
Kaffemaschine Express Easy

	L	Ref.	€	
6 tazas	300ml	55071	55,45	8
10 tazas	500ml	55072	66,08	4

INOX 18/10



Fácil de limpiar
Easy to clean





Cafetera Express Eros
Expres Eros coffe pot
Cafetière Express Eros
Kaffemaschine Express Eros

	L	Ref.	€	
6 tazas	300ml	55073	55,45	12
10 tazas	500ml	55074	66,08	12

INOX 18/10



267

		€
Dos juntas de silicona cafetera 4 tazas Two Silicone ring for 4-cup coffeepot Deux joint en silicone pour cafetière 4 tasses Zwei Silikondichtung kaffeemaschine 4 Tassen	55054	1,8
Dos Juntas de silicona cafetera 6 tazas Two silicone ring for 6-cup coffeepot Deux joint en silicone pour cafetière 6 tasses Zwei Silikondichtung Kaffeemaschine 6 Tassen	55055	2,11
Dos juntas de silicona cafetera 10 tazas Two silicone ring for 10-cup coffeepot Deux joint en silicone pour cafetière 10 tasses Zwei Silikondichtung Kaffeemaschine 10 Tassen	55056	2,34





268



Tetera Glas
Glass teapot
Théière Glass
Teekanne Glass

L	Ref.	€	
0,6	55231	34,35	-
1,20	55261	42,42	-

INOX 18/10 

**Colador para Infusiones con tapa**

Strainer to Infusions with lid

Passoire pour Infusions avec couvercle

Teesieb mit Deckel

Ø cm	H (cm)	Ref.	€	
7,7	12	13413	15,18	-

INOX 18/10



Tapa especial para usar como plato
Special lid to use like a plate



Tetera Professional Line
Professional Line teapot
Théière Professional Line
Teekanne Professional Line

L	Ref.	€	
0,125	55080	16,00	-
0,25	55180	21,61	-
0,35	55280	26,49	-
0,60	55380	30,65	-

INOX 18/10 



Cafetera Professional Line
Professional Line coffepot
Cafetière Professional Line
Kaffeekanne Professional Line

L	Ref.	€	
0,25	55050	21,78	-
0,35	55150	26,70	-
0,60	55250	29,26	-
0,90	55350	34,72	-

INOX 18/10 



Azucarero Professional Line
Professional Line sugar bowl
Sucrier Professional Line
Zuckerdose Professional Line

L	Ref.	€	
0,125	55085	19,74	-
0,5	55185	23,36	-

INOX 18/10 



Lechera Professional Line
Professional Line milkpot
Pot à lait Professional Line
Milchkännchen Professional Line

L	Ref.	€	
0,125	55010	11,38	-
0,25	55110	16,29	-
0,35	55210	22,16	-
0,60	55220	25,10	-
0,90	55230	29,24	-

INOX 18/10 



CLASSIC

Lechera Professional Classic
Milkpot Professional Classic
Pot à lait Professional Classic
Milchkanne Professional Classic

L	Ref.	€	
0,1	55410	7,25	-
0,2	55420	8,45	-
0,3	55430	10,9	-
0,6	55440	15,21	-
0,9	55450	18,12	-
1,5	55460	27,37	-
2	55470	31,80	-

INOX 18/10



Con medidor interior · With inside meter
600 ml · 900 ml · 1500 ml · 2000 ml



271

Lechera Professional Classic
Milkpot Professional Classic
Pot à lait Professional Classic
Milchkanne Professional Classic

L	Ref.	€	
0,6	55441	20,38	-
0,6	55442	20,38	-
0,9	55451	23,32	-
0,9	55452	23,32	-

White

Black

White

Black

INOX 18/10



Professionaline



Cubitera profesional
Professional ice bucket
Seau à glace professionnel
Profi-Eiswürfelbehälter

Ø (cm)	H (cm)	L	Ref.	€	
28	18	10	59211	61,20	-

INOX 18/10

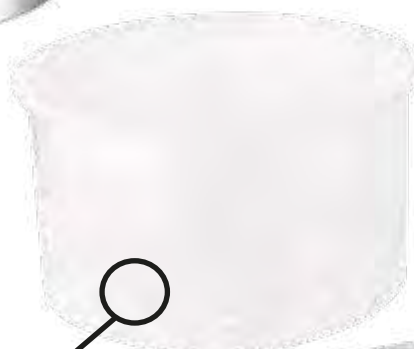
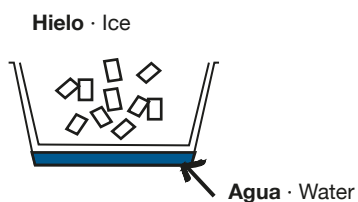

272



Champanero semiesférico con base
Champagne cooler
Refrâchisseur à champagne
Champagnerkühler halbrund

Ø (cm)	H (cm)	L	Ref.	€	
28	16	7	67629	61,93	-
32	18	10	67633	76,08	-

INOX 18/10

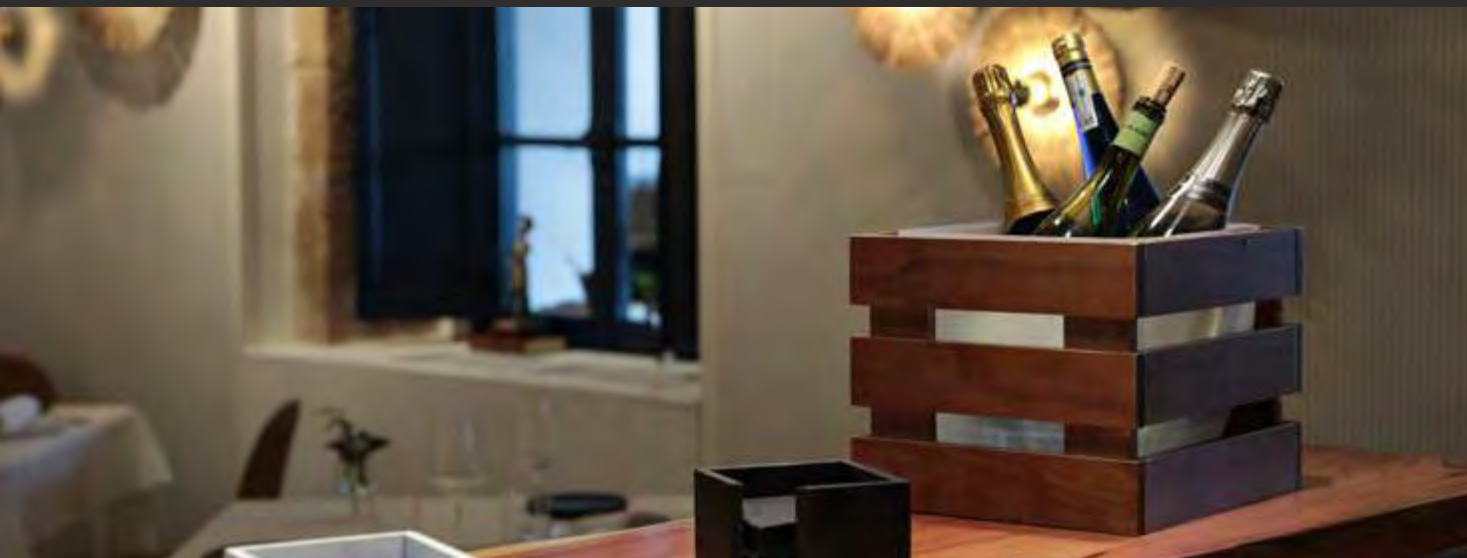

Cubitera y rejilla
Ice bucket and grid
Seau a glace et grille
Eiskübel und Lochdeckel

	x (cm)	y (cm)	z (cm)	L	Ref.	€	
BLANCO	44,5	32	23	20	59152	124,95	1
NEGRO	44,5	32	23	20	59155	124,95	1

Pine wood
HDPE (Polietileno de alta densidad)



sin rejilla
without grid

	x (cm)	y (cm)	z (cm)	L	Ref.	€	
BLANCO	31	27,5	23	10	59151	77,95	1
NEGRO	31	27,5	23	10	59154	77,95	1
MADERA	31	27,5	23	10	59157	77,95	1

Pine wood
Polypropylene
Methacrilate



	x (cm)	y (cm)	z (cm)	L	Ref.	€	
BLANCO	24,3	21,7	19,5	5,5	59150	47,95	1
NEGRO	24,3	21,7	19,5	5,5	59153	47,95	1

Pine wood
Polypropylene
Methacrilate



Cubitera y rejilla
Ice bucket and grid

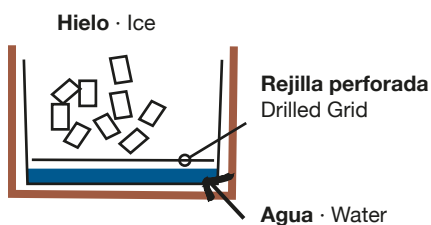



Cubo de champán
Champagne bucket
Seau à champagne
Champagnerkühler

Ø (cm)	H (cm)	L	Ref.	€	
18	19,5	4,5	59105	32,67	-

Rejilla · Grid · Grille · Gitter für Eiskübel

Ø (cm)	H (cm)	L	Ref.	€	
18	-	-	59107	11,29	-

INOX 18/10 



274

Cubitera y rejilla
Ice bucket and grid
Seau a glace et grille
Eiskübel und Lochdeckel

Ø (cm)	H (cm)	L	Ref.	€	
12	13	1,25	59103	28,65	-

INOX 18/10 



Cubitera de hielos · Ice bucket · Seau a glace · Eiskübel

Ø (cm)	H (cm)	L	Ref.	€	
12	13	1,25	59101	20,61	-

INOX 18/10 

Rejilla · Grid · Grille · Gitter für Eiskübel

Ø (cm)	H (cm)	L	Ref.	€	
12	-	-	59102	8,05	-

INOX 18/10 

Peana portacubos
 Champagne bucket pedestal
 Porte seau à champagne
 Sektkühlerständer

Ø (cm)	H (cm)	Ref.	€	
18	65	59106	84,93	-

INOX 18/10 



Soporte mesa para cubo champagne, varilla
 Tabletop rod stand for champagne bucket
 Support table pour seau au champagne
 Tischhalterung für Sektkühler

Ø (cm)	x (cm)	Ref.	€	
18	65	59117	30,62	-

INOX 18/10 



Soporte mesa + Cubo de champán
 Tabletop rod stand + Champagne bucket





Recipiente apto para el congelador
Container for the freezer



Set 8 cubitos + Pinza

Set 8 cubes + Tong

Set 8 glaçons + Pince

Set 8 Kühlwürfel + Eiszange

unidad	unidades	Ref.	€	
26 x 26 mm	8	53108	33,94	-

INOX 18/10

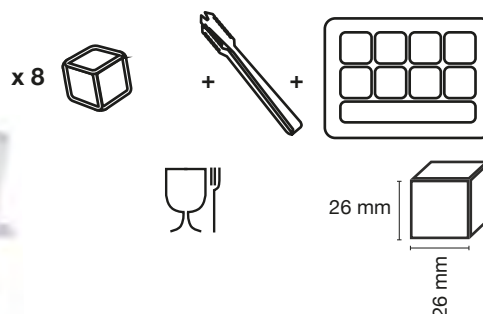

!!!Enfrían cualquier bebida sin alterar su sabor!!!
They cool any beverage without altering its flavour!!!

276



Set 6 cubitos

unidad	unidades	Ref.	€	
26x26mm	6	53109	19,95	-

INOX 18/10

Set 6 cubitos + Pinza

Set 6 cubes + Tong

Set 6 glaçons + Pince

Set 6 Kühlwürfel + Eiszange

unidad	unidades	Ref.	€	
26 x 26 mm	6	53107	23,86	-

INOX 18/10

Cubito de acero inoxidable

Stainless steel cube

Glaçon en acier inoxydable

Kühlwürfel aus edelstahl

unidad	unidades	Ref.	€	
26 x 26 mm	1	53106	3,52	12

INOX 18/10



Set de 4 cucharillas de cóctel rizada

4 Twisted bar spoon
4 Cuillère cocktail cannelée
4 Gewellter barlöffel

L	Ref.	€	
28	13405	14,12	-

INOX 



Colador de gusanillo

Cocktail strainer
Passoire à cocktail
Cocktailsieb

y (cm)	Ref.	€	
20,5	35460	17,67	-



INOX 18/10 



Colador

Strainer
Passoir
Durchschlag

Ø (cm)	Ref.	€	
7	53007	2,27	6
10	53010	2,94	6

INOX 18%  

Todo acero
Full steel
Toutacier
Ganz aus stahl



277

Pinza para hielo

Ice tong
Pince à glace
Eiszange

Sin muelle · Without spring · Sans ressort · Ohne feder

x (cm)	Ref.	€	
17	53101	6,06	-

INOX 

Sin muelle · Without spring

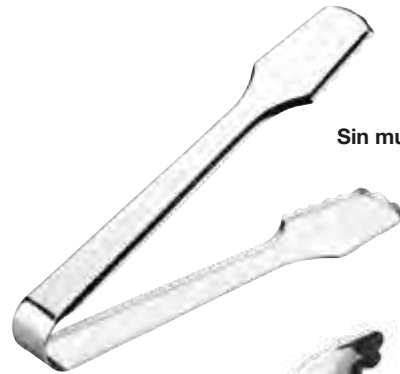

Con muelle · With spring · Avec ressort · Mit feder

x (cm)	Ref.	€	
17	53110	3,13	100

INOX 



Con muelle + abridor · With spring + bottle opener
Avec ressort + decapsuleur · Mit feder + Flaschenöffner

x (cm)	Ref.	€	
17	53111	3,75	200

INOX 





Sacacorchos de camarero bouquet, 2 tiempos
 Waiter's corkscrew, 2 time
 Tire-bouchon limonadier, 2 temps
 Kellner-Korkenzieher

x (cm)	Ref.	€	
-	35422	3,62	-

INOX 



Sacacorchos camar. Bouquet, 2/T
 Bouquet Waiter's double-lever Corkscrew, Stainless Steel
 Tire-bouchon limonadier. Bouquet, 2 leviers, Acier Inox
 Kellnermesser Bouquet, 2/T, Edelstahl

x (cm)	Ref.	€	
-	35425	4,67	-

INOX 18% 



Sacacorchos camar. Bouquet con Abrebot
 Bouquet Waiter's Corkscrew W/ Bottle Opener
 Tire-bouchon limonadier Bouquet avec Décapsuleur
 Kellnerkorkenzieher Bouquet mit Flaschenöffner

x (cm)	Ref.	€	
-	35427	3,43	-

INOX 



Descapsulador y abrebotos Elite
 Elite bottle opener
 Decapsuleur Elite
 Flaschenöffner Elite

x (cm)	Ref.	€	
22	13324	6,44	-

INOX 18% 



Sacacorchos bouquet
 Bouquet corkscrew
 Tire-bouchon bouquet
 Kellnermesser bouquet

-	Ref.	€	
-	35415	13,52	-

Cromo 

Bomba de vacío y 2 tapones para botella
 Wine vacuum sealer with 2 caps
 Pompe à vide pour bouteille avec 2 bouchon
 Weinpumpe mit 2 Verschlüssen

y (cm)	Ref.	€	
-	35429	7,59	-

INOX 

Dos tapones para vacío
 Two bottle caps
 Deux bouchons pour bouteille
 Zwei Vakuumstopfen

	Ref.	€	
-	35432	4,69	-



2 tapones para vacío
 2 bottle caps



Descapsulador bouquet de botellas
 Foil cutter
 Coupe capsule
 Foliencutter

	Ref.	€	
-	35420	4,99	-





Tapon bouquet, antigoteo bouquet
 Bouquet stopper, drip proof bouquet
 Bouchon bouquet, anti-gouttes bouquet
 Antitropf-verschluss bouquet

	Ref.	€	
Champagne	35437	3,75	-
Wine	35439	3,75	-

INOX 



Anillo antigoteo bouquet
 Drip-stop ring bouquet
 Collier anti-gouttes bouquet
 Tropfring bouquet

H (cm)	Ref.	€	
1,4	35441	2,30	-

INOX 





Escanciador bouquet antigoteo
Bouquet drip proof pourer
Bec Verseur bouquet anti-gouttes
Antitropf-ausgiesser bouquet

x (cm)	Ref.	€	
-	35435	1,53	-

INOX



Aireador de vino
Wine aerator
Aerateur a Vin
Wein Belüfter

x (cm)	Ref.	€	
-	35442	4,29	-

280



Boquilla servidora 1
Pourer 1
Bec Verseur 1
Flaschenausgieber 1

Ref.	€	
35443	3,80	-

INOX



Boquilla servidora 2
Pourer 2
Bec Verseur 2
Flaschenausgieber 2

Ref.	€	
35444	3,80	-

INOX



Boquilla servidora 3
Pourer 3
Bec Verseur 3
Flaschenausgieber 3

Ref.	€	
35445	3,86	-

INOX



Cubitera profesional, fuente circular honda, escanciador bouquet antigoteo y champanero semiesférico con base
Professional ice bucket, deep circular fountain, non-drip bouquet pourer and hemispherical champagne shaker with base



Servilleterosline

282

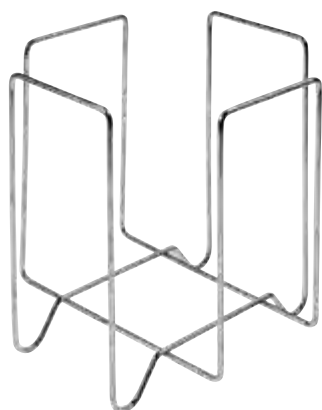

Servilletero alto
Tall napkin-holder
Porte-serviettes de table haut
Serviettenhalter hoch

x (cm)	y (cm)	H (cm)	Ref.	€	
18,5	18,5	20	61240	10,50	-

INOX 18% 

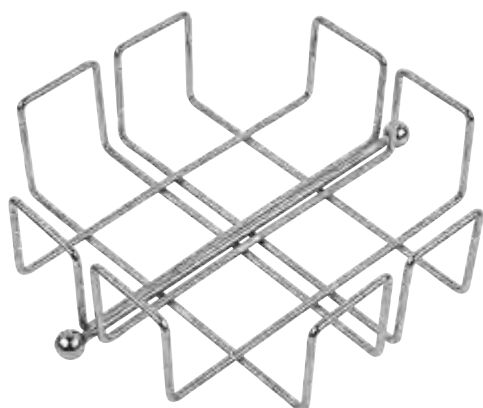

Servilletero bajo
Low napkin-holder
Porte-serviettes de table bas
Serviettenhalter niedrig

x (cm)	y (cm)	H (cm)	Ref.	€	
17	17	6	61230	15,45	-

INOX 18% 

**Servilletero cubo**

Cube napkin-holder
Porte-serviettes de table cube
Serviettenhalter cube

	x (cm)	y (cm)	H (cm)	Ref.	€	
NEGRO	10	11	15	61232	21,95	6
BLANCO	10	11	15	61233	21,95	6

Pine wood 

**Servilletero cóctel**

Napkin rack cocktail
Porte-serviettes cocktail
Servillettenhalter cocktail

	x (cm)	y (cm)	H (cm)	Ref.	€	
NEGRO	12	12	7	61234	17,55	24
BLANCO	12	12	7	61235	17,55	24

Pine wood/DMF 



Para servilletas de 10x10cm
For 10x10cm napkins



INOX 18%

Bandeja redonda, borde vuelto

Round tray, out-turned edge
Plat rond, bord rabattu
Rundtablett Rundrand

Ø (cm)	Ref.	€	
30	59060	7,95	-
35	59062	9,98	-

INOX 18% 



Bandeja camarero, borde vuelto

Waiter tray, out-turned edge
Plateau de service, bord rabattu
Serviertablett

Ø (cm)	H (cm)	Ref.	€	
40	2,5	59088	15,51	-

INOX 18% 



Fuente circular honda

Deep round dish
Plat rond profond
Flache runde schüssel

Ø (cm)	H (cm)	Ref.	€	
26	5	59187	10,65	-
32	5,5	59188	12,76	-
36	6	59189	17,09	-
40	6,5	59190	20,22	-

INOX 18% 

 **Certificado internacional de calidad** · International quality certificate
Certificat international de qualité · Internationales Qualitätzertifikat



Bandeja Fiberglass no-deslizante

Fiberglass tray, non-slip
Plateau Fibre de verre, antiglisse
Fiberglass-tablett, Rutschfest

x (cm)	y (cm)	Ref.	€	
35	27	59290	11,04	-



INOX 18/10

Bandeja redonda, borde vuelto

Round tray, out-turned edge
Plat rond, bord rabattu
Rundtablett Rundrand

Ø (cm)	Ref.	€	
30	18060	11,74	-
35	18062	15,75	-

INOX 18/10 



Bandeja camarero, borde vuelto

Waiter tray, out-turned edge
Plateau de service, bord rabattu
Serviertablett

Ø (cm)	H (cm)	Ref.	€	
40	2,5	18088	24,52	-

INOX 18/10 



Fuente circular honda

Deep round dish
Plat rond profond
Flache runde schüssel

Ø (cm)	H (cm)	Ref.	€	
26	5	18187	16,61	-
32	5,5	18188	20,46	-
36	6	18189	27,19	-
40	6,5	18190	30,88	-

INOX 18/10 



Indeformable, más resistente
Undeformable, more resistant

Bandeja Fiberglass no-deslizante

Fibreglass tray, non-slip
Plateau Fibre de verre, antiglisse
Fiberglass-tablett, Rutschfest

Ø (cm)	Ref.	€	
35,5	59280	12,36	-
40	59282	16,22	-







Bandeja catering circular

Circular catering tray
Plat traiteur circulaire
Rund catering-tablet

Ø (cm)	Ref.	€	
35	59252	9,46	-

INOX 18% 

Set catering con cúpula

Catering set tray with lid
Set plat traiteur avec couvercle
Set catering-tablet mit deckel

Ø (cm)	H (cm)	Ref.	€	
35	9,5	07000	28,91	3

INOX 18% 

Campana circular catering

Catering circular lid
Couvercle traiteur circulaire
Rund deckel catering

Ø (cm)	H (cm)	Ref.	€	
30	9,5	59251	18,51	20



286



Set rectangular de catering con cúpula

Catering set rectangular tray with lid
Set plat rectangulaire traiteur avec couvercle
Rechteckig set catering-tablet mit deckel

x (cm)	y (cm)	H (cm)	Ref.	€	
43	27	17	07010	43,35	3

INOX 18% 

Bandeja catering

Catering tray
Plat traiteur
Catering-tablett

x (cm)	y (cm)	Ref.	€	
43	27	59249	9,89	20

INOX 18% 

Campana rectangular catering

Catering rectangular lid
Couvercle rectangulaire traiteur
Rechteckig deckel catering-tablet

x (cm)	y (cm)	Ref.	€	
43	27	59248	32,79	-





Set portatapas con cúpula

Tapas tray with lid
Plat pour tapas avec couvercle
Tapas platte mit deckel

x (cm)	y (cm)	Ref.	€	
21	15	18092	30,12	-
21	15	59092	27,32	-

INOX 18/10

INOX 18%



Cúpula
Lid
Couvercle
Deckel

x (cm)	y (cm)	Ref.	€	
21	15	59254	17,73	-
31	21	59014	32,88	20
36	26	59016	37,16	20
39	31	59018	39,40	20



Compatibles con Llaunas, bandejas y rustideras
Compatible with Llaunas, dishes and roasting tins

Bandeja rectangular
Rectangular dishe · Plat rectangulaire
Tablett rechteckig

x (cm)	y (cm)	H (cm)	Ref.	€	
21	15	1,3	55028	7,54	-
30	21	1,5	59015	14,63	-
35	26	1,6	59017	16,37	-
40	31	1,8	59019	20,10	-

INOX 18% 



287



Kit especial rebozados
Battering kit
Kit à enrober
Panierset

x (cm)	y (cm)	Ref.	€	
21	15	59271	32,10	6

INOX 18% 



Set de 3 fuentes para tapas
Set of 3 snack trays
Set 3 assiettes à tapas
Satz 3 platte für tapas

x (cm)	y (cm)	Ref.	€	
18	13	59272	26,00	6

INOX 18% 



288



Pizarra pared con marco

Wall-mounted blackboard wall with frame
Tableau mural avec cadre
Wandtafel mit Rahmen

x (cm)	y (cm)	Ref.	€	
54	74	59351	48,95	10

DMF 



Pizarra de pie doble reversible

Double reversible standing blackboard
Tableau noir double réversible
Wende-Doppelstehbrett

x (cm)	y (cm)	z (cm)	Ref.	€	
55	66	101	59352	111,95	1

DMF 

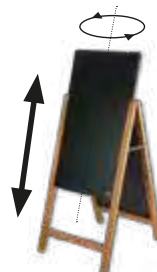

Tablero reversible
Reversible blackboard

Outdoor

Outdoor
Outdoor
Outdoor



Thermos, camping...

Thermos, camping...

Thermos flasks, camping sets...



Thermokannen, camping...

ThermoCan

Fresh	Terra	Monto	Sport Nora	Coffee and Tea	100% ecologic	Acqua	Outdoors	Sea	Rojo	Acero	Pulpo
-------	-------	-------	------------	----------------	---------------	-------	----------	-----	------	-------	-------



Capacidad

150 ml	280 ml	330 ml	500 ml	700 ml
	x			
	x		x 	
	x		x 	
	x		x	x
	x		x	
	x		x	
			x	
			x	
			x	x
			x	x
	x		x	
				x

Termos

Sólidos
Líquidos

Sólidos

Serie
Talia

Serie
Diana

ThermoDrink

Cream

Black&White

Thermo
Joy

Thermo
Can



Capacidad

150 ml	280 ml	330 ml	500 ml	700 ml
		X		
	X			
			X	
			X	
			X	

350 ml	500 ml	750 ml	800 ml	1000 ml
X	X			
X	X	X		X
	X		X	
	X			X

ThermoDrink



BLACK&WHITE

ThermoDrink Black

Ø (cm)	L	Ref.	€	
7	0,50	61179	15,24	24

INOX



ThermoDrink White

Ø (cm)	L	Ref.	€	
7	0,50	61177	15,24	24

INOX



Cream

ThermoDrink Cream

Ø (cm)	L	Ref.	€	
7	0,50	61158	15,24	24

INOX



Caja-Display
Display-Box



INOX



12h

24h



ESP

- Termo fabricado en acero inoxidable.
- Libre de BPA.
- Doble pared. Acero inoxidable 18/10 en el interior.
- Tapón estanco; con relieve para facilitar la apertura.
- Disponible en color blanco mate, en negro mate y en crema mate.
- Tamaño 500 ml.
- Lavar a mano, no apto para el lavavajillas.

ENG

- Thermo manufactured in stainless steel.
- BPA free
- Double wall. Stainless steel 18/10 inside.
- Sealed and embossed cap for easy opening.
- Handwasher only.
- Available in matt white colour, matt black colour and matt cream colour.
- 500 ml capacity.



Outdoor · Outdoor · Outdoor · Outdoor

280ml

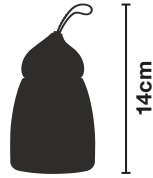

Termo Joy Yellow 280 ml

Ø (cm)	L	Ref.	€	
9	0,28	61181	16,39	-

INOX 18/10



Venta individual
Individual sale

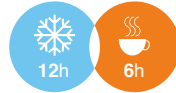

Termo Joy Aurum 280 ml

Ø (cm)	L	Ref.	€	
9	0,28	61189	16,39	-

INOX 18/10



Venta individual
Individual sale



294

ThermoJoy

Termo Joy Blue and Pink 280 ml

Ø (cm)	L	Ref.	€		
9	0,28	61180	16,39	3	3 Blue
9	0,28	61187	16,39	3	3 Pink



3 + 3

3 Blue
3 Pink



3 Pink

3 Blue



330ml

Baby Thermocan

Ø (cm)	L	Ref.	€	
7	0,33	61209	14,70	12



ThermoCan

Especial porta papillas. Incluye cuchara
Special baby food carrier. Spoon included



Outdoor · Outdoor · Outdoor · Outdoor

295



Especial bebés
Special Baby

ThermoCanline

Termos para líquidos y sólidos, que mantienen el calor 12h y el frío 6h, con doble pared de acero inoxidable, boca especial de silicona.

Flasks for liquids and solids that stay hot for 12 hours and cold for 6, with double stainless steel sides and a special silicone mouth.

280ml



Thermocan Pulpo



Thermocan Sea



Thermocan Outdoors



Thermocan Terra



Thermocan Acqua

500ml



Thermocan Love



Thermocan 100% Ecologic



Thermocan Sea



Thermocan Coffee and Tea



Thermocan Outdoors

700ml



Thermocan Fresh



Thermocan Sea

ThermoCan



INOX 18/10



Pedido mínimo, en caja expositora de 6 unidades
Minimum order, in display box of 6 units

Personalizable *
Customizable



500ml

280ml
Thermocan
Acero *



500ml

280ml
Thermocan
Rojo *

330ml



Baby Thermocan

Especial bebés
Special baby



Thermocan
Terra



Thermocan
Acqua



Thermocan
Monto Black



Thermocan
Monto Red



Thermocan
Sport



Thermocan
Monto Black



Thermocan
Monto Red



Thermocan
Sport

280ml ThermoCan



Thermocan Acqua

Ø (cm)	L	Ref.	€	
7	0,28	61183	15,28	12



Thermocan Pulpo

Ø (cm)	L	Ref.	€	
7	0,28	61213	15,28	12



Thermocan Terra

Ø (cm)	L	Ref.	€	
7	0,28	61161	15,28	12



Thermocan Sea

Ø (cm)	L	Ref.	€	
7	0,28	61169	15,28	12



Thermocan Outdoors

Ø (cm)	L	Ref.	€	
7	0,28	61190	15,28	12





INOX 18/10



**Pedido mínimo,
en caja expositora
de 6 unidades**

Minimum order,
in display box of 6 units



Thermocan acero



	Ø (cm)	L	Ref.	€	
New	7	0,28	61203	15,28	12



Thermocan rojo



	Ø (cm)	L	Ref.	€	
New	7	0,28	61204	15,28	12



¡Personaliza tu ThermoCan!

(consulta con nuestra red comercial)

Personalize your ThermoCan!

(contact with our comercial department)



ThermoCanline

ThermoCan 500ml



Thermocan Coffee and Tea

Ø (cm)	L	Ref.	€	
7	0,50	61215	17,57	12



Thermocan Outdoors

Ø (cm)	L	Ref.	€	
7	0,50	61198	17,57	12



Thermocan Acqua

Ø (cm)	L	Ref.	€	
7	0,50	61185	17,57	12



Thermocan Terra

Ø (cm)	L	Ref.	€	
7	0,50	61164	17,57	12



Thermocan Love

Ø (cm)	L	Ref.	€	
7	0,50	61206	17,57	12



Thermocan 100% Ecologic

Ø (cm)	L	Ref.	€	
7	0,50	61199	17,57	12





INOX 18/10



**Pedido mínimo,
en caja expositora
de 6 unidades**

Minimum order,
in display box of 6 units



*** ¡Personaliza tu ThermoCan!
(consulta con nuestra red comercial)
Personalize your ThermoCan!
(contact with our comercial department)**



Thermocan Sport Nora

Ø (cm)	L	Ref.	€	
7	0,50	61157	17,57	12



Thermocan acero

Ø (cm)	L	Ref.	€	
7	0,50	61201	17,57	12



Thermocan rojo

Ø (cm)	L	Ref.	€	
7	0,50	61202	17,57	12



Outdoor · Outdoor · Outdoor

301



Thermocan Sea

Ø (cm)	L	Ref.	€	
7	0,50	61168	17,57	12



Thermocan Monto Black

Ø (cm)	L	Ref.	€	
7	0,50	61211	17,57	12



Thermocan Monto Red

Ø (cm)	L	Ref.	€	
7	0,50	61162	17,57	12



ThermoCanline

ThermoCan 700ml

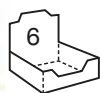

Pedido mínimo, en caja expositora de 6 unidades

Minimum order, in display box of 6 units



Thermocan Sea

Ø (cm)	L	Ref.	€	
7	0,70	61167	18,60	12



Thermocan Sport Nora

Ø (cm)	L	Ref.	€	
7	0,70	61163	18,60	12



Thermocan Fresh

Ø (cm)	L	Ref.	€	
7	0,70	61207	18,60	12



Thermocan Monto Black

Ø (cm)	L	Ref.	€	
7	0,70	61212	18,60	12



Thermocan Monto Red

Ø (cm)	L	Ref.	€	
7	0,70	61160	18,60	12





INOX 18/10



Outdoor · Outdoor · Outdoor · Outdoor

303

ThermoCanline



500ml

800ml



Termo fiabrera sólidos
Thermo for solid food
Thermo pour aliments solides
Thermobehälter mit Einsätzen

L	Ref.	€	
0,5	61135	28,30	-
0,8	61136	30,65	-

INOX 18/10



Termo fiabrera para sólidos
Thermo for solid food
Thermo pour aliments solides
Thermobehälter mit Einsätzen

L	Ref.	€	
1,2	61134	33,02	-

INOX 18/10



Termo para alimentos sólidos y líquidos
Thermo for solid food and liquids
Thermo pour aliments solides et liquides
Thermo für feste und flüssige Speisen

L	Ref.	€	
0,5	61155	27,12	-
1	61156	30,65	-

INOX 18/10



Termo líquidos Serie Diana

Thermo Diana for liquids
Thermo Diana pour liquides
Thermoflasche Diana

H (cm)	L	Ref.	€	
19	0,35	61144	11,83	-
24	0,5	61146	13,24	-

INOX 18/10



Serie Diana



Tapón dosificador
Measuring Cup

Termo líquidos Serie Talia

Thermo Talia for liquids
Thermo Talia pour liquides
Thermoflasche Talia

H (cm)	L	Ref.	€	
19	0,35	61182	11,89	-
24	0,5	61184	12,54	-
28	0,75	61186	17,66	-
30	1	61188	20,08	-

INOX 18/10



Serie Talia



Tapón dosificador
Measuring Cup



LunchBag Urban

Ref.	€	
61143	30,01	-

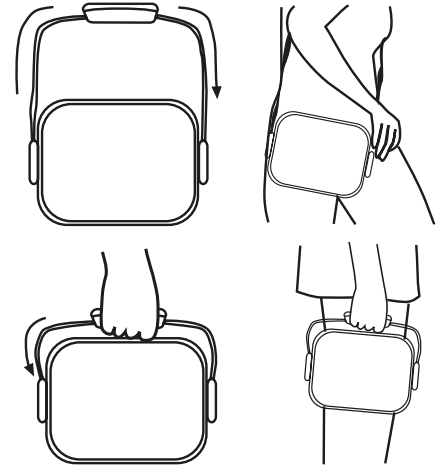

Bolsa compacta protectora de fácil limpieza.
 Easy-to-clean protective compact bag.
 Sac compact de protection facilement lavable.
 Kompakte Schutztasche, problemlos zu reinigen.



Incluyen instrucciones
 Includes instruction

306

Incluyen 2 modernas servilletas
 Includes 2 fashionable napkins
 Four avec deux serviettes modernes
 Mi zwei Servietten mittaktuellem Design



Tupper LunchBag

Ref.	€	
61242	5,36 (*)	-

(*) Disponible - venta individual



Juntas de silicona herméticas · Silicone gaskets hermetic
 Joints en silicone hermétique · Dichtungen aus Silikon Hermetisch



D'Artagnan Set

Ø (cm)	Ref.	€	
20 + 24 y 20	15448	81,31	-

Composición: Sartén antiadherente 20 y 24 cm, Sautex 20, 3 tapas.

Composition: Fry pan with non-stick surface 20 and 24 cm, Sautex 20, 3 lids.

Composition: Poêle à revêtement anti-adhésif 20 et 24 cm, Sautex 20, 3 couvercle verre.

Bestandteile: Spezial-Antihaftpfanne 20 und 24 cm, Sautex 20, 3 Glasdeckel.



INOX 18%



Quantum™ 2
Reinforced non-stick coating



+ 3 tapas · 3 lids



307

Porthos Set

Acero · Steel · Acier · Stahl

Ø (cm)	Ref.	€	
16 - 18 - 20	15446	55,91	-

Composición: cazo 16, 18 y 20 cm.

Composition: saucepan 16, 18 y 20 cm.

Composition: casserole 16, 18 y 20 cm.

Bestandteile: kasserolle 16, 18 y 20 cm.



INOX 18%





Campingline

308

- 1 Olla · stock pot · Marmite · Fleischtopf Ø 20 cm
- 1 Cazo · saucepan · Casserole · Stielkasserolle Ø 16 cm
- 1 Cazo · saucepan · Casserole · Stielkasserolle Ø 14 cm
- 1 Sartén · Fry pan · Poêle · Pfanne Ø 20 cm
- 1 Cestillo · Basket · Panier · Korb Ø 18 cm
- 2 Tapas · Lids · Couvertcles · Deckels Ø 16 y 20 cm

Batería Kamp 7 u
 Kamp cooking set 7 P
 Batterie Kamp 7 P
 Kochgeschirr Kamp 7 P

	Ref.	€	
7 piezas	61117	103,14	



Bolsa isotérmica incluida
 Included isothermal bag
 Sac isotherme inclus
 Isothermie inklusive Tasche



Vaso de camping
Glass for camping
Verre pour le camping
Trinkbecher

Con asa · With handle · Avec poignée · Mit henkel

Ø (cm)	H (cm)	L	Ref.	€	
7,5	9,5	0,33	53083	8,48	-

Sin asa · Without handle · Sans poignée · Ohne Henkel

Ø (cm)	H (cm)	L	Ref.	€	
7,5	9,5	0,33	53084	7,21	-



INOX 18/10 

Plato de camping
Dish for camping
Assiette pour camping
Camping Platzteller

Llano · Flat · Plat · Flach

Ø (cm)	H (cm)	-	Ref.	€	
22	2,5	-	58043	4,67	-

Hondo · Deep · Creuse · Tief

Ø (cm)	H (cm)	-	Ref.	€	
22	4,5	-	58045	5,03	-



INOX 18% 

Fiambrera con tapa plástico
Lunchbox with plastic lid
Gamelle avec plastique couvercle
Proviantbüchse Plastikdeckel

Ø (cm)	H (cm)	L	Ref.	€	
20	6,5	1,75	61120	18,31	-
24	7,5	3	61124	21,04	-



INOX 18/10 

Fiambrera abombada
Bulged lunchbox
Gamelle bombée
Gewölbte Frischhaltebox

Ø (cm)	Ref.	€	
14	61114	8,94	-
16	61116	11,20	-

INOX 



PROMOCIONESline

Set especial
Special set

KooperMe



Ø (cm)	Ref.	€	
24+28	18331	69,84	

310

Set 2 ollas a presión G - SOLA

G -SOLA set 2 pressure cooker
Set 2 cocotte à pression G -SOLA
Set 2 schnellkochtopf G -SOLA

Ø (cm)	L	Ref.	€	
22	4 + 6	50272	185,15	-

- Olla - Pressure cooker: 6 L (Ø 22 cm)
- Olla - Pressure cooker: 4 L (Ø 22 cm)
- Tapa olla a presión - Pressure cooker's lid
- Tapa de cristal- Glass lid (Ø 22 cm)
- Cestillo - Basket



INOX 18/10



Set 5 cazos (12,14,16,18 y 20)

5-saucepan set (12,14,16,18 and 20)
Set de 5 casseroles (12,14,16,18 et 20)
Satz Stielkasserollen (12,14,16,18 und 20)

Ref.	€	
60041	70,57	



INOX 18%





Batería completa Ecco Acero. 8 u.
Ecco Acero complete cooking set. 8 u.
Batterie complete Ecco Acero. 8 u.
Kochgeschirr Ecco Acero. 8 u.

	Ref.	€	
8 piezas	65918	332,70	-

Composición: Ollas 16 y 20, Cacerola 16, 20 y 24, Cazo 14 y 16, y Pote 16.

Composition: Stock pot 16 and 20, Casserole 16, 20 and 24, Saucepan 14 and 16 and Pot 16.



INOX 18/10

Composition: Marmite 16 et 20, Faitout 16, 20 et 24, Casserole 14 et 16, et Gobelet 16.

Bestandteile: Fleischtopf 16 und 20, Bratentopf 16,20 und 24, Stielkasserolle 14, 16 und Milchtopf 16.

Batería completa Ecco Acero. 5 u.
Ecco Acero complete cooking set. 5 u.
Batterie complete Ecco Acero. 5 u.
Kochgeschirr Ecco Acero. 5 u.

	Ref.	€	
5 piezas	65066	236,04	-

Composición: Olla 20, Cacerola 20 y 24, Cazo 16 y Tartera 26.

Composition: Stock pot 20, Casserole 20 and 24, Saucepan 16 and Baking pan 26.



INOX 18/10

Composition: Marmite 20, Faitout 20 et 24, Casserole 16 et Sauteuse 26.

Bestandteile: Fleischtopf 20, Bratentopf 20 et 24, Stielkasserolle 16 und Milchtopf 26.

Batería completa Ecco Cristal. 4 u.
Ecco complete cooking set. 4 u.
Batterie complete Ecco. 4 u.
Kochgeschirr Ecco. 4 u.

	Ref.	€	
4 piezas	65923	161,45	-

Composición: Ollas 20, Cacerola 20 y 24, Cazo 14.

Composition: Stock pot 20, Casserole 20 and 24, Saucepan 14.



INOX 18/10

Composition: Marmite 20, Faitout 20 et 24, Casserole 14.

Bestandteile: Fleischtopf 20, Bratentopf 20 und 24, Stielkasserolle 14.



311

Batería Forma 5 u + 3 tapas de cristal
5 u Forma set + 3 glass lids
Batterie Forma 5 u + 3 couvercles en verre
Topfset Forma 5-tlg. + 3 Glasdeckel

	Ref.	€	
5 u + 3 tapas	60990	119,81	-

Composición: Ollas 16 y 20, Cacerola 24, Cazo 12 y 14.

Composition: Stock pot 16 and 20, Casserole 24, Saucepan 12 and 14.

Composition: Marmite 16 et 20, Faitout 24, Casserole 12 et 14.

Bestandteile: Fleischtopf 16 und 20, Bratentopf 24, Milchtopf 12 und 14.



INOX 18%

Batería Forma 5 u + 2 tapas de cristal
5 u Forma set + 2 glass lids
Batterie Forma 5 u + 2 couvercles en verre
Topfset Forma 5-tlg. + 2 Glasdeckel

	Ref.	€	
5 u + 2 tapas	60995	114,52	-

Composición: Ollas 16 y 20, Cacerola 16 y 20, Cazo 14.

Composition: Stock pot 16 and 20, Casserole 16 and 20, Saucepan 14.

Composition: Marmite 16 et 20, Faitout 16 et 20, Casserole 14.

Bestandteile: Fleischtopf 16 und 20, Bratentopf 16 und 20, Milchtopf 14.



INOX 18%



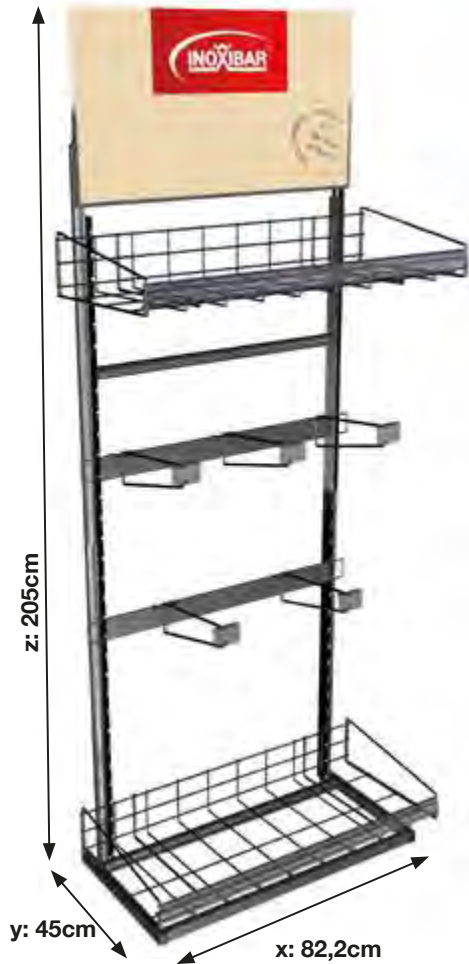

Expositor mediano
Medium Showcase
Présentoir moyen
Schaukasten

x (cm)	y (cm)	z (cm)	Ref.	€	
82,2	45	205	10260	421,20	1

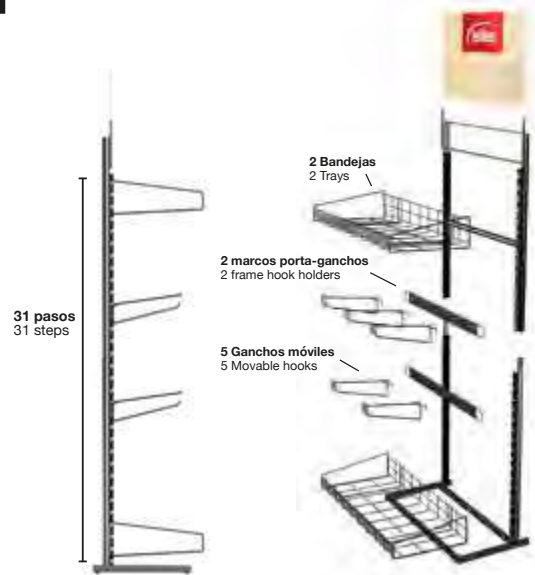

312



Palet box
Palet box
Palet box
Palet box

56 unidades de sartenes: 28 unidades de cada medida
56 units of frypans: 28 units of each measure
56 unités de poêles : 28 unités de chaque mesure
56 Einheiten Pfannen: 28 Einheiten von jedem Maß

x (cm)	y (cm)	z (cm)	Ref.	
80	60	138	10223	BOX SARTEN SKY 18+24CM
80	60	138	10224	BOX SARTEN SKY 20+26CM
80	60	138	10225	BOX SARTEN ABSOLUT BLACK 18+24CM
80	60	138	10226	BOX SARTEN ABSOLUT BLACK 20+28CM
80	60	138	10227	BOX SARTEN FOREST 20+26CM
80	60	138	10228	BOX SARTEN FOREST 24+28CM



Ejemplos orientativos (otras opciones son posibles)
Indicative examples (other options are possible)

Delantal 100% algodón adulto

Apron 100% cotton
 Tablier 100% coton
 Schürze 100% katoen

Ref.	€	
10245	16,95	-
10246	16,95	-
10247	16,95	-

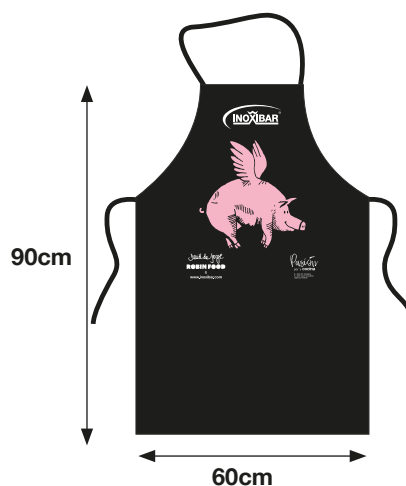

ref.10245
INOXIBAR



ref.10246
Robin Food



ref.10247
Sandías

Delantal 100% algodón infantil

Apron 100% cotton
 Tablier 100% coton
 Schürze 100% katoen

Ref.	€	
10248	15,25	-
10249	15,25	-

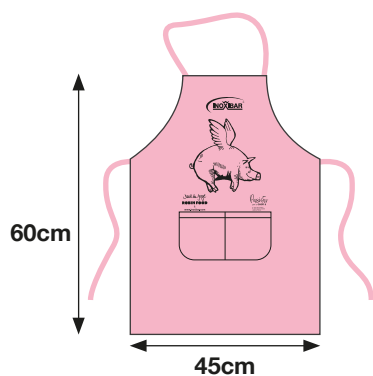

ref.10248
INOXIBAR



ref.10249
Robin Food



Set trapos de cocina

Set kitchen rags
Set torchons
Set Lappens

Ref.	€	
10218	10,95	-



Set de 2 manoplas textiles

2 Textile oven gloves set
Set 2 gants pour le four
2 Textilhandschuhe satz

Ref.	€	
10211	10,57	-



314



Las bolsas de plástico de un solo uso tardan en degradarse AÑOS.

¡REUTILIZA!

Single-use plastic bags take YEARS to degrade.

RE-USE!

Bolsa no tejido termosellada con fuelle

Heat-sealed non-woven bag with gusset
Sac en non-tissé thermosoudé avec gousset
Set Lappens

Ref.	€	
102144	5,84	-



reutilizable
reusable



INOXIBAR
y el medioambiente
and the environment

#inoxibarporelmedioambiente

Recetas

Recipes
Recettes
Rezepte

Cocinando sueños

Cooking dreams
Cuisson des rêves
Kochträume



Recipes by *David de Jorge*

ROBIN FOOD



Ragú de ñoquis
Gnocchi ragout
Ragoût de gnocchis
Gnocchi-Ragout

Ingredientes

Ingredients

Ingrédients

Zutaten

316

- 250 g de queso ricotta o similar
- 25 g de harina
- 1 huevo
- 1 cucharada sopera de aceite de oliva, sal y pimienta

Para la verdura:

- 3 alcachofas crudas + 2 cogollos tiernos de lechuga
- 12 brotes de zanahoria + 2 chalotas picadas +
- 100 g de guisantes cocidos + 100 g de habas cocidas repeladas 200 g de setas silvestres limpias
- 1 ramillete de albahaca + 2 hojas de salvia fresca
- 2 dl. de caldo de pollo
- 3 lonchas finas de jamón ibérico en tiras anchas de 2 cm. 50 g de queso Idiazábal rallado
- 4 cucharadas de mantequilla
- Aceite de oliva, sal y pimienta

- 250gr of ricotta cheese or similar
- 25gr of flour
- 1 egg
- 1 tablespoon of olive oil, salt and Pepper

For the vegetable:

- 3 raw artichokes + 2 tender hearts of lettuce
- 12 carrot sprouts + 2 chopped shallots + -100gr of cooked peas + 100gr of broad beans boiled, peeled
- 200gr of clean wild mushrooms
- 1 sprig of basil + 2 fresh sage leaves
- 2dl. chicken broth
- 3 thin slices of Iberian ham in 2 cm wide strips. 50gr grated Idiazábal cheese
- 4 tablespoons of butter
- Olive oil, salt and pepper.



<https://www.daviddedejorge.com/es/inicio>



Preparación

Preparation

Préparation

Zubereitung

- Poner una olla con abundante agua hirviendo.
- Poner un baño de agua helada con hielos.
- En un bol mezclar ricotta + harina + huevo + aceite de oliva + salpimenta, mezclar con unas varillas.
- Reservar la mezcla bien cubierta en un bol.
- Verdura, dividir en troncos estrechos el cogollo de lechuga + trocear las alcachofas en cuartos.
- En un sauté amplio, ancho y bajo con aceite + mantequilla, sofreír las alcachofas unos minutos.
- Añadir jamón + cogollos de lechuga + zanahorias + chalotas + salvia, sofreír + mojar con caldo + salpimenta, guisar 8 min.
- Mientras, hacer los ñoquis, en la olla con agua apenas hirviendo, añadir pequeñas bolas-que-

- lles hechas con dos cucharillas de café.
- Cuando las bolas suben a la superficie están hechas, escurrirlas y sumergirlas en el baño de agua helada.
- Ecurrimos los ñoquis sobre una bandeja untada de aceite de oliva.
- Añadir los ñoquis al estofado de verduras y darle unas vueltas para que se empapen.
- Saltear las setas + aceite + salpimenta.
- Terminar el estofado de verduras añadiendo queso parmesano + guisantes + habas + setas.
- Romper la albahaca cruda por encima + hilo de aceite de oliva + pimentar.
- Rectificar la sazón.
- ¡Listo!

- Put a pot with plenty of boiling water.
- Put an ice water bath with ice.
- In a bowl, mix ricotta + flour + egg + olive oil + salt and pepper, mix with a whisk.
- Reserve the mixture well covered in a bowl.
- Vegetables, divide the lettuce heart into narrow trunks + cut the artichokes into quarters. -In a wide, wide and low sauté with oil + butter, fry the artichokes for a few minutes.
- Add ham + lettuce hearts + carrots + shallots + sage, fry + moisten with broth + salt and pepper, cook for 8 min.
- Meanwhile, make the gnocchi, in the pot with barely boiling water, add small balls-quenelles made with

- two teaspoons of coffee.
- When the balls rise to the surface they are done, drain them and immerse them in the ice water bath.
- Drain the gnocchi on a tray greased with olive oil.
- Add the gnocchi to the vegetable stew and stir it a few times to soak it up.
- Sauté the mushrooms + oil + salt and pepper.
- Finish the vegetable stew by adding Parmesan cheese + peas + broad beans + mushrooms.
- Break the raw basil on top + olive oil thread + pepper.
- Rectify the seasoning.
- Ready!



Sartén Profesional antiadherente con asa reforzada
Professional Non-stick surface frying pan with extra handle
Poêle Professionnelle antiadhésive avec poignée robuste
Pfanne Professional Antihaftr robuster griff

pág. 25
page 25



Rallador mango ABS
Grater ABS handle
Râpe à manche ABS
Stabreibe ABS-Griff

pág. 183
page 183





Vieiras a la gallega

Galician-style scallops
Saint-Jacques à la galicienne
Jakobsmuscheln auf galizische Art

Ingredientes

Ingredients

318

Ingrédients

Zutaten

- 12 vieiras limpias, con su concha
- 350gr de jamón serrano muy picado
- 2 cebolletas picadas
- 2 dientes de ajo picados
- 1 pizca de chile fresco
- 1 chorrete de vino blanco tipo albariño
- 1 tomate maduro
- 12 gambas arroceras peladas
- Perejil fresco picado
- Pan rallado fresco
- Aceite de oliva
- 1 pizca de mantequilla
- Sal y pimienta

- 12 clean scallops, with their shell
- 350gr of very chopped Serrano ham
- 2 chopped chives
- 2 minced garlic cloves
- 1 pinch of fresh chili
- 1 splash of white wine type albariño
- 1 ripe tomato
- 12 peeled rice prawns
- Chopped fresh parsley
- Fresh breadcrumbs
- Olive oil
- 1 pinch of butter
- Salt and pepper



<https://www.daviddedejorge.com/es/inicio>



Preparación

Preparation

Préparation

Zubereitung

- Separar los corales de las vieiras.
- Reservar las conchas cóncavas.
- En una olla, sofreír el jamón + aceite.
- Añadir la cebolleta + ajo + chile y dar unas vueltas.
- Añadir el vino + rallar tomate y guisar unos 15 minutos.
- Picar las gambas + corales de las vieiras.
- Mezclar el perejil + pan rallado en un bol.
- Encender el grill del horno.
- Añadir al sofrito las gambas + corales, dar unas

- vueltas y rectificar la sazón.
- Colocar una base del sofrito en las conchas.
- Sobre cada base de sofrito, apoyar la vieira cortada en 2 lonchas gruesas, a lo ancho.
- Cubrir con el resto de sofrito.
- Espolvorear la superficie con la mezcla de perejil y pan.
- Colocar unos pellizcos de mantequilla y tostar al grill.
- ¡Listo!

- Separate the corals from the scallops.
- Reserve the concave shells.
- In a pot, fry the ham + oil.
- Add the spring onion + garlic + chili and give a few laps.
- Add the wine + grate tomato and cook about 15 minutes.
- Chop the prawns + scallop corals.
- Mix the parsley + breadcrumbs in a bowl.
- Turn on the oven grill.

- Add the prawns + corals to the sauce, stir a few times and correct the seasoning.
- Place a base of the sauce in the shells.
- On each base of the sauce, support the scallop cut into 2 thick slices, widthwise.
- Cover with the rest of the sauce.
- Sprinkle the surface with the mixture of parsley and bread.
- Place a few pinches of butter and toast on the grill.
- Ready!



Cacerola Coal
Coal casserole
Faitout Coal
Bratentopf Coal

pág. 71
page 71



Picaperejil Elite
Elite fine herbs mincer
Hachoir à manivelle pour fines herbes Elite
Kräutermühle, fein rostfrei Elite

pág. 184
page 184



Costillas de cerdo con salsa de perejil

Pork ribs with parsley sauce

Côtes de porc à la sauce persillée

Schweinerippchen mit Petersiliensoße

Ingredientes

Ingredients

Ingrédients

Zutaten

320

- 12 costillas de cerdo blanco (1kg aprox.)
- 3L de agua
- 1 cebolla entera
- 1 zanahoria entera
- 1 puerro pequeño
- 1 rama de apio
- 1 hueso de jamón
- 1 pizca de sal
- 6 dientes de ajo con piel
- 1 cucharada soperas de aceite de oliva
- 30gr de salsa de soja

Para la salsa de perejil y limón:

- 9 cucharadas soperas de aceite de oliva virgen extra
- 6 dientes de ajo asado
- 60gr de zumo de limón
- 3 cucharadas soperas de vinagre de sidra
- 6gr de perejil picado
- Sal y pimienta

- 12 white pork ribs (1kg approx.)
- 3L of water
- 1 whole onion
- 1 whole carrot
- 1 small leek
- 1 stalk of celery
- 1 ham bone
- 1 pinch of salt
- 6 garlic cloves with skin
- 1 tablespoon of olive oil
- 30g of soy sauce

For the parsley and lemon sauce:

- 9 tablespoons of extra virgin olive oil
- 6 roasted garlic cloves
- 60g of lemon juice
- 3 tablespoons of cider vinegar
- 6g of chopped parsley
- Salt and pepper



<https://www.daviddedejorge.com/es/inicio>



Preparación

Preparation

Préparation

Zubereitung

-Colocar en una olla la cebolla, la zanahoria, el puerro la rama de apio y el hueso de jamón, las costillas, agregar los 3L de agua, una pizca de sal y cocer durante 50 minutos a partir de que rompa el hervor.

-Espumar las impurezas, a medida de que vayan subiendo a la superficie.

-Pasado el tiempo retirar las costillas del caldo, trocearlas y colocarlas en una bandeja de horno.

-Precalentar el horno a 210°C (modo grill)

-Mezclar la salsa de soja con la cucharada sope-
ra de aceite de oliva y pincelar las costillas con la ayuda de una brocha.

-Añadir los dientes de ajo y hornear las costillas hasta que tuesten y cojan buen color.

-Los dientes de ajo los utilizaremos para la salsa

de perejil.

-Retirarlas del horno, aliñarlas con la salsa de perejil y servir.

Para la salsa de perejil y limón:

-Picar finamente el perejil y cubrirlo con el aceite de oliva.

-Añadir los dientes de ajo asados, el zumo de limón y el vinagre.

-Triturar todo junto con un túrmix.

-¡Listo!

Observaciones: Podemos aprovechar el caldo que nos queda para hacer alguna sopa u otra preparación.

-Place the onion, the carrot, the leek, the celery stalk and the ham bone, the ribs in a pot, add the 3L of water, a pinch of salt and cook for 50 minutes after it starts to boil.

-Foam the impurities, as they rise to the surface.

-When the time has elapsed, remove the ribs from the broth, chop them up and place them on a baking tray.

-Preheat the oven to 210°C (grill mode)

-Mix the soy sauce with the tablespoon of olive oil and brush the ribs with the help of a brush.

-Add the garlic cloves and bake the ribs until they are toasted and take on a good color.

-We will use the garlic cloves for the parsley sauce.

-Remove them from the oven, dress them with the parsley sauce and serve.

For the parsley and lemon sauce:

-Chop the parsley finely and cover it with the olive oil.

-Add the roasted garlic cloves, lemon juice and vinegar.

-Mash everything together with a blender.

-Ready!

Observations: We can take advantage of the broth that we have left to make some soup or other preparation.



Rustidera rectangular asa monobloc

Rectangular roasting tin monobloc handle
Plat à gratin rectangulaire poignée monobloc
Bratform rechteckig Grifftrand

pág. 188
page 188



Pincel de silicona

Silicone brush
Pinceau en silicone
Silikonbürste

pág. 217
page 217



Flan de chocolate

Chocolate flan
Flan au chocolat
Schokoladen-Flan

Ingredientes

Ingredients

Ingrédients

Zutaten

-125gr de chocolate negro
-4dl de leche
-2dl de nata
-170gr de azúcar
-1 vainilla
-4 huevos

Para el caramelo de café:

-175gr de azúcar
-1dl de café expresso

-125gr of dark chocolate
-4dl of milk
-2dl of cream
-170gr of sugar
-1 vanilla
-4 eggs

For the coffee caramel:

-175gr of sugar
-1dl of espresso coffee



<https://www.daviddedejorge.com/es/inicio>



Preparación

Preparation

Préparation

Zubereitung

- Precalentar el horno a 150°C.
- Fundir el chocolate al baño maría y reservar.
- Hervir en un cazo la leche, la nata, la mitad del azúcar y la vaina de vainilla abierta y raspada.
- Una vez que hierva, dejar entibiar la mezcla hasta los 50/60°C aproximadamente.
- Retirar la vaina de vainilla y agregar el chocolate fundido a la mezcla anterior.
- Homogenizar el conjunto con ayuda de una varilla.
- Por otro lado batir en un bol los huevos con el resto del azúcar en un bol.
- Incorporar la mezcla de huevos a la preparación anterior y volver a homogenizar con ayuda de una varilla, hasta que la mezcla esté completamente integrada.

- Rellenar la base de las flaneras con un poco de caramelo y dejar que enfríe para que no se mezcle después con la mezcla del flan.
- Una vez que el caramelo esté frío rellenar las flaneras con el mezcla de chocolate dejando un margen de un dedo.
- Introducir en el horno y cocerlos a 150°C durante 25 a 30 minutos.

Para el caramelo de café:

- Colocar el azúcar y el café en una cazuela llevar al fuego y realizar un caramelo, no debe quedar muy líquido unos 7 minutos aproximadamente.
- Volcar el caramelo en las flaneras y dejar enfriar antes de colocar la mezcla del flan.
- ¡Listo!

- Preheat the oven to 150°C.
- Melt the chocolate in a bain-marie and set aside.
- Boil the milk, cream, half of the sugar and the open and scraped vanilla pod in a saucepan.
- Once it boils, let the mixture warm up to approximately 50/60°C.
- Remove the vanilla pod and add the melted chocolate to the previous mixture.
- Homogenize the whole with the help of a rod.
- On the other hand, beat the eggs in a bowl with the rest of the sugar in a bowl.
- Incorporate the egg mixture into the previous preparation and homogenize again with the help of a whisk, until the mixture is completely integrated.

- Fill the base of the flaneras with a little caramel and let it cool so that it does not mix later with the flan mixture.
- Once the caramel is cold, fill the flaneras with the chocolate mixture, leaving a margin of one finger.
- Introduce them in the oven and cook them at 150°C for 25 to 30 minutes.

For the coffee caramel:

- Place the sugar and coffee in a casserole, bring to the heat and make a caramel, it should not be very liquid for approximately 7 minutes.
- Pour the caramel into the flaneras and let cool before adding the flan mixture.
- Ready!



Cazo Forêt
Forêt saucepan
Casserole Forêt
Stielkasserolle Forêt

pág. 77
page 77



Flanero pulido exterior
Custard mould
Moule à flan
Puddingform aussen poliert innen satiniert

pág. 201
page 201

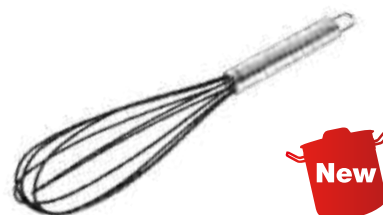

Batidor silicona mango inox
Silicon whisk inox handle
Fouet silicone manche acier
Silikonrührbesen

pág. 218
page 218

Recipes by *David de Jorge*

ROBIN FOOD



Anexo

Annex

Annexe

Attachment

Listas de referencia, repuestos...

List of references, spare parts...

Liste des références, pièces détachées...

Aufstellung der Artikelnummern, Ersatzteile...

A	Escurridor enrollable	221	Prensador Elite	233	
Aceitera antigoteo	179	Espátulas	196, 197, 204, 208, 210, 212, 214, 215, 216, 217, 230, 236, 237	Prensapatatas	204, 212
Adaptador inducción-vitro	103	Especieros	250, 251	R	
Aireador de vino	280	Espumaderas	204, 206, 207, 208, 212	Rabaneras	252
Anillo antigoteo	279	Expositor	312	Racionador helado	201, 231
Asas silicona	202	F		Ralladores	120, 181, 182, 183, 235
Azucarero	270	Fiambreras	309	Rejilla para la cubitera	274
B		Flaneros	201	Rejilla pizza	235
Balanza	186	Freidoras	54, 99, 100, 101	Reposacucharas	223
Bandeja "Llauna"	188, 189, 248, 249	Fuentes	188, 190, 191, 200, 256, 257	Repuestos	341, 342
Bandeja portafactura	253	G		Rizador de limón	230
Base de madera	248	Grasera	179	Ruleta cortapizza	234
Batidor	201, 218, 219	Grill	66, 67, 148, 149	Rustideras	186, 190, 249, 287
Batería Ecco	311	J		S	
Batería Forma	311	Jarras	178, 258	Sacacorchos	278
Batería Kamp	59, 308	Juntas (recambios)	41, 249, 315	Salero	250
Besuguera	194	L		Salvamangos	202
Bolsa reutilizable	314	Lecheras	252, 253	Salvamanteles	260, 261
Bolset	259	Legumbreras	259	Sartenes	24, 25, 54, 55, 64, 65, 71, 77, 81, 94, 95, 96, 99, 114, 115, 119, 122, 124, 129, 133, 136, 137, 140, 141, 146, 147, 152, 153, 157, 160, 161, 163, 165, 167
Bomba de vacío	279	Llauna	188, 189, 248, 249	Sautex	24, 25, 54, 96, 97
Boquillas	280	Lunchbag	306	Servilletero	262, 263, 282, 283
Botella termo	292	M		Set protector sartenes	152
C		Mango multiuso Security	97	Soperas	259
Cacerolas	18, 19, 31, 36, 50, 52, 64, 65, 71, 76, 80, 88, 89, 90, 91	Manoplas	314	Soporte de pie	222
Cacillo dosificador de café	178	Moldes	200	Soporte mesa para cubo champagne	276
Cafetera	266, 267, 270	Molinillos	221	Soporte pared	222
Caldero	176	O		Soporte sartenes	220
Campana	246, 247, 286	Ollas	18, 21, 31, 36, 40, 50, 52, 64, 65, 76, 88, 89, 90, 91, 102	Soporte tablas	220
Camping	308, 309	Olla Baño María	21	Suplemento olla colador	20, 51
Cascanueces	244	Olla a presión G-Sola	40	T	
Cazos	22, 23, 37, 54, 64, 65, 77, 92, 93, 97, 100, 101	P		Tapas	20, 24, 31, 37, 41, 55, 95, 97, 104, 105, 106
Cazos (utensilios)	204, 206, 207, 208, 210, 212, 216, 217	Paelleras	18, 19, 67, 71, 76, 114, 115, 123, 125, 133, 142, 149, 157, 161	Tapones	279
Cedazo	174, 175	Pala pizza	235	Tarteras	37, 51, 53, 88, 89, 90, 91
Cesta de malla cocedor	22	Paletas	196, 231, 234	Tenedores	204, 209, 213
Cesta perforada - colador	100, 101	Parrilla	194, 195	Termos	292, 295, 304, 305
Cestillos	99, 101	Parrilla de verduras	195	Termos Joy	294
Champanero	272	Parrilla sobremesa	195	Thermocan	298, 299, 300, 301, 302
Cocedores	21, 102	Pasapurés	172, 173	Teteras	268, 270
Coladores	224, 225, 228, 229	Peana porta-cubos	275	Trapo de cocina	314
Colador gusanillo	233, 277	Pelador	244	V	
Colador infusiones	269	Pelapatatas	244	Vaciador de frutas	230
Conjunto cacerola y colador	51, 53	Picaperejil	184, 233	Vaso de camping	309
Conjunto vapor olla	51, 53	Picadores	185	Vinagrera	264
Crepera	64, 65, 146, 147	Pincel	216, 217	Volteador tortilla	103
Cubitera de hielos	272, 273, 274	Pinzas	198, 199, 202, 238, 239, 240, 241, 242, 243, 277	W	
Cubitos de acero	276	Pizarras	288	Wok	24, 25, 71, 77, 114, 115, 157
Cucharas (utensilios)	205, 209, 211, 213, 214, 215	Plancha	66, 81, 148, 165		
Cucharas esferificaciones	238	Platillos	252, 253		
Cuchara espagueti	205, 210	Platillo para el pan	252		
Cucharas de medida	178	Plato de camping	309		
Cúpula	246, 247, 286, 287	Plato para servir	252		
D		Portarrollos multifuncion	244		
Delantales	313	Posabotellas	252		
Descapsulador	231, 279	Posavasos	252		
E		Potes	54, 92, 93		
Ensaladera	259	Prensa ajos	184, 232		
Escanciador	280				
Escurridores	53, 163				
Escurridor de cubiertos	233				

A		G		R	
Anti-drip oilers	179	Garlic press	232	Roasting pans	188, 189, 190, 191
Anti-drip pourers	280	Glass stand	252	Round dish	256, 257, 284, 285
Anti-drip ring	279	Graters	181, 182, 183		
Appetizer dish	252	Grill	66, 67, 77, 173	S	
Apron	313			Salad bowl	259
Asparagus cooker	21	H		Saucepans	24, 25, 54, 55, 64, 65, 71, 77, 81, 94, 95, 96, 99, 119, 122, 124, 129, 133, 136, 137, 140, 141, 146, 147, 152, 153, 157, 160, 161, 163, 165, 167
		Handle saver	202	Sautex	24, 25, 54, 96, 97
B				Scales	186
Baking pans	37, 51, 53, 88	I		Serving dish	235
Baskets	101	Ice bucket	272, 273, 274	Showcase	312
Bill tray	253	Ice bucket grid	273, 274	Sieve	174, 175
Bolset	259	Ice cream scoop	231	Skimmers	204, 206, 207, 208, 212
Board	288			Soup tureens	259
Board rack	220	J		Spaghetti spoon	205, 210
Bottle coaster	252	Joy Thermos	294	Spare parts	341, 342
Bouquet drip proof pourer	279	Jugs	258	Spatulas	196, 197, 204, 208, 210, 212, 214, 215, 216, 217, 230, 236, 237
Bouquet stopper	279			Spice jars	250
Bread and butter plate	252	K		Spoon rest	223
Brush	216	Kitchen rag	314	Spoons (utensils)	204, 206, 207, 208, 210, 212, 216, 217
				Stainless steel table grill	195
C		L		Stand	222
Camp site	308	Ladle	204, 206, 208, 210, 212, 216, 217	Steam cooker set	51, 53
Camping	308, 309	Lemon zester	230	Steam stock pot set	51, 53
Camping plate	309	Lids	20, 24, 31, 37, 41, 55, 95, 97, 104, 105, 106	Steel baking	248, 249
Caps	287	Lunch boxes	306	Steel cubes	276
Casserole dishes	18, 19, 31, 36, 50, 52, 64, 65, 71, 76, 80, 88, 89, 90, 91	Lunchbag	306	Stock pots	18, 21, 31, 36, 40, 50, 52, 64, 65, 76, 88, 89, 90, 91, 102
Chip pan	54, 100, 101			Stock pot double boiler	21
Champagne cooler	272	M		Strainers	224, 225, 228, 229, 269, 277
Champagne bucket	272	Measuring sets	178	Sugar bowl	270
Coaster set	252	Measuring spoons	178	Spherification spoon	238
Cocktail strainer	277	Milkpots	270, 271		
Coffee scoop	178	Mills	251	T	
Coffeepot	266, 267	Mixers	172, 173	Table grill	195
Colanders	20, 41, 51, 53, 100, 101, 177	Mixing bowl	176	Tabletop stand for champagne bucket	275
Colander pot	51	Moulds	200	Teapots	268, 270
Colander-strainer	100, 101	Multipurpose roll holder	244	Thermos	304, 305, 292,
Cooking set Ecco	311	Multipurpose security handle	97	Thermocan	298, 299, 300, 301, 302
Cooking set Forma	311			Tongs	239, 240, 241, 242, 243
Cooking set Kamp	58, 308	N		Trays	188, 189, 248, 249, 253
Corkscrews	278	Napkin rack	262, 263, 282, 283	Trivets	260
Crepe maker	64, 65	Nutcracker	244		
Custard mould	201			V	
Cutlery drainer	221	O		Vacuum pump	261
		Oil bottle	179	Vegetable bowl	237
D		Omelette turn-over lid	106	Vinegar and oil set stand	244
Deep casserole	18	Onion chopper	185		
Deep fry pan	66, 81, 148, 165	Oven gloves	202	W	
Duo Set	96			Wall support	222
		P		Water jugs	258
E		Paella pans	24, 25, 67, 71, 76, 112, 90, 91, 112, 113, 117, 119, 123, 129, 135, 143, 147	Whisk	201, 218, 219
Ecco cookware set	311	Pancake	64, 65, 146, 147	Wine aerator	280
		Parsley and herb cutter	184	Wok	24, 25, 71, 77, 114, 115, 157
F		Peeler	244	Wood base	245
Foil cutter	279	Pizza cutter	234		
Forks	188, 195, 199	Pizza grid	235		
Fruit baller	230	Porthos Set	97, 307		
Fry pans	24, 25, 54, 55, 64, 65, 71, 77, 81, 94, 95, 96, 99, 119, 122, 124, 129, 133, 136, 137, 140, 141, 146, 147, 152, 153, 157, 160, 161, 163	Pot and steamer set	51, 53		
Fry pans support	220	Potato chip cutter	232		
		Potato peeler	244		
		Potato press	185		
		Pots	54, 92		
		Pizza slice	235		

A		Grill	66,67, 148, 149	R	
Aérateurs de vin	280	Grill à légumes	195	Râpes	180, 181, 182, 183
Adaptateur inductin-vitro	103	Grille de table	195	Ravier	252
Assiette de camping	309			Rechanges	341, 342
Assiette de présentation	253	H		Récipients pour huile	179
		Hachoir	185	Récipients en plastique	306
B		Hachoir à persil	184, 233	Repose-cuillères	223
Balance	186, 187	Huile et vinaigrier support	264	Rond de serviette	263
Batterie Ecco	311			Roulette à pizza	234
Bassine	176	J			
Batterie Forma	311	Joints (rechanges)	41, 267, 341, 342	S	
Batterie Kamp	59, 308			Saladier	259
Becs	280	L		Salière	250
Bec Verseur bouquet anti-gouttes	280	Légumier	259	Saucière avec séparateur de graisse	179
Bolset	259	Louche	204, 206, 207, 208, 210, 212, 216, 217	Sauteuse	23, 37, 51, 53, 88, 89, 90, 91, 191, 248, 249
Bouchons	278	Lunchbag	306	Sautex	24, 25, 54, 96, 97
				Seau à champagne semi-sphérique	272
C		M		Seau à glace	272, 273, 274
Café mesurée	178	Manches en silicone	202	Socle en bois	248
Cafetière	266, 267, 270	Marmite	18, 31, 36, 50, 52, 64, 65, 76, 88, 89, 90, 91, 102	Soupières	259
Camping	307, 308, 309	Marmite bain-marie	21	Sous-plat	235, 253
Carafe à jus de fruits	178, 258	Moules	200	Sous-plat de bouteilles	252
Carafe d'eau	178	Moules à flan	201	Sous-verres	252
Casse-noisettes	244	Moulins	251	Spatules	196, 197, 204, 208, 210, 212, 217, 230, 236, 237
Casserolles	22, 23, 37, 54, 64, 65, 77, 92, 93, 97, 100, 101	Moulin à fromage	181, 235	Sucrier	270
Casserole à friture	54, 100, 101			Supplément cocotte passoire	20, 51
Cloche	246, 247, 286, 287	P		Support de pied	222
Cocotte à pression	40, 310	Panier ajouré - passoire	41, 101	Supplément marmite	20, 51
Collier anti-gouttes bouquet	279	Panier de cuisson	22	Supplément panier cuit-vapeur	20, 22
Coupe capsule	279	Paniers	22, 101	Support de table pour le seau à champagne	276
Coupe-frites	232	Panier pour porte couvert	221	Support pour planches	220
Couvercle retourne-omelette	103	Passoire à cocktail	233, 277	Support pour poêles	221
Couvercles	104, 105	Passoires	224, 225, 228, 229		
Crêpière	62, 64, 65, 109	Passoire-égouttoir	100, 101	T	
Cuillère à spaghetti	205	Pelle pizza	235	Tableau mural	288
Cuillère pour sphérifications	238	Petite assiette pour le pain	252	Tablier	313
Cuillère parisienne	230	Pièces détachés	341, 342	Tamis	174, 175
Cuillères (ustensiles)	205, 209, 211, 213, 214, 215	Pinceau	216, 217	Théières	268, 269, 270
Cuillères à glace	201	Pinces	198, 199, 202, 238, 239, 240, 241, 242, 243, 277	Thermocan	295, 298, 299, 300, 301, 302
Cuiseurs	21	Plaque à grill	66, 81, 111, 148, 165	Thermos	292, 295, 304, 305
		Plat à gratin	188, 189, 190, 191, 248, 249	Thermos Joy	294
D		Plat à paella	18, 19, 67, 71, 76, 114, 115, 123, 125, 133, 142, 149, 157, 161	Tire-bouchon	278
D'Artagnan set	307	Plats	192, 193, 254, 255	Torchon	314
Décapsuleur	243, 277, 278	Plat pour monnaie	252, 253		
Dessous-de-bouteille	252	Plat rond	256, 257, 284, 285	V	
		Poêle pour friture	54, 99, 100, 101	Verre de camping	309
E		Poêles	24, 25, 64, 65, 71, 77, 81, 94, 95, 96, 99, 114, 115, 119, 122, 124, 129, 133, 136, 137, 140, 141, 146, 147, 152, 153, 157, 160, 161, 163, 165, 167	Verseur à cidre	280
Écumoirs	204, 206, 207, 208, 212				
Égouttoir à couverts	223	Pompe à vide	279	W	
Égouttoirs	221, 223	Porte addition	253	Wok	24, 25, 71, 77, 114, 115, 157
Ensemble marmite vapeur	51, 53	Porte-rouleaux multifonctions	244		
Ensemble faitout et passoire	51, 53	Porte seau à champagne	275	Z	
Éplucheur	224	Porte-serviettes	262, 263, 282, 283	Zesteur citron	230
		Porthos set	97, 307		
F		Pots à eau	258		
Faitout	18, 19, 31, 36, 50, 52, 64, 65, 71, 76, 80, 88, 89, 90, 91	Pots à épices	250		
Fouet	201, 218, 219	Pots à lait	271		
Fourchettes	204, 209, 213	Presse-ail	184, 232		
		Presse-pomme	185		
G		Presse-purée	172, 173		
Gants pour le four	67, 149, 202, 314	Présentoir	312		
Gamelles	309				
Glaçons	276				
Gobelet	55, 92, 93				

Referencia / Reference / Référence / Arkitel

Ref.	EAN	Pág.	Ref.	EAN	Pág.	Ref.	EAN	Pág.	Ref.	EAN	Pág.
6	8422370000060	222	13318	8422370133188	231, 234	13420	8422370134208	244	15015	8422370150154	178
9	8422370000091	264				13440	8422370134406	234	15102	8422370151021	97
7000	8422370070001	247, 286	13320	8422370133201	230	13450	8422370134505	196, 234, 236	15103	8422370151038	97
7010	8422370070100	247, 286	13322	8422370133225	230				15104	8422370151045	97
10211	8422370102115	202, 314	13324	8422370133249	231, 278	13452	8422370134529	196, 236	15444	8422370154442	97
			13330	8422370133300	232				15446	8422370154466	97, 307
10218	8422370102184	314	13331	8422370133317	232	13460	8422370134604	197, 237			
									15447	8422370154473	96
10245	8422370102450	313	13332	8422370133324	181, 235	13461	8422370134611	197, 237	15448	8422370154480	96, 307
10246	8422370102467	313	13334	8422370133348	285	13462	8422370134628	197, 237			
10247	8422370102474	313	13336	8422370133362	184, 344				18043	8422370180434	189, 249
10248	8422370102481	313				13463	8422370134635	196, 236			
			13340	8422370133409	185				18045	8422370180458	189, 245
10249	8422370102498	313				13465	8422370134659	197, 237			
10260	8422370102603	312	13342	8422370133423	233				18047	8422370180472	189, 249
			13344	8422370133447	233	13466	8422370134666	197, 237			
13007	8422370130071	223							18049	8422370180496	189, 249
			13345	8422370133454	244						
13019	8422370130194	222				13467	8422370134673	197, 237			
			13366	8422370133669	201, 231				18051	8422370180519	260
13151	8422370131511	204				13470	8422370134703	197, 237			
			13368	8422370133683	201, 231				18053	8422370180533	261
13152	8422370131528	204							18055	8422370180557	261
						13472	8422370134727	197, 237			
13161	8422370131610	204	13370	8422370133706	201, 231				18056	8422370180564	248
13171	8422370131719	204				13474	8422370134741	197, 237			
			13372	8422370133720	201, 231				18057	8422370180571	248
13181	8422370131818	205									
						13476	8422370134765	197, 237	18060	8422370180601	257, 285
13191	8422370131917	204	13374	8422370133744	201, 231						
									18062	8422370180625	257, 285
13192	8422370131924	205				13480	8422370134802	197, 237			
			13402	8422370134024	241				18063	8422370180632	235, 253
13201	8422370132013	230	13404	8422370134048	198, 238	13482	8422370134826	197, 237			
									18064	8422370180649	252
13203	8422370132037	230									
			13405	8422370134055	277	13484	8422370134840	197, 237			
13205	8422370132051	230							18068	8422370180687	193, 255
			13406	8422370134062	241						
13306	8422370133065	184, 232				13486	8422370134864	197, 237			
			13410	8422370134109	241				18070	8422370180700	193, 255
13312	8422370133126	201, 231	13412	8422370134123	241	13488	8422370134888	197, 237			
									18072	8422370180724	193, 255
			13413	8422370134130	269						
13316	8422370133164	231				14005	8422370140056	178			
			13417	8422370134178	238				18074	8422370180748	193, 255
						14007	8422370140070	22, 200			
			13418	8422370134185	244						

Referencia / Reference / Référence / Arkitel

Ref.	EAN	Pág.	Ref.	EAN	Pág.	Ref.	EAN	Pág.	Ref.	EAN	Pág.
18075	8422370180755	191	18124	8422370181240	64, 146	18189	8422370181899	257, 285	18421	8422370184210	160
18076	8422370180762	193, 255	18125	8422370181257	65, 147	18190	8422370181905	257, 285	18422	8422370184227	81, 165
18077	8422370180779	191	18126	8422370181264	64, 146	18199	8422370181998	189	18424	8422370184241	81, 165
18078	8422370180786	193, 255	18127	8422370181271	65, 147	18224	8422370182247	66, 148	18425	8422370184258	160
18079	8422370180793	191	18128	8422370181288	64, 146	18226	8422370182261	64, 146	18426	8422370184265	81, 165
18080	8422370180809	193, 255	18129	8422370181295	65, 147	18227	8422370182278	65, 147	18428	8422370184289	81, 165
18081	8422370180816	191	18130	8422370181301	64, 146	18228	8422370182285	66, 148	18429	8422370184296	160
18082	8422370180823	193, 255	18131	8422370181318	65, 147	18234	8422370182346	67, 149	18430	8422370184302	160
18084	8422370180847	193, 255	18132	8422370181325	67, 149	18236	8422370182360	66, 148	18432	8422370184326	160
18088	8422370180885	257, 285	18136	8422370181363	67, 149	18246	8422370182469	66, 148	18433	8422370184333	81, 165
18091	8422370180915	189, 249	18139	8422370181394	67, 149	18250	8422370182506	189	18437	8422370184371	81, 165
18092	8422370180922	228, 268	18140	8422370181400	64	18315	8422370183152	152	18446	8422370184463	80
18095	8422370180953	189, 249	18144	8422370181448	64	18317	8422370183176	152	18448	8422370184487	80
18097	8422370180977	189, 249	18148	8422370181486	64	18318	8422370183183	153	18450	8422370184500	80
18099	8422370180991	189, 249	18150	8422370181509	64	18320	8422370183206	153	18520	8422370185200	77, 161
18116	8422370181165	64	18154	8422370181547	64	18322	8422370183220	153	18522	8422370185224	77, 161
18117	8422370181172	65	18158	8422370181585	64	18323	8422370183237	152	18524	8422370185248	77, 161
18118	8422370181189	64, 146	18160	8422370181608	65	18324	8422370183244	153	18526	8422370185262	77, 161
18119	8422370181196	65, 147	18164	8422370181646	65	18325	8422370183251	152	18528	8422370185286	77, 161
18120	8422370181202	64, 146	18168	8422370181684	65	18326	8422370183268	153	18529	8422370185293	77
18121	8422370181219	65, 147	18169	8422370181691	65	18328	8422370183282	153	18530	8422370185309	76, 161
18122	8422370181226	64, 146	18170	8422370181707	65	18329	8422370183299	152	18531	8422370185316	76, 161
18123	8422370181233	65, 147	18172	8422370181721	65	18331	8422370183312	153, 310	18532	8422370185323	76, 161
			18187	8422370181875	257, 285	18333	8422370183336	152			
			18188	8422370181882	257, 285	18418	8422370184180	81, 165			
						18420	8422370184203	81, 165			

Referencia / Reference / Référence / Arkittel

Ref.	EAN	Pág.	Ref.	EAN	Pág.	Ref.	EAN	Pág.	Ref.	EAN	Pág.
18540	8422370185408	76	35330	8422370353302	217	35429	8422370354293	279	50211	8422370502113	41, 101
18542	8422370185422	76	35331	8422370353319	216	35432	8422370354323	279	50215	8422370502151	41, 100
18544	8422370185446	76	35332	8422370353326	217	35435	8422370354354	280			
18546	8422370185460	76	35334	8422370353340	215	35437	8422370354378	279	50217	8422370502175	41, 101
18547	8422370185477	77	35335	8422370353357	215	35439	8422370354392	279	50218	8422370502182	41, 101
18548	8422370185484	76	35336	8422370353364	215	35441	8422370354415	279			
18549	8422370185491	77	35337	8422370353371	215	35442	8422370354422	280	50227	8422370502274	99
18550	8422370185507	76	35338	8422370353388	215	35443	8422370354439	280	50231	8422370502311	259
18618	8422370186184	71, 157	35339	8422370353395	215	35444	8422370354446	280	50234	8422370502342	177
18620	8422370186207	71, 157	35340	8422370353401	217	35445	8422370354453	280	50237	8422370502373	257
			35341	8422370353418	216	35460	8422370354606	233, 277	50244	8422370502441	55, 104
18622	8422370186221	71, 157	35342	8422370353425	216	42052	8422370420523	208	50246	8422370502465	259
18624	8422370186245	71, 157	35343	8422370353432	200						
			35344	8422370353449	214	42072	8422370420721	208	50248	8422370502489	104
18626	8422370186269	71, 157	35345	8422370353456	214						
18628	8422370186283	71, 157	35346	8422370353463	214	42092	8422370420929	209	50250	8422370502502	51
			35347	8422370353470	214						
18631	8422370186313	71, 157	35348	8422370353487	214	50015	8422370500157	200	50253	8422370502533	51
18632	8422370186320	71, 157	35349	8422370353494	214	50016	8422370500164	259	50254	8422370502540	53
			35350	8422370353500	216	50017	8422370500171	200	50260	8422370502601	51
18644	8422370186443	71	35351	8422370353517	210	50037	8422370500379	259	50261	8422370502618	53
18646	8422370186467	71	35352	8422370353524	216	50038	8422370500386	200	50263	8422370502632	51
34434	8422370344348	24, 114	35371	8422370353715	210	50131	8422370501314	259	50264	8422370502649	53
35042	8422370350424	212	35372	8422370353722	210	50134	8422370501345	177	50265	8422370502656	51
			35381	8422370353814	211	50180	8422370501802	99	50270	8422370502700	40
35052	8422370350523	212	35382	8422370353821	210	50200	8422370502007	51	50271	8422370502717	40
35062	8422370350622	212	35383	8422370353838	211	50201	8422370502014	53	50272	8422370502724	40
35072	8422370350721	212	35415	8422370354156	278	50203	8422370502038	51	50273	8422370502731	40
35074	8422370350745	212	35420	8422370354200	279	50204	8422370502045	53	50280	8422370502809	99
35082	8422370350820	212	35422	8422370354224	278	50208	8422370502083	51	51028	8422370510286	133
35092	8422370350929	212	35425	8422370354255	278	50210	8422370502106	51	51038	8422370510385	133
35321	8422370353210	222	35427	8422370354279	278						

Referencia / Reference / Référence / Arkitel

Ref.	EAN	Pág.	Ref.	EAN	Pág.	Ref.	EAN	Pág.	Ref.	EAN	Pág.
51048	8422370510484	133	51291	8422370512914	99	51520	8422370515205	105	51820	8422370518206	119
51119	8422370511191	133	51294	8422370512945	177	51521	8422370515212	54, 136	51824	8422370518244	119
51121	8422370511214	133	51297	8422370512976	99				51828	8422370518282	119
51123	8422370511238	133	51307	8422370513072	99	51523	8422370515236	54, 136	51821	8422370518213	129
51125	8422370511252	133	51308	8422370513089	99	51524	8422370515243	54, 136	51825	8422370518251	129
51127	8422370511276	133	51318	8422370513188	140				51829	8422370518299	129
51129	8422370511290	133	51319	8422370513195	141	51525	8422370515250	105	51833	8422370518336	129
51200	8422370512006	99	51320	8422370513201	140	51527	8422370515274	54, 136	51837	8422370518374	129
51205	8422370512051	101	51321	8422370513218	141	51529	8422370515298	54, 136	51918	8422370519180	163
51207	8422370512075	99	51322	8422370513225	140				51919	8422370519197	163
51220	8422370512204	123	51323	8422370513232	141	51531	8422370515311	105	51920	8422370519203	163
51222	8422370512228	125	51324	8422370513249	140	51600	8422370516004	103	51921	8422370519210	163
51223	8422370512235	123	51325	8422370513256	141	51601	8422370516011	103	51922	8422370519227	163
51225	8422370512259	123	51326	8422370513263	140	51618	8422370516189	122	51923	8422370519234	163
51227	8422370512273	125	51327	8422370513270	141	51620	8422370516202	122	51924	8422370519241	163
51228	8422370512280	123	51328	8422370513287	140	51621	8422370516219	124	51925	8422370519258	163
51229	8422370512297	125	51329	8422370513294	141	51622	8422370516226	122	51926	8422370519265	163
51231	8422370512310	125	51406	8422370514062	106	51623	8422370516233	124	51927	8422370519272	163
51232	8422370512327	123	51410	8422370514109	106	51624	8422370516240	122	51928	8422370519289	163
51235	8422370512358	125	51420	8422370514208	105	51625	8422370516257	124	51929	8422370519296	163
51236	8422370512365	123	51421	8422370514215	137	51626	8422370516264	122	52127	8422370521275	173
51261	8422370512617	259	51422	8422370514222	105	51627	8422370516271	124	52137	8422370521374	173
51267	8422370512679	259	51423	8422370514239	137	51628	8422370516288	122	52157	8422370521572	173
51274	8422370512747	104	51425	8422370514253	137	51629	8422370516295	124	52167	8422370521671	173
51275	8422370512754	55, 104	51426	8422370514260	105	51632	8422370516325	122	52172	8422370521725	173
			51427	8422370514277	137	51640	8422370516400	122	52173	8422370521732	173
51276	8422370512761	104	51428	8422370514284	104	51642	8422370516424	122	52200	8422370522005	172
51277	8422370512778	99	51429	8422370514291	137	51644	8422370516448	122	52201	8422370522012	172
51280	8422370512808	99	51430	8422370514307	105	51724	8422370517247	142	52210	8422370522104	173
51284	8422370512846	177	51436	8422370514369	105	51726	8422370517261	142	52212	8422370522128	173
51285	8422370512853	259	51442	8422370514420	105	51728	8422370517285	142	52220	8422370522203	172
51287	8422370512877	259	51450	8422370514505	105	51732	8422370517322	142	52221	8422370522210	172
						51736	8422370517360	142			

Referencia / Reference / Référence / Arkitel

Ref.	EAN	Pág.	Ref.	EAN	Pág.	Ref.	EAN	Pág.	Ref.	EAN	Pág.
52223	8422370522234	173	53100	8422370531007	243	53240	8422370532400	218	53410	8422370534107	225
52224	8422370522241	173	53101	8422370531014	243, 277	53245	8422370532455	218	53420	8422370534206	225
52226	8422370522265	172	53104	8422370531045	239	53246	8422370532462	218	53430	8422370534305	225
52232	8422370522326	172	53106	8422370531069	258	53247	8422370532479	218	53514	8422370535142	224
52240	8422370522401	172	53107	8422370531076	258	53248	8422370532486	218	53516	8422370535166	224
52242	8422370522425	172	53108	8422370531083	258	53256	8422370532561	206	53518	8422370535180	224
52250	8422370522500	172	53109	8422370531090	276	53330	8422370533308	224	53520	8422370535203	224
52252	8422370522524	172	53110	8422370531106	243, 277	53332	8422370533322	224	53523	8422370535234	224
53007	8422370530079	229, 277	53111	8422370531113	243, 277	53334	8422370533346	224	53525	8422370535258	224
53010	8422370530109	229, 277	53112	8422370531120	240	53336	8422370533360	224	53531	8422370535319	224
53018	8422370530185	177	53113	8422370531137	240	53338	8422370533384	224	53536	8422370535364	224
53020	8422370530208	177	53115	8422370531151	202	53340	8422370533407	224	53610	8422370536101	207
53053	8422370530536	229	53116	8422370531168	240	53342	8422370533421	224	53612	8422370536125	207
53055	8422370530550	229	53117	8422370531175	239	53344	8422370533445	224	53614	8422370536149	207
53056	8422370530567	229	53120	8422370531205	176, 259	53346	8422370533469	224	53616	8422370536163	207
53057	8422370530574	229	53125	8422370531250	199	53350	8422370533506	228	53618	8422370536187	207
53058	8422370530581	229	53176	8422370531762	207	53351	8422370533513	228	53624	8422370536248	207
53059	8422370530598	229	53178	8422370531786	207	53352	8422370533520	228	53630	8422370536309	198, 242
53060	8422370530604	201	53180	8422370531809	207	53354	8422370533544	228	53635	8422370536354	198, 242
53061	8422370530611	252	53182	8422370531823	207	53355	8422370533551	228	53640	8422370536408	199, 242
53062	8422370530628	252	53201	8422370532011	250	53357	8422370533575	228	53641	8422370536415	199, 242
53063	8422370530635	252	53202	8422370532028	250	53360	8422370533605	228	53643	8422370536439	199, 242
53064	8422370530642	253	53203	8422370532035	250	53362	8422370533629	228	53645	8422370536453	199, 242
53067	8422370530673	191, 252	53204	8422370532042	250	53364	8422370533643	228	53646	8422370536460	199, 242
53070	8422370530703	201	53220	8422370532202	201, 219	53366	8422370533667	228	53655	8422370536552	194
53071	8422370530710	201	53221	8422370532219	201, 219	53368	8422370533681	228	53660	8422370536606	194
53080	8422370530802	201	53225	8422370532257	218	53370	8422370533704	228	53661	8422370536613	194
53081	8422370530819	201	53230	8422370532301	218	53372	8422370533728	228	53665	8422370536651	194
53083	8422370530833	309	53235	8422370532356	218	53382	8422370533827	225			
53084	8422370530840	309				53384	8422370533841	225			
						53386	8422370533865	225			
						53396	8422370533964	228			

Referencia / Reference / Référence / Arkitel

Ref.	EAN	Pág.	Ref.	EAN	Pág.	Ref.	EAN	Pág.	Ref.	EAN	Pág.
53666	8422370536668	194	54702	8422370547022	181	55072	8422370550725	266	55309	8422370553092	206
53670	8422370536705	194	54716	8422370547169	180	55073	8422370550732	267	55312	8422370553122	206
53675	8422370536750	194	54720	8422370547206	182	55074	8422370550749	267	55314	8422370553146	206
53676	8422370536767	195	54732	8422370547329	182	55080	8422370550800	270	55316	8422370553160	206
53677	8422370536774	195	54752	8422370547527	182	55085	8422370550855	270	55318	8422370553184	206
53678	8422370536781	195	54754	8422370547541	182	55090	8422370550909	341	55319	8422370553191	206
53708	8422370537085	229	54761	8422370547619	183	55091	8422370550916	341	55320	8422370553207	206
53710	8422370537108	229	55010	8422370550107	270	55092	8422370550923	341	55322	8422370553221	206
53712	8422370537122	229	55028	8422370550282	188, 248, 287	55103	8422370551036	258	55324	8422370553245	206
53714	8422370537146	229				55104	8422370551043	258	55326	8422370553269	206
53716	8422370537160	229	55040	8422370550404	266	55108	8422370551081	178, 258	55350	8422370553504	270
53725	8422370537252	198, 243	55041	8422370550411	266	55110	8422370551104	270	55380	8422370553801	270
53730	8422370537306	198, 243	55042	8422370550428	266	55150	8422370551500	270	55410	8422370554105	271
53735	8422370537351	198, 243	55043	8422370550435	266	55180	8422370551807	270	55420	8422370554204	271
53914	8422370539140	225	55044	8422370550442	266	55185	8422370551852	270	55430	8422370554303	271
53916	8422370539164	225	55045	8422370550459	266	55189	8422370551890	41, 342	55440	8422370554402	271
53919	8422370539195	225	55050	8422370550503	270	55191	8422370551913	41, 342	55441	8422370554419	271
53922	8422370539225	225	55054	8422370550541	267	55192	8422370551920	342	55442	8422370554426	271
53925	8422370539256	225	55055	8422370550558	267	55199	8422370551997	342	55450	8422370554501	271
53972	8422370539720	218	55056	8422370550565	267	55194	8422370551944	342	55451	8422370554518	271
53974	8422370539744	218	55057	8422370550572	341	55195	8422370551951	342	55452	8422370554525	271
53976	8422370539768	218	55058	8422370550589	341	55196	8422370551968	342	55460	8422370554600	271
53978	8422370539782	218	55059	8422370550596	341	55197	8422370551975	342	55470	8422370554709	271
53990	8422370539904	202	55060	8422370550602	341	55198	8422370551982	41	56003	8422370560038	252
53991	8422370539911	218	55062	8422370550626	341	55199	8422370551997	342	56007	8422370560076	252
53995	8422370539959	218	55063	8422370550633	341	55198	8422370551982	41	56061	8422370560618	252
53996	8422370539966	202	55064	8422370550640	341	55210	8422370552101	270	56063	8422370560632	252
53997	8422370539973	218	55065	8422370550657	341	55220	8422370552200	270	56065	8422370560656	252
54696	8422370546964	181	55066	8422370550664	341	55230	8422370552309	270	58043	8422370580432	309
54698	8422370546988	181	55070	8422370550701	178	55231	8422370552316	268	58045	8422370580456	309
54700	8422370547008	181	55071	8422370550718	266	55250	8422370552507	270	59006	8422370590066	253
						55261	8422370552613	268	59007	8422370590073	253
						55280	8422370552804	270			

Referencia / Reference / Référence / Arkitel

Ref.	EAN	Pág.	Ref.	EAN	Pág.	Ref.	EAN	Pág.	Ref.	EAN	Pág.
59014	8422370590141	247, 287	59078	8422370590783	192, 254	59187	8422370591872	256, 284	60051	8422370600512	93
59015	8422370590158	188, 248, 287	59079	8422370590790	190	59188	8422370591889	256, 284	60052	8422370600529	93
			59080	8422370590806	192, 254				60053	8422370600536	93
59016	8422370590165	247, 287	59081	8422370590813	190	59189	8422370591896	256, 284	60054	8422370600543	93
			59082	8422370590820	192, 254				60072	8422370600727	93
59017	8422370590172	188, 248, 287	59084	8422370590844	192, 254	59190	8422370591902	256, 284	60074	8422370600741	93
			59088	8422370590882	256, 284	59199	8422370591995	188	60076	8422370600765	93
59018	8422370590189	247, 287	59089	8422370590899	188, 248	59211	8422370592114	272	60078	8422370600789	93
			59091	8422370590912	188, 248	59248	8422370592480	246, 286	60080	8422370600802	93
59019	8422370590196	188, 248, 287	59092	8422370590929	246, 286	59249	8422370592497	246, 286	60100	8422370601007	92
			59095	8422370590950	188, 248	59250	8422370592503	188	60102	8422370601021	92
59043	8422370590431	188, 248	59097	8422370590974	188, 248	59251	8422370592510	246, 286	60104	8422370601045	92
59045	8422370590455	188, 248	59099	8422370590998	188, 248	59252	8422370592527	246, 286	60105	8422370601052	95, 104
			59101	8422370591018	274	59254	8422370592541	247, 287	60106	8422370601069	92
59047	8422370590479	188, 248	59102	8422370591025	274	59270	8422370592701	191	60107	8422370601076	95, 104
59049	8422370590493	188, 248	59103	8422370591032	274	59271	8422370592718	190, 287	60108	8422370601083	92
			59105	8422370591056	274	59272	8422370592725	190, 287	60109	8422370601090	95, 104
59054	8422370590547	192, 254	59106	8422370591063	275	59280	8422370592800	257, 285	60110	8422370601106	92
59056	8422370590561	192, 254	59107	8422370591070	274	59282	8422370592824	257, 267	60111	8422370601113	95, 104
			59109	8422370591098	188, 248	59290	8422370592909	256, 284	60113	8422370601137	95, 104
59060	8422370590608	256, 284	59117	8422370591179	275	59351	8422370593517	288	60115	8422370601151	95, 104
59062	8422370590622	256, 284	59150	8422370591506	273	59352	8422370593524	288	60118	8422370601182	100
			59151	8422370591513	273	59410	8422370594101	200	60142	8422370601427	94, 167
59068	8422370590684	192, 254	59152	8422370591520	273	59412	8422370594125	200	60144	8422370601441	94, 167
59070	8422370590707	192, 254	59153	8422370591537	273	59414	8422370594149	200	60145	8422370601458	95, 167
			59154	8422370591544	273	60041	8422370600413	92, 310	60146	8422370601465	94, 167
59072	8422370590721	192, 254	59155	8422370591551	273						
			59157	8422370591575	273						
59074	8422370590745	192, 254									
59075	8422370590752	190									
59076	8422370590769	192, 254									
59077	8422370590776	190									

Referencia / Reference / Référence / Arkittel

Ref.	EAN	Pág.	Ref.	EAN	Pág.	Ref.	EAN	Pág.	Ref.	EAN	Pág.
60147	8422370601472	95, 167	60252	8422370602523	93	60618	8422370606187	90	60858	8422370608587	88
60148	8422370601489	94, 167	60314	8422370603148	95, 167	60620	8422370606200	90	60860	8422370608600	88
			60316	8422370603162	95, 167	60622	8422370606224	90	60864	8422370608648	88
60158	8422370601588	94, 167	60318	8422370603186	95, 167	60624	8422370606248	90	60874	8422370608747	89
60160	8422370601601	94, 167				60644	8422370606446	91	60876	8422370608761	89
60162	8422370601625	94	60320	8422370603209	95, 167	60646	8422370606460	91	60878	8422370608785	89
			60322	8422370603223	95, 167	60648	8422370606484	91	60880	8422370608808	89
60163	8422370601632	94, 167	60324	8422370603247	95, 167	60650	8422370606507	91	60882	8422370608822	89
60164	8422370601649	94, 167				60652	8422370606521	91	60884	8422370608846	89
60168	8422370601687	94, 167	60328	8422370603285	95, 167	60654	8422370606545	91	60944	8422370609447	89
			60400	8422370604008	92	60716	8422370607160	90	60946	8422370609461	89
60191	8422370601915	93				60718	8422370607184	90	60948	8422370609485	89
60193	8422370601939	93	60402	8422370604022	92	60720	8422370607207	90	60950	8422370609508	89
60195	8422370601953	93				60724	8422370607245	90	60952	8422370609522	89
60197	8422370601977	93	60404	8422370604046	92	60746	8422370607467	91	60954	8422370609546	89
			60406	8422370604060	92	60748	8422370607481	91	60966	8422370609669	89
60198	8422370601984	92	60408	8422370604084	92	60750	8422370607504	91	60968	8422370609683	89
60199	8422370601991	93	60410	8422370604107	92	60754	8422370607542	91	60970	8422370609706	89
60200	8422370602004	92	60514	8422370605142	90	60814	8422370608143	88	60974	8422370609744	89
60202	8422370602028	92, 100	60516	8422370605166	90	60816	8422370608167	88	60990	8422370609904	311
			60518	8422370605180	90	60818	8422370608181	88	60995	8422370609959	311
60204	8422370602042	92	60520	8422370605203	90	60820	8422370608204	88	61010	8422370610108	179
60206	8422370602066	92	60522	8422370605227	90	60822	8422370608228	88	61011	8422370610115	179
60208	8422370602080	92	60524	8422370605241	90	60824	8422370608242	88	61020	8422370610207	253
60210	8422370602103	92	60544	8422370605449	91	60834	8422370608341	88	61023	8422370610238	251
60217	8422370602172	100	60546	8422370605463	91	60836	8422370608365	88	61030	8422370610306	235
60218	8422370602189	101	60548	8422370605487	91	60838	8422370608389	88	61036	8422370610368	250
60219	8422370602196	101	60550	8422370605500	91	60840	8422370608402	88	61037	8422370610375	250
60246	8422370602462	93	60552	8422370605524	91	60842	8422370608426	88	61038	8422370610382	250
60248	8422370602486	93	60554	8422370605548	91	60844	8422370608440	88	61050	8422370610504	244
60250	8422370602509	93	60614	8422370606149	90	60856	8422370608563	88	61061	8422370610610	235
60251	8422370602516	93	60616	8422370606163	90						

Referencia / Reference / Référence / Arkittel

Ref.	EAN	Pág.	Ref.	EAN	Pág.	Ref.	EAN	Pág.	Ref.	EAN	Pág.
61114	8422370611143	309	61186	8422370611860	305	61242	8422370612423	306	62128	8422370621289	36
61116	8422370611167	309	61187	8422370611877	294	61326	8422370613260	179, 264	62130	8422370621302	36
61117	8422370611174	59, 308	61188	8422370611884	305	61328	8422370613284	179, 264	62132	8422370621326	36
61120	8422370611204	309	61189	8422370611891	294				62216	8422370622163	37
61124	8422370611242	309	61190	8422370611907	298	61462	8422370614625	186	62224	8422370622248	37
61134	8422370611341	304	61198	8422370611983	300	61463	8422370614632	186	62228	8422370622286	37
61135	8422370611358	304	61199	8422370611990	300	61468	8422370614687	186	62232	8422370622323	37
61136	8422370611365	304	61201	8422370612010	301	61470	8422370614700	186	62316	8422370623160	37
61143	8422370611433	306	61202	8422370612027	301	61706	8422370617060	223	62320	8422370623207	36
61144	8422370611440	305	61203	8422370612034	299	61708	8422370617084	221	62324	8422370623245	36
61146	8422370611464	305	61204	8422370612041	299	61711	8422370617114	223	62328	8422370623283	36
61155	8422370611556	304	61206	8422370612065	300	61712	8422370617121	223	62332	8422370623320	36
61156	8422370611563	304	61207	8422370612072	302	61714	8422370617145	223	62816	8422370628165	37
61157	8422370611570	301	61209	8422370612096	295	61716	8422370617169	220	62818	8422370628189	37
61158	8422370611587	292	61211	8422370612119	301	61717	8422370617176	220	62820	8422370628202	37
61160	8422370611600	302	61212	8422370612126	302	61718	8422370617183	220	62822	8422370628226	37
61161	8422370611617	298	61213	8422370612133	298	62016	8422370620169	36	62824	8422370628240	37
61162	8422370611624	301	61215	8422370612157	300	62018	8422370620183	36	62826	8422370628264	37
61163	8422370611631	302	61220	8422370612201	259	62020	8422370620206	36	62828	8422370628288	37
61164	8422370611648	300	61222	8422370612225	259	62022	8422370620220	36	62830	8422370628301	37
61167	8422370611679	302	61224	8422370612249	259	62024	8422370620244	36	62832	8422370628325	37
61168	8422370611686	301	61230	8422370612300	263, 282	62026	8422370620268	36	63118	8422370631189	54
61169	8422370611693	298	61231	8422370612317	263	62028	8422370620282	36	64018	8422370640181	55
61177	8422370611778	292	61232	8422370612324	262, 283	62030	8422370620305	36	64024	8422370640242	50
61179	8422370611792	292	61233	8422370612331	262, 283	62032	8422370620329	36	64034	8422370640341	52
61180	8422370611808	294	61234	8422370612348	262, 283	62116	8422370621166	36	64114	8422370641140	50
61181	8422370611815	294	61235	8422370612355	262, 283	62118	8422370621180	36	64118	8422370641188	50
61182	8422370611822	305	61240	8422370612409	263, 282	62120	8422370621203	36	64124	8422370641249	52
61183	8422370611839	298				62122	8422370621227	36	65018	8422370650180	50
61184	8422370611846	305				62124	8422370621241	36	65019	8422370650197	50
61185	8422370611853	300				62126	8422370621265	36	65020	8422370650203	50

Referencia / Reference / Référence / Arkittel

Ref.	EAN	Pág.	Ref.	EAN	Pág.	Ref.	EAN	Pág.	Ref.	EAN	Pág.
65022	8422370650227	50	65394	8422370653945	20	65605	8422370656052	18	65663	8422370656632	19
65025	8422370650258	52	65398	8422370653983	20	65607	8422370656076	18	65665	8422370656656	19
65026	8422370650265	50	65420	8422370654201	54	65609	8422370656090	18	65666	8422370656663	19
65027	8422370650272	55	65422	8422370654225	54	65611	8422370656113	18	65670	8422370656700	19
65028	8422370650289	52	65424	8422370654249	54	65613	8422370656137	18	65677	8422370656779	19
65029	8422370650296	52	65561	8422370655611	31	65616	8422370656168	21	65679	8422370656793	19
65031	8422370650319	50	65562	8422370655628	31	65620	8422370656205	21	65680	8422370656809	19
65032	8422370650326	52	65563	8422370655635	31	65621	8422370656212	18	65681	8422370656816	19
65036	8422370650364	52	65564	8422370655642	31	65622	8422370656229	18	65683	8422370656830	19
65041	8422370650418	52	65565	8422370655659	31	65623	8422370656236	18	65685	8422370656854	19
65043	8422370650432	52	65568	8422370655680	31	65624	8422370656243	21	65687	8422370656878	19
65066	8422370650661	311	65569	8422370655697	31	65625	8422370656250	18	65689	8422370656892	19
65118	8422370651187	50	65570	8422370655703	31	65627	8422370656274	18	65691	8422370656915	23
65119	8422370651194	50	65571	8422370655710	31	65628	8422370656281	18	65692	8422370656922	23
65122	8422370651224	50	65572	8422370655727	31	65629	8422370656298	18	65693	8422370656939	23
338 65126	8422370651262	50	65573	8422370655734	31	65631	8422370656311	18	65695	8422370656953	23
65128	8422370651286	52	65574	8422370655741	31	65633	8422370656335	18	65697	8422370656977	23
65129	8422370651293	52	65575	8422370655758	31	65635	8422370656359	18	65698	8422370656984	22
65130	8422370651309	50	65576	8422370655765	31	65636	8422370656366	21	65699	8422370656991	19
65132	8422370651323	52	65577	8422370655772	31	65637	8422370656373	18	65700	8422370657004	22
65136	8422370651361	52	65578	8422370655789	31	65638	8422370656380	21	65701	8422370657011	23
65140	8422370651408	52	65579	8422370655796	31	65640	8422370656403	21	65702	8422370657028	23
65216	8422370652160	51	65580	8422370655802	31	65644	8422370656441	21	65703	8422370657035	23
65218	8422370652184	55	65597	8422370655970	18	65649	8422370656496	19	65705	8422370657059	23
65219	8422370652191	55	65598	8422370655987	18	65650	8422370656502	19	65707	8422370657073	23
65220	8422370652207	53, 163	65599	8422370655994	18	65651	8422370656519	19	65708	8422370657080	23
65226	8422370652269	53	65600	8422370656007	18	65653	8422370656533	19	65709	8422370657097	23
65318	8422370653181	54	65601	8422370656014	18	65655	8422370656557	19	65711	8422370657110	23
65320	8422370653204	54	65602	8422370656021	18	65656	8422370656564	19	65713	8422370657134	23
65338	8422370653389	54, 100	65603	8422370656038	18	65657	8422370656571	19	65715	8422370657158	23
			65604	8422370656045	18	65659	8422370656595	19	65718	8422370657189	25, 115
						65661	8422370656618	19			

Referencia / Reference / Référence / Arkitel

Ref.	EAN	Pág.	Ref.	EAN	Pág.	Ref.	EAN	Pág.	Ref.	EAN	Pág.
65719	8422370657196	24, 114	65756	8422370657561	25	65984	8422370659848	55	67138	8422370671383	22
65720	8422370657202	25, 115	65757	8422370657578	24	65985	8422370659855	95	67139	8422370671390	20
			65758	8422370657585	25	65986	8422370659862	55	67140	8422370671406	20
65721	8422370657219	24, 114	65759	8422370657592	24	65988	8422370659886	55	67141	8422370671413	22
			65768	8422370657684	20	65990	8422370659909	55	67142	8422370671420	20
65722	8422370657226	25, 115	65801	8422370658018	20	65992	8422370659923	55	67144	8422370671444	20
			65802	8422370658025	20	66018	8422370660189	50	67148	8422370671482	52
65723	8422370657233	24, 114	65803	8422370658032	20	66020	8422370660202	50	67218	8422370672182	51
			65804	8422370658049	20	66025	8422370660257	52	67228	8422370672281	53
65724	8422370657240	25, 115	65805	8422370658056	20	66028	8422370660288	52	67513	8422370675138	176
			65806	8422370658063	20	66118	8422370661186	50	67515	8422370675152	176
65725	8422370657257	25, 114	65807	8422370658070	20	66128	8422370661285	52	67519	8422370675190	176
			65808	8422370658087	20	66218	8422370662183	51	67523	8422370675237	176
65726	8422370657264	25, 115	65811	8422370658117	20	66222	8422370662220	51	67527	8422370675275	176
			65812	8422370658124	20	66226	8422370662268	51	67528	8422370675282	176
65727	8422370657271	24, 114	65813	8422370658131	20	66228	8422370662282	53	67529	8422370675299	163
			65814	8422370658148	55	66230	8422370662305	51	67531	8422370675312	176
65728	8422370657288	25, 115	65818	8422370658186	55	66232	8422370662329	53	67532	8422370675329	176
			65819	8422370658193	55	66236	8422370662367	53	67533	8422370675336	163
65729	8422370657295	24, 114	65918	8422370659183	311	66240	8422370662404	53	67535	8422370675350	176
			65923	8422370659237	311	66242	8422370662428	53	67536	8422370675367	176
65730	8422370657303	25, 115	65974	8422370659749	55	66818	8422370668185	55, 104	67537	8422370675374	163
			65975	8422370659756	95	67018	8422370670188	50	67628	8422370676289	176
65731	8422370657318	24, 114	65976	8422370659763	55	67020	8422370670201	50	67629	8422370676296	176, 272
			65977	8422370659770	95	67022	8422370670225	102	67630	8422370676302	176
65732	8422370657325	25, 115	65978	8422370659787	55	67024	8422370670249	102	67632	8422370676326	176
			65979	8422370659794	95	67025	8422370670256	52	67633	8422370676333	176, 272
65733	8422370657332	25, 115	65980	8422370659800	55	67026	8422370670263	102	67634	8422370676340	176
			65981	8422370659817	95	67028	8422370670287	52	67721	8422370677217	175
65734	8422370657347	25	65982	8422370659824	55	67118	8422370671185	50	67722	8422370677224	175
			65983	8422370659831	95	67134	8422370671345	22	67723	8422370677231	175
65735	8422370657354	24				67136	8422370671369	21			

Referencia / Reference / Référence / Arkitel

Ref.	EAN	Pág.	Ref.	EAN	Pág.
67731	8422370677316	175	68818	8422370688183	55, 104
67732	8422370677323	175	68820	8422370688206	55
67733	8422370677330	175	69018	8422370690186	50
67737	8422370677378	175	69020	8422370690209	50
67738	8422370677385	175	69025	8422370690254	52
67739	8422370677392	175	69118	8422370691183	50
67740	8422370677408	174	69128	8422370691282	52
67742	8422370677422	175	69218	8422370692180	51
67743	8422370677439	175	69818	8422370698182	55
67751	8422370677514	175	70932	8422370709321	18, 114
67761	8422370677613	175	70933	8422370709338	19, 115
67762	8422370677620	175	70936	8422370709369	18, 114
67763	8422370677637	175	70937	8422370709376	19, 115
68018	8422370680187	50	70940	8422370709406	18, 114
68020	8422370680200	50	70941	8422370709413	19, 115
68025	8422370680255	52	90168	8422370901688	190
68028	8422370680286	52	99077	8422370990774	176, 259
68118	8422370681184	50			
68128	8422370681283	52			
68218	8422370682181	51			
68228	8422370682280	53			

340

Para crear el **CÓDIGO EAN-13** de cualquier producto Inoxibar:

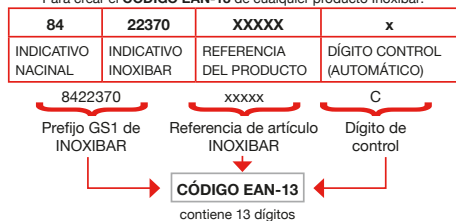

To create an **EAN-13 CODE** for any Inoxibar product:

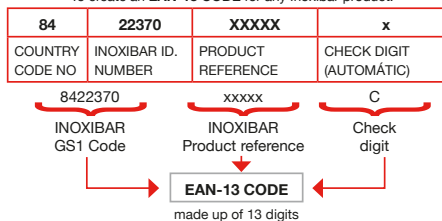

Repuestos

Spare parts
Pièces détachées
Ersatzteile

	Ref.	€
Mangos de repuesto · Manches de rechange Spare handles · handgriff	55090	4,61
Asas de repuesto · Poignées de rechange Spare ears · griffe	55091	4,61
Pomos y arandelas · Boutons et rondelles Knobs and washers · knopf /unterteil	55092	4,61
Filtro superior cafetera 4 tazas · Filtre supérieur pour cafetière 4 tasses Top filter for 4-cup coffeepot · Oberer Filter Kaffeemaschine 4 Tassen	55057	1,81
Filtro superior cafetera 6 tazas · Filtre supérieur pour cafetière 6 tasses Top filter for 6-cup coffeepot · Oberer Filter Kaffeemaschine 6 Tassen	55058	2,43
Filtro superior cafetera 10 tazas · Filtre supérieur pour cafetière 10 tasses Top filter for 10-cup coffeepot · Oberer Filter Kaffeemaschine 10 Tassen	55059	2,68
Filtro reductor cafetera 4 tazas · Filtre réducteur pour cafetière 4 tasses Restrictor filter for 4-cup coffeepot · Reduktionsfilter Kaffeemaschine 4 Tassen	55060	1,33
Filtro reductor cafetera 6 tazas · Filtre réducteur pour cafetière 6 tasses Restrictor filter for 6-cup coffeepot · Reduktionsfilter Kaffeemaschine 6 Tassen	55061	1,64
Filtro reductor cafetera 10 tazas · Filtre réducteur pour cafetière 10 tasses Restrictor filter for 10-cup coffeepot · Reduktionsfilter Kaffeemaschine 10 Tassenmaker	55062	1,81
Válvula suelta para cafeteras · Soupape seule pour cafetiéres Spare valve for coffeepots · Ventil für Kaffeemaschinen	55063	0,89
Cargador suelto cafetera 4 tazas · Filtre porte-café seul pour cafetière 4 tasses Spare pot for 4-cup coffeepot · Filterhalter Kaffeemaschine 4 Tassen	55064	4,06
Cargador suelto cafetera 6 tazas · Filtre porte-café seul pour cafetière 6 tasses Spare pot for 6-cup coffeepot · Filterhalter Kaffeemaschine 6 Tassen	55065	4,34
Cargador suelto cafetera 10 tazas · Filtre porte-café seul pour cafetière 10 tasses Spare pot for 10-cup coffeepot · Filterhalter Kaffeemaschine 10 Tassen	55066	4,54

341

Juntas

Joints
Rings
Gummidichtung

	Ref.	€
Dos juntas de silicona cafetera 4 tazas Two Silicone ring for 4-cup coffeepot Deux joint en silicone pour cafetière 4 tasses Zwei Silikondichtung kaffeemaschine 4 Tassen	55054	1,80
Dos Juntas de silicona cafetera 6 tazas Two silicone ring for 6-cup coffeepot Deux joint en silicone pour cafetière 6 tasses Zwei Silikondichtung Kaffeemaschine 6 Tassen	55055	2,11
Dos juntas de silicona cafetera 10 tazas Two silicone ring for 10-cup coffeepot Deux joint en silicone pour cafetière 10 tasses Zwei Silikondichtung Kaffeemaschine 10 Tassen	55056	2,34



Repuestos G-SOLA

G-SOLA spare parts
Pièces détachées G-SOLA
Ersatzteile G-SOLA

		Ref.	€
	Junta silicona olla a presión G-Sola G-Sola pressure cooker silicone ring Joint silicone cocotte à pression G-Sola Deckeldichtung schnellkochtopf G-Sola	24cm 55189	12,95
	Junta silicona olla a presión G-Sola G-Sola pressure cooker silicone ring Joint silicone cocotte à pression G-Sola Deckeldichtung schnellkochtopf G-Sola	22cm 55191	11,41
	Asa lateral olla G-Sola G-Sola handle side poignee G-Sola Hinterer handgriff G-Sola	55192	6,82
	Válvula regulacion presion G-Sola Pressure reg. Valve G-Sola soupape regulation pression G-Sola Druckregelventil G-Sola	55193	14,85
	Valvula de seguridad G-Sola Safety valve G-Sola soupape de securite G-Sola Sicherheitsventil G-Sola	55194	9,56
	Sensor indicador de presión G-Sola Indicator valve G-Sola indicateur pression G-Sola Druckanzeiger G-Sola	55195	11,41
342	Mango superior G-Sola Upper handle G-Sola poignee de cuve G-Sola Schnellkochtopf griff oben G-Sola	55196	34,35
	Mango inferior G-Sola Lower handle G-Sola poignee inferieure G-Sola Schnellkochtopf griff unten G-Sola	55197	10,27
	Cesta perforada-colador + soporte Colander-strainer + sup Panier perforé-passoire + support gelochter Korb-Durchschlag + Ständer	altura 7,5cm 50217	10,85
	Cesta perforada-colador + soporte Colander-strainer + sup Panier perforé-passoire + support gelochter Korb-Durchschlag + Ständer	altura 4,5cm 50218	9,95





Passión

por la **cocina**

Passion for Cooking
Passion pour la Cuisine
Liebe zur Küche



Pasión

por la **cocina**

Passion for Cooking
Passion pour la Cuisine
Liebe zur Küche



Polígono Industrial de EITUA N°19
48240 Berriz (Bizkaia) - SPAIN
(+34) 946 82 48 75 - info@inoxibar.com

www.inoxibar.com

