

100 years

pujadas[®]
A VOLLRATH[®] COMPANY

2022

NUEVA HERRAMIENTA DE GESTIÓN

NEW MANAGEMENT TOOL

NOUVEL OUTIL DE GESTION

NEUES MANAGEMENT-TOOL



www.pujadas.es



- **Buscador de producto potente e inteligente**
 - **Toda la información a tu alcance: promociones, pedidos, facturas, fichas técnicas, imágenes, catálogos...**
 - **Información de cliente personalizada y actualizada**
-
- *Powerful, smart product finder*
 - *All the information at your fingertips: promotions, orders, invoices, datasheets, images, catalogues and more.*
 - *Personalized and up-to-date customer information*
-
- **Moteur de recherche de produit puissant et intelligent**
 - **Toutes les informations à votre portée : promotions, commandes, factures, fiches techniques, images, catalogues...**
 - **Information relative au client personnalisée et mise à jour**
-
- *Leistungsstarker und intelligenter Produktfinder*
 - *Alle Informationen für Sie griffbereit: Sonderangebote, Bestellungen, Rechnungen, technische Datenblätter, Bilder, Kataloge ...*
 - *Personalisierte und aktualisierte Kundeninformationen*



**¡Participa de
nuestras redes
sociales!**

Join us on our social networks!

Participez à nos réseaux sociaux !

*Treten Sie unseren sozialen
Netzwerken bei!*

100 years

ESTA ES NUESTRA HISTORIA

THIS IS OUR HISTORY

C'EST NOTRE HISTOIRE

DAS IST UNSERE GESCHICHTE

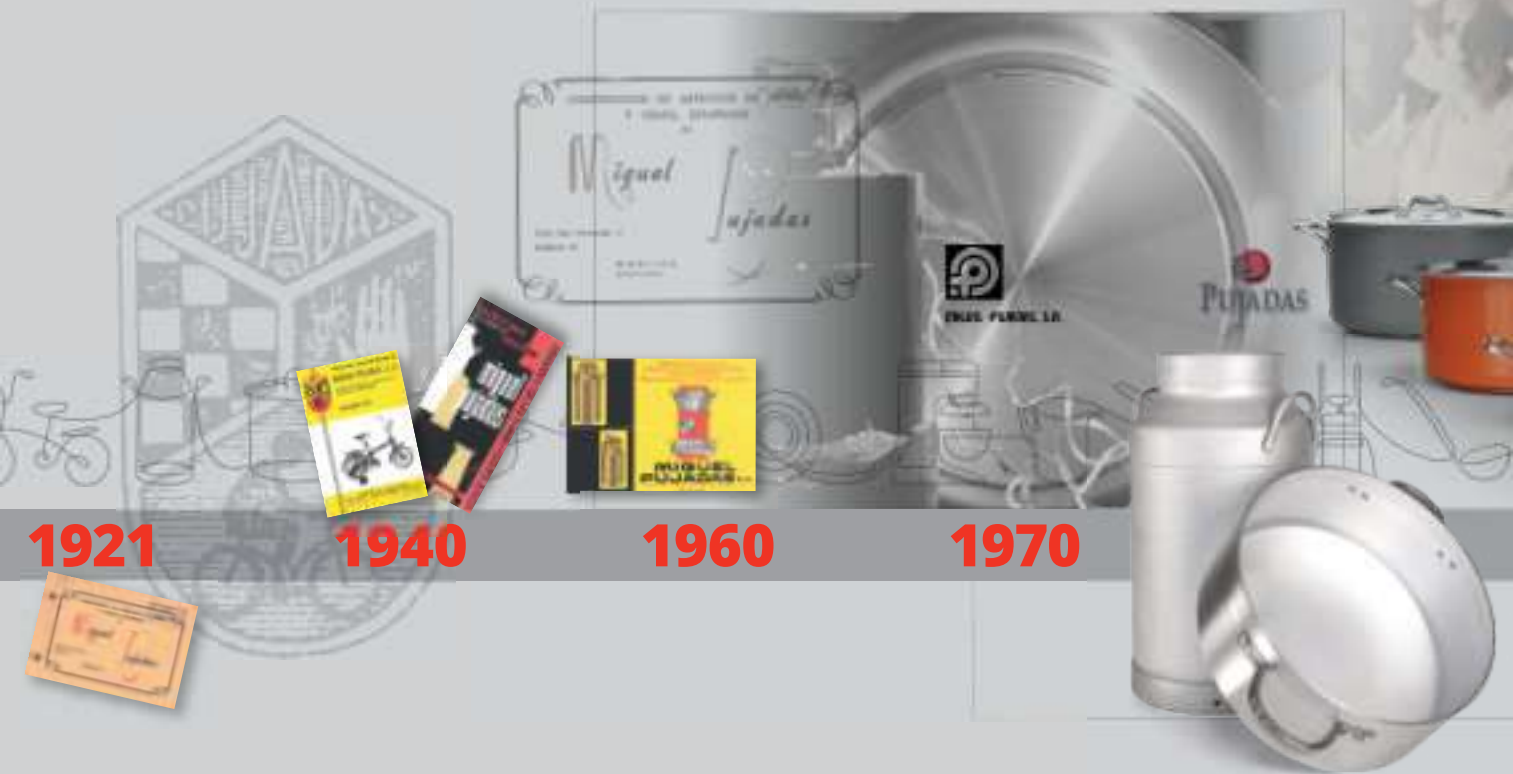

1921

1940

1960

1970

1921

Nace en Manlleu la empresa Miguel Pujadas SA

The company Miguel Pujadas SA is born in Manlleu

Naissance de l'entreprise Miguel Pujadas S.A. à Manlleu

Das Unternehmen Miguel Pujadas SA wurde in Manlleu gegründet.

1940

Diversifica sus productos: lecheras, triciclos y utensilios de cocina

Diversification of the product range: milk jugs, tricycles and kitchen utensils

Diversification de produit : Pots à lait, tricycles et ustensiles de cuisine

Produktdiversifizierung: Milchkannen, Dreiräder und Küchenutensilien

1960

Se especializa en la fabricación por embutición y repulsado

The company specializes manufacturing in drawing and spinning

Se spécialise dans la fabrication par emboutissage et repoussage

Spezialisierung auf die Fertigung im Tiefzieh- und Drehverfahren

1970

Se consolida como expertos en baterías de cocina y complementos

Consolidation as experts in kitchen cookware and accessories

Consolidation en tant qu'experts en batterie de cuisine et accessoires

Etablierung als Spezialist für Kochgeschirr und Zubehör

1999

Se traslada a Santa Coloma de Farners con 20.000m²

Is transferred to Santa Coloma de Farners with 20.000m²

Déménagement à Santa Coloma de Farners avec 20.000m²

Umzug nach Santa Coloma de Farners, Werk mit einer Fläche von 20.000 m²



1999

2015

2019

2020

2021

VOLLRATH®

2015

Entra a formar parte del grupo americano Vollrath

Become part of the american group Vollrath

Rejoint le groupe américain Vollrath

Eintritt in die amerikanische Unternehmensgruppe Vollrath

2019

Amplia sus instalaciones para la fabricación de carros y estanterías

New facilities for the trolley and racking lines

Nouvelles installations pour la fabrication de chariots et d'étagères

Neue Werke für die Herstellung von Servierwagen und Regalen

2020

Presenta sus nuevos hornos de brasa Pujadas Grill

Presents its new Pujadas Grill charcoal ovens

Présente ses nouveaux fours à braise Pujadas Grill

Markteinführung der neuen Pujadas Grill-Holz Kohleöfen

2021

Celebra el primer centenario con la fuerza de una marca consolidada

Celebrates the first centenary with the strength of a consolidated brand

Fête le premier centenaire avec la force d'une marque consolidée

Feier zum hundertjährigen Jubiläum mit der Stärke einer konsolidierten Marke

1921

Manufacturing since 1921 for the culinary world



LA FUERZA DE UN LÍDER

THE STRENGTH OF A LEADER LA FORCED'UN LEADER DIE STÄRKE EINES MARKTFÜHRERS



LA EXPERIENCIA DE UN FABRICANTE

THE EXPERIENCE OF A MANUFACTURER L'EXPÉRIENCED'UNFABRICANT DIE ERFAHRUNG EINES HERSTELLERS



1
Fábrica - Sede
Factory - Headquarters
Usine - Siège
Werk - Sitz



2
Hornos y barbacoas
Ovens and barbecues
Fours et barbecues
Öfen und Grillgeräte



3
Cubic
Cubic
Cubic
Cubic



4
Carros y Estanterías
Trolleys and Shelving
Chariots et Étagères
Wagen und Regale



5
Plástico
Plastic
Plastique
Kunststoff

Desde 2015 somos parte del grupo Vollrath, líder mundial en todo tipo de negocios. Vendemos en más de 100 países y contamos con instalaciones en USA, México, Europa y Asia.

Since 2015, we have been part of the Vollrath group, a world leader in all types of businesses. We sell in more than 100 countries and have facilities in the USA, Mexico, Europe and Asia.

Depuis 2015, nous appartenons au groupe Vollrath, leader mondial dans toutes sortes d'activités. Nous vendons dans plus de 100 pays et nous possédons des installations aux États-Unis, au Mexique, en Europe et en Asie.

Seit 2015 sind wir Teil der Vollrath Unternehmensgruppe, eines weltweiten Marktführers in zahlreichen Geschäftsbereichen. Wir verkaufen in mehr als 100 Ländern und haben Niederlassungen in den USA, Mexiko, Europa und Asien.

CIFRAS CLAVE

KEY FIGURES

CHIFFRES CLÉS

SCHLÜSSELZIFFERN

25.000

M² superficie en España
M² surface in Spain
M² superficie en Espagne
M² Fläche in Spanien

200

Trabajadores (1.500 a nivel mundial)
Workers (1.500 worldwide)
Employés (1.500 au niveau mondial)
Mitarbeiter (1.500 weltweit)

35

Millones de € (60% exportación)
Millions of euros (60% export)
Millions d'€ (60% exportation)
Millionen in € (60 % Export)

+100

Países EMEA+ Oceanía
EMEA + Oceania Countries
Région EMEA+ Océanie
EMEA-Länder + Ozeanien

MEDIO AMBIENTE

ENVIRONMENT

ENVIRONNEMENT

UMWELT



Sostenibilidad
Sustainability
Durabilité
Nachhaltigkeit



Energías renovables
Renewable energy
Énergies Renouvelables
Erneuerbare Energien



Inox 100% reciclado
100% recycled stainless steel
Inox 100 % recyclé
100 % recycelter Edelstahl



Tratamiento de aguas
Water treatment
Traitements des eaux
Wasseraufbereitung



Energéticamente eficientes
Energy efficient
Énergétiquement efficaces
Energieeffizient

CALIDAD

QUALITY

QUALITÉ

QUALITÄT



Apto para contacto con alimentos
Food Contact Approved
Adapté au contact alimentaire
Lebensmittelkontakt zugelassen



Organización para la Salud y Seguridad Pública
Public Health and Safety
Santé et Sécurité Publiques
Öffentliche Gesundheit und Sicherheit



Sistema de Calidad
Quality System
Système de management de la Qualité
Qualitätssystem



Sistema de Calidad
Quality System
Système de management de la Qualité
Qualitätssystem



Garantía de por vida
Guaranteed for life
Garantie à vie
Lebenslange Garantie

NUESTRO OBJETIVO

OUR GOAL / NOTRE OBJECTIF / UNSER ANLIEGEN

SOLUCIONES ESPECIALIZADAS

Desarrollamos productos innovadores que buscan la eficiencia energética, la durabilidad y el control de la merma alimentaria para aumentar la rentabilidad de cada tipo de negocio.

SPECIALIZED SOLUTIONS

We develop innovative products that seek out energy efficiency, durability and the control of food waste to increase the profitability of each type of business.

SOLUTIONS SPÉCIALISÉES

Nous développons des produits innovants axés sur l'efficacité énergétique, la durabilité et le contrôle du gaspillage alimentaire pour d'accroître la rentabilité de chaque activité.

SPEZIALLÖSUNGEN

Wir entwickeln innovative Produkte, die auf Energieeffizienz, Langlebigkeit und Kontrolle von Lebensmittelvergeudung ausgerichtet sind, um die Rentabilität des jeweiligen Geschäfts zu steigern.



HOTELERÍA
HOTELS
HÔTELLERIE
HOTELLERIE



RESTAURACIÓN
RESTAURANTS
RESTAURATION
GASTSTÄTTENGEWERBE



RESTAURACIÓN ORGANIZADA
RESTAURANTS CHAINS
RESTAURATION ORGANISÉE
GASTRONOMIEKETTEN



COLECTIVIDADES
INSTITUTIONS
COLLECTIVITÉS
GEMEINSCHAFTS-VERPFLEGUNG



BAR Y CAFETERÍA
BARS AND CAFÉS
BAR ET CAFÉTERIA
BAR UND CAFETERIA



CÁTERING Y EVENTOS
CATERING AND EVENTS
CATERING ET ÉVÈNEMENTS
CATERING UND VERANSTALTUNGEN



CRUCEROS
CRUISES
BATEAUX DE CROISIÈRES
KREUZFAHRTEN



PARQUES TEMÁTICOS
THEME PARKS
PARCS THÉMATIQUES
THEMENPARKS



MERCAURANTES
GROCERANTS
GROCERANTS
SUPERMÄRKTE MIT KÜCHE



RETAIL
RETAIL
QUINCAILLERIES
EISENWARENGESCHÄFTE

SOLUCIONES GLOBALES

Como fabricantes de menaje, sistemas de almacenaje, transporte y equipamiento ofrecemos soluciones globales, transversales y de confianza a los profesionales del Foodservice.

SPECIALIZED SOLUTIONS

As manufacturers of utensils, storage, transport and equipment systems we provide global, far-reaching and trusted solutions to Foodservice professionals.

SOLUTIONS SPÉCIALISÉES

Entant que fabricants d'ustensiles, de systèmes de stockage de transport et d'équipement nous proposons des solutions globales, transversales et fiables aux professionnels du Foodservice.

SPEZIALLÖSUNGEN

Als Hersteller von Küchenbedarf, Aufbewahrungssystemen, Transportmitteln und Geräten bieten wir Foodservice-Profis globale, übergreifende und vertrauenswürdige Lösungen zu bieten.

BACK OF THE HOUSE



FRONT OF THE HOUSE



MAQUINARIA / EQUIPMENT / EQUIPEMENT / KÜCHENASCHINEN





NOVEDAD / NOVELTY
NOUVEAUTÉ/ NEUHEITEN 12



COCINA / KITCHEN / CUISINE/ KÜCHE

2 BATERÍA DE COCINA / COOKWARE / BATTERIE DE CUISINE / KOCHBEDARF

2.1	INOX-PRO	38
2.2	TOP LINE	46
2.3	COOL•LINE	48
2.4	IDEA	50
2.5	DAILY	52
2.6	CENTURY	53
2.7	BLACK SERIES	56
2.8	BLACK FORGED	57



4 HORNO Y RUSTIDERAS / OVEN AND ROAST PAN / FOUR ET PLAQUES À RÔTIR / OFEN- UND BRATFORMEN

4.1	RUSTIDERAS / ROAST PANS / PLAQUES À RÔTIR / BRÄTER	82
4.2	BANDEJAS HORNO GASTRONORM / GASTRONORM SHEET PANS / PLAQUES FOUR GASTRONORME / GASTRONORM OFENBLECHE	84
4.3	BANDEJAS PASTELERÍA / PASTRY TRAYS / PLAQUES À PÂTISSERIE/ PATISSERIETABLETT	86
4.4	REJILLAS / GRIDS / GRILLES/ ROST	88
4.5	BANDEJAS ESPECIALES / SPECIAL BAKING SHEET / PLAQUE FOUR SPÉCIALE / SPEZIALBLECHE	89
4.6	BANDEJAS PARA PIZZA / PIZZA BAKING SHEETS / PLAQUES À PIZZA / PIZZABLECHE	91
4.7	ACCESORIOS HORNO / OVEN ACCESSORIES / ACCESSOIRESFOUR/ OFENACCESSORIES	92

1 HORNO DE BRASA / CHARCOAL OVENS / FOUR À BRAISE / GRILLOFEN

1.1	HORNO DE BRASA / CHARCOAL OVENS / FOUR À BRAISE/ GRILLOFEN	24
1.2	ACCESORIOS / ACCESSORIES / ACCESSOIRES/ ZUBEHÖR	26
1.3	UTENSILIOS / UTENSILS / USTENSILES / UTENSILIEN	31
1.4	MENAJE BRASA / GRILL COOKWARE / MATÉRIEL À BRAISE/ GRILLZUBEHÖR	32

3 SARTENES / FRY PANS / POÊLES / PFANNEN

3.1	ACERO INOXIDABLE / ST/STEEL / ACIERINOXYDABLE/ EDELSTAHL	64
3.2	ALUMINIO / ALUMINIUM / ALUMINIUM / ALUMINIUM	67
3.3	MULTIMETAL / MULTI-PLY / MULTI-METAL/ MULTIMETALL	71
3.4	ALUMINIO FUNDICIÓN / CAST ALUMINIUM / FONTED'ALUMINIUM / ALUMINIUMGUSS	72
3.5	ACERO / STEEL / ACIER/ ROSTFREIER STAHL	75
3.6	PAELLERA / SPANISH PAELLA PAN / PLAT À PAELLA/ PAELLAPFANNE	78

5 UTENSILIOS DE COCINA / KITCHEN UTENSILS / USTENSILES DE CUISINE / KÜCHENUTENSILIEN

5.1	UTENSILIOS DE COCINA / KITCHEN UTENSILS / USTENSILESDECUISINE/ KÜCHENUTENSILIEN	96
5.2	PROCESADORES MANUALES DE ALIMENTOS / MANUAL FOOD PROCESSORS / APPAREILSMANUELSDE TRANSFORMATION DESALIMENTS / HANDLICHEN SCHNEIDEMASCHINEN GEEIGNET FÜR	123
5.3	TABLAS DE CORTE / CUTTING BOARDS / PLANCHES À DÉCOUPER/ SCHNEIDBRETTER	138
5.4	ELEMENTOS DE MEDIDA / MEASURING UTENSILS / USTENSILES DE MESURE / MESSUTENSILIEN	141
5.5	MANOPLA / MITT / GAN/ HANDSCHUHE	145
5.6	ALFOMBRAS CAUCHO / NATURAL RUBBER MATS / TAPIS EN CAOUTCHOUC / KAUTSCHUKMATTEN	145

6 HELADERÍA Y PASTELERÍA / ICE-CREAM UTENSILS & PASTRY / USTENSILES À GLACE ET PÂTISSERIE / ZUBEHÖR FÜR EISCREME UND PATISSERIE

6.1	HELADERÍA / <i>ICE-CREAM UTENSILS /</i> <i>UTENSILES POUR GLACE /</i> <i>ZUBEHÖR FÜR EISCREME</i>	148
6.2	UTENSILIOS DE PASTELERÍA / <i>PASTRY UTENSILS /</i> <i>USTENSILES DE PÂTISSERIE /</i> <i>PÂTISSERIEZUBEHÖR</i>	150
6.3	MOLDES ANTIADHERENTES / <i>NON-STICK MOULDS /</i> <i>MOULES ANTI-ADHÉSIFS /</i> <i>ANTIHAFT BACKFORMEN</i>	163
6.4	CORTAPASTAS / PASTRY CUTTER / <i>DÉCOUPOIRS/ TEIGSCHNEIDER</i>	167
6.5	MOLDES ACERO INOXIDABLE / <i>ST/STEEL PASTRY MOULDS /</i> <i>MOULES EN ACIER INOX /</i> <i>BACKFORMEN ROSTFREIER STAHL</i>	168
6.6	MANGAS Y BOQUILLAS / <i>BAGS AND TUBES /</i> <i>POCHES ET DOUILLES /</i> <i>SPRITZBEUTEL UND TÜLLEN</i>	171
6.7	MOLDES SILICONA / SILICONE MOULDS / <i>MOULES SILICONE/ SILIKONBACKFORMEN</i>	177
6.8	MOLDES FLEXIPAN / FLEXIPAN MOULDS / <i>MOULESFLEXIPAN/ FLEXIPANBACKFORMEN</i>	182



8 TRANSPORTE DE ALIMENTOS / FOOD DELIVERY / TRANSPORT D'ALIMENTS / TRANSPORT VON LEBENSMITTELN

8.1	CAJA PPE / EPP BOX / <i>BOÎTE PPE/ EPP-BOX</i>	214
8.2	INSULATED DELIVERY BAGS	216
8.3	BANDEJAS Y RECIPIENTES / <i>TRAYS AND CONTAINERS /</i> <i>PLATEAUX ET PLATS /</i> <i>TABLETTES UND BEHÄLTER</i>	222



TRANSPORTE Y ALMACENAMIENTO / TRANSPORT AND STORAGE / TRANSPORT ET STOCKAGE / TRANSPORT UND LAGERUNG

7 CUBETAS GASTRONORM / GASTRONORM CONTAINERS / BACS GASTRONORME / GASTRONORM BEHÄLTER

7.1	INOX 18/10 / 18/10 ST/STEEL / <i>INOX 18/10 / EDELSTAHL 18/10</i>	198
7.2	COMPLEMENTOS GASTRONORM / <i>GASTRONORM ACCESSORIES /</i> <i>ACCESSOIRESGASTRONORME /</i> <i>GASTRONORM ASSESSOIRES</i>	202
7.3	CON FONDO DIFUSOR / <i>WITH SANDWICH BOTTOM /</i> <i>AVEC FOND THERMO-DIFFUSEUR /</i> <i>MIT SANDWICHBODEN</i>	203
7.4	POLICARBONATO / POLYCARBONATE / <i>POLYCARBONATE/ POLYCARBONAT</i>	204
7.5	SIN BISFENOL-A / BISPHENOL-A FREE / <i>SANSBISPHÉNOL-A/ OHNE BISFENOL-A</i>	206
7.6	POLIPROPILENO / POLYPROPYLENE / <i>POLYPROPYLÈNE/ POLYPROPYLEN</i>	208
7.7	VIOLET COLLECTION	210

9 CESTAS PARA VAJILLA / DISHWASHER RACKS / CASIERS À VAISSELLE / SPÜLMASCHINENKÖRBE

9.1	CESTAS BASE Y SUPLEMENTOS / <i>RACKS AND EXTENDERS /</i> <i>PANIERIS BASE ET RÉHAUSSE /</i> <i>BASISKÖRBE UND ERWEITERUNGEN</i>	232
9.2	COMPLEMENTOS / COMPLEMENTS / <i>COMPLÉMENTS/ ZUBEHÖR</i>	238
9.3	CESTAS PARA PLATOS / PLATE RACKS / <i>CASIERSASSIETTES/ TELLERSPÜLKÖRBE</i>	240

10 CARROS / TROLLEYS / CHARIOTS / SERVIERWAGEN

10.1	CARROS DE SERVICIO ALUMINIO / ALUMINIUM SERVING TROLLES / CHARIOTS DE SERVICE EN ALUMINIUM / SERVIERWAGEN AUS ALUMINIUM	246
10.2	CARROS DE SERVICIO ACERO INOXIDABLE / ST/STEEL SERVING TROLLEYS / CHARIOTS DE SERVICE EN ACIER INOXYDABLE / SERVIERWAGEN AUS EDELSTAHL	247
10.3	CARROS GUÍAS EN ACERO INOXIDABLE / ST/STEEL RAIL TROLLEYS / CHARIOTS À GLISSIÈRES EN ACIER INOXYDABLE / SERVIERWAGEN MIT EINSCHÜBEN AUS EDELSTAHL	251
10.4	CARROS ESPECIALES / SPECIAL TROLLEYS / CHARIOTS SPÉCIAUX / SPEZIALWAGEN	257



12 MAQUINARIA / EQUIPMENT / EQUIPEMENT / KÜCHENMASCHINEN

12.1	COCCIÓN / COOKING / COUSSION / KÜCHENMASCHINEN	284
12.2	TOSTADORAS Y GRILL DE CONTACTO / TOASTEURS & CONTACT GRILLS / TOASTER ET GRILL DE CONTACT / TOASTER - KONTACKGRILL	298
12.3	PROCESADORES DE ALIMENTOS / FOOD PROCESSORS / ROBOTS MULTIFONCTION / EBENSMITTELMASCHINE	305
12.4	MAQUINARIA MANTENEDORA DE TEMPERATURA / FOOD WARMING EQUIPMENT / APPAREILS DE MAINTEN DE TEMPEÉRATURE / WARMHALTEMASCHINEN	320
12.5	MAQUINARIA HELADERÍA / ICE-CREAM MACHINES / TURBINES À GLACE / EISMASCHINEN	338



11 ESTANTERÍAS / SHELVING / ÉTAGÈRES / REGALE

11.1	ESTANTERÍAS COMPLETAS Y ANGULARES / COMPLETE AND ANGULAR SHELVING / ÉTAGÈRES COMPLÈTES ET D'ANGLE / KOMPLLETTE ECKIGE REGALE	267
11.2	ESTANTERÍAS CON RUEDAS / SHELVING ON CASTORS / ÉTAGÈRES AVEC ROUES / REGALE MIT ROLLEN	274
11.3	BANCADAS / BENCH / BANCS / BÄNKE	274
11.4	COMPONENTES / PARTS / COMPONENTS / KOMPONENTEN	275



13 MELAMINA Y PRESENTACIÓN / MELAMINE & PRESENTATION / MÉLAMINE ET PRÉSENTATION / MELAMIN UND PRÄSENTATION

344

14

BUFFET Y ACCESORIOS / BUFFET & ACCESSORIES / BUFFET ET ACCESSOIRES / BUFFET UND ZUBEHÖR

14.1	PROTECCIÓN Y TAPAS / <i>PROTECTION AND COVERS /</i> <i>PROTECTION ET COUVERCLES /</i> <i>SCHUTZ UND DECKEL</i>	392
14.2	COOL-LINE COLLECTION	396
14.3	SUPER SHAPES CUBETAS PRESENTACIÓN BUFFET / <i>BUFFET PRESENTATION STEAM TABLE PANS /</i> <i>BACS PRÉSENTATION BUFFET /</i> <i>BUFFET PRÄSENTATION DAMPFBEHEITZEWANNEN</i>	398
14.4	MIRAMAR® COOKWARE BATERÍA DE COCINA PARA PRESENTACIÓN / <i>DISPLAY COOKWARE /</i> <i>BATTERIE DE CUISINE-PRÉSENTATION /</i> <i>PRÄSENTATIONS-KOCHGESCHIRR</i>	402
14.5	CUBIC	408
14.6	PRESENTACIÓN Y EXPOSITORES / <i>DISPLAY STANDS & DISPLAY BASKETS /</i> <i>PRÉSENTOIRS ET PRÉSENTOIRS CORBEILLES /</i> <i>PRÄSENTATIONSSTÄNDER DISPLAY-KÖRBE</i>	432
14.7	CHAFINGS Y DISPENSADORES / <i>CHAFERS & DISPENSERS /</i> <i>CHAFERS ET DISTRIBUTEURS /</i> <i>CHAFERS & SPENDER</i>	436



14.8	BOLS DOBLE PARED / <i>DOUBLE WALL BOWLS /</i> <i>BOLS DOUBLE PAROI /</i> <i>DOPELWANDIGE SCHALEN</i>	444
14.9	BANDEJAS DE SERVICIO / <i>SERVING TRAYS /</i> <i>PLATEAUX / SERVIERTABLETTS</i>	448
14.10	UTENSILIOS DE SERVICIO / <i>SERVING TOOLS /</i> <i>USTENSILES DE SERVICE BUFFET /</i> <i>SERVIERBESTECK</i>	450
14.11	SEÑALIZACIÓN / <i>SIGNS /</i> <i>SIGNALIZATION / MARKIERUNG</i>	460

15

SERVICIO DE MESA / TABLE SERVICE / ARTS DE TABLE / TAFELSERVICE

15.1	MINIATURAS / <i>MINIATURES /</i> <i>MINIATURES / MINIATUREN</i>	464
15.2	PRESENTACIÓN DE MESA / <i>TABLE PRESENTATION /</i> <i>PRÉSENTATION TABLE /</i> <i>TISCHPRÄSENTATION</i>	467
15.3	SERVICIO DE MESA / <i>TABLE SERVICE /</i> <i>SERVICEDETABLE / TISCHSERVICE</i>	484



16

BAR Y CAFETERÍA / BAR & COFFEE / BAR ET CAFÉTÉRIA / BAR UND CAFETERIA

16.1	BAR	494
16.2	TÉ Y CAFETERÍA / <i>TEA & COFFEE SERVICE /</i> <i>THÉ ET CAFÉTÉRIA / TEE- UND KAFFEESERVICE</i>	504
16.3	SERVICIO DE BEBIDAS / <i>BEVERAGE SERVICE</i> <i>SERVICE À BOISSONS /</i> <i>GETRÄNKE-SERVICE</i>	508
16.4	DISPENSADORES DE TAPAS Y VASOS / <i>LIDSAVERS AND CUPDISPENSERS /</i> <i>DISTRIBUTEUR DECOUVERCLES ET GOBELETS /</i> <i>DECKELSPENDER & BECHERSPENDER</i>	512

NEW!

NOVEDAD
NOVELTY
NOUVEAUTÉ
NEUHEITEN



P. 470 - 471



P. 467



P. 471





P. 468



P. 467



NEW!



P. 393



P. 393



P. 363



NEW!



P. 362



P. 363



P. 362

NOVEDAD / NOVELTY / NOUVEAUTÉ / NEUHEITEN

NEW!



NEW!

P. 53 - 55



NOVEDAD / NOVELTY / NOUVEAUTÉ / NEUHEITEN



P. 296 - 297



P. 486



pujadas

OVEN 90

HORNO DE BRASA /
CHARCOAL OVENS /
FOUR À BRAISE /
GRILLOFEN

1.1 **HORNO DE BRASA / CHARCOAL OVENS /**
FOUR À BRAISE/ GRILLOFEN **24**

1.2 **ACCESORIOS / ACCESSORIES / ACCESSOIRES/ZUBEHÖR** **26**

1.3 **UTENSILIOS / UTENSILS /**
USTENSILES/ UTENSILIEN **31**

1.4 **MENAJE BRASA / GRILL COOKWARE /**
MATÉRIEL À BRAISE/ GRILLZUBEHÖR **32**

Hornos de brasa Pujadas

La gama de hornos de brasa es una clara apuesta de Pujadas para estar en las últimas tendencias del exigente mercado de la hostelería. Nuestra razón de ser como fabricantes nos empuja a empezar este nuevo camino en el mundo de la brasa con una gama de hornos y barbacoas diseñadas y fabricadas para el uso profesional.

La cocina a la brasa

La cocción a brasa, de origen milenario, en una parrilla cerrada da como resultado la combinación entre tradición y modernidad en la cocina contemporánea.

La cocina con brasa es la única que consigue que el jugo de los propios alimentos impregne las brasas calientes, transformándolo en partículas aromáticas que con el humo envuelven los alimentos. Esto confiere ese característico sabor braseado a carnes, pescados, mariscos, verduras, arroces, pizzas, postres y repostería, y un largo etcétera.

Pujadas charcoal ovens

Pujadas' range of charcoal ovens is a clear bet to be among the latest trends in the demanding hospitality market. We enter as manufacturer into the world of charcoal ovens with a range of ovens and barbecues designed and manufactured for professional use.

The grilled cooking

Charcoal cooking, a thousand-year-old tradition, on a closed grill results in the combination of tradition and modernity in contemporary cuisine.

Charcoal cooking is unique in that the juice of the food itself permeates the hot coals, turning them into aromatic particles that envelop the food in smoke. This is what gives that characteristically smoky flavour to meat, fish, seafood, vegetables, rice, pizza, desserts, pastries, etc.



Fours à braise Pujadas

Pujadas mise sur la gamme de fours à braise pour prendre part aux dernières tendances du marché exigeant de l'hôtellerie. Notre raison d'être en tant que fabricant nous pousse à ouvrir cette nouvelle voie dans le monde du barbecue en proposant une gamme de fours et de barbecues conçus et fabriqués pour une utilisation professionnelle.

La cuisine à la braise

La cuisson à la braise, d'origine millénaire, à l'aide d'un grille fermé représente l'alliance de la tradition et de la modernité dans la cuisine contemporaine.

La cuisson au grill est la seule qui permet au jus de l'aliment de pénétrer les braises chaudes, ce qui le convertit en particules aromatiques qui enveloppent l'aliment de fumée. Cette saveur braisée typique va imprégner les viandes, poissons, fruits de mer, légumes, riz, pizzas, desserts et pâtisseries, et bien plus encore.

Grillöfen von Pujadas

Das Sortiment an Grillöfen ist ein klares Bekenntnis von Pujadas, in den neuesten Trends des anspruchsvollen Marktes der Hotel- und Gastronomiebranche zu sein. Unsere Aufgabe als Hersteller besteht darin, diesen neuen Weg in der Welt des Grills mit einer Reihe von Öfen und Barbecue-Geräten zu beginnen, die für den professionellen Einsatz entwickelt und hergestellt werden.

Die grillküche

Das Grillen tausendjährigen Ursprungs in einem geschlossenen Grill führt zu einer Kombination aus Tradition und Moderne in der zeitgenössischen Küche.

Die Grillküche ist die einzige, in der der Saft aus dem Essen selbst die heiße Glut durchdringt und in aromatische Partikel umwandeln kann, die das Essen mit Rauch umhüllen. Dies verleiht Fleisch, Fisch, Meeresfrüchten, Gemüse, Reis, Pizza, Desserts und Gebäck sowie vielen weiteren diesen charakteristischen Grillgeschmack.



FUNCIONAMIENTO HORNO / OVEN OPERATION FONCTIONNEMENT DU FOUR / BETRIEB DES OFENS

Explicación grafica del funcionamiento de nuestros hornos y detallando la circulación del aire en su interior.

Graphic explanation of how our ovens work and details of internal air circulation.

Illustration du fonctionnement de nos fours et précisions sur la circulation de l'air à l'intérieur.

Grafische Erklärung der Funktionsweise unserer Öfen und ausführliche Darstellung der Luftzirkulation im Inneren der Öfen.

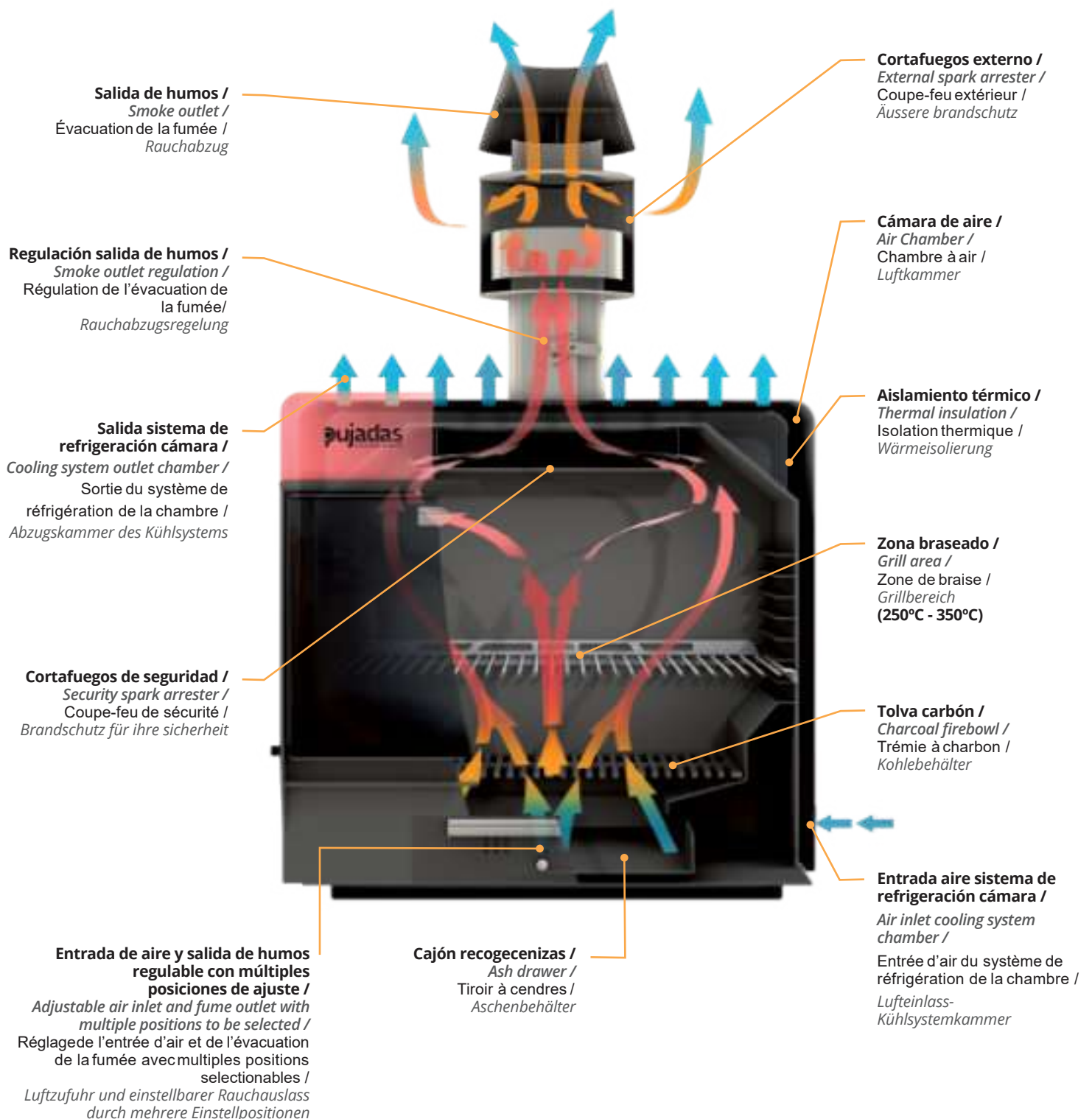

¿Qué es una parrilla cerrada?

Las parrillas cerradas nos ofrecen la posibilidad de cocinar alimentos en un espacio cerrado. Mediante el control del flujo de aire que entra en el horno podemos controlar la temperatura de cocción, así como la concentración de humo dentro del horno nos permite controlar el ahumado de los alimentos para dar un sabor muy característico.

Qu'est-ce qu'un grill fermé ?

Les grils fermés nous offrent la possibilité de cuire les aliments dans un espace clos. En contrôlant le flux d'air d'entrée dans le four, nous pouvons surveiller la température de cuisson ainsi que la concentration de fumée à l'intérieur, ce qui nous permet de maîtriser le fumage des aliments pour leur donner cette saveur si caractéristique.

What's a closed grill?

Closed grills make it possible for us to cook food in an enclosed space. By regulating the flow of air entering the oven, we can control the cooking temperature, and by regulating the amount of smoke in the oven, we can smoke the food to give it a very unique flavor.

Was ist ein geschlossener grill?

Geschlossene Grills bieten uns die Möglichkeit, Essen in einem geschlossenen Raum zu garen. Durch die Kontrolle des Luftstroms, der in den Ofen eintritt, können wir die Temperatur beim Garen steuern, ebenso wie die Konzentration des Rauchs im Inneren des Ofens uns erlaubt, das Räuchern der Speisen zu regulieren, wodurch sie einen sehr charakteristischen Geschmack erhalten.

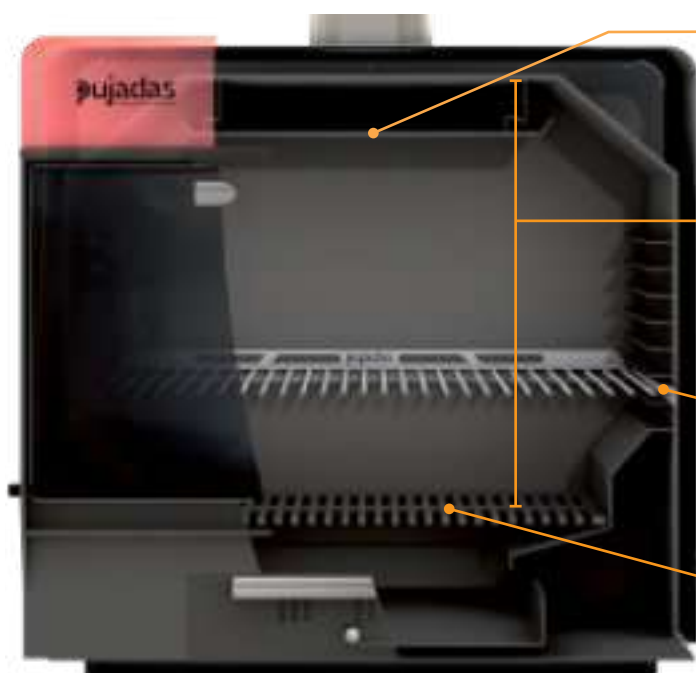

Cortafuegos de seguridad /
Security spark arrester /
Coupe-feu de sécurité /
Brandschutz für ihre Sicherheit

Cámara de braseado de mayor altura /
Higher grilling chamber /
Chambre de cuisson à la braise de plus
grande hauteur /
Höher gelegene Holzkohle-Kochkammer

Mayor número de guías para la parrilla /
Increased number of tracks for the grill /
Davantage de niveaux pour la grille /
Mehrere Schienen für das Grillrost

Tolva hundida /
Sunken charcoal hopper /
Trémie encastrée /
Unterer Behälter

- Fabricados en acero de primera calidad.
- Revestidos con materiales aislantes que optimizan el uso de carbón y reducen la radiación calorífica.
- Entrada de aire y salida de humos regulable con múltiples posiciones de ajuste.
- Cortafuegos interior para una mayor seguridad.
- Tolva hundida para aprovechar más el espacio del horno.
- Cabina interior de mayor altura, permite el uso de varias parrillas y trabajar cómodamente.
- Mayor número de guías para fijar la parrilla en varias alturas.
- 5 colores a elegir para el frontal.
- Se recomienda el uso de carbón vegetal como combustible.
- Asa de la puerta y del cajón de cenizas construido en tubo de acero inoxidable para un mejor aislamiento.
- Made of premium steel.
- Coated with insulating materials to optimize charcoal usage and reduce heat radiation.
- Adjustable air inlet and fume outlet with multiple positions to be selected.
- Internal spark arrester for added security.
- Sunken charcoal hopper to make the most of the oven space.
- Higher lid height allows for several grills and spacious cooking.
- Greater number of tracks to set the grill at various heights.
- 5 colors to choose from for the grill front.
- The use of charcoal as fuel is recommended.
- Door and ash drawer handle made of tubular stainless steel for best insulation.
- Fabriqué en acier de qualité supérieure.
- Revêtement à base de matériaux isolants pour optimiser l'utilisation du charbon et réduire les radiations thermiques.
- Réglage de l'entrée d'air et de l'évacuation de la fumée avec multiples positions sélectionnables.
- Coupe-feu intérieur pour davantage de sécurité.
- Trémie encastrée pour une utilisation optimale de l'espace du four.
- Cabine intérieure supérieure pour l'utilisation de plusieurs racks et un travail confortable.
- Plus de niveaux pour placer la grille à différentes hauteurs.
- 5 couleurs possibles pour la partie frontale.
- L'utilisation du charbon de bois comme combustible est recommandée.
- Anse de la porte et du tiroir à cendres en tube d'acier inoxydable afin de permettre un meilleur isolement thermique.
- Hergestellt aus erstklassigem Stahl.
- Beschichtet mit Isoliermaterialien, die den Einsatz von Kohle optimieren und die Wärmeabstrahlung reduzieren.
- Luftzufuhr und einstellbarer Rauchauslass durch mehrere Einstellpositionen.
- Innerer Feuerschutz für mehr Sicherheit.
- Abgesenkter Behälter zur optimalen Nutzung des Ofenraums.
- Höhere Innenkammer, die den Einsatz mehrerer Grillrost und angenehmes Arbeiten ermöglicht.
- Mehrere Schienen, um das Grillrost in verschiedenen Höhen zu verankern.
- 5 Frontfarben zur Auswahl.
- Es wird die Verwendung von Holzkohle als Brennstoff empfohlen.
- Tür- und Aschekasten griff aus Edelstahlrohr für eine bessere Isolierung.

1.1 HORNO BRASA / CHARCOAL OVENS / FOUR À BRAISE/ GRILLÖFEN

HORNOS BRASA / CHARCOAL OVENS FOUR À BRAISE/ GRILLÖFEN

OVEN50 Horno brasa / Charcoal oven / Four à braise / Grillöfen



40 - 50
comensales / diners /
couverts / gäste



Cada horno se entrega con:

- 1 parrilla de acero inoxidable
- 1 pinzas
- 1 pala recoge cenizas
- 1 atizador de carbón
- 1 cepillo de metálico para limpiar la parrilla

Chaque four est livré avec:





- 1 grille en acier inoxydable
- 1 pince
- 1 pelle pour ramasser les cendres
- 1 tisonnier à charbon
- 1 brosse métallique pour nettoyer le grill.

Each oven comes with:

- 1 stainless steel grille
- 1 tongs
- 1 ash shovel
- 1 charcoal poker
- 1 metal brush to clean the grill

Jeder Ofen wird mit geliefert:

- 1 Edelstahl-Grillrost
- 1 Zange (Pinzette)
- 1 Ascheschaufel
- 1 Schürhaken für Kohle
- 1 Metallbürste zur Reinigung des Grills

REF	Dimensiones / Dimensions / Dimensions / Maße mm Al. x An. x Pr. (H x W x D)	Parrilla / Grill / Gril / Grillrost mm	Produc. Kg/h	Temp. rec. cocción / Temp. Rec. Cooking / Temp. réch. cuisson / Empf. Temp. Garen °C	Pot. Equiv. / Power Equiv. / Puiss. Équiv. / Leist. Äquiv. KW	Consumo / Consum. / Consum. / Verbrauch Kg/ day / day / jour / Tag	Carga carbón / Chacoal load / Charge de charbon / Kohleladung kg	Peso / Weight / Poids / Gewicht kg	Color / Colour / Couleur / Farbe	
P850.50R										
P850.50B	620x700x555	585x385	30	250-350	4	10-12	5	130		1
P850.50SS										

OVEN90 Horno brasa / Charcoal oven / Four à braise / Grillöfen



80 - 90
comensales / diners /
couverts / gäste



Cada horno se entrega con:

- 1 parrilla de acero inoxidable
- 1 pinzas
- 1 pala recoge cenizas
- 1 atizador de carbón
- 1 cepillo de metálico para limpiar la parrilla

Chaque four est livré avec:





- 1 grille en acier inoxydable
- 1 pince
- 1 pelle pour ramasser les cendres
- 1 tisonnier à charbon
- 1 brosse métallique pour nettoyer le grill.

Each oven comes with:

- 1 stainless steel grille
- 1 tongs
- 1 ash shovel
- 1 charcoal poker
- 1 metal brush to clean the grill

Jeder Ofen wird mit geliefert:

- 1 Edelstahl-Grillrost
- 1 Zange (Pinzette)
- 1 Ascheschaufel
- 1 Schürhaken für Kohle
- 1 Metallbürste zur Reinigung des Grills

REF	Dimensiones / Dimensions / Dimensions / Maße mm Al. x An. x Pr. (H x W x D)	Parrilla / Grill / Gril / Grillrost mm	Produc. Kg/h	Temp. rec. cocción / Temp. Rec. Cooking / Temp. réch. cuisson / Empf. Temp. Garen °C	Pot. Equiv. / Power Equiv. / Puiss. Équiv. / Leist. Äquiv. KW	Consumo / Consum. / Consum. / Verbrauch Kg/ day / day / jour / Tag	Carga carbón / Chacoal load / Charge de charbon / Kohleladung kg	Peso / Weight / Poids / Gewicht kg	Color / Colour / Couleur / Farbe	
P850.90R										
P850.90B	720x700x655	585x485	70	250-350	5,5	14-16	7	145		1
P850.90SS										

HORNO BRASA / CHARCOAL OVENS /
FOUR À BRAISE/ GRILLÖFEN

OVEN140 Horno brasa / Charcoal oven / Four à braise / Grillöfen



130-140
comensales / diners /
couverts / gäste



Cada horno se entrega con:

- 1 parrilla de acero inoxidable
- 1 pinzas
- 1 pala recoge cenizas
- 1 atizador de carbón
- 1 cepillo de metálico para limpiar la parrilla

Each oven comes with:

- 1 stainless steel grille
- 1 tongs
- 1 ash shovel
- 1 charcoal poker
- 1 metal brush to clean the grill

Chaque four est livré avec:

- 1 grille en acier inoxydable
- 1 pince
- 1 pelle pour ramasser les cendres
- 1 tisonnier à charbon
- 1 brosse métallique pour nettoyer le grill.

Jeder Ofen wird mit geliefert:

- 1 Edelstahl-Grillrost
- 1 Zange (Pinzette)
- 1 Ascheschaufel
- 1 Schürhaken für Kohle
- 1 Metallbürste zur Reinigung des Grills



REF	Dimensiones / Dimensions / Dimensions / Maße mm Al. x An. x Pr. (H x W x D)	Parrilla / Grill / Gril / Grillrost mm	Produc. Kg/h	Temp. rec. cocción / Temp. Rec. Cooking / Temp. réch. cuisson / Empf. Temp. Garen °C	Pot. Equiv. / Power Equiv. / Puiss. Équiv. / Leist. Äquiv. KW	Consumo / Consum. / Consum. / Verbrauch Kg/ day / day / jour / Tag	Carga carbón / Charcoal load / Charge de charbon / Kohleladung kg	Peso / Weight / Poids / Gewicht kg	Color / Colour / Couleur / Farbe	
P851.40R										
P851.40B	880x900x840	775x655	100	250-350	6,5	16-18	9	235		1
P851.40SS										

P850000 Carbón vegetal calidad hosteleria / Premium grade charcoal /
Charbon de bois qualité restaurant / Restaurant Qualität Grill-Holz Kohle

Unidad de venta:
1 palet de 30 sacos de 10Kg. de carbón

Sale unit:
1 pallet including 30 10Kg charcoal bags

Unité de vente:
1 palette 30 sacs de 10Kg. de charbon de bois

Verkaufseinheit:
1 palette 30 x 10Kg. grill-holz kohle sack



REF	Tipo de madera / Wood type / Type de bois / Holzart	Poder calorífico / Calorific value / Puissance calorifique / Heizwert Kcal/Kg	Granulometría / Granulometry / Granulométrie / Granulometrie mm	Carbono / Carbon / Carbone / Kohlenstoff %	Cenizas / Ashes / Cendres / Asche %	Humedad / Humidity / Humidité / Feuchtigkeit %	Densidad / Density / Densité / Dichte Km/m³	Peso saco / Bag weight / Poids sac / Sackgewicht Kg
P850000	Marabú	≈ 8000	150	> 75	< 5	< 6	298	10



P8505012 Bandejas sistema modular para Oven 50 / Modular tray system for Oven 50 /
Plateaux de système modulaire pour Oven 50 / Modulare Systemwannen für Oven 50

NEW!

REF	Unidades / Units / Unités / Einheiten	H mm	
P850501215	2	15	1
P850501230	2	30	1
P850501315	3	15	1
P850501330	3	30	1
P850502815	4	15	1
P850502830	4	30	1



P850501215
P850501230



P850501315
P850501330



P850502815
P850502830

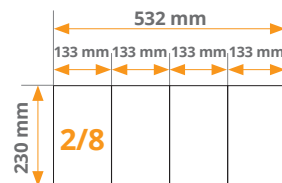
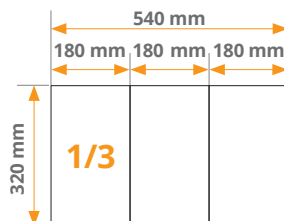
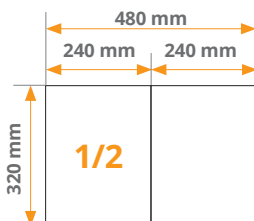

P8509014 Bandejas sistema modular para Oven 90 / Modular tray system for Oven 90 /
Plateaux de système modulaire pour Oven 90 / Modulare Systemwannen für Oven 90



P850901415
P850901430



P850901615
P850901630



P850901815
P850901830

REF	Unidades / Units / Unités / Einheiten	H mm	
P850901415	4	15	1
P850901430	4	30	1
P850901615	6	15	1
P850901630	6	30	1
P850901815	8	15	1
P850901830	8	30	1

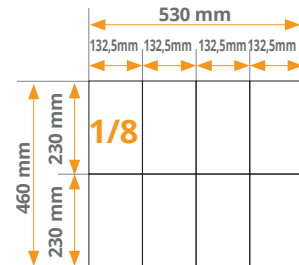
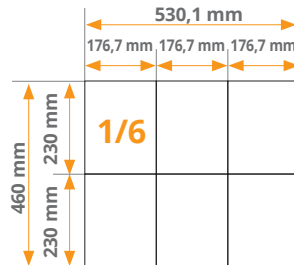
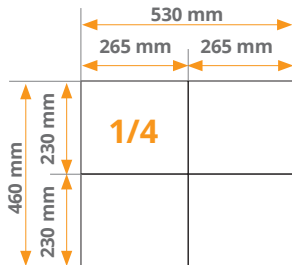

P8514014 Bandejas sistema modular para Oven 140 / Modular tray system for Oven 140 /
Plateaux de système modulaire pour Oven 140 / Modulare Systemwannen für Oven 140



P851401415
P851401430



P851401615
P851401630



P851401815
P851401830

REF	Unidades / Units / Unités / Einheiten	H mm	
P851401415	4	15	1
P851401430	4	30	1
P851401615	6	15	1
P851401630	6	30	1
P851401815	8	15	1
P851401830	8	30	1

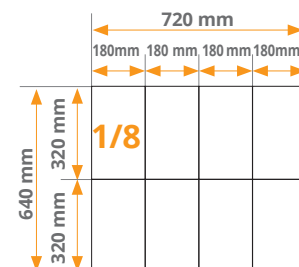
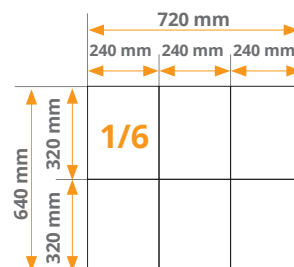
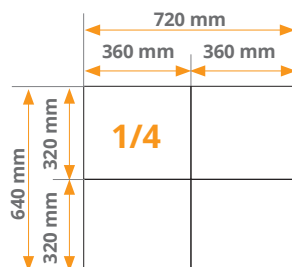

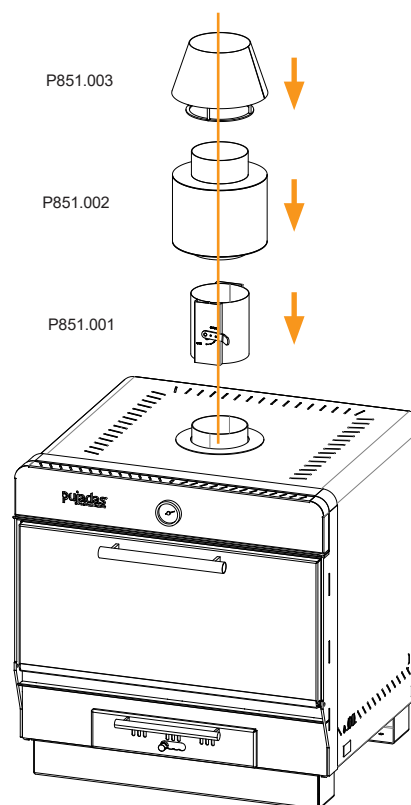

P851003 Filtro sombrero / Hat filter /
Filtre chapeau supérieur / Zylinder-Filter



REF	
P851.003	1

P851002 Cortafuegos externo / External cutter flame /
Coupe-feu externe / Äußerer Feuerschutz



REF	
P851.002	1

P851001 Regulador de tiro superior / Upper air flow regulator /
Régulateur de sortie de fumée / Obere Dämpfungselemente



REF	
P851.001	1

RE8505004 Parrilla varilla inox horno / Stainless steel oven rack /
Grille en acier inoxydable / Grillrost aus rostfreiem Stahl

REF	Horno / Oven / Four / Grillöfen	mm	
RE850.5004	50	585x385	1
RE850.9007	90	585x485	1
RE851.4007	140	775x655	1



RE851.4007



RE850.9007



RE850.5004

NEW!

P85090SP

Soporte pinchos para Oven 90 /
Skewer rack for Oven 90 /
Supports de brochettes pour Oven 90 /
Spießhalterung für Oven 90

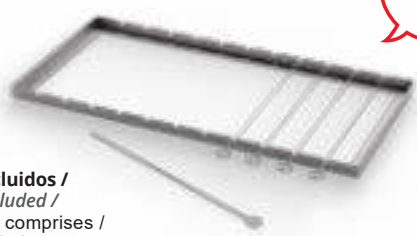

Pinchos no incluidos /
Skewers not included /
Brochettes non comprises /
Spieße nicht enthalten /

REF	Horno / Oven / Four / Grillöfen	mm	
P85090SP	90	585x285x20	1

NEW!

P85140SP

Soporte pinchos para Oven 140 /
Skewer rack for Oven 140 /
Supports de brochettes pour Oven 140 /
Spießhalterung für Oven 140

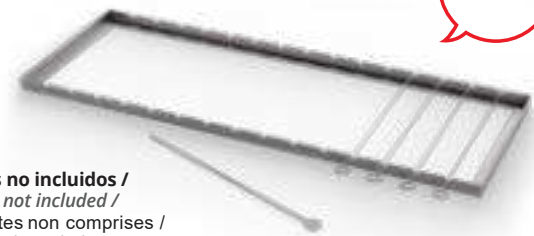

Pinchos no incluidos /
Skewers not included /
Brochettes non comprises /
Spieße nicht enthalten /

REF	Horno / Oven / Four / Grillöfen	mm	
P85140SP	140	775x285x20	1

NEW!

P968 Porta pinchos / Carry-skewers /
Porte-brochettes / Spiesshalter



REF	Ø cm	H cm	
P968.000	22	46	1

P9681 Pincho / Skewer /
Brochette / Spiess



Compatible con soporte pinchos P85090SP y P85140SP / Compatible with
skewer racks P85090SP and P85140SP /
Compatible avec les supports de brochettes P85090SP et P85140SP /
Kompatibel mit Spießhalterung P85090SP und P85140SP /

REF	L cm	
P968.135	35	12

P85090 Mesa para horno Oven 90 / Oven table - Oven 90 /
Table pour four Oven 90 / Tisch für Ofen - Oven 90



P850.90MP



P850.90MT

REF	con ruedas w/wheels avecroues mit Rädern	mm		📦
		Al. x An. x Pr.		
P850.90MT	×	900 x 670	x 550	1
P850.90MP	×	950 x 680	x 550	1
P850.90MTR	✓	850 x 670	x 550	1
P850.90MPR	✓	900 x 680	x 550	1



Disponibile con ruedas
Available with wheels
Disponibile avecroues
Erhältlich mit Rädern

P85140 Mesa para horno Oven 140 / Oven table - Oven 140 /
Table pour four Oven 140 / Tisch für Ofen - Oven 140



P851.40MP



P851.40MT

REF	con ruedas w/wheels avecroues mit Rädern	mm		📦
		Al. x An. x Pr.		
P851.40MT	×	770 x 870	x 735	1
P851.40MP	×	820 x 880	x 735	1
P851.40MTR	✓	820 x 870	x 735	1
P851.40MPR	✓	770 x 880	x 735	1



Disponibile con ruedas
Available with wheels
Disponibile avecroues
Erhältlich mit Rädern

Pinza reforzada horno /
Heavy duty oven tong /
Pincerenforcée pour four /
Verstärkte Zange für Öfen

P851004

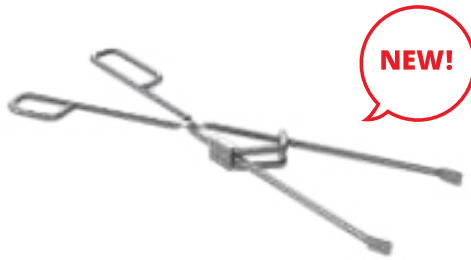

REF	cm	
P851.004	33,5	1

Pala atizadora horno brasa /
Oven poker /
Tisonnier pour four à braise /
Schürhaken für Holzkohlegrillöfen

P851005



REF	cm	
P851.005	64,5	1

478 Pinza de acero inoxidable / Stainless steel tong /
Pince inoxydable / Edelstahl-Servierzange

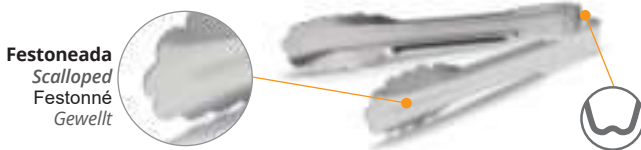

REF	L cm	
4781210	30,5	12
4781610	40,6	12

479 Pinza VERSAGRIP® de acero inoxidable /
VERSAGRIP® Stainless steel tong /
Pince inox VERSAGRIP® /
VERSAGRIP® Edelstahl-Servierzange



REF	L cm	
4791210	30,5	12
4791610	40,6	12

P851006 Pala recogecenizas / Collect ashes shovel /
Pelle à cendres / Ascheschaufel



REF	Al. x An. x Pr. cm	
P851.006	13 x 14,5 x 38,5	1

P851007 Cepillo metálico / Metallic brush /
Brosse métallique / Metallbürste



REF	L cm	
P851.007	23,5	1
RE851.008	23,5	1

Ver productos en / See products on /
Voir produits en page / Siehe produkte in

P.
56

BLACK SERIES



Ver productos en / See products on / Voir produits en page / Siehe produkte in

P.
72

BLACK PRO



Ver productos en / See products on /
Voir produits en page / Siehe produkte in

P.
75

STEEL PRO 1921 SERIES



Ver productos en / See products on /
Voir produits en page / Siehe produkte in

P.
77

STEEL CLASSIC



Ver productos en / See products on / Voir produits en page / Siehe produkte in

P.
78

PAELLERA Y SARTÉN HONDA



Ver productos en / See products on /
Voir produits en page / Siehe produkte in

P.
82

P.
89

RUSTIDERA / ROAST PAN / PLAQUE À RÔTIR / BRÄTER



Ver productos en / See products on /
Voir produits en page / Siehe produkte in

P.
468

LLAUNAS PRESENTACIÓN / TIN PLATES DISPLAY / PLATEAUX INOX PRÉSENTATION / PRÄSENTATIONSTABLETTES



Ver productos en / See products on / Voir produits en page / Siehe produkte in

P.
464

MINIATURAS HIERRO FUNDIDO / CAST IRON MINIATURES / MINIATURES FONTE ÉMAILLÉE / MINIATUREN GUSSEISEN





2.1 **INOX-PRO** **38**

2.2 **TOP LINE** **46**

2.3 **COOL•LINE** **48**

2.4 **IDEA** **50**

2.5 **DAILY** **52**

2.6 **CENTURY** **53**

2.7 **BLACK SERIES** **56**

2.8 **BLACK FORGED** **57**

**PROFESIONAL / PROFESSIONAL /
 PROFESSIONNEL / PROFESSIONELL**

**ACERO INOXIDABLE /
 STAINLESS STEEL /
 ACIER INOX /
 ROSTFREIER STAHL**

	INOX-PRO	TOP LINE	COOL • LINE	IDEA
REF / ITEM / CODE / ART.NR.	 BEST SELLER P. 38	 P. 46	 P. 48	 P. 50
COMPATIBLE CON / COMPATIBLE WITH / COMPATIBLE AVEC / GEEIGNET FÜR	 INDUCTION induction gas vitro electric	 INDUCTION induction gas vitro electric	 INDUCTION induction gas vitro electric	 INDUCTION induction gas vitro electric
PRECIO / PRICE / PRIX / PREIS				
GARANTÍA AÑOS / WARRANTY YEARS / GARANTIE ANNÉES / GARANTIE JAHRE	5	5	4	3
CERTIFICACIÓN / CERTIFICATION / CERTIFICATION / ZERTIFIKATION				
ASAS / HANDLES / ANSES / GRIFFE	VARILLA / WIRE / FILS / DRAHT	 AISLANTES / INSULATION / ISOLANTES / ISOLIERUNG	FUNDICIÓN / CAST / FONTE / GUSSEISEN	DISEÑO / DESIGN / DESIGN / DESIGN
RESTAURANTE / RESTAURANT / RESTAURANT / RESTAURANT	TODO TIPO / ANY KIND / TOUST YPOS / ALLE TYPEN	GASTRONÓMICO / GASTRONOMIC / GASTRONOMIQUE / GASTRONOMIE	GOURMET	MODERNA / MODERN / MODERNE / MODERN
MEDIDAS Ø / MEASURES Ø / MESURES Ø / MASSE Ø	12-60	12-60	16-32	12-32

ALUMINIO /
ALUMINIUM /
ALUMINIUM /
ALUMINIUM

DAILY

CENTURY

BLACK SERIES

BLACK FORGED



 **INDUCTION**

 **NO INDUCTION**

 **NO INDUCTION**

 **INDUCTION**



1

1

2

2



TUBULAR /
TUBULAR /
TUBULAIRE /
TUBULÁR

TUBULAR /
TUBULAR /
TUBULAIRE /
TUBULÁR

INTEGRADO /
INTEGRATED /
INTÉGRÉ /
INTEGRIERT

INTEGRADO /
INTEGRATED /
INTÉGRÉ /
INTEGRIERT

TRADICIONAL /
TRADITIONAL /
TRADITIONNEL /
TRADITIONELL

TRADICIONAL /
TRADITIONAL /
TRADITIONNEL /
TRADITIONELL

TRADICIONAL Y PRESENTACIÓN /
TRADITIONAL AND PRESENTATION /
TRADITIONNEL ET PRESENTATION /
TRADITIONELL UND PRÄSENTATION

TRADICIONAL /
TRADITIONAL /
TRADITIONNEL /
TRADITIONELL

14-28

16-60

16-40

16-28

INOX-PRO



 **INDUCTION**



**Eficacia / Efficacy /
Efficacité / Effizienz**



**frío / cold /
froid / kälte** **caliente / warm /
chaud / hitze**

Diseñada para ofrecer el mayor rendimiento en la cocina profesional /
Specially designed to achieve the best performance in the professional cooking /
Conçue pour offrir le plus haut rendement dans la cuisine professionnelle /
Spezielles Design für die Beste Performanz in der Professionellen Küche

Cuerpo en acero inoxidable 18/10 /
Cookware body made of 18/10 stainless steel /
Corps en acier inoxydable 18/10 /
Kochkörper aus Edelstahl 18/10

Segura: asas soldadas por aportación de materiales /
Safety : welded handles by build-up process /
Sécurité : soudures des anses par résistance /
Sicherheit: angeschweisste griffe für die resistenz



**Solida y robusta: asas de varillas
matizada en inox ultraresistentes,
500 kg /**

*Solid and robust: st/steel wire handle
ultra-resistant, 500kg /*

*Solide et robuste : anses en fil inox
ultra-résistantes, 500kg /*

*Solide und robust: griffe aus
edelstahldraht, ultra resistant, 500kg*



Eficiente: tapas diseñadas para el ahorro de energía /
Efficient: lids designed to save energy /
Efficient : couvercles conçus pour économiser de l'énergie /
Effizient: energiesparendes deckeldesign

Única: identificación de origen y tipo fuente de calor /
Unique: origin identification and type of cooking system /
Unique : identification de l'origine et type de système de cuisson /
Unikat: herkunftsidentifizierung und typ des kochsystems



Garantía: control de todos los procesos de fabricación /
Warranty: control of all production processes /
Garantie : contrôle de tous les processus de production /
Garantie: kontrolle aller fabrikationsprozesse

Calidad: pulido satinado interior y exterior uniforme en todos los modelos /

Quality: inner and outer sides of all models with uniform satin polishing /

Qualité : polissagesatiné uniforme à l'intérieur et l'extérieur de tous les modèles /

Qualität: satinierte polierung innen und aussen einheitlich für alle modelle

Radios interiores diseñados para una limpieza fácil y rápida /
Radius specially designed for easy and fast cleaning /
Rayonspermettant un entretien facile et rapide /
Innen-radius designt für einfache und schnelle reinigung



Inducción: fondo sandwich técnico (inox - alu - inox) /

Induction: technical sandwich base (stainless steel - aluminium - stainless steel) /

Induction : fond sandwich technique inox - alu - inox) /

Induktion: tech-sandwichboden (inox - alu - inox)

Control: soldadura artesanal e inspección en cada unidad /
Control: handcrafted welding and checking every unit /
Contrôle : soudure artisanale et verification de chaque unité /
Kontrolle: handangeschweisst und überprüfung jeder einheit

Las baterias de cocina se venden sin tapa.

The cookware sold without lids.

Les batteries de cuisine sont-elles vendues sans couvercle.

Das Kochgeschirr wird ohne Deckel verkauft.

P218 Olla recta sin tapa / Stockpot without lid / Marmite traiteur sans couvercle / Hoher Kochtopf ohne Deckel

CLASS
INDUCTION



REF	Ø cm	H cm	Lts	
P218.016	16	16,0	3,00	1
P218.018	18	18,0	4,50	1
P218.020	20	20,0	6,20	1
P218.024	24	24,0	10,00	1
P218.028	28	28,0	16,50	1
P218.030	30	30,0	21,20	1
P218.032	32	32,0	24,00	1
P218.035	35	35,0	33,60	1
P218.040	40	40,0	50,00	1
P218.045	45	45,0	72,00	1
P218.050	50	50,0	98,00	1
P218.060	60	55,0	155,00	1

P217 Cacerola baja sin tapa / Casserole without lid / Faitout sans couvercle / Flache Kasserolle ohne Deckel

CLASS
INDUCTION



REF	Ø cm	H cm	Lts	
P217.016	16	7,5	1,50	1
P217.018	18	8,0	2,00	1
P217.020	20	8,0	2,50	1
P217.024	24	9,50	4,30	1
P217.028	28	11,0	6,70	1
P217.030	30	12,0	8,40	1
P217.032	32	12,5	10,00	1
P217.035	35	14,0	13,60	1
P217.040	40	15,5	19,50	1
P217.045	45	17,0	27,00	1
P217.050	50	20,0	39,00	1
P217.060	60	23,0	65,00	1

P216 Cacerola alta sin tapa / Sauce pot without lid / Braisière sans couvercle / Hohe Kasserolle ohne Deckel

CLASS
INDUCTION



REF	Ø cm	H cm	Lts	
P216.016	16	11,0	2,10	1
P216.018	18	12,0	3,00	1
P216.020	20	13,0	4,00	1
P216.024	24	14,0	6,30	1
P216.028	28	17,5	10,20	1
P216.030	30	18,0	12,70	1
P216.032	32	19,0	15,20	1
P216.035	35	21,0	20,20	1
P216.040	40	25,0	31,40	1
P216.045	45	28,0	44,50	1
P216.050	50	30,0	59,00	1
P216.060	60	35,0	99,00	1

P205 Paellera sin tapa / Paella pan without lid / Plat à paella sans couvercle / Paellapfanne ohne Deckel

CLASS
INDUCTION



REF	Ø cm	H cm	Lts	
P205.020	20	6,0	1,90	1
P205.024	24	6,0	2,70	1
P205.028	28	6,0	3,70	1
P205.030	30	6,0	4,30	1
P205.032	32	6,0	4,70	1
P205.035	35	7,0	6,70	1
P205.040	40	8,0	10,00	1
P205.045	45	8,5	12,00	1
P205.050	50	9,0	17,50	1
P205.060	60	10,0	28,00	1

P209 Tapa / Lid / Couvercle / Deckel



REF	Ø cm		
P209.016	16	1	
P209.018	18	1	
P209.020	20	1	
P209.024	24	1	
P209.028	28	1	
P209.030	30	1	
P209.032	32	1	
P209.035	35	1	
P209.040	40	1	
P209.045	45	1	
P209.050	50	1	
P209.060	60	1	

P201 Cazo recto bajo / Saucepan /
Casserole / Stielkasserolle

CLASS
INDUCTION



REF	Ø cm	H cm	Lts	
P201.016	16	7,5	1,50	1
P201.018	18	8,0	2,00	1
P201.020	20	8,0	2,50	1
P201.024	24	9,5	4,30	1
P201.028	28	11,0	6,70	1
P201.032	32*	12,50	10,00	1

* Con contraasa / With counterhandle / Avec contre anse / Mit Zusatzgriff

P202 Cazo recto alto / Deep saucepan /
Casserole haute / Hohe Stielkasserolle

CLASS
INDUCTION



REF	Ø cm	H cm	Lts	
P202.016	16	11,0	2,10	1
P202.018	18	12,0	3,00	1
P202.020	20	13,0	4,00	1
P202.024	24	14,0	6,30	1
P202.028	28	17,5	10,20	1
P202.032	32*	19,0	15,20	1

* Con contraasa / With counterhandle / Avec contre anse / Mit Zusatzgriff

P200 Cazo tipo francés /
French style saucepan /
Casseroleforme française /
Französische Kasserolle

CLASS
INDUCTION



REF	Ø cm	H cm	Lts	
P200.012	12	7,0	0,70	1
P200.014	14	7,0	1,00	1
P200.016	16	7,5	1,50	1
P200.018	18	9,0	2,30	1
P200.020	20	10,0	3,10	1
P200.022	22	11,0	4,20	1
P200.024	24	12,0	5,40	1
P200.028	28	14,0	8,60	1

P2001 Cazo con picos laterales /
Saucepan with side spouts /
Casserole avec becs verseurs /
Stielkasserolle mit Ausgüssen

CLASS
INDUCTION



REF	Ø cm	H cm	Lts	
P200.116	16	7,5	1,50	1
P200.120	20	10,0	3,10	1

P214 Cazo cónico /
Conical sauté pan /
Sauteuse evasée /
Konische Stielkasserolle

CLASS
INDUCTION



REF	Ø cm	H cm	Lts	
P214.016	16	6,0	1,00	1
P214.018	18	6,0	1,20	1
P214.020	20	6,5	1,60	1
P214.022	22	7,0	2,10	1
P214.024	24	7,5	2,70	1

P2003 Cazo bombeado / Rounded saucepan / Casserole bombée / Kugelige Stielkasserolle mit Schüttrand

CLASS
INDUCTION



REF	Ø cm	H cm	Lts	
P200.320	20	7,5	1,80	1
P200.324	24	8,5	3,00	1

Con fondo termodifusor tipo sandwich
With diffusing bottom sandwich type
Avecfond thermo diffuseur type sandwich
Mit Thermodiffusionsboden Typ Sandwich

P203 Baño maría / Bain marie / Bain-marie / Wasserbad

CLASS
INDUCTION



REF	Ø cm	H cm	Lts	
P203.016	16	16,0	3,00	1
P203.018	18	18,0	4,50	1
P203.020	20	20,0	6,20	1
P203.024	24	24,0	10,00	1

Con fondo termodifusor tipo sandwich
With diffusing bottom sandwich type
Avecfond thermo diffuseur type sandwich
Mit Thermodiffusionsboden Typ Sandwich

P204 Sautex / Sauté pan / Sauteuse / Sauteuse

CLASS
INDUCTION



REF	Ø cm	H cm	Lts	
P204.020	20	6,0	1,90	1
P204.024	24	6,0	2,70	1
P204.028	28	6,0	3,70	1
P204.030	30	6,0	4,30	1
P204.032	32	6,0	4,70	1
P204.035	35	7,0	6,70	1
P204.040*	40	8,0	10,00	1

* Con contraasa / With counterhandle / Avec contre anse / Mit Zusatzgriff

MULTIMETAL

P234 Cazo bombeado / Rounded saucepan / Casserole bombée / Kugelige Stielkasserolle mit Schüttrand



NSF

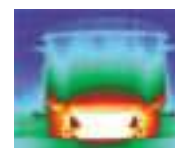

Inox - st/steel
Rostfreier stahl

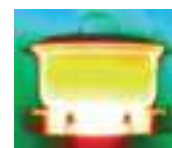

Multimetal

REF	Ø cm	H cm	Lts	
P234.020	20	7,5	1,80	1
P234.024	24	8,5	3,00	1

Conjunto cuscusera bombeada, con tapa /
Conical couscous set with lid /
Conjoussier bombée avec couvercle /
Konisches Couscoustopfset mit Deckel

P240

CLASS
INDUCTION



REF	Ø cm	H cm	Lts		
P240.040	A	40	20,0	20,00	1
	B	32	32,0	24,00	
P240.050	A	50	25,0	40,00	1
	B	40	40,0	50,00	

Conjunto cuscusera forma recta /
Straight couscous set /
Couscoussierforme droite /
Couscoustopfset gerade Form

P242

CLASS
INDUCTION



REF	Ø cm	H cm	Lts		
P242.024	A	24	14,0	6,30	1
	B	24	24,0	10,00	
P242.028	A	28	17,5	10,00	1
	B	28	28,0	16,50	
P242.032	A	32	19,0	15,00	1
	B	32	32,0	24,00	
P242.035	A	35	21,0	20,00	1
	B	35	35,0	33,60	

Con tapa / With lid / Avec couvercle / Mit Deckel

P241

Parte superior de cuscusera bombeada /
Top for couscous set conical shape /
Dessusseul pour couscoussier forme bombée /
Oberteil vom konischen Couscoustopfset



REF	Ø cm	H cm	Lts	
P241.040	40	20,0	20,00	1
P241.050	50	25,0	40,00	1

Ø agujeros / holes / trous / Löcher 4 mm
Sin tapa / Without lid / Sans couvercle / Ohne Deckel

P243

Parte superior de vaporera y cuscusera /
Top for steam pot and couscous set straight shape /
Dessusseul pour couscoussierforme droite et cuit vapeur /
Oberteil Dampfgarer und Couscoustopf



REF	Ø cm	H cm	Lts	
P243.024	24	14,0	6,30	1
P243.028	28	17,5	10,00	1
P243.032	32	19,0	15,00	1
P243.035	35	21,0	20,00	1

Ø agujeros / holes / trous / Löcher 4 mm
Sin tapa / Without lid / Sans couvercle / Ohne Deckel

P244 Conjunto vaporera / Steam pot /
Cuit vapeur / Dampfgarset

CLASS
INDUCTION



REF	Ø cm	H cm	Lts		
P244.020	A	20	13,0	4,00	1
	B	20	13,0	4,00	
P244.024	A	24	14,0	6,30	1
	B	24	14,0	6,30	
P244.028	A	28	17,5	10,00	1
	B	28	17,5	10,00	
P244.032	A	32	19,0	15,00	1
	B	32	19,0	15,00	
P244.035	A	35	21,0	20,00	1
	B	35	21,0	20,00	

Con tapa / With lid / Avec couvercle / Mit Deckel

P224 Colapasta / Pasta colander /
Cuit-pâtes / Nudelsieb



REF	H cm		
P224.023	A	23,0	1
P224.026	B	26,0	1

A Utilizable para la ref. 216 - Ø 35 cm
A It fits ref. 216 - Ø 35 cm
A Utilisable pour la ref. 216 - Ø 35 cm
A Benutzbar für Art.Nr. 216 - Ø 35 cm

B Utilizable para la ref. 216 - Ø 40 cm
B It fits ref. 216 - Ø 40 cm
B Utilisable pour la ref. 216 - Ø 40 cm
B Benutzbar für Art.Nr. 216 - Ø 40 cm

P223 Conjunto cacerola + 4 colapastas /
Casserole set + 4 pasta colander /
Ensemble braisière + 4 cuit-pâtes /
Kasserolleset + 4 Nudelsiebe

CLASS
INDUCTION



REF	Ø cm	H cm	Lts	
P223.035	35	21,0	20,20	1
P223.040	40	25,0	31,40	1

Datos relativos a la cacerola 216.

Casserole data 216.

Caractéristiques afférentes au braisière 216.

Entsprechende Eigenschaften der Kasserolle 216.

Sin tapa / Without lid / Sans couvercle / Ohne Deckel

P248 Olla con grifo y tapa /
Stock pot with tap and lid /
Marmite traiteur avec robinet et couvercle /
Topf mit Ablaufahn und Deckel

CLASS
INDUCTION



REF	Ø cm	H cm	Lts	
P248.028	28	28,0	16,50	1
P248.032	32	32,0	24,00	1
P248.035	35	35,0	33,60	1
P248.040	40	40,0	50,00	1
P248.045	45	45,0	72,00	1





INDUCTION



Eficacia / Efficacy /
Efficacité / Effizienz



frio / cold /
froid / kälte

caliente / warm /
chaud / hitze

Eficiencia / Efficacy /
Efficacité / Effizienz



acero / aluminio / aluminium
inox-st/steel / edelstahl / aluminium

La batería más exclusiva para la alta cocina /
The most exclusive cookware lead to high cuisine /
La plus exclusive batterie pour la haute cuisine /
Exklusivster Kochbedarf für die Gehobene Küche

Cuerpo en acero inoxidable 18/10 /
Cookware body made of 18/10 stainless steel /
Corps en acier inoxydable 18/10 /
Kochbedarf aus Edelstahl 18/10

Facilidad: etiquetas identificativas de fácil extracción /
Easy: identification sticker easy to remove /
Facile: étiquettes identificatrices faciles à enlever /
Einfach: identifizierungsetiketten leicht zu entfernen

Efficiente: tapas diseñadas para el ahorro de energía /
Efficient: lids designed to save energy /
Efficient : couvercles conçus pour économiser de l'énergie /
Effizienz: energiesparendes deckeldesign

Vertido fácil /
Easy pouring /
Vercement facile /
Schüttrand

Aislante: asas de inox resistentes al calor /
Insulating: st/steel heat resistant handles /
Isolant : anses en acier inoxydable résistantes à la chaleur /
Isolierung: hitzebeständige griffe aus edelstahl

Estética: acabado satinado /
Aesthetics: satin finish /
Esthétique : finition satinée /
Ästhetik: satinierte ausführung

Calidad: satinado uniforme en todos los modelos /
Quality: uniform satin polishing in all models /
Qualité : polissage satiné uniforme sur tous les modèles /
Qualität: einheitlich matt glänzend für alle modelle

Control: soldadura artesanal e inspección en cada unidad /
Control: handcrafted welding and checking every unit /
Contrôle: soudure artisanale et vérification de chaque unité /
Kontrolle: handangeschweisst und überprüfung jeder einheit

Inducción: fondo sandwich técnico (inox - alu - inox) /
Induction: technical sandwich base (stainless steel - aluminium - stainless steel) /
Induction : fond sandwich technique (inox - alu - inox) /
Induktion: tech-sandwichboden (inox - alu - inox)

P2901 Olla recta sin tapa / *Stock pot without lid* / Marmite traiteur sans couvercle / *Hoher Kochtopf ohne Deckel*

CLASS
INDUCTION



REF	Ø cm	H cm	Lts	
P290.120	20	20,0	6,20	1
P290.124	24	24,0	10,00	1
P290.128	28	28,0	16,50	1
P290.130	30	30,0	21,20	1
P290.132	32	32,0	24,00	1
P290.135	35	35,0	33,60	1
P290.140	40	40,0	50,00	1
P290.145	45	45,0	72,00	1
P290.150	50	50,0	98,00	1

P2911 Cacerola baja sin tapa / *Casserole without lid* / Faitout sans couvercle / *Flache Kasserolle ohne Deckel*

CLASS
INDUCTION



REF	Ø cm	H cm	Lts	
P291.120	20	8,0	2,50	1
P291.124	24	9,5	4,30	1
P291.128	28	11,0	6,70	1
P291.130	30	12,0	8,40	1
P291.132	32	12,5	10,00	1
P291.135	35	14,0	13,60	1
P291.140	40	15,5	19,50	1
P291.145	45	17,0	27,00	1
P291.150	50	20,0	39,00	1
P291.160	60	23,0	65,00	1

P2921 Cacerola alta sin tapa / *Sauce pot without lid* / Braisière sans couvercle / *Hohe Kasserolle ohne Deckel*

CLASS
INDUCTION



REF	Ø cm	H cm	Lts	
P292.120	20	13,0	4,00	1
P292.124	24	14,0	6,30	1
P292.128	28	17,5	10,20	1
P292.130	30	18,0	12,70	1
P292.132	32	19,0	15,20	1
P292.135	35	21,0	20,20	1
P292.140	40	25,0	31,40	1
P292.145	45	28,0	44,50	1
P292.150	50	30,0	59,00	1
P292.160	60	35,0	99,00	1

P2931 Paellera sin tapa / *Paella pan without lid* / Plat à paella sans couvercle / *Paellapfanne ohne Deckel*

CLASS
INDUCTION



REF	Ø cm	H cm	Lts	
P293.132	32	6,0	4,70	1
P293.135	35	7,0	6,70	1
P293.140	40	8,0	10,00	1

P299 Tapa / *Lid* / Couvercle / *Deckel*



REF	Ø cm	
P299.020	20	1
P299.024	24	1
P299.028	28	1
P299.030	30	1
P299.032	32	1
P299.035	35	1
P299.040	40	1
P299.045	45	1
P299.050	50	1
P299.060	60	1

COOL • LINE



 **INDUCTION**

Cuerpo en acero inoxidable 18/10 /

Cookware body made of 18/10 Stainless Steel /

Corps en acier inoxydable 18/10 /

Kochbedarf aus Edelstahl 18/10



Asas ergonómicas fabricadas en acero inoxidable de fundición /

Ergonomic handles made of cast st/steel

Ansesen fonte d'acier inoxydable, ergonomiques /

Griffe aus gussedelstahl hergestellt. Absolut ergonomisch



Fondo termo difusor técnico /

Tech sandwich base /

Fond thermo-diffuseur technique /

Tech-thermodiffusionsboden



Tapa con diseño especial para apoyo en asa lateral /

Special lid designed to hold on the side handle /

Couvercle spécial, conçu pour reposer sur la poignée /

Spezielles deckeldesign zum halten im seitengriff



Ref. color /
Ref. colour /
Ref. couleur couvercle /
Art.Nr. Farben

EXCLUSIVE

P4906CO Cacerola alta con tapa / Sauce pot with lid / Braisière avec couvercle / Hohe Kasserolle mit Deckel



EXCLUSIVE



REF	Ø cm	H cm	Lts	
P490.620 + COLOR	20	13,0	3,70	1
P490.624 + COLOR	24	14,0	5,80	1
P490.628 + COLOR	28	17,5	9,50	1
P490.632 + COLOR	32	19,0	14,00	1

P4907CO Cacerola baja con tapa / Casserole with lid / Faitout avec couvercle / Flache Kasserolle mit Deckel



EXCLUSIVE



REF	Ø cm	H cm	Lts	
P490.724 + COLOR	24	9,5	3,90	1
P490.728 + COLOR	28	11,0	5,80	1
P490.732 + COLOR	32	12,5	8,90	1

P4909 Paellera con tapa / Paella pan with lid / Plat à paella avec couvercle / Paellapfanne mit Deckel



EXCLUSIVE



REF	Ø cm	H cm	Lts	
P490.928 + COLOR	28	6,0	3,70	1
P490.932 + COLOR	32	6,0	4,70	1

P4900CO Cazo recto / Saucepan / Casserole / Gerade Stielkasserolle



EXCLUSIVE



REF	Ø cm	H cm	Lts	
P490.014 + COLOR	14	7,0	1,00	1
P490.016 + COLOR	16	7,5	1,50	1

IDEA COOKWARE



FOOD CONTACT
APPROVED

 INDUCTION



induction



gas



vitro



electric

LOS CONCURSANTES DE
CONTESTANTS
LES CONCURENENTS DE
DIE KANDIDATEN

MASTERCHEF
COCINAN CON
COOK WITH
CUISINENT AVEC
KOCHEIN MIT

IDEA

Muchas veces lo más importante es la idea /
So often, the most important point is the idea /
Très souvent, le plus important c'est l'idée /
Oftmals ist die Idee das Wichtigste

Asas en acero inoxidable /
Stainless steel handles /
Anses en acier inoxydable /
Griffe aus edelstahl

Acero inoxidable pulido brillante /
Stainless steel mirror finished /
Acier inoxydable polissage /
Glänzend polierter edelstahl

Fondo difusor encapsulado all over /
All over encapsulated sandwich base /
Fond thermodiffuseur encapsulé all over /
All over verkapselter thermodiffusionsboden

ALL OVER TECHNOLOGY

Es el nombre que recibe el proceso tecnológico que aplicamos para realizar la soldadura del fondo difusor, que permite rellenar todo el interior del fondo con una espesa capa de aluminio, sin dejar cavidades vacías y permitiendo una difusión del calor más rápida y uniforme hasta los bordes del recipiente.

Its name derives from the technological process that we apply to perform the welding of the heat diffusing base, which allows the entire inside of the base to be filled with a thick layer of aluminium, without leaving empty cavities and which allows a faster and more uniform heat diffusion right to the edges of the vessel.

C'est le nom du processus technologique que nous appliquons pour la soudure du fond diffuseur, qui permet de remplir tout l'intérieur du fond d'une couche épaisse d'aluminium, sans laisser de cavités vides et permettant une diffusion de la chaleur plus rapide et uniforme jusqu'aux bords du récipient.

Das ist die Bezeichnung des technologischen Prozesses, den wir anwenden, um das Verschweißen des Diffusionsbodens durchzuführen. Damit wird ermöglicht, den kompletten Bodenkern mit einer dicken Aluminiumschicht auszufüllen, ohne dass dabei Hohlräume entstehen, wodurch eine schnelle und gleichmäßige Wärmeverteilung bis hin zum Topfrand sichergestellt wird.

Inox / st/steel
Rostfreier stahl

Aluminio / aluminium

Inox magnético /
Magnetic st/steel /
Inox magnétique /
Magnetischer edelstahl

P458 Olla con tapa / Stock pot with lid / Marmite traiteur avec couvercle / Kochtopf mit Deckel



REF	Ø cm	H cm	Lts	
P458.024	24	20,0	9,00	1
P458.028	28	24,0	14,50	1

P456 Cacerola alta con tapa / Sauce pot with lid / Braisière avec couvercle / Hohe Kasserolle mit Deckel



REF	Ø cm	H cm	Lts	
P456.016	16	11,0	2,20	1
P456.020	20	13,0	4,10	1
P456.024	24	14,0	6,30	1
P456.028	28	16,0	9,80	1

P457 Cacerola baja con tapa / Casserole with lid / Faitout avec couvercle / Flache Kasserolle mit Deckel



REF	Ø cm	H cm	Lts	
P457.016	16	7,5	1,50	1
P457.020	20	8,0	2,50	1
P457.024	24	9,5	4,30	1
P457.028	28	11,0	6,70	1

P454 Cazo recto / Saucepan / Casserole / Gerade Stielkasserolle



REF	Ø cm	H cm	Lts	
P454.012	12	7,0	0,70	1
P454.014	14	7,0	1,00	1
P454.016	16	7,5	1,50	1
P454.018	18	9,0	2,30	1

 INDUCTION

Tapa plana /
Flat lid /
Couvercle plain /
Flachem deckel

Asas tubulares resistentes al calor /
Heat-resistant tubular handles /
Ansestubulaires résistantes à la chaleur /
Hitzebeständigen rohrgriffen

Fondo termo difusor encapsulado /
Encapsulated sandwich base /
Fond thermo-diffuseur encapsulé /
Kapselförmiger thermodiffusionsunterboden



P2706 Cacerola alta con tapa / Sauce pot with lid / Braisière avec couvercle / Hohe Kasserolle mit Deckel



REF	Ø cm	H cm	Lts	
P270.620	20	13,0	4,00	1
P270.624	24	14,0	6,00	1
P270.628	28	16,0	9,50	1

P2707 Cacerola baja con tapa / Casserole pot with lid / Faitout avec couvercle / Flache Kasserolle mit Deckel



REF	Ø cm	H cm	Lts	
P270.716	16	7,5	1,50	1
P270.720	20	8,0	2,50	1
P270.724	24	9,5	4,00	1
P270.728	28	11,0	6,50	1

P2701 Cazo recto / Saucepan / Casserole / Kasserolle



REF	Ø cm	H cm	Lts	
P270.114	14	7,0	1,00	1
P270.116	16	7,5	1,50	1
P270.118	18	9,0	2,00	1



gas



vitro



electric



Batería de aluminio puro extra fuerte /
Pure extra strength aluminum cookware /
Batterie de cuisine en aluminium pur extra fort /
Kochbedarf Extra Starke Aluminium

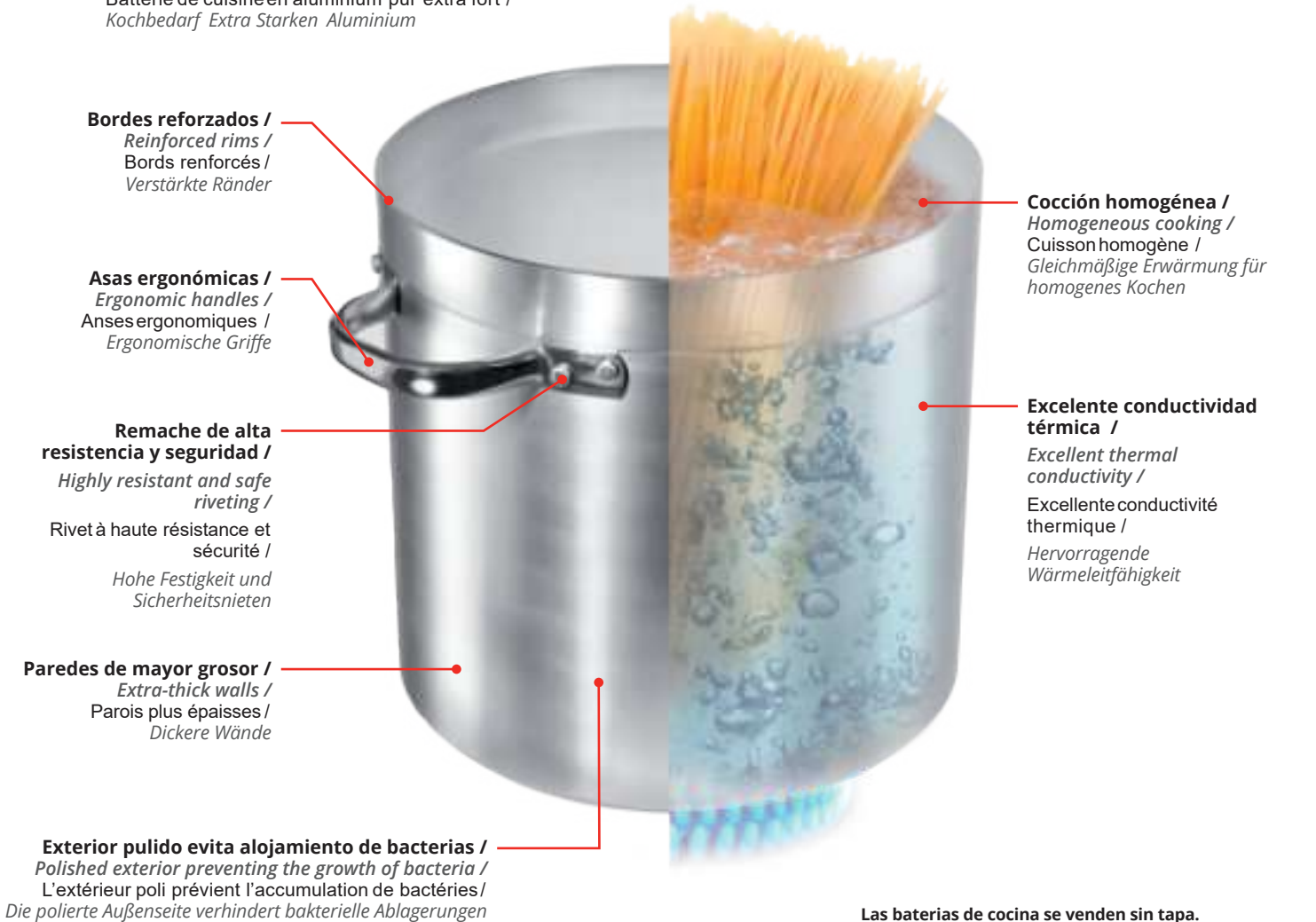

Bordes reforzados /
Reinforced rims /
Bords renforcés /
Verstärkte Ränder

Asas ergonómicas /
Ergonomic handles /
Anses ergonomiques /
Ergonomische Griffe

Remache de alta resistencia y seguridad /
Highly resistant and safe riveting /
Rivet à haute résistance et sécurité /
Hohe Festigkeit und Sicherheitsnieten

Paredes de mayor grosor /
Extra-thick walls /
Parois plus épaisses /
Dickere Wände

Exterior pulido evita alojamiento de bacterias /
Polished exterior preventing the growth of bacteria /
L'extérieur poli prévient l'accumulation de bactéries /
Die polierte Außenseite verhindert bakterielle Ablagerungen

Cocción homogénea /
Homogeneous cooking /
Cuisson homogène /
Gleichmäßige Erwärmung für homogenes Kochen

Excelente conductividad térmica /
Excellent thermal conductivity /
Excellente conductivité thermique /
Hervorragende Wärmeleitfähigkeit

Las baterías de cocina se venden sin tapa.

The cookware sold without lids.

Les batteries de cuisine sont-elles vendues sans couvercle.

Das Kochgeschirr wird ohne Deckel verkauft.

Fabricadas en chapas de aluminio de hasta 5 mm (según diámetro) de puro aluminio 100% reciclable.

Made of 100% recyclable pure aluminum sheets of up to 5 mm (depending on diameter).

Faites de tôles d'aluminium à 100 % recyclable, jusqu'à 5 mm d'épaisseur (selon le diamètre).

Hergestellt aus Aluminiumblechen von bis zu 5 mm Stärke (je nach Durchmesser des Produktes), die zu 100 % aus recycelbarem Aluminium bestehen.

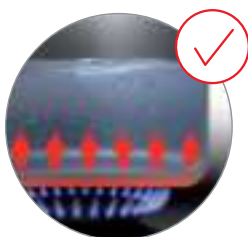

Espesor del fondo que evita la deformación, en contacto total con la fuente de calor que permite un mayor rendimiento energético.

Base thickness that prevents deformation, in full contact with the heat source, thus improving energy efficiency.

L'épaisseur du fond évite sa déformation, il est intégralement en contact avec la source de chaleur, ce qui permet un meilleur rendement énergétique.

Die außergewöhnliche Dicke des Bodens verhindert Verformungen, wodurch der Topf stets in vollem Kontakt mit der Wärmequelle steht und so eine größere Energieeffizienz ermöglicht.

P1183 Olla sin tapa / Stock pot without lid / Marmite traiteur sans couvercle / Kochtopf ohne Deckel



REF	Ø cm	H cm	Lts	
P118.324	24	24,0	10,00	1
P118.328	28	28,0	16,50	1
P118.332	32	32,0	25,50	1
P118.335	35	35,0	33,60	1
P118.340	40	40,0	50,00	1
P118.345	45	45,0	72,00	1
P118.350	50	50,0	98,00	1
P118.360	60	60,0	155,00	1

P1173 Cacerola baja sin tapa / Casserole without lid / Faitout sans couvercle / Flache Kasserolle ohne Deckel



REF	Ø cm	H cm	Lts	
P117.324	24	9,5	4,30	1
P117.328	28	11,0	6,70	1
P117.332	32	12,5	10,00	1
P117.335	35	14,0	13,00	1
P117.340	40	16,0	20,00	1
P117.345	45	18,0	28,00	1
P117.350	50	21,0	41,00	1
P117.360	60	25,0	70,00	1

P1163 Cacerola alta sin tapa / Sauce pot without lid / Braisière sans couvercle / Hohe Kasserolle ohne Deckel



REF	Ø cm	H cm	Lts	
P116.324	24	14,0	6,30	1
P116.328	28	17,5	10,20	1
P116.332	32	19,0	15,20	1
P116.335	35	21,0	20,20	1
P116.340	40	25,0	31,40	1
P116.345	45	28,0	44,50	1
P116.350	50	31,0	60,80	1
P116.360	60	37,0	104,60	1

P1153 Paellera sin tapa / Paella pan without lid / Plat à paella sans couvercle / Paellapfanne ohne Deckel



REF	Ø cm	H cm	Lts	
P115.320	20	5,5	1,75	1
P115.324	24	6,0	2,75	1
P115.340	40	8,0	10,00	1

P1123 Tapa / Lid / Couvercle / Deckel



REF	Ø cm	
P112.324	24	1
P112.328	28	1
P112.332	32	1
P112.335	35	1
P112.340	40	1
P112.345	45	1
P112.350	50	1
P112.360	60	1

P1063 Sautex / Sauté pan / Sauteuse / Sauteuse



REF	Ø cm	H cm	Lts	
P106.320	20	5,5	1,75	1
P106.324	24	6,0	2,75	1

P1043 Cazo recto / Saucepan / Casserole / Gerade Kasserolle



REF	Ø cm	H cm	Lts	
P104.318	18	9,0	2,00	1
P104.320	20	10,0	3,00	1
P104.324	24	12,0	5,00	1

P1033 Cazo bombeado / Rounded saucepan / Casserole bombée / Kugelige Stielkasserolle mit Schüttrand



REF	Ø cm	H cm	Lts	
P103.322	22	11,0	3,00	1

Ver productos en / See products on / Voir produits en page / Siehe produkte in

P.
67

SARTÉN ALUMINIO ANTIATHERENTE /
ALUMINIUM NON-STICK FRY PAN /
POËL ANTI-ADHÉSIVE /
ALUMINIUM ANTIHAFT BRATPFANNE



BLACK SERIES



Fabricada en aluminio de fundición de gran resistencia a la deformación y con excelentes prestaciones térmicas /

Manufactured from cast aluminium offering high deformation resistance and excellent thermal properties /

Fabriqué en fonte d'aluminium très résistante à la déformation et dotée d'excellentes performances techniques /

Aus Aluguss von hoher formbeständigkeit und mit ausgezeichneter wärmeleitfähigkeit

Antiadherente de alta resistencia /
Highly resistant non-stick surface /

Antiadhésif très résistant /
Antihaftbeschichtung von hoher beständigkeit

Exterior: pintura negra resistente a altas temperaturas /
Exterior: black, high temperature resistant paint /

Extérieur: peinture noire résistante aux températures élevées /
Aussen: hochtemperaturbeständige schwarze lackierung

P141 Cazuela baja sin tapa / Shallow casserole without lid / Cocotte sans couvercle / Flache Kasserolle ohne Deckel



Fondo torneado /
Ground base /
Fond dressé /
Gedrechselter
Unterboden



Ideal para presentación.
Ideal for food presentation.
Idéal pour présentation.
Ideal für die Präsentation.

***MINI-SIZE**

P141.014
P141.016
P141.020



REF	Ø cm	H cm	
NEW! P141.014*	14	4,0	1
P141.016*	16	5,0	1
P141.020*	20	5,5	1
P141.024	24	5,8	1
P141.028	28	7,5	1
P141.032	32	8,0	1
P141.036	36	8,5	1
P141.040	40	10,0	1

P151 Cazuela alta sin tapa / Deep casserole without lid / Braisière sans couvercle / Hohe Kasserolle ohne Deckel



Fondo torneado /
Ground base /
Fond dressé /
Gedrechselter
Unterboden



Ideal para presentación.
Ideal for food presentation.
Idéal pour présentation.
Ideal für die Präsentation.

***MINI-SIZE**

P151.012
P151.014
P151.016



REF	Ø cm	H cm	
P151.012*	12	8,5	1
P151.014*	14	8,5	1
P151.016*	16	8,0	1
P151.020	20	9,0	1
P151.024	24	10,0	1
P151.028	28	12,0	1
P151.032	32	14,0	1

P161 Paella sin tapa / Paella pan without lid / Plat à paella sans couvercle /



REF	Ø cm	H cm	
P161.034	34	4	1
P161.038	38	4	1



Ideal para hornos, brasa y barbacoa /
Ideal for ovens, grills and barbecues /
Idéal pour fours, grill et barbecue /
Ideal für Öfen, Kohlenfeuer und Grillanlagen

BLACK FORGED



FOOD CONTACT
APPROVED

BATERIA /
COOKWARE /
BATTERIE

**FULL
INDUCTION**



Tapa de cristal /
Glass lid /
Couvercle en verre /
Glasseckel

**Aluminio forjado con antiadherente en su interior,
i pintura resistente a altas temperaturas en el exterior /**
*Forged aluminium with a non-stick interior surface and with high
temperature resistant paint on the outside /*

*Aluminium avec revêtement antiadhésif à l'intérieur, et peinture
résistante aux températures élevées à l'extérieur /*
*Schmiedealuminium mit antihftbeschichtung innen und
hochtemperaturbeständiger lackierung aussen*

**Chapa de acero inoxidable ferrítico que
cubre la totalidad del fondo /**

*Ferritic stainless steel sheet that covers
the whole of the base /*

*Plaque en acier inoxydable ferritique qui
couvre tout le fond /*

*Schicht aus ferritischem edelstahl deckt den
kompletten boden ab*

**Fondo difusor completo que permite un excelente
rendimiento en cocinas de inducción**

*Full heat-diffusing base which offers excellent performance on
induction hobs /*

*Fond diffuseur complet offrant une haute performance sur les
cuisinières a induction /*

*Kompletter wärmeleitboden für eine ausgezeichnete leistung auf
induktions-kochfeldern*

P170

Cacerola alta con tapa / Saucepot with lid /
Braisière avec couvercle / Hohe Kasserolle mit Deckel



Asas de silicona incluidas /
Silicone handles included /
Anses en silicone incluses /
inklusive Silikongriffen



REF	Ø cm	H cm	Lts	
P170.020	20	8,5	2,50	1
P170.024	24	9,0	4,00	1
P170.028	28	12,5	7,50	1

P171

Cacerola baja con tapa / Casserole with lid /
Faitout avec couvercle / Flache Kasserolle mit Deckel

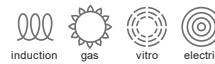

Asas de silicona incluidas /
Silicone handles included /
Anses en silicone incluses /
inklusive Silikongriffen



REF	Ø cm	H cm	Lts	
P171.024	24	7,5	3,00	1
P171.028	28	7,5	4,50	1

P173 Cazo / Saucepan / Casserole / Kasserolle



REF	Ø cm	H cm	Lts	
P173.016	16	8,4	1,50	1

Ver productos en / See products on /
Voir produits en page / Siehe produkte in

**P.
74**

SARTÉN / FRY PAN /
POÊLE/ BRATPFANNE
Mango baquelita / Bakelite handle /
Queue en bakélite / Bakelitestiel





3.1	ACERO INOXIDABLE / ST/STEEL / ACIERINOXYDABLE / EDELSTAHL	64
	INOX PRO	64
	IDEA	66
3.2	ALUMINIO / ALUMINIUM / ALUMINIUM / ALUMINIUM	67
	ALU PRO INDUCTION	67
	ALU PRO NO INDUCTION	68
3.3	MULTIMETAL / MULTI-PLY / MULTI-METAL / MULTIMETALL	71
3.4	ALUMINIO FUNDICIÓN / CAST ALUMINIUM / FONTED'ALUMINIUM / ALUMINIUMGUSS	72
	BLACK PRO	72
	BLACK FORGED	74
	BLACK FIRST	74
3.5	ACERO / STEEL / ACIER / ROSTFREIER STAHL	75
	STEEL PRO	75
	STEEL CLASSIC	77
3.6	PAELLERA / SPANISH PAELLA PAN / PLAT À PAELLA / PAELLAPFANNE	78

MANGOS HANDLES MANCHES STIELE

ERGOS

MAYOR ERGONOMÍA
MORE ERGONOMIC
PLUS ERGONOMIQUE
ERGONOMISCHER



Tubular
Tubular
Tubulaire
Rundgeformt

Los mangos **ERGOS** de Pujadas se caracterizan por estar fabricados en tubo de acero inoxidable. Gracias a un proceso de allanado, lo convierte en un mango ergonómico y aislante del calor.

Estos mangos se presentan con dos agujeros en los dos extremos interiores, para asegurar que ninguna gota de agua quede dentro en el proceso de lavado y ésta salga en forma de vapor durante el calentamiento de la sartén.

*Pujadas **ERGOS** handles are characterized by being made from stainless steel tubing. Thanks to a flattening process, the tubing becomes an ergonomic and heat insulating handle.*

These handles are made with two holes at the two innermost end, to ensure that no water from the washing process remains inside and comes out in the form of steam when the pan is heated.

Les manches **ERGOS** de Pujadas se caractérisent par leur fabrication à partir d'un tube en acier inoxydable. Le processus d'aplanissement obtient un manche ergonomique doté d'une isolation thermique.

Ces manches sont présentés avec deux trous aux deux extrémités intérieures, pour qu'aucune goutte d'eau ne reste à l'intérieur pendant le processus de lavage et que celle-ci sorte sous forme de vapeur lors du chauffage de la poêle.

*Die Pujadas **ERGOS** Stiele sind aus rostfreiem Edelstahl gefertigt und zeichnen sich durch eine runde Form aus. Mithilfe eines speziellen Fertigungsprozesses erhalten wir ergonomisch geformte, hitzeisolierte Stiele.*

Diese Stiele sind mit zwei Öffnungen an den beiden inneren Enden ausgestattet, um sicherzustellen, dass kein Tropfen Wasser vom Spülvorgang zurückbleibt und bei Erhitzen der Pfanne verdampfen kann.

HÉRCULES

MAYOR SUJECIÓN
GREATER STRENGTH
MEILLEURE PRISE
BESSERER HALT



Canal interior
Interior channel
Canal intérieur
Innerer kanal

Bordes pulidos
Smoothed edges
Bords polis
Glatte ränder

Los mangos **HÉRCULES** son aquellos fabricados en chapa plana de hierro recubiertos con una pintura protectora resistente a altas temperaturas, que evita una rápida oxidación. Esta chapa se presenta con los bordes pulidos y con una ligera canal en medio para una mejor sujeción.

***HÉRCULES** handles are made of flat iron sheet coated with a high temperature resistant protective paint, which prevents rapid oxidation. The handles have smoothed edges and a slight channel in the centre for increased strength.*

Les manches **HÉRCULES** sont fabriqués en plaque de fer plate et recouverts d'une peinture protectrice résistante aux températures élevées, qui évite une oxydation rapide. Cette plaque est dotée de bords polis et d'un léger canal au milieu pour une meilleure prise.

*Die **HÉRCULES** Stiele werden aus einem flachen Eisenblech gefertigt, das von einer hochtemperaturbeständigen Schutzlackierung, die ein schnelles Verrosten verhindert, umhüllt ist. Dieses Eisenblech weist glatte Ränder und einen kleinen Kanal in der Mitte für einen besseren Halt auf.*

	ACERO INOXIDABLE / STAINLESS STEEL / ACIER INOXYDABLE / ROSTFREIER STAHL			ALUMINIO / ALUMINIUM / ALUMINIUM / ALUMINIUM	
	INOX PRO	INOX CERAMIC	IDEA	ALU PRO INDUCTION	ALU PRO
REF / ITEM / CODE / ART.NR.	 P. 64	 P. 65	 P. 66	 P. 67	 P. 68
COMPATIBLE CON / COMPATIBLE WITH / COMPATIBLE AVEC / GEEIGNET FÜR	 INDUCTION 	 INDUCTION 	 INDUCTION 	 INDUCTION 	 NO INDUCTION 
PRECIO / PRICE / PRIX / PREIS					
ESPESOR / THICKNESS / EPAISSEUR / DICKE	0,8 mm	0,8 mm	0,7 mm	4 mm	4 mm
ANTIADHERENTE / COATING / REVÊTEMENT / ANTIHAFTBESCHICHTUNG					
MANGO / HANDLE / QUEUE / GRIFF	INOXIDABLE / ST/STEEL / INOXYDABLE / ROSTFREI	INOXIDABLE / ST/STEEL / INOXYDABLE / ROSTFREI	INOXIDABLE / ST/STEEL / INOXYDABLE / ROSTFREI	INOXIDABLE / ST/STEEL / INOXYDABLE / ROSTFREI	INOXIDABLE / ST/STEEL / INOXYDABLE / ROSTFREI
RECOMENDADA / RECOMMENDED / RECOMMANDÉE / EMPFEHLUNG	ALTA RESISTENCIA A LA ABRASIÓN / HIGH RESISTANCE TO ABRASION / HAUTE RÉSISTANCE À L'ABRASION / HOHE RESISTENZ GEGEN VERSCHLEISS	ALTA RESISTENCIA A LA ABRASIÓN / HIGH RESISTANCE TO ABRASION / HAUTE RÉSISTANCE À L'ABRASION / HOHE RESISTENZ GEGEN VERSCHLEISS	RESISTENCIA PROFESIONAL / PROFESSIONAL STRENGTH / DURETÉ PROFESSIONNEL / PROFESSIONELLE RESISTENZ	ALTA RESISTENCIA A LA ABRASIÓN / HIGH RESISTANCE TO ABRASION / HAUTE RÉSISTANCE À L'ABRASION / HOHE RESISTENZ GEGEN VERSCHLEISS	COCCIÓN A FUEGO LENTO / SLOW BAKING / CUISSON À FEU LENT / KOCHEN MIT KLEINER FLAMME



INDUCTION



NO INDUCTION

**PROFESIONAL / PROFESSIONAL /
PROFESSIONNEL / PROFESSIONELL**

SARTENES /
FRY PANS /
POÊLES

MULTIMETAL / MULTI-PLY / MULTI-METAL / MULTIMETALL		ALUMINIO FUNDICIÓN / CAST ALUMINIUM / FONTED'ALUMINIUM / ALUMINIUMGUSS		ACERO / STEEL / ACIER / STAHL	
MULTIMETAL	BLACK PRO	BLACK FORGED	BLACK FIRST	STEEL PRO	STEEL CLASSIC
P. 71	P. 72	P. 74	P. 74	P. 75	P. 77
INDUCTION	INDUCTION	INDUCTION	NO INDUCTION	INDUCTION	INDUCTION
3,5 mm	4 mm	3 mm	4 mm	2 mm	1,5 mm
					NINGUNO / NONE / AUCUN / KEINE
INOXIDABLE / ST/STEEL / INOXYDABLE / ROSTFREI	INOXIDABLE / ST/STEEL / INOXYDABLE / ROSTFREI	BAQUELITA / BAKELITE / BAKELIT (MAX. TEMP. 160 °C)	MADERA / WOODEN / BOIS / HOLZ	INOXIDABLE / ST/STEEL / INOXYDABLE / ROSTFREI	HIERRO / FLAT IRON / FER / EISEN
HOMOGENEIDAD Y EFICACIA TÉRMICA / HOMOGENEITY AND THERMAL EFFECTIVENESS / HOMOGÉNÉITÉ ET EFFICACITÉ THERMIQUE / HOMOGENITÄT UND WÄRMEFFIZIENZ	ROBUSTEZ Y BUEN DESLIZAMIENTO / ROBUSTNESS AND GOOD SLIDING / ROBUSTESSE ET BON GLISSEMENT / ROBUSTHEIT UND GUTES RUTSCHEN	ROBUSTEZ Y EFICIENCIA / ROBUSTNESS AND EFFICIENCY / ROBUSTESSE ET EFFICACITÉ / ROBUSTHEIT UND EFFIZIENZ	ROBUSTEZ Y BUEN DESLIZAMIENTO / ROBUSTNESS AND GOOD SLIDING / ROBUSTESSE ET BON GLISSEMENT / ROBUSTHEIT UND GUTES RUTSCHEN	ALTAS TEMPERATURAS / HIGH TEMPERATURES / HAUTES TEMPERATURES / HOHE TEMPERATUREN	SELLAR, FREIR, DORAR / SEALING, FRYING, BROWNING / CULOTTAGE, FRIRE ET DORER / ANBRATEN, FRITIERN, ANBRÄUNEN



INOX PRO



Probablemente la mejor sartén del mundo - máxima resistencia a la abrasión y de larga durabilidad.

Probably the best frying pan in the world - maximum resistance to abrasion and long-lasting.

Probablement la meilleure poêle du monde - résistance maximale à l'abrasion et longue durée de vie.

Vermutlich die beste Pfanne der Welt - maximale Verschleißfestigkeit und lange Lebensdauer.

INOX PRO

P220 Sartén antiadherente excalibur "ERGOS" / Non-stick "ERGOS" excalibur fry pan /
Poêle anti-adhésive excalibur "ERGOS" / Bratpfanne Antihaft excalibur "ERGOS"



Antiadherente / Non-stick coating /
Anti-adhésif / Antihaftbeschichtung



REF	Ø cm	H cm	
P220.018	18	3,5	1
P220.020	20	3,8	1
P220.022	22	4,2	1
P220.024	24	4,6	1
P220.026	26	5,0	1
P220.028	28	5,5	1
P220.032	32	6,0	1
P220.036	36	6,0	1
P220.040	40	6,5	1

Fondo sandwich / Sandwich bottom /
Fond sandwich / Sandwichboden

Detalle tratamiento antiadherente / Non-stick coating treatment /
Détail application anti-adhésif / Behandlung mit antihaftbeschichtung



Para dar rugosidad a la superficie de la pieza se chorrea con elementos abrasivos y con ello se logra un buen anclaje del Excalibur.

The surface of the substrate is blasted with an abrasive to roughen it, so other elements in the Excalibur process adhere to it better.

Afin de la rendre rugueuse, la surface de la pièce est sablée avec un abrasif; ceci permettra une excellente tenue du procédé Excalibur.

Um der Oberfläche eine Rauheit zu geben wird sie mit rauen Elementen bestrahlt. Dies erlaubt einen exzellenten Halt von anderen Elementen im Excalibur Prozess.



La parte más importante del proceso: la pulverización y deposición de las partículas fundidas de una aleación de acero inoxidable, patentada por whitford.

Then, the most important part: White-hot particles of a special stainless steel (protected by patent by whitford) are sprayed onto the roughened surface.

Le processus plus important: des particules d'un acier inoxydable spécial (protégé par brevet par whitford) sont chauffées à blanc et pulvérisées sur la pièce.

Der wichtigste Prozessschritt: Die Pulverisierung und Ablagerung der Schmelzpartikel formt sich zu einer speziellen Legierung (whitford Legierung) patentiert.



Las partículas se enfrían, formando parte integral de la superficie con "picos" y "valles" que permiten alojar las capas de antiadherente de forma permanente.

The particles cool and harden, bonded to the surface, forming a series of "peaks and valleys" that provide a permanent base for the non-stick coatings.

Ces particules se refroidissent, forment des crêtes et des vallées constituant une excellente base permanente d'accrochage et de renforcement de l'anti-adhésif.

Die Partikel kühlen sich ab und integrieren sich in der Oberfläche in Form von "Höhen und Tiefen". Dies ermöglicht eine permanente Grundlage für die Antihaftbeschichtung.



Finalmente se aplican varias capas de fluoropolímeros que rellenan los "valles" y cubren los "picos", que protegen el recubrimiento antiadherente.

Several coats of tough fluoropolymers fill the "valleys" and cover the "peaks", held permanently in place by the special stainless steel "peaks".

Des couches d'anti-adhésif très résistant sont appliquées; elles remplissent les vallées, recouvrent juste le haut des crêtes qui les maintiennent fermement en place.

Schliesslich werden unterschiedliche Schichten aus Fluorpolymer über die "Höhen und Tiefen" aufgetragen, um die Antihaftbeschichtung zu schützen.

COOL • LINE



EXCLUSIVE

P4902CO Sartén antiadherente / Non-stick fry pan / Poêle anti-adhésive / Bratpfanne Antihaft



Antiadherente / Non-stick coat
Anti-adhésif / Antihftbeschichtu.



REF	Ø cm	H cm	
P490.220 + COLOR	20	3,8	1
P490.224 + COLOR	24	4,6	1
P490.228 + COLOR	28	5,5	1

Fondo sandwich / Sandwich bottom /
Fond sandwich / Sandwichboden.

Ref. color / Ref. colour /
Ref. couleur couvercle / Art.Nr. Farben



SARTENES /
FRY PANS /
POÊLES

INTENSIVE



P2208 Sartén antiadherente cerámico / Fry pan with ceramic non-stick coating / Poêle revêtement anti-adhésif céramique / Bratpfanne keramische Antihftbeschichtung



Antiadherente / Non-stick coating /
Anti-adhésif / Antihftbeschichtung



REF	Ø cm	H cm	
P220.820	20	3,5	1
P220.824	24	4,6	1
P220.828	28	5,5	1
P220.832	32	6,0	1

EXPERT



P213 Sartén "EXPERT" / "EXPERT" fry pan / Poêle "EXPERT" / Bratpfanne "EXPERT"



REF	Ø cm	H cm	
P213.018	18	3,5	1
P213.020	20	3,8	1
P213.022	22	4,2	1
P213.024	24	4,6	1
P213.026	26	5,0	1
P213.028	28	5,5	1
P213.032	32	6,0	1
P213.036	36	6,0	1
P213.040	40	6,5	1

Fondo sandwich /
Sandwich bottom /
Fond sandwich /
Sandwichboden.

P2393 Wok fondo redondo / Round base wok / Wok à fond rond / Wok mit rundem Boden



REF	Ø cm	H cm	Lts	
P239.336	36	10,0	6,00	1



P2392 Wok fondo plano / Flat base wok / Wok à fond plain / Wok mit flachem Boden



REF	Ø cm	H cm	Lts	
P239.236	36	9,0	5,50	1



IDEA



P459 Sartén / Fry pan / Poêle / Bratpfanne



REF	Ø cm	H cm	
P459.020	20	4,5	1
P459.024	24	5,0	1
P459.028	28	5,5	1



ALL
OVER
TECH

Ver productos en / See products on / Voir produits en page / Siehe produkte in

P.
50

IDEA
collection





FOOD CONTACT
APPROVED

ALU PRO



P1289 Sartén antiadherente fondo inducción "HERCULES" / Non-stick induction fry pan "HERCULES" / Poêle anti-adhésive fond induction "HERCULES" / Bratpfanne Antihaft Induktion "HERCULES"



Antiadherente / Non-stick coating /
Anti-adhésif / Antihftbeschichtung



Fondo chapa inox. inducción
St/Steel sheet induction bottom
Fond plaque inox. induction
Rostfreier Stahlblechunterboden Induktion

REF	Ø cm	H cm	
P128.920	20	4,0	12
P128.924	24	4,5	6
P128.928	28	5,0	6
P128.932	32	5,5	6

P1209 Sartén antiadherente fondo inducción "ERGOS" / Non-stick induction fry pan "ERGOS" / Poêle anti-adhésive fond induction "ERGOS" / Bratpfanne Antihaft Induktion "ERGOS"



Antiadherente / Non-stick coating /
Anti-adhésif / Antihftbeschichtung



Fondo chapa inox. inducción
St/Steel sheet induction bottom
Fond plaque inox. induction
Rostfreier Stahlblechunterboden Induktion

REF	Ø cm	H cm	
P120.920	20	4,0	12
P120.924	24	4,5	6
P120.928	28	5,0	6
P120.932	32	5,5	6

P1208 Sartén con antiadherente cerámico / Fry pan with ceramic non-stick coating / Poêle à revêtement anti-adhésif céramique / Bratpfanne mit keramischer Antihftbeschichtung



Antiadherente / Non-stick coating /
Anti-adhésif / Antihftbeschichtung



Fondo chapa inox. inducción
St/Steel sheet induction bottom
Fond plaque inox. induction
Rostfreier Stahlblechunterboden Induktion

REF	Ø cm	H cm	
P120.820	20	4,0	12
P120.824	24	4,5	6
P120.828	28	5,0	6
P120.832	32	5,5	6

3.2 SARTENES / FRY PANS / POÊLES/ BRATPFANNEN

ALUMINIO / ALUMINIUM /
ALUMINIUM / ALUMINIUM

ALU PRO



Fabricadas en aluminio con recubrimiento antiadherente, adaptadas a todo tipo de cocinas excepto inducción. No aptas para hornos.

Made of aluminium with non-stick coating, suitable for any kind of stove except induction and oven.

Fabriquéees en aluminio avec revêtement anti-adhésif, recommandées pour tout type de feux, sauf induction. Ne pas utiliser aux fours.

Herstellung aus Aluminium mit Antihafbeschichtung, Angepasst an Alle Kocharten Ausschliesslich Induktion und Ofen.

P120 Sartén antiadherente "ERGOS" / Non-stick fry pan "ERGOS" / Poêle anti-adhésive "ERGOS" / Antihaft Bratpfanne "ERGOS"



Fácil limpieza / Easy to clean /
Facile à nettoyer / Einfaches Reinigen



REF	Ø cm	H cm	
P120.018	18	4,0	12
P120.020	20	4,0	12
P120.022	22	4,5	12
P120.024	24	4,5	6
P120.026	26	5,0	6
P120.028	28	5,0	6
P120.032	32	5,5	6
P120.036	36	6,0	6
P120.040	40	6,5	6

P128 Sartén antiadherente "HERCULES" / Non-stick fry pan "HERCULES" / Poêle anti-adhésive "HERCULES" / Antihaft Bratpfanne "HERCULES"



Fácil limpieza / Easy to clean /
Facile à nettoyer / Einfaches Reinigen



REF	Ø cm	H cm	
P128.018	18	4,0	12
P128.020	20	4,0	12
P128.022	22	4,5	12
P128.024	24	4,5	6
P128.026	26	5,0	6
P128.028	28	5,0	6
P128.032	32	5,5	6
P128.036	36	6,0	6
P128.040	40	6,5	6

ALU PRO SPECIAL



P128 Sartén antiadherente "HERCULES" mango colores / Non-stick FRY PAN "HERCULES" Coloured handles / Poêle anti-adhésif "HERCULES" Queue à couleurs / Antihaft Bratpfanne "HERCULES" farbige Griffe



REF	Rojo / Red / Rouge / Rot	Amarillo / Yellow / Jaune / Gelb	Azul / Blue / Bleu / Blau	Verde / Green / Vert / Grün	Ø cm	H cm	
P128	1	2	3	4	24	4,5	12
P128	1	2	3	4	28	5,0	12
P128	1	2	3	4	32	5,5	6

- Carnes rojas / Red meat / Viande rouge / Rotes Fleisch
- Carnes blancasy huevos / White meat and eggs / Volaille et oeufs / Weisses Fleisch und Eier
- Pescado / Fish / Poisson / Fisch
- Verdura / Vegetables / Legumes / Gemüse

Ref: P128 + (Color / Colour / Couleur / Farbe) + Ø

P192 Sartén antiadherente ligera "ALU-FIRST" / Non-stick light . Frying pan "ALU-FIRST" / Poêle antiadhésive légère "ALU-FIRST" / Leichtgewichtige Pfanne mit Antihaftbeschichtung "ALU-FIRST"



REF	Ø cm	H cm	
P192.118	18	4,0	12
P192.120	20	4,0	12
P192.124	24	4,5	6
P192.128	28	5,0	6
P192.132	32	5,5	6
P192.136	36	6,0	6
P192.140	40	6,5	6

Se venden sólo por cajas completas
Sold in whole boxes only
Vendues uniquement par boîtes complètes
Nur in kompletten Kartons erhältlich

P127 Sartén "ERGOS" expert / Fry pan "ERGOS" expert / Poêle "ERGOS" expert / Bratpfanne "ERGOS" Expert



REF	Ø cm	H cm	
P127.024	24	4,5	1
P127.028	28	5,0	1
P127.032	32	5,5	1
P127.040	40	6,5	1

P148 Sartén honda "ERGOS" antiadherente / Non-stick sauté pan "ERGOS" / Sautreuse évasée en anti-adhésive "ERGOS" / Antihaft tiefe Bratpfanne "ERGOS"



REF	Ø cm	H cm	
P148.020	20	6,5	1
P148.024	24	7,0	1
P148.028	28	7,5	1
P148.032	32	8,0	1

ALU PRO SPECIAL



Paellera antiadherente /
Non-stick paella pan /
Plat à paella anti-adhésif /
Paellapfanne Antihaft

P124



Asas de acero inox / St/Steel handle /
Ansesen acier inox / Griffe aus rostfreiem Stahl

REF	Ø cm	H cm	
P124.024	24	4,5	1
P124.028	28	5,0	1
P124.032	32	5,5	1
P124.036	36	6,0	1
P124.040	40	6,5	1

Sartén pescado "ERGOS" antiadherente /
Non-stick FRY pan for fish "ERGOS" /
Poêle à poisson "ERGOS" anti-adhésive /
Antihaft Fischbratpfanne "ERGOS"

P125



REF	cm	H cm	
P125.038	38 x 26	5,0	1

Sartén para crêpes "HERCULES" antiadherente /
Non-stick crêpe fry pan "HERCULES" /
Poêle à crêpes "HERCULES" anti-adhésive /
Crêpepfanne "HERCULES" Antihaft

P131



REF	Ø cm	H cm	
P131.022	22	2,5	12
P131.026	26	2,5	12

Sartén para blinis antiadherente /
Non-stick blinis fry pan /
Poêle à blinis anti-adhésive /
Bratpfanne für Blinis Antihaft

P139



IDEA! Especial para huevo frito /
Specially for fried egg /
Spécialement pour œuf frit /
Speziell für Spiegeleier

REF	Ø cm	H cm	
P139.012	12	2,0	36

EASY APOLO

P460 Sartén aluminio antiadherente. Mango baquelita / Aluminium non-stick fry pan. Bakelite handle /
Poêle aluminium anti-adhésive. Queue en bakélite / Aluminiumbratpfanne Antihaft. Bakelitestiel



REF	Ø cm	H cm	
P460.018	18	4,0	12
P460.020	20	4,0	12
P460.024	24	4,0	12
P460.026	26	4,5	12
P460.028	28	4,5	12
P460.030	30	4,5	12
P460.032	32	5,0	12

MULTIMETAL



FOOD CONTACT
APPROVED

Aporta todas las ventajas del aluminio y del acero inoxidable en una sola pieza /

It gets all advantages of the aluminium and the st/steel just in one /

Apporte tous les avantages de l'aluminium et de l'acier inoxydable en une seule pièce /

Bietet alle Vorteile von Aluminium und Edelstahl in einem Einzigen Stück

P2390 / P2394 Wok fondo redondo / Round base wok / Wok à fond rond / Wok runder Boden



REF	Ø cm	H cm	Lts	☐
P239.036	36	10,0	6,00	1
P239.436*	36	10,0	6,00	1

* **Antiadherente / Non-stick coating /**
Anti-adhésif / Antihafbeschichtung



REF.P239.036



REF.P239.436*

P2391 / P2395 Wok fondo plano / Flat base wok / Wok à fond plain / Wok ebener Boden



REF	Ø cm	H cm	Lts	☐
P239.136	36	9,0	5,50	1
P239.536*	36	9,0	5,50	1

* **Antiadherente / Non-stick coating /**
Anti-adhésif / Antihafbeschichtung



REF.P239.136



REF.P239.536*

Ver productos en / See products on / Voir produits en page / Siehe produkte in

P.
289

PLACA DE INDUCCIÓN WOK /
WOK INDUCTION COOKER/
PLAQUE À INDUCTION WOK /
INDUKTIONSKOCHFELD WOK



BLACK PRO



Fabricada en aluminio de fundición de gran resistencia a la deformación y con excelentes prestaciones térmicas /

Manufactured in cast aluminium with excellent resistance to deformation and with excellent thermal properties /

Fabriquée en fonte d'aluminium très résistante à la déformation et dotée d'excellentes performances techniques /

Aus aluguss von hoher formbeständigkeit und mit ausgezeichneter wärmeleitfähigkeit

Mango tubular de acero inoxidable /
*Tubular stainless steel handle /
Manche tubulaire en acier inoxydable /
Rundgriff aus edelstahl*

Antiadherente Eterna de alta resistencia /
*Highly resistant Eterna non-stick surface /
Antiadhesif permanent très résistant /
Hochbeständige permanente antihaftbeschichtung*



P1491 Sartén mango inox / Fry pan st/steel handle / Poêle manche inox / Bratpfanne Edelstahlgriff



REF	Ø cm	H cm	
P149.120	20	5,0	4
P149.124	24	5,0	4
P149.128	28	5,0	4
P149.130	30	5,0	4

P1492 Sartén honda mango inox / Deep fry pan st/steel handle / Poêle haute manche inox / Hohe Bratpfanne Edelstahlgriff



REF	Ø cm	H cm	
P149.228	28	7,5	4

P1493 Wok mango inox / Wok st/steel handle /
Wok manche inox / Wok Edelstahlgriff



REF	Ø cm	H cm	
P149.330	30	9,5	4

P1501 Sartén crêpes mango inox / Crêpe fry pan st/steel handle /
Poêle à crêpes manche inox / Crêpepfanne Edelstahlgriff



REF	Ø cm	H cm	
P150.128	28	1,5	4

P1421 Asador grill mango inox / Grill st/steel handle /
Grill manche inox / Grillpfanne Edelstahlgriff



REF	Ø cm	H cm	
P142.100	28 x 28	4,0	1

Ver productos en / See products on / Voir produits en page / Siehe produkte in

P.
56

CAZUELA /
CASSEROLE /
BRAISIÈRE /
KASSEROLLE



BLACK FORGED SOFT TOUCH



Fondo inducción completo /
Full induction base /
Fond à induction complet /
Kompletter Induktionsboden

Sartén fabricada en aluminio forjado de alta resistencia que ofrece una gran eficiencia energética gracias a su fondo inducción completo, con mango de baquelita soft touch resistente a una temperatura máxima de 160 °C /

Frying pan manufactured in high-resistance forged aluminium which offers excellent energy efficiency thanks to its full induction base with a soft-touch bakelite handle, resistant to temperatures up to 160 °C /

Poêle fabriquée en aluminium revêtu très résistant, offrant une grande efficacité énergétique, grâce à son fond à induction complet avec manche en bakélite soft touch résistant à une température maximale de 160°C /

Pfanne aus Schmiedealuminium von hoher Beständigkeit bietet dank ihres kompletten Induktionsbodens eine hohe Energieeffizienz, mit Bakelit Soft-Touch-Griff beständig bis zu einer Temperatur von maximal 160 °C

P1495 Sartén aluminio forjado / Forged aluminium frying pan / Poêle en aluminium revêtu / Schmiedealu-Pfanne



REF	Ø cm	H cm	
P149.520	20	5,0	1
P149.524	24	5,5	1
P149.528	28	6,0	1

BLACK FIRST



P150 Sartén crêpes mango baquelita / Crêpe fry pan bakelite handle / Poêle à crêpes manche bakélite / Crêpepfanne mit Bakelitstiel



Aluminio de fundición /
Castaluminium /
Fonte d'aluminium /
aluminiumGuss



REF	Ø cm	H cm	
P150.028	28	2,0	12

P142 Asador grill mango madera / Grill wooden handle / Grill queue en bois / Grillpfanne mit Holzstiel



Aluminio de fundición /
Castaluminium /
Fonte d'aluminium /
aluminiumGuss



REF	cm	H cm	
P142.000	29x29	4,3	5

STEEL PRO 1921 SERIES



FOOD CONTACT
APPROVED



40%

Menos de peso que las sartenes tradicionales de hierro /

Less weight than traditional iron pans /

De poids en moins par rapport aux poêles en fer traditionnelles /

Weniger gewicht als die traditionellen eisenbratpfannen

Sartén de acero de fundición ligero de fácil manejo /

Light cast steel fry pan easy to use /

Poêle en fonte d'acier léger, facile à manipuler /

Bratpfanne aus leichtem Gusseisen für eine einfache handhabung



Mango ergonómico, resistente al calor /
Heatproof ergonomic handle /

Manche ergonomique, résistant à la chaleur /

Hitzebeständiger Ergonomischer griff

Extraordinarias propiedades calóricas. Excelente y homogénea distribución del calor /

Extraordinary caloric properties. Excellent and uniform heat distribution /

Propriétés caloriques extraordinaires. Excellent et homogène distribution de la chaleur /

Aussergewöhnliche kalorische eigenschaften. Exzellente und gleichmässige hitzeverteilung

Tres capas de antiadherente de última generación, libre de pfoa /

Last generation three layers non-stick coating. Pfoa free /

Trois couche anti-adhésive de dernière génération. Libre de pfoa /

Dreifache antihafbeschichtung der neuesten generationen. Pfoa frei



Para una cocina rápida y sana, permite cocinar carnes, pescados y verduras a fuego alto, usando muy poco aceite /

For a quick and healthy cooking, it enables you to cook meats, fish, vegetables using high heat and very little oil /

Pour une cuisine rapide et saine, permettant de cuisiner les viandes, poissons et légumes à feu vif, en utilisant très peu d'huile /

Für eine schnelle und gesunde Küche, erlaubt Fleisch, Fisch und Gemüse auf hoher Flamme mit wenig Öl zu braten

P169 Sartén / Fry pan / Poêle / Bratpfanne



REF	Ø cm	H cm	
P169.020	20	4,5	1
P169.024	24	4,5	1
P169.028	28	5,5	1
P169.030	30	5,5	1

P166 Wok con tapa / Wok with lid / Wok avec couvercle / Wok mit Deckel



Tapa de cristal incluida /
Glass lid included /
Couvercle en verre inclus /
Glasdeckel inklusive

REF	Ø cm	H cm	Lts	
P166.032	32	8,0	4,40	1



STEEL CLASSIC

 INDUCTION



FOOD CONTACT
APPROVED

Mango hérocles /
Hercules long handle /
Manche hercules /
Hérocles-stiel

Excelentes propiedades térmicas
y antiadherentes naturales /

Excellent thermal and natural
nonstick properties /

Excellentes propriétés thermiques et
antiadhésives naturelles /

Ausgezeichnete wärmeleit- und
natürliche antihafteigenschaft

Fabricadas en acero /
Manufactured in steel /
Fabriquées en acier /
Aus stahl gefertigt

P1351 Sartén "Lionesa" 1,5 mm / "Lyonnaise" Steel fry pan 1,5 mm /
Poêle "Lyonnaise" 1,5 mm / Bratpfanne "Lyoner" 1,5 mm



REF	Ø cm	H cm	
P135.120	20	4.5	1
P135.124	24	5.0	1
P135.128	28	5.5	1
P135.132	32	6.0	1
P135.140	40	7.0	1

P1353 Wok / Wok / Wok / Wok



REF	Ø cm	H cm	
P135.330	30	9,5	1

P1354 Sartén para crêpes / Crêpe fry pan /
Poêle à crêpes / Crêpesbratpfanne



REF	Ø cm	H cm	
P135.424	24	2,0	1

ACERO / STEEL / ACIER/ STAHL



P994 Paellera valenciana en acero pulido / Black steel spanish paella pan / Plat à paella tôle acier / Spanische Paellapfanne aus poliertem Stahl



REF	Ø cm	RACIONES/ PORTIONS/ PORTIONEN	
P994.020	20	1	1
P994.022	22	1	1
P994.024	24	1	1
P994.026	26	2	1
P994.030	30	4	1
P994.032	32	5	1
P994.034	34	6	1
P994.036	36	7	1
P994.038	38	8	1
P994.040	40	9	1
P994.042	42	10	1
P994.046	46	12	1
P994.050	50	14	1
P994.055	55	16	1
P994.065	65	22	1
P994.080	80	40	1
P994.090	90	50	1

ACERO ESMALTADO / ENAMELLED STEEL / ACIERÉMAILLÉ/ EMAILLIERTE STAHL

P995 Paellera acero esmaltado / Enamelled steel paella pan / Plat à paella acier émaillé / Paellapfanne aus emailliertem Stahl



***MINI-SIZE**



Ideal para tapas
Recommended for snacks
Recommandé pour tapas
Ideal für Snacks

REF	Ø cm	Raciones / Portions / Portionen	
P995.010*	10	-	1
P995.016*	15	-	1
P995.020	20	2	1
P995.026	26	2	1
P995.030	30	4	1
P995.034	34	6	1
P995.036	36	7	1
P995.038	38	8	1
P995.040	40	9	1
P995.042	42	10	1
P995.050	50	14	1
P995.060	60	19	1

P997 Sartén honda esmaltada con asas / Deep enamelled fry pan with handles / Poêle haute avec anses / Tiefe Paellapfanne aus emailliertem Stahl mit Griffen

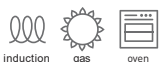

***MINI-SIZE**



Ideal para tapas
Recommended for snacks
Recommandé pour tapas
Ideal für Snacks

REF	Ø cm	Lts	
P997.014 *	14	0,40	1
P997.016 *	16	0,50	1
P997.028	28	3,90	1
P997.032	32	5,30	1
P997.036	36	7,80	1
P997.040	40	9,40	1

PAELLEROS / BURNERS

P998 Paellero esmaltado gas / Enamelled gas burner / Brûleur émaillé / Emailierter Gasbrenner



REF	Ø cm	Círculos / Circles / Cercles / Kreis	Kw	
P998.035	35	2	9,4	1
P998.050	50	2	14,1	1
P998.070	70	3	24,1	1

Válido para gas butano y propano NO para gas ciudad /
Valid only for gas butane and propane /
Valable uniquement pour gazbutane et propane /
Geeignet nur für Butan- und Propangas

Ref. P998.035

Para paelleras de 20 a 50 cm Ø
For paella pans from Ø 20 to 50 cm
Pour plats à paella de 20 à 50 cm Ø
Für Paellapfannen von 20 bis 50 cm Ø

Ref. P998.050

Para paelleras de 36 a 70 cm Ø
For paella pans from Ø 36 to 70 cm
Pour plats à paella de 36 à 70 cm Ø
Für Paellapfannen von 36 bis 70 cm Ø

Ref. P998.070

Para paelleras de 36 a 90 cm Ø
For paella pans from Ø 36 to 90 cm
Pour plats à paella de 36 à 90 cm Ø
Für Paellapfannen von 36 bis 90 cm Ø

P999 Trípode paellero / Base for burner / Pied pour brûleur / Dreifussständer für Gasbrenner



REF	
P999.000	1

Plegable apto para paelleros de 2 y 3 círculos /
Folding valid for 2 and 3 circles burners /
Pliant valable pour brûleurs de 2 et 3 cercles /
Klappbar geeignet für 2 bis 3 Kreisgasbrenner

Ver productos en / See products on / Voir produits en page / Siehe produkte in

P.
469

COOKWARE PASSION & MEDITERRANEAN





HORNO Y RUSTIDERAS /
OVEN AND ROAST PAN /
FOUR ET PLAQUES À RÔTIR /
OFEN- UND BRATFORMEN

4.1	RUSTIDERAS / ROAST PANS / PLAQUES À RÔTIR / BRÄTER	82
4.2	BANDEJAS HORNO GASTRONORM / GASTRONORM SHEET PANS / PLAQUES FOUR GASTRONORME / GASTRONORM OFENBLECHE	84
4.3	BANDEJAS PASTELERÍA / PASTRY TRAYS / PLAQUES À PÂTISSERIE / PATISSERIETABLETT	86
4.4	REJILLAS / GRIDS / GRILLES / ROST	88
4.5	BANDEJAS ESPECIALES / SPECIAL BAKING SHEET / PLAQUE FOUR SPÉCIALE / SPEZIALBLECHE	89
4.6	BANDEJAS PARA PIZZA / PIZZA BAKING SHEETS / PLAQUES À PIZZA / PIZZABLECHE	91
4.7	ACCESORIOS HORNO / OVEN ACCESSORIES / ACCESSOIRES FOUR / OFENACCESSORIES	92

**4.1 HORNO Y RUSTIDERAS / OVEN AND ROAST PAN /
FOURET PLAQUE À RÔTIR/ OFEN UND BRATFORMEN**

**RUSTIDERAS /
ROAST PANS /
PLAQUES À RÔTIR /
BRÄTER**



P309 Rustidera asas móviles / Roast pan falling handles /
Plaque à rôtir anses tombantes / Bräter mit beweglichen Griffen

INOX - ST/STEEL
EDELSTAHL
18/10

REF	cm (int)	cm (ext)	H cm	Lts	
P309.040	40 x 30	43 x 33	6,5	6,50	1
P309.050	50 x 35	54 x 39	7,0	11,00	1
P309.060	60 x 40	64 x 44	9,0	19,00	1



P113 Rustidera asas móviles / Roast pan falling handles /
Plaque à rôtir anses tombantes / Bräter mit beweglichen Griffen

**ALUMINIO /
ALUMINIUM**



REF	cm	H cm	Lts	
P113.035	35 x 27	5,5	5,00	1
P113.040	40 x 30	6,5	6,30	1
P113.050	50 x 35	7,0	10,80	1
P113.060	60 x 40	9,0	19,00	1
P113.070	70 x 45	10,0	27,70	1



P122 Rustidera antiadherente asas móviles / Non-stick roast pan falling handles /
Plaque à rôtir anti-adhésive anses tombantes / Bräter mit beweglichen Griffen

ALUMINIO /
ALUMINIUM

REF	cm	H cm	Lts	
P122.040	40 x 30	6,5	6,30	1
P122.050	50 x 35	7,0	10,80	1
P122.060	60 x 40	9,0	19,00	1



P114 Rustidera asas fijas / Roast pan fixed handles /
Plaque à rôtir avec poignées fixes / Bräter mit festen Griffen

ALUMINIO /
ALUMINIUM

REF	cm	H cm	Lts	
P114.040	40 x 30	6,5	6,30	1
P114.050	50 x 35	7,0	10,80	1
P114.060	60 x 40	9,0	19,00	1
P114.070	70 x 45	10,0	27,70	1



BLACK ELEGANCE

P1145 Rustidera aluminio presentación antiadherente / Non-stick presentation aluminium roast pan /
Plaque à rôtir anti-adhésive présentation / Bräter Antihaft Aluminiumpräsentation

ALUMINIO /
ALUMINIUM

REF	cm	H cm	Lts	
P114.540	40 x 30	6,5	6,30	1
P114.545	45 x 32	6,5	7,60	1



**4.2 HORNO Y RUSTIDERAS / OVEN AND ROAST PAN /
FOURET PLAQUE À RÔTIR/ OFEN UND BRATFORMEN**

**BANDEJAS HORNO GASTRONORM /
GASTRONORM SHEET PANS /
PLAQUES FOUR GASTRONORME /
GASTRONORM OFENBLECHE**

Bandeja gastronorm /
Gastronorm sheet /
Plaque gastronorme /
Gastronormtablett

P3180

INOX - ST/STEEL
EDELSTAHL
18/10



Grosor: 1 mm
Thickness: 1 mm
Épaisseur: 1 mm
Dicke: 1 mm

REF	TIPO / TYPE	mm	H mm	
P318.005	1/1	530 x 325	8,0	1

Bandeja honda gastronorm /
Deep gastronorm sheet /
Plaque gastronorme fonde /
Tiefes Gastronormtablett

P3182

INOX - ST/STEEL
EDELSTAHL
18/10



Grosor: 0,8 mm
Thickness: 0,8 mm
Épaisseur: 0,8 mm
Dicke: 0,8 mm

REF	TIPO / TYPE	mm	H mm	
P318.211	1/1	530 x 325	20,0	1

Bandeja GN antiadherente /
Non-stick GN pan tray /
Plaque GN anti-adhésive /
Antihft Tablett GN

P1323

ALUMINIO /
ALUMINIUM



Grosor: 3 mm
Thickness: 3 mm
Épaisseur: 3 mm
Dicke: 3 mm

REF	TIPO / TYPE	H mm	Lts	
P132.365	1/1	65,0	7,90	1

Bandeja multiunidades /
Multi-units tray /
Plaque multi-unités /
Multieinheiten Tablett

P1325

ALUMINIO /
ALUMINIUM

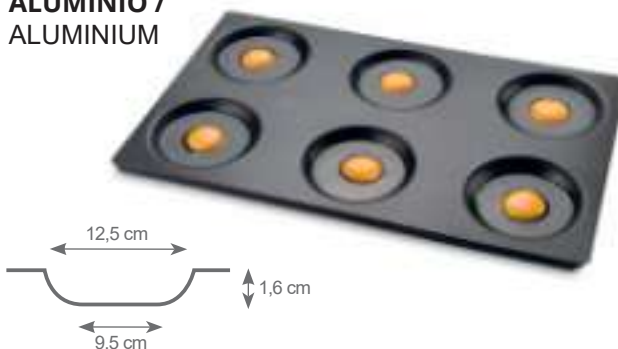

REF	TIPO / TYPE	mm	
P132.560	1/1	530 x 325	1

CUBETAS GASTRONORM / GASTRONORM CONTAINERS / BACS GASTRONORME / GASTRONORM BEHÄLTER

HORNO /
OVEN /
FOUR

Ver productos en / See products on /
Voir produits en page / Siehe produkte in

P.
198



4.3 HORNO Y RUSTIDERAS / OVEN AND ROAST PAN / FOUR ET PLAQUE À RÔTIR/ OFEN UND BRATFORMEN

BANDEJAS PASTELERÍA / PASTRY TRAYS / PLAQUES À PÂTISSERIE / PATISSERIETABLETT



P318 Bandeja pastelería / Baking sheet /
Plaque à pâtisserie / Patisserietablett

INOX - ST/STEEL
EDELSTAHL
18/10



Grosor: 1 mm
Thickness: 1 mm
Épaisseur: 1 mm
Dicke: 1 mm

REF	mm	H mm	
P318.040	400 x 300	12,0	1
P318.060	600 x 400	12,0	1

P779 Bandeja pastelería / Baking sheet /
Plaque à pâtisserie / Patisserietablett

INOX - ST/STEEL
EDELSTAHL
18/10



Grosor: 0,7 mm
Thickness: 0,7 mm
Épaisseur: 0,7 mm
Dicke: 0,7 mm

REF	mm	H mm	
P779.017	255 x 175	10,0	1
P779.021	275 x 210	10,0	1
P779.026	300 x 260	10,0	1
P779.060	600 x 200	10,0	1

P778 Bandeja es cuadrada / Tray for confectionery /
Plaque à pâtisserie / Rechteckiges Backblech

INOX - ST/STEEL
EDELSTAHL
18/10



REF	mm	H mm	
P778.040	400 x 300	10,0	1
P778.048	480 x 310	10,0	1
P778.060	600 x 400	10,0	1

Marcos para bandejas es cuadradas /
Rectangle for bakin sheets /

P777 Rectangle pour plaques /
Rahmen für rechteckige Backbleche

INOX - ST/STEEL
EDELSTAHL
18/10



Marcos adaptables a las bandejas es cuadradas de la ref. P778, P1232 y P1322
Rectangles that are adptable to the baking sheets of ref. P778, P1232 and P1322
Rectangles pour adapter aux plaques inox des réfs. P778, P1232 et P1322
Rahmen geeignet für rechteckige Backbleche Art.Nr. P778, P1232 und P1322

REF	mm	H mm	
P777.540	395 x 295	50,0	1
P777.548	475 x 305	50,0	1
P777.560	595 x 395	50,0	1

Bandeja para pastelería /
Tray for confectionery /
Plaque à pâtisserie /
Patisserietablett

P123

ALUMINIO /
ALUMINIUM



REF	mm	H mm	
P123.040	400 x 300	12,0	1
P123.060	600 x 400	12,0	1

Bandeja perforada para pastelería /
Perforated tray for confectionery /
Plaque à pâtisserie perforée /
Gelochtes Patisserietablett

P1231

ALUMINIO /
ALUMINIUM



REF	mm	H mm	
P123.140	400 x 300	12,0	1
P123.160	600 x 400	12,0	1

Bandeja para pastelería /
Tray for confectionery /
Plaque à pâtisserie /
Patisserietablett

P1232

ALUMINIO /
ALUMINIUM



REF	mm	H mm	
P123.260	600 x 400	12,0	1

Bandeja pastelería antiadherente /
Non-stick tray for confectionery /
Plaque à pâtisserie anti-adhésive /
Antihaft Patisserietablett

P132

ALUMINIO /
ALUMINIUM



REF	mm	H mm	
P132.040	400 x 300	12,0	1
P132.060	600 x 400	12,0	1

Bandeja pastelería antiadherente perforada /
Perforated non-stick tray for confectionery /
Plaque à pâtisserie anti-adhésive perforée /
Antihaft Patisserietablett gelocht

P1321

ALUMINIO /
ALUMINIUM



REF	mm	H mm	
P132.140	400 x 300	12,0	1
P132.160	600 x 400	12,0	1

Bandeja pastelería antiadherente /
Non-stick tray for confectionery /
Plaque à pâtisserie anti-adhésive /
Antihaft Patisserietablett

P1322

ALUMINIO /
ALUMINIUM



REF	mm	H mm	
P132.260	600 x 400	12,0	1

P9091 **Rejilla gastronorm acero inox / St/Steel gastronorm grid /**
Grille acier inoxydable gastronorm / Rostfreier Gastronormrost



REF	TIPO / TYPE	mm	N. Travesaños / N. Cross-bars / N. Traverses / N. Querstäbe	Ø mm Travesaños / Ø mm Cross-bars / Ø mm Traverses / Ø mm Querstäbe	N. Varillas / N. Wires / N. Fils / N. Stäbe	Ø mm Varillas / Ø mm Wires / Ø mm Fils / Ø mm Stäbe	
P909.121	2/1	650 x 530	3	5	32	2	1
P909.111	1/1	530 x 325	2	5	20	2	1

P9093 **Rejilla pastelería acero inox / St/Steel pastry grid /**
Grille pâtisserie acier inoxydable / Rostfreier Pâtisseriesrost



REF	mm	N. Travesaños / N. Cross-bars / N. Traverses / N. Querstäbe	Ø mm Travesaños / Ø mm Cross-bars / Ø mm Traverses / Ø mm Querstäbe	N. Varillas / N. Wires / N. Fils / N. Stäbe	Ø mm Varillas / Ø mm Wires / Ø mm Fils / Ø mm Stäbe	
P909.340	400 x 300	2	5	22	2	1
P909.360	600 x 400	3	5	29	2	1

P9094 **Rejilla pastelería reforzada acero inox / St/Steel reinforced pastry grid /**
Grille pâtisserie acier inoxydable renforcée / Rostfreier Pâtisseriesrostverstärkt



REF	mm	N. Travesaños / N. Cross-bars / N. Traverses / N. Querstäbe	Ø mm Travesaños / Ø mm Cross-bars / Ø mm Traverses / Ø mm Querstäbe	N. Varillas / N. Wires / N. Fils / N. Stäbe	Ø mm Varillas / Ø mm Wires / Ø mm Fils / Ø mm Stäbe	
P909.460	600 x 400	2	6	24	3	1

P9092 **Rejilla gastronorm con rilsan blanco / White rilsan steel gastronorm grid /**
Grille gastronorm en acier et rilsan blanc / Gastronormrost mit weissem Rilsan



oven



REF	TIPO / TYPE	mm	N. Travesaños / N. Cross-bars / N. Traverses / N. Querstäbe	Ø mm Travesaños / Ø mm Cross-bars / Ø mm Traverses / Ø mm Querstäbe	N. Varillas / N. Wires / N. Fils / N. Stäbe	Ø mm Varillas / Ø mm Wires / Ø mm Fils / Ø mm Stäbe	
P909.221	2/1	650 x 530	3	5	22	5	1
P909.211	1/1	530 x 325	2	5	13	5	1

Ver productos en / See products on / Voir produits en page / Siehe produkte in

P.
151

UTENSILIOS PASTELERÍA /
PASTRY UTENSILS /
USTENSILES PÂTISSERIE /
PATISSERIEZUBEHÖR





**BANDEJAS ESPECIALES /
SPECIAL BAKING SHEET /
PLAQUE FOUR SPÉCIALE /
SPEZIALBLECHE**

HORNO /
OVEN /
FOUR

**P152 Rustidera / Roast pan /
Plaqué à rôtir / Bräter**



Aluminio fundición /
Cast aluminium /
Fonte d'aluminium /
AluminiumGuss



*MINI-SIZE



Ideal para presentación
Ideal for food presentation
Idéal pour présentation
Ideal für die Präsentation

REF	Ø cm	H cm	
P152.025*	25 x 20	6,5	1
P152.030	30 x 22	7,0	1
P152.035	35 x 25	7,5	1

**P153025 Parrilla plana con asas /
Hot-plate with handles /
Grill plat avec poignées /
Flache Bratplatte mit Griffen**



Aluminio fundición /
Cast aluminium /
Fonte d'aluminium /
AluminiumGuss



REF	Ø cm	H cm	
P153.025	25 x 25	2,0	1

**P153034 Parrilla plana con asas /
Hot-plate with handles /
Grill plat avec poignées /
Flache Bratplatte mit Griffen**



Aluminio fundición /
Cast aluminium /
Fonte d'aluminium /
AluminiumGuss



REF	Ø cm	H cm	
P153.034	34 x 26	2,5	1

**P153050 Parrilla plana con asas /
Hot-plate with handles /
Grill plat avec poignées /
Flache Bratplatte mit Griffen**



Aluminio fundición /
Cast aluminium /
Fonte d'aluminium /
AluminiumGuss



REF	Ø cm	H cm	
P153.050	50 x 30	2,5	1



FOOD CONTACT
APPROVED

**BANDEJAS HORNO ESPECIALES /
SPECIAL OVEN TRAY /
PLAQUES DE FOUR SPÉCIALES /
SPEZIAL-OFENBLECHE**



9002 Bandeja pastelería / *Baking sheet* / Plaque à pâtisserie / *Pâtisseriesblech*

ALUMINIO /
ALUMINIUM



9002
5223
5303
5220



REF	mm	H mm	
9002	451 x 654	2,5	1
5223	381 x 533	2,5	1
5303	451 x 327	2,5	1
5220	241 x 330	2,5	1
5228	241 x 165	2,5	1

5220 / 5228



Ideal para presentación
Ideal for food presentation
Idéal pour présentation
Ideal für die präsentation

Ver productos en / See products on / Voir produits en page / Siehe produkte in

P.
469

**LLAUNA BANDEJA PRESENTACIÓN /
SHEET PAN PRESENTATION /
PLATEAU PRÉSENTATION /
BLECH PRÄSENTATIONS-TABLETT**



**BANDEJAS PARA PIZZA /
PIZZA BAKING SHEETS /
PLAQUES À PIZZA /
PIZZABLECHE**

**P705 Molde hondo pizza antiadherente / Non-stick deep pizza mould /
Moule haute pizza anti-adhésif / Tiefes Antihaft Pizzablech**



Hierro + antiadherente /
Iron + non-stick /
Fer + antiadhésif /
Eisen + antihafbeschichtet

REF	Ø cm	H cm	
P705.024	24	2,5	6
P705.028	28	2,5	6
P705.032	32	2,5	6

**P736 Molde pizza antiadherente perforado /
Perforated non-stick pizza mould /
Moule à pizza anti-adhésif perforé /
Gelochtes Antihaft Pizzablech**

Ø 8 mm
agujeros / holes /
trous / löcher



REF	Ø cm	H cm	
P736.030	30	1,3	6
P736.034	34	1,3	6

**P929 Base pizza aluminio /
Aluminium pizza pan /
Plaque à pizza aluminium /
Aluminium Pizzablech**



REF	Ø cm	
P929.025	25	1
P929.028	28	1
P929.030	30	1
P929.036	36	1
P929.040	40	1

**P949 Base rejilla aluminio antiadherente para pizza /
Non-stick aluminium pizza screen /
Base maillée aluminium anti-adhésive pour pizza /
Antihaft Pizzagitter Aluminium**



REF	Ø cm	
P949.025	25,5	1
P949.030	30,5	1
P949.035	35,5	1
P949.040	40,0	1

**P963 Base rejilla aluminio para pizza /
Aluminium pizza screen /
Base maillée aluminium pour pizza /
Pizzagitter Aluminium**



REF	Ø cm	
P963.025	25,0	1
P963.030	30,5	1
P963.035	35,5	1
P963.040	40,0	1

4.7 HORNO Y RUSTIDERAS / OVEN AND ROAST PAN / FOUR ET PLAQUE À RÔTIR/ OFEN UND BRATFORMEN

ACCESORIOS HORNO / OVEN ACCESSORIES / ACCESSOIRES FOUR/ OFENACCESSORIES

P833 Tapete de silicona / non-stick silicone mat / Toile de cuisson / Silikonmatte



- 40 °C
 + 260 °C

REF	mm	
P833.001	520 x 315	1
P833.002	585 x 385	1
P833.003	400 x 300	1

P972 Papel siliconado / Siliconized baking release papers / Papier siliconé anti-adhésif / Backpapier aus Silikon



Caja de 500 unidades. Siliconado por las dos caras. Múltiples usos. Gramaje 41 gr/m². Resistente a la grasa. Color blanco.

Set of 500 units both sides siliconized. Multiple uses. Grammage 41 gr/m². Greaseproof. Bleached.

Boîte de 500 unités. Deux faces siliconées. Multiples utilisations. Grammage 41 gr/m². Résistant à la graisse. Couleur blanc.

Kiste mit 500 Stück. Beidseitig mit Silikon. Mehrfacher Gebrauch. Gewicht 41 gr/m². Resistent gegen Fett. Weiss.

REF	mm	UNIDADES/ UNIT	
P972.060	600 x 400	500	1
P972.053	530 x 325	500	1

P6071 Pinza rustidera c/proteccion silicona / Rost pan tong w/silicon protection / Pinzeplaque a/protetion siicone / Bratzange mit Silikonenschutz



NEW!

REF	L cm	
P607.100	18	1

P607 Pinza fuente horno / Roast pan tong / Pincepour plaque à rôtir / Ofenblechzange



REF	L cm	
P607.000	19	1

P948 Pala pizza de aluminio / Aluminium pizza peel / Pelle à enfourner en aluminium / Aluminium Pizzaschaufel



REF	PALA / PEEL / PELLE / SCHAUFEL CM	L cm	
P948.066	31 x 35	66	1
P948.090	31 x 35	90	1
P948.132	31 x 35	132	1



HORNO /
OVEN /
FOUR



**UTENSILIOS DE COCINA /
KITCHEN UTENSILS /
USTENSILES DE CUISINE /
KÜCHENUTENSILIEN**

- 5.1** **UTENSILIOS DE COCINA / KITCHEN UTENSILS /
USTENSILES DE CUISINE / KÜCHENUTENSILIEN** **96**
-
- 5.2** **PROCESADORES MANUALES DE ALIMENTOS /
MANUAL FOOD PROCESSORS /
APPAREILS MANUELS DE TRANSFORMATION DES ALIMENTS /
HANDLICHEN SCHNEIDEMASCHINEN GEEIGNET FÜR** **123**
-
- 5.3** **TABLAS DE CORTE / CUTTING BOARDS /
PLANCHES À DÉCOUPER / SCHNEIDBRETTER** **138**
-
- 5.4** **ELEMENTOS DE MEDIDA / MEASURING UTENSILS /
USTENSILES DE MESURE / MESSUTENSILIEN** **141**
-
- 5.5** **MANOPLA / MITT / GAN / HANDSCHUHE** **145**
-
- 5.6** **ALFOMBRAS CAUCHO / NATURAL RUBBER MATS /
TAPISEN CAOUTCHOUC / KAUSCHUKMATTEN** **145**
-

Cacillo monobloc /
One piece ladle /

P3011 Louche monobloc /
Monoblock Schöpflöffel

Capacidad marcada en el mango /
Capacity marked on the handle /
Capacité marqué à la queue /
Volumenangabe am Griff markiert



REF	Ø cm	L cm	Lts	
P301.165	6,5	31	0,07	12
P301.108	8	32	0,13	12
P301.109	9	33	0,20	12
P301.110	10	37	0,25	6
P301.112	12	42	0,45	6
P301.114	14	43	0,75	6
P301.116	16	45	1,00	6
P301.118	18	48	1,50	6

Cacillo monobloc económico /
Economical one piece ladle /

P3012 Louche monobloc économique /
Monoblock Schöpflöffel ökonomisch

Capacidad marcada en el mango /
Capacity marked on the handle /
Capacité marqué à la queue /
Volumenangabe am Griff markiert



REF	Ø cm	L cm	Lts	
P301.206	6	27	0,05	10
P301.208	8	31	0,12	10
P301.210	10	33	0,25	10
P301.212	12	36	0,42	10
P301.214	14	39	0,75	10
P301.216	16	43	1,20	10

Cacillo para salsas con 2 picos laterales /
One piece sauce ladle with 2 spouts /

P392 Cuillère à sauces monobloc avec 2 becs verseurs /
Schöpflöffel für Sossen mit 2 seitlichen Ausgüssen

Capacidad marcada en el mango /
Capacity marked on the handle /
Capacité marqué à la queue /
Volumenangabe am Griff markiert



REF	Ø cm	L cm	Lts	
P392.065	6,5	31	0,08	10

Cacillo monobloc mango corto /
One piece ladle short handle /

P30326 Louche monobloc manche court /
Monoblock Schöpflöffel kurzer Stiel



Capacidad marcada en el mango /
Capacity marked on the handle /
Capacité marqué à la queue /
Volumenangabe am Griff markiert



REF	Ø cm	L cm	Lts	
P303.265	6,5	22	0,07	10

4980120 **Cacillo monobloc Kool-Touch® / One-Piece ladle Kool-Touch® handle /**
Louche monobloc manche Kool-Touch® / Monoblock Schöpflöffel Kool-Touch® Griffen



REF		Ø cm	L cm	ml	
4980120	Black	4,5	25,0	30	12
4980230	Blue	6,0	25,0	60	12
4980335	Yellow	7,5	32,0	90	12
4980445	Grey	8,5	32,0	120	12
4980655	Green	9,0	31,5	175	12
4980865	Orange	10,0	32,0	235	12

 **82 °C** **Revestimiento mango / Coated handle /**
Revêtement queue / Griffbeschichtung

P3021 **Espumadera monobloc /**
One piece skimmer /
Écumoire monobloc /
Schaumlöffel Monoblock



REF	Ø cm	L cm	
P302.108	8	29	10
P302.110	10	32	10
P302.112	12	35	10
P302.114	14	37	10
P302.116	16	44	5
P302.118	18	44	5
P302.120	20	47	5

P3022 **Espumadera monobloc económica /**
Economical one piece skimmer /
Écumoire monobloc économique /
Schaumlöffel Monoblock ökonomisch

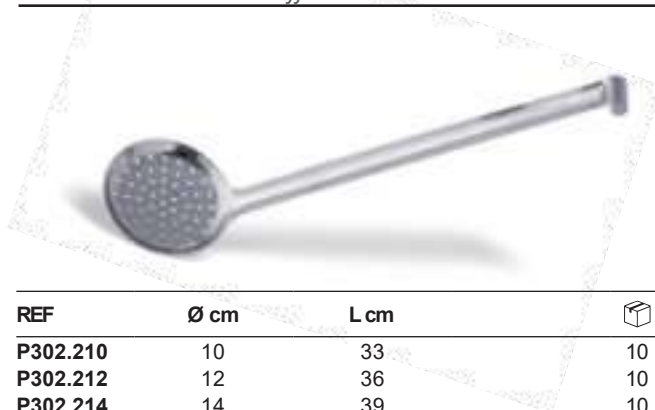

REF	Ø cm	L cm	
P302.210	10	33	10
P302.212	12	36	10
P302.214	14	39	10
P302.216	16	42	10

P3141 **Espátula monobloc sin perforar /**
One piece spatula /
Spatule monobloc /
Pfannenwender Monoblock



REF	Ø cm	L cm	
P314.110	10	36	5
P314.112	12	39	5

P3142 **Espátula monobloc perforada /**
One piece perforated spatula /
Spatule monobloc perforée /
Gelochter Pfannenwender Monoblock



REF	Ø cm	L cm	
P314.210	10	36	5
P314.212	12	39	5

P3143 **Pala pescado monobloc /**
One piece fish spatula /
Pelle à poisson monobloc /
Fischwender Monoblock



REF	cm	L cm	
P314.300	16 x 12	42	5

P315 **Espumadera de alambre /**
Mesh skimmer /
Écumoire à friture /
Drahtschaumlöffel



REF	Ø cm	L cm	
P315.010	10	40	10
P315.012	12	43	10
P315.015	15	50	10
P315.017	17	54	10
P315.020	20	61,5	10

P94101 **Araña / Wire skimmer /**
Araignée / Schaumlöffel



REF	Ø cm	L cm	
P941.013	13	47,5	10
P941.015	15	49,5	10
P941.018	18	52,5	10
P941.020	20	54,5	10
P941.022	22	67,0	5
P941.024	24	69,0	5
P941.028	28	69,0	5

P955 **Espumadera malla fina / Mesh skimmer /**
Écumeire maillée / Feiner Drahtschaumlöffel



Detalle de la malla a escala real
Detail of the sieve at real scale
Détail de la maille à échelle réelle
Detail Maschen in realer Grösse

REF	Ø cm	L cm	
P955.010	10	40	10
P955.012	12	43	10
P955.015	15	50	10
P955.017	17	54	10
P955.020	20	61	10

P394 **Molde nido / Bird nest mould /**
Moule à nid / Vogelnestform

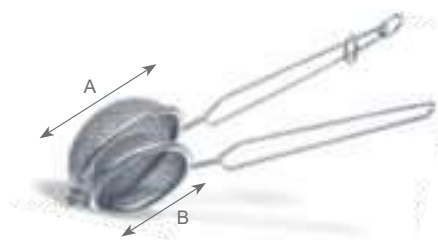

REF	Ø A cm	Ø B cm	
P394.008	10	8	1
P394.012	12	10	1

P376 **Cuchara monobloc profesional /**
Professional one piece spoon /
Cuillère monobloc professionnelle /
Professioneller Löffel Monoblock



REF	Ø cm	
P376.037	37	10

P3761

Cuchara honda monobloc profesional /
Professional one piece deep spoon /
Cuillère profonde monobloc professionnelle /
Tiefer professioneller Löffel Monoblock



REF	Ø cm	
P376.137	37	10

P377

Cuchara perforada monobloc profesional /
Professional one piece perforated spoon /
Cuillère perforée monobloc professionnelle /
Gelochter professioneller Löffel Monoblock



REF	Ø cm	
P377.037	37	10

P3771

Cuchara honda monobloc profesional perforada /
Professional one piece perforated deep spoon /
Cuillère profonde monobloc professionnelle perforée /
Tiefer gelochter professioneller Löffel Monoblock



REF	Ø cm	
P377.137	37	10

P395

Cuchara oblicua monobloc /
One piece crosswire spoon /
Cuillère oblique monobloc /
Sossenlöffel Monoblock



REF	L cm	BASE cm	Lts	
P395.038	38	10 x 7	0,075	10

64130 Cuchara / Solid spoons / Cuillères pleines / Massiv Löffel



232 °C

REF	Color	L cm	
64130		35	12
6414015		35	12
6414030		35	12
6414040		35	12
6414050		35	12
6414070		35	12

64132 Cuchara perforada / Perforated spoons / Cuillères perforées / Perforiert Löffel



232 °C

REF	Color	L cm	
64132		35	12
6414215		35	12
6414230		35	12
6414240		35	12
6414250		35	12
6414270		35	12

P3972 Tenedor monobloc / One piece meat fork / Fourchette monobloc / Fleischgabel Monoblock

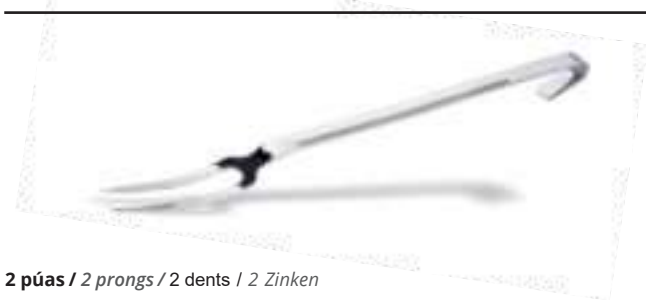

2 púas / 2 prongs / 2 dents / 2 Zinken

REF	Ø cm	
P397.247	47	10

P3973 Tenedor monobloc / One piece meat fork / Fourchette monobloc / Fleischgabel Monoblock



3 púas / 3 prongs / 3 dents / 3 Zinken

REF	L cm	
P397.347	47	10

ANTIMICROBIAL



UTENSILIOS CON PROPIEDADES ANTIMICROBIALES NATURALES /
UTENSILS WITH NATURE'S ANTIMICROBIAL /
USTENSILES AVEC TRAITEMENT ANTIMICROBIEN /
SERVIERUTENSILIEN MIT NATUREIGENEM ANTIMIKROBIOTIKUM

No es difícil imaginar la gran cantidad de microbios y microorganismos que se pueden alojar en los mangos de los utensilios de cocina. Vollrath Pujadas lanza una gama de herramientas que evita que éstos se reproduzcan, gracias a la tecnología AGIO, con iones de plata que retienen las bacterias y evitan su reproducción.

It is not difficult to imagine the large number of microbes and micro-organisms that can live on the handles of kitchen utensils. Vollrath Pujadas has launched a range of tools that prevent them from reproducing, thanks to AGIO technology, with silver ions that hold on to the bacteria and prevent them reproducing.

Il n'est pas difficile d'imaginer le grand nombre de microbes et de microorganismes présents sur les manches des ustensiles de cuisine. Vollrath Pujadas lance une gamme d'ustensiles qui empêchent leur reproduction, grâce à la technologie AGIO, aux ions d'argent qui stoppent les bactéries et empêchent leur reproduction.

Es ist nicht schwer, sich die große Anzahl von Mikroben und Mikroorganismen vorzustellen, die sich auf den Griffen von Küchenutensilien befinden. Vollrath Pujadas bringt eine Palette von Küchenzubehör heraus, das dank der AGIO-Technologie verhindert, dass sich diese Mikroorganismen vermehren. Silberionen neutralisieren Bakterien und verhindern deren Vermehrung.

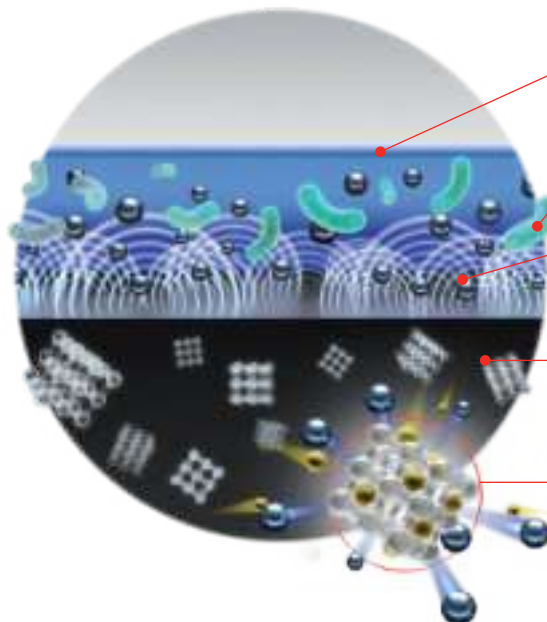

Película superficial de humedad / Surface film of moisture /
Film de surface de l'humidité /
Feuchtigkeitssfilm an der Oberfläche

Bacteria / Bacteria /
Bactéries / Bakterium

Olas de iones de plata anti-microbianos atacando /
Waves of antimicrobial silver ions attacking /
Ondes d'ions argent anti-microbiens attaquant /
Angriffswellen antimikrobieller Silber-Ionen

Material del mango con zeolitas incrustadas /
Handle material with embedded antimicrobial zeolites /
Matériau de manche avec zéolites intégrées /
Griffmaterial mit eingebetteten Zeolithen

Zeolitas liberando iones de plata /
Antimicrobial zeolite releasing silver ions /
Zéolites libérant des ions argent /
Silber-Ionen freisetzende Zeolithe

JP
JACOB'S PRIDE
COLLECTION
GUARANTEED FOR LIFE

SPOODLE®

Capacidad marcada en el mango /
Capacity marked on the handle /
Capacité marqué à la queue /
Volumenangabe am Griff markier.

Mango y porcionadores de acero
inoxidable brillante — resistente
a la corrosión /

Mirror-finished stainless steel
shafts and bowls — resistant to
corrosion /

Tiges et cuillerons en acier
inoxidable ultra-brillant — résistant
à la corrosion /

Stiel und Höhlungen aus hochglanz-
poliertem Edelstahl – gegen Korrosion
beständig.

Mango con diseño ergonómico, de
Nylon que reduce la fatiga durante
su uso. Max. temp. 232 °C /

Handle with ergonomic design, made
from nylon which reduces wear during
use. Maximum temperature 232 °C /

Manche au design ergonomique en
nylon qui réduit la fatigue pendant son
emploi. Temp. Max. 232 °C /

Griff mit Ergonomischem Design aus
Nylon, was den Verschleiß Während der
Nutzung Reduziert. Max. Temp. 232 °C.

COLOR / COLOR / COULEUR / FARBE	ml
Blue	60
Orange	90
Grey	120
Green	175
Red	235

UTENSILIOS /
UTENSILS /
USTENSILES

6433230 Spoodle® monobloc redondo / One-Piece Round Spoodle® / Spoodle® monobloc ronde / Monoblok Rundschaalen Spoodle®



232 °C



REF	Ø cm	L cm	ml	📦
6433230	6,5	32	60	12
6433335	7,4	33	90	12
6433445	8,2	34	120	12
6433655	9,3	35	175	12
6433865	10,2	36	235	12

5284220 Cuchara nylon / Nylon spoon / Cuillère nylon / Nylonlöffel



+ 245 °C

5284220



5284320

REF	Color	L cm	
5284220		34	12
5284320		34	12

4689760 Cuchara nylon para preparación / Nylon spoon for preparation /
 Cuillère nylon pour préparation / Nylonlöffel für die Zubereitung

+ 205°C



REF	Color	L cm	
4689760		21,6	12
4689815		30,5	12
4689830		30,5	12
4689840		30,5	12
4689850		30,5	12
4689860		30,5	12
4689960		38,1	12

47139 Porcionador / Thumb disher / Cuillère de service / Portionierer



REF	Color	Tamaño / Size	Ø mm	Mlts	
47139		6	76	157,7	12
47140		8	73	118,3	12
47141		10	70	96,1	12
47142		12	64	78,9	12
47143		16	57	59,1	12
47144		20	52	48,1	12
47145		24	48	39,4	12
47146		30	44	29,6	12

47390 Porcionador apretable / Squeeze disher / Cuillère-pression de service / Eisportionierer



REF	Color	Tamaño / Size	Ø mm	Mlts	
47390		6	76	139	12
47391		8	73	110	12
47392		10	70	96	12
47393		12	64	84	12
47395		16	57	59	12
47396		20	52	53	12
47397		24	48	45	12
47398		30	44	33	12
47399		36	44	28	12
47403		70	32	14	12

Ver productos en / See products on / Voir produits en page / Siehe produkte in

P.
154

ESPÁTULA SILICONA ALTA TEMPERATURA /
HIGH HEAT SILICONE SPATULA. BOWL SCRAPER /
SPATULE SILICONE HAUTE TEMPÉRATURE /
SILIKONSPACHTEL HOHE TEMPERATUREN



Cacillo /
Ladle /
Louche /
Schöpflöffel

P34001

Nylon



REF	L cm	Lts	
P340.010	28,5	0,08	12

Espumadera /
Skimmer /
Écumoire /
Schaumlöffel

P34002

Nylon



REF	L cm	Ø cm	
P340.020	27	10,7	12

Cuchara de servicio /
Serving spoon /
Cuillère de service /
Servierlöffel

P34003

Nylon



REF	L cm	
P340.030	27,5	12

Espátula /
Turner /
Spatule /
Pfannenwender

P34004

Nylon



REF	L cm	
P340.040	28,5	12

Espátula wok /
Wok spatula /
Spatule wok /
Wokspachtel

P34005

Nylon



REF	L cm	
P340.050	27,5	12

Espátula pastelera /
Baker spatula /
Palette /
Kuchenheber

P34006

Nylon



REF	L cm	
P340.060	29	12

Cuchara espagueti /
Spaghetti server /
Cuillère à spaghetti /
Spaghettilöffel

P34007

Nylon



REF	L cm	
P340.070	29	12

Tenedor /
Meat fork /
Fourchette /
Fleischgabel

P34008

Nylon



REF	L cm	
P340.080	29,5	12

Pinza /
Tong /
Pince /
Zange

P34009

Nylon



REF	L cm	
P340.090	30,5	12

UTENSILIOS /
UTENSILS /
USTENSILES



INOX - ST/STEEL
EDELSTAHL
18/10



Pinzas ideales para emplatar y decorar
Plating tongs for careful lifting, turning and decorating
Pincés idéales pour la présentation et la décoration
Ideale Zangen Zum Anrichten und Dekorieren

P3434 Pinza chef precisión extra larga (fina) / Extra long fine tip straight tweezer (narrow) /
Pince du chef précision extra long (étroite) / Extra lange Präzisionspinzette (schmal)



REF	L cm	
P343.400	30	1

P3436 Pinza chef precisión / Fine tip straight tweezer / Pince du chef précision / Präzisionspinzette



REF	L cm	
P343.600	21	1

P3437 Pinza Chef precisión pequeña / Small fine tip straight tweezer /
Pince du chef précision petite / Kleine Präzisionspinzette



REF	L cm	
P343.700	16	1

P3438 Pinza sushi / Sushi tweezer / Pince à sushi / Sushipinzette



REF	L cm	
P343.800	16	1

Ver productos en / See products on / Voir produits en page / Siehe produkte in

P.
168

ARO REDONDO PARA TARTA /
ICE CREAM CAKE RING /
CERCLEÀ VACHERIN /
RUNDER TORTENRING





P358 INOX Pinza buffet / Utility tong / Pince buffet / Buffetzange



REF	L cm	
P358.024	24,0	12
P358.029	29,5	12
P358.040	40,0	12

P358 COLOR Pinza buffet inox mango color / St. steel utility tong coloured handle /
Pince buffet inox manche couleur / Rostfreie Buffetzange mit farbigem Griff



REF	L cm	Blanco / White / Blanc / Weiss	Rojo / Red / Rouge / Rot	Azul / Blue / Bleu / Blau	Amarillo / Yellow / Jaune / Gelb	Verde / Green / Vert / Grün	Marrón / Brown / Marron / Braun	Negro / Black / Noir / Schwarz	
P358	24	1	2	3	4	5	6	7	1
P358	30	1	2	3	4	5	6	7	1
P358	40	-	-	-	4	-	-	7	1

Ref : P358 + L + Color / Colour / Couleur / Farbe

Fabricadas en acero inoxidable monobloc. Mango con revestimiento PVC aislante para una mejor sujeción /

Made of one piece St/Steel. Handle with PVC coating for a better grip and insulation /

Fabriquéés en acier inoxydable monobloc. Manche avec revêtement PVC pour une meilleure préhension et isolation /

Hergestellt aus rostfreien Monoblock. Griff mit PVC Beschichtung für bessere Griffigkeit und Isolierung.



Fabricadas en acero inox, de una sola pieza, en forma de W que aseguran una máxima resistencia y durabilidad.

Made of a single piece of stainless steel, in a W form to ensure maximum resistance and durability.

Fabriquéés en acier inox, en une seule pièce, en forme de W, garantissant une résistance et une durabilité maximums.

Aus rostfreiem Stahl, einteilig, in W-Form, was maximale Widerstandskraft und Langlebigkeit garantiert.



Forma / Shape /
Forme / Form

4780920 Pinza buffet monobloc Kool-Touch® / One-Piece utility tong Kool-Touch® /
Pince buffet Kool-Touch® / Einteilige, farblich gekennzeichnete Kool-Touch® gewellte Servierzangen



82 °C



Festoneada.
Scalloped.
Festonné.
Gewellt.



Forma / Shape /
Forme / Form

REF	Color	L cm	
4780920	Black	24	12
4781220	Black	30	12
4781620	Black	40	12
4780930	Blue	24	12
4781230	Blue	30	12
4781630	Blue	40	12
4780940	Red	24	12
4781240	Red	30	12
4781640	Red	40	12
4780950	Yellow	24	12
4781250	Yellow	30	12
4781650	Yellow	40	12
4780960	Orange	24	12
4781260	Orange	30	12
4781660	Orange	40	12
4780970	Green	24	12
4781270	Green	30	12
4781670	Green	40	12

4780620 Pinza buffet monobloc Kool-Touch® / One-Piece tong Kool-Touch® /
Pince buffet inox Kool-Touch® / Rostfreie Buffetzange Kool-Touch®

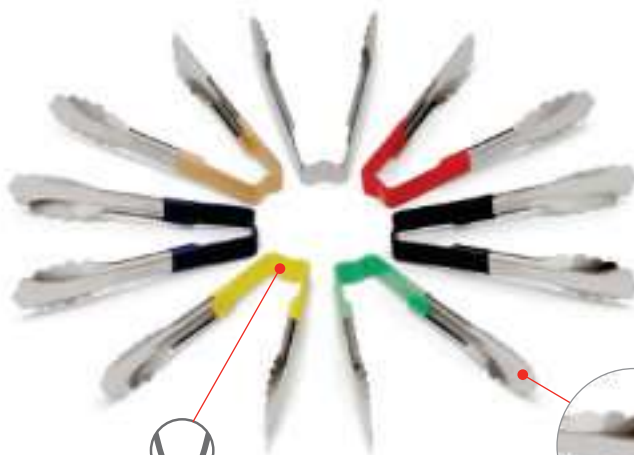

Forma / Shape /
Forme / Form



Festoneada.
Scalloped.
Festonné.
Gewellt.

REF	Color	L cm	
4780620	Black	15	12
4780630	Blue	15	12
4780640	Red	15	12
4780650	Yellow	15	12
4780660	Orange	15	12
4780670	Green	15	12

Pinza más corta para espacios estrechos o comida delicada /
Shorter utility tong for tight spaces or delicate food applications /
Pince utilitaire courte pour espaces restreints ou aliments délicats à manipuler /

Kürzere Universalzange für beengte Platzverhältnisse und das Arbeiten mit delikaten Speisen

4780912 Pinza con extremo de nylon / Utility tong with nylon end /
 Pince utilitaire avec extrémité nylon / Universalzangemit Nylonenden

NSF 232 °C



Festoneada.
 Scalloped.
 Festonné.
 Gewellt.

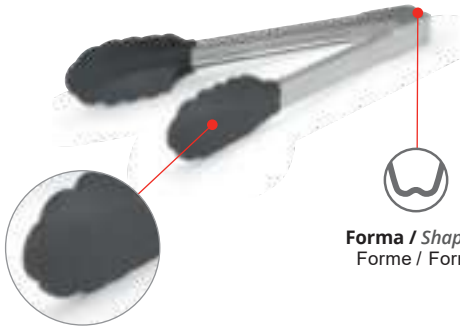

Forma / Shape /
 Forme / Form

Inox + Nylon / St/Steel + Nylon /
 Rostfreier Stahl + Nylon

REF	L cm	
4780912	24	12
4781212	30	12

4780610 Pinza de acero inoxidable / Stainless steel tong / Pince inoxydable / Edelstahl-Servierzange



Festoneada.
 Scalloped.
 Festonné.
 Gewellt.

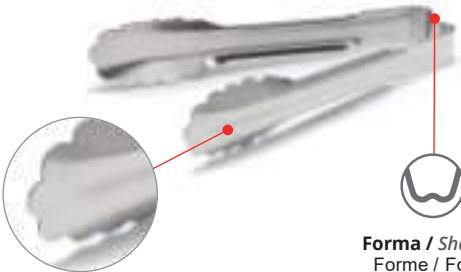

Forma / Shape /
 Forme / Form

* Pinza mas corta para espacios estrechos o comida delicada /
 * Shorter utility tong for tight spaces or delicate food applications /
 * Pince utilitaire courte pour espacesrestreints ou aliments deli-
 cats a manipuler /
 * Kurzere Universalzange fur beengte Platzverhältnisse und das Arbei-
 ten mit delikaten Speisen

REF	L cm	
4780610*	15,2	12
4780910	24,1	12
4781210	30,5	12
4781610	40,6	12

4791210 Pinza VERSAGRIP® de acero inoxidable / VERSAGRIP® Stainless steel tong /
 Pince inox VERSAGRIP®/VERSAGRIP® Edelstahl-Servierzange



Forma / Shape /
 Forme / Form

VERSAGRIP®
 Presenta extremos aplanados y dentados para mayor agarre.
 Features flattened ends and gripper teeth.
 Offre des extrémités aplaties et crantées pour une meilleure prise.
 Mit abgeflachten Enden und gezahntem Greifer.

REF	L cm	
4791210	30,5	12
4791610	40,6	12

47046 Pinza dentada reforzada / Reinforced Pom Tong /
 Pince ceinture renforcée / Verstärkte Gezahnte Zange



47049

INOX - ST/STEEL
EDELSTAHL

Construcción de una sola pieza / One-piece construction /
 Construction monobloc / Einteilige Ausführung



Ideal para hornos, brasa y barbacoa

Ideal for ovens, grills and barbecues

Idéal pour fours, grill et barbecue

Ideal für Öfen, Kohlenfeuer und Grillanlagen

REF	L cm	
47046	15,2	36
47049	22,9	24

47326 Pinza dentada reforzada Kool-Touch® /
Kool-Touch® Reinforced Pom Tong /
Pince ceinture renforcée Kool-Touch® /
Kool-Touch® Verstärkte Gezahnte Zange



82 °C



INOX - ST/STEEL
EDELSTAHL

Construcción de una sola pieza / One-piece construction /
Construction monobloc / Einteilige Ausführung



Ideal para hornos, brasa y barbacoa
Ideal for ovens, grills and barbecues
Idéal pour fours, grill et barbecue
Ideal für Öfen, Kohlenfeuer und Grillanlagen

REF	L cm	
47326	15,2	12

P611 Pinza dentada / Pom tong /
Pince ceinture / Gezahnte Zange



Ideal para hornos, brasa y barbacoa
Ideal for ovens, grills and barbecues
Idéal pour fours, grill et barbecue
Ideal für Öfen, Kohlenfeuer und Grillanlagen

REF	L cm	
P611.001	24	24

47325 Pinza tipo tijeras de uso intensivo / Heavy-Duty scissor tongs /
Pinces type ciseaux à usage intensif / Scherenzange für starke Beanspruchung



REF	Color	L cm	
47325		38	12



P620 Pala chips / Chip bagger /
Pelle à frites / Frittenschaufel



Mano derecha / Right hand
Main droite / Rechtshändig

REF	cm	
P620.001	23 x 21	1

P621 Pala chips ABS / ABS chip bagger /
Pelle à frites en ABS / Frittenschaufel ABS

+ 80 °C



REF	cm	
P621.000	23 x 21	1

5.1 **UTENSILIOS DE COCINA / KITCHEN UTENSILS /**
USTENSILES DE CUISINE / KÜCHENUTENSILIEN

UTENSILIOS DE COCINA / KITCHEN UTENSILS /
USTENSILES DE CUISINE / KÜCHENUTENSILIEN

Espátula lisa, biselada /
Solid, beveled turner with /
Palette pleine, biseautée /
Pfannenwender für schwere
Beanspruchung Griffen massiv abgeschrägt

4808720



232 °C

Ergo Grip®
Mango / Handle / Queue / Griff

Extra resistente /
Heavy duty /
Extra résistant /
Extra-resistant



REF	Color	(L x W) cm	L cm	
4808720		15 x 7,5	34,5	12
4808715		15 x 7,5	34,5	12

Espátula reforzada /
Solid Turner /
Palette renforcée /
Edelstahl-Pfannenwender für schwere
Beanspruchung massiv

4808820



232 °C

Ergo Grip®
Mango / Handle / Queue / Griff

Extra resistente /
Heavy duty /
Extra résistant /
Extra-resistant



REF	Color	(L x W) cm	L cm	
4808820		21 x 7,5	42	12

Espátula perforada reforzada /
Perforated Turner with /
Palette perforée renforcée /
Edelstahl-Pfannenwender für
schwere Beanspruchung perforiert

4808920



232 °C

Ergo Grip®
Mango / Handle / Queue / Griff

Extra resistente /
Heavy duty /
Extra résistant /
Extra-resistant



REF	Color	(L x W) cm	L cm	
4808920		21 x 7,5	42	12

Espátula nylon reforzada /
Slotted reinforced nylon turner /
Spatule renforcée à nylon /
Hochtemperaturbeständiger
Nylon-Pfannenwender,
Geschlitzter Wender

5284120



245 °C Nylon

Extra resistente /
Heavy duty /
Extra résistant /
Extra-resistant



Construcción de una sola pieza /
One-piece construction /
Construction monobloc /
Einteilige Ausführung

REF	Color	L cm	
5284120		34,5	12

P381 Espátula triangular "pintor" /
Cleaning spatula / Palette triangle /
Dreieckige Reinigungsspachtel

Mango ABS / ABS Handle /
Manche en ABS / ABS Griff



REF	cm	L cm	
P381.008	8	24,5	12
P381.010	10	25	12

P382 Pala bar / Spatula / Palette / Spachtel

Mango ABS / ABS Handle /
Manche en ABS / ABS Griff



REF	cm	L cm	
P382.000	7 x 16	29	12

P383 Pala fast-food y pescado /
Fast-food and fish turner /
Palette fast-food et poisson /
Fast-Food und Fischeaufel

Mango ABS / ABS Handle /
Manche en ABS / ABS Griff

Flexible /
Flexibel



REF	cm	L cm	
P383.000	7,3 x 25	38	12

P384 Pala fast-food perforada /
Perforated fast-food turner /
Palette fast-food perforée /
Fast-Food Schaufel gelocht

Mango ABS / ABS Handle /
Manche en ABS / ABS Griff

Flexible /
Flexibel



REF	cm	L cm	
P384.000	7,3 x 25	38	12

P386 Rasqueta / Dough scraper /
Raclette / Schaber

Mango ABS / ABS Handle /
Manche en ABS / ABS Griff



REF	cm	
P386.000	15 x 7,5	12

P380 Ruleta cortapizzas / Pizza wheel /
Roulette à pizza / Pizzaschneider

Mango ABS / ABS Handle /
Manche en ABS / ABS Griff



REF	cm	L cm	
P380.000	10	23,5	12

P385 Espátula pastelera / Baker spatula / Palette / Kuchenspachtel

Mango ABS / ABS Handle /
Manche en ABS / ABS Griff



REF	Pala / Peel / Pelle / Blatt cm	L cm	
P385.020	20,5	34	12
P385.026	26	39	12
P385.030	30	43,5	12

Espátula para untar /
Butter spreader /
Couteau à beurre /
Aufstrichspachtel

P3855



REF	Pala / Peel / Pelle / Blatt cm	L cm	
P385.500	10,4 x 3,4	23	12

Pala pasteles /
Cake server /
Pelle à gâteau /
Keksschaufel

P872

Sin sierra /
Without saw /
Sans scie /
Ohne säge



REF	L cm	
P872.000	28	12

Rasqueta triangular. Mango madera /
Triangle dough scraper. Wood handle /
Raclette triangle. Manche en bois /
Dreieckiger Schaber. Holzgriff

P37501



REF	Pala / Peel / Pelle / Blatt cm	L cm	
P375.010	10,2 x 10	21	12

Pala bar. Mango madera /
Spatula. Wood handle /
Palette. Manche en bois /
Schaufel. Holzgriff

P37506



REF	Pala / Peel / Pelle / Blatt cm	L cm	
P375.061	15,2 x 7,6	29	12

Rasqueta rectangular. Mango madera /
Rectangular dough scraper. Wood handle /
Raclette rectangle. Manche en bois /
Rechteckiger Schaber. Holzgriff

P37507



REF	Pala / Peel / Pelle / Blatt cm	L cm	
P375.070	15,2 x 7,6	11,3	12

Espátula para untar. Mango madera /
Butter spreader. Wood handle /
Couteau à beurre. Manche en bois /
Aufstrichspachtel. Holzgriff

P37511



REF	Pala / Peel / Pelle / Blatt cm	L cm	
P375.110	10,2 x 3,3	19,7	12

GUÍA SELECCIÓN RALLADORES / GRATERS SELECTION GUIDE / GUIDE SÉLECTION RAPÊS/AUSWAHLÜBERSICHT REIBEN

	DOBLE NAVAJA / RIBON / TRANCHANTS/ DOPPELKLINGEN	TIRAS LARGAS / LARGE SHAVER / LARGE COUPE / LANGE STREIFEN	FINO / FINE / FIN / FEIN	MEDIO / MEDIUM / MOYEN / MITTEL	GRUESO / EXTRA COARSE / GROS GRAINS / GROB	DUAL / DUAL / DOUBLE / DOPPEL
 Zanahoria / Carrot / Carotte / Karotten	✓	✓				✓
 Cebolla / Onion / Oignon / Zwiebel	✓			✓		✓
 Ajo / Garlic / Ail / Knoblauch			✓			
 Chocolate Schokolade	✓		✓	✓	✓	✓
 Citricos / Citrus / Citron / Zitronen		✓	✓	✓		
 Patata / Potato / Pomme de Terre / Kartoffel	✓	✓				
 Manzana / Apple / Pomme / Apfel	✓	✓			✓	
 Queso duro / Hard Cheese / Fromage / Hartkäse	✓		✓	✓	✓	✓
 Queso blando / Soft Cheese / Fromage / Weichkäse	✓				✓	
 Nuez / Nut / Noix / Nüsse			✓	✓		✓
 Pimiento / Pepper / Poivron / Pfeffer			✓	✓		✓
 Tomate / Tomato / Tomato / Tomaten				✓	✓	

UTENSILIOS /
UTENSILS /
USTENSILES

P328 Rallador / Grater / Râpe / Reibe

INOX - ST/STEEL
ROSTFREIER TAHL



Ref. P328.600

REF	Caras / Sides / Faces / Seiten	cm	H cm	
P328.020	4	9 x 6,5	20,8	12
P328.023	4	10,5 x 8	23,3	12
P328.600	6	14,5 x 11	22,0	12

P391 Rallador nuez moscada de acero inox / St/Steel nutmeg grater /
Râpe à muscade en acier inox / Rostfreie Muskatnussreibe



REF	
P391.000	12

P3221 Rallador acero inoxidable "slim" con mango / *St/Steel "slim" grater with handle /*
 Râpe inoxydable "slim" avec queue / *Rostfreie Reibe "schmal" mit Griff*

Ralladores de acero inoxidable. Mangos ergonómicos. Borde antideslizante
St/Steel graters. Ergonomic and soft touch handles. Non-slip rubber end
Râpesen acier inoxydable. Poignée ergonomique. Extrémité anti-dérapant
Rostfreie Reiben. Ergonomische Griffe. Antirutschrand.

REF	cm	
P322.101	39,5 x 3,5	1
P322.102	39,5 x 3,5	1
P322.103	39,5 x 3,5	1
P322.104	39,5 x 3,5	1



Especial cítricos /
Ideal for citrus /
Idéal pour agrumes /
Ideal für Zitrusfrüchte



REF. P322.104
Fino / Fine /
Fin / Fein



REF. P322.101
Dual / Dual /
Double / Doppel



REF. P322.103
Medio / Medium /
Moyen / Medium



REF. P322.102
Doble navaja / Ribon /
Tranchants / Zwei Klängen

P3222 Rallador acero inoxidable "wide" con mango / *St/Steel "wide" grater with handle /*
 Râpe inoxydable "wide" avec queue / *Rostfreie Reibe "breit" mit Griff*

Ralladores de acero inoxidable. Mangos ergonómicos. Borde antideslizante
St/Steel graters. Ergonomic and soft touch handles. Non-slip rubber end
Râpesen acier inoxydable. Poignée ergonomique. Extrémité anti-dérapant
Rostfreie Reiben. Ergonomische Griffe. Antirutschrand.

REF	cm	
P322.201	31,5 x 7,3	1
P322.202	31,5 x 7,3	1
P322.203	31,5 x 7,3	1
P322.204	31,5 x 7,3	1



Especial cítricos /
Ideal for citrus /
Idéal pour agrumes /
Ideal für Zitrusfrüchte



REF. P322.204
Fino / Fine /
Fin / Fein



REF. P322.201
Tiras largas / Large shaver /
Large coupe / Lange Streifen



REF. P322.202
Doble navaja / Ribon
Tranchants / Zwei Klängen



REF. P322.203
Grueso / Extra coarse /
Gros grains / Grob

Colador doble malla en acero inoxidable /
St/Steel double mesh strainer /
Passoire double maille en acier inox /
P374 *Doppelmaschiges Sieb rostfrei*



REF	Ø cm	L cm	Luz de malla / Mesh size / Maillage / Maschenweite	📦
			mm	
P374.013	13	30	1-3	72
P374.015	15	32	1-3	72
P374.018	18	34	1-3	72
P374.020	20	38	1-3	72
P374.026	26	58,5	1,6-3	72

Colador 1/2 bola reforzado en acero inox /
St/Steel reinforced 1/2 ball colander /
Passoire ronde renforcé en acier inox /
P324 *Halbkugeliges Sieb rostfrei und verstärkt*

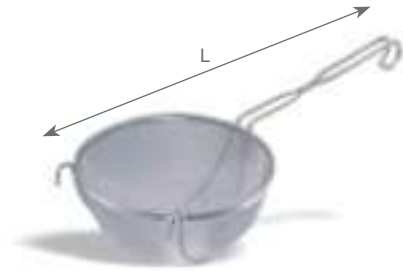

REF	Ø cm	L cm	Luz de malla / Mesh size / Maillage / Maschenweite	📦
			mm	
P324.013	13	36	0,530	12
P324.016	16	40	0,530	12
P324.019	19	42,5	0,530	12
P324.022	22	49	0,530	12
P324.025	25	55,5	0,530	12

Colador media bola en acero inox /
St/Steel hemispherical strainer /
Passoire demi-sphérique en acier inox /
P325 *Halbrundes Sieb rostfrei*



REF	Ø cm	L cm	Luz de malla / Mesh size / Maillage / Maschenweite	📦
			mm	
P325.008	8	22,5	0,700	96
P325.010	10	25,2	0,700	96
P325.012	12	32,5	0,700	96
P325.015	15	40,2	0,700	72
P325.018	18	42,5	0,700	72
P325.020	20	44,5	0,700	72

Colador doble malla en acero inoxidable. Reforzado /
St/Steel double mesh strainer. Reinforced /
Passoire double maille en acier inox. Renforcé /
P375 *Doppelmaschiges Sieb rostfrei und verstärkt*

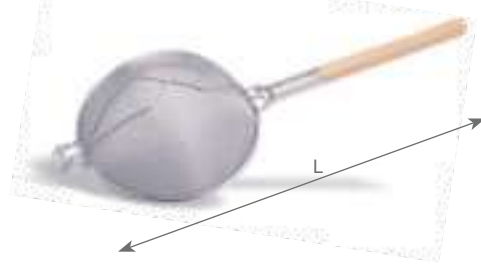

REF	Ø cm	L cm	Luz de malla / Mesh size / Maillage / Maschenweite	📦
			mm	
P375.030	30	79,0	1,040	1
P375.035	35	86,5	1,040	1

Colador cónico en acero inoxidable /
St/Steel conical strainer /
Passoire conique en acier inox /
P348 *Konisches Sieb rostfrei und verstärkt*



REF	Ø cm	L cm	Luz de malla / Mesh size / Maillage / Maschenweite	📦
			mm	
P348.008	8	22,5	0,700	96
P348.010	10	24,5	0,700	96
P348.012	12	31,5	0,700	96
P348.015	15	35	0,700	96
P348.018	18	40,5	0,700	72

Colador bayeta / Cotton strainer /
Passe-bouillon / Textilsieb

Acero inoxidable y algodón
St/Steel and cotton
Acier inoxydable et cotton
Rostfrei und Baumwolle



REF	L cm	📦
P373.020	20	6
P373.024	24	6
P373.028	28	6

P303 Colador chino / *Conical colander* /
Chinois / *Spitzsieb*



REF	Ø cm	H cm	
P303.016	17,2	15,9	12
P303.018	18,6	17,9	12
P303.020	21,1	20,6	12
P303.022	23,2	23,0	12
P303.024	25,1	25,2	12
P303.026	27,2	28,1	12

P347 Colador chino con malla /
Conical colander with wire gauze /
Chinois à gaze /
Spitzsieb mit Maschen



REF	Ø cm	Luz de malla / <i>Mesh size / Mailage / Maschenweite</i>	
		mm	
P347.020	20	0,700	12
P347.024	24	0,700	12

P970 Soporte para chino o embudo /
Stand for chinese colander or funnel /
Support pour chinois ou entonnoir /
Ständer für Spitzsieb und Trichter



REF	Ø cm	H cm	
P970.000	16	19	1

P3032 Triángulo / *Triangle* /
Triangle / *Dreieck*

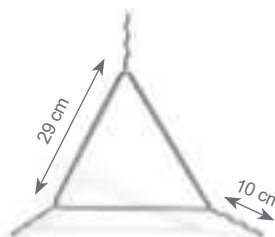

Triángulo equilátero
Equilateral triangle
Triangle équilatéral
Gleichseitiges Dreieck

REF	L cm	
P303.200	29	1

Ver productos en / *See products on* / Voir produits en page / *Siehe produkte in*

P.
161

EMBUDO DOSIFICADOR /
CONFECTIONERY FUNNEL /
ENTONNOIR DOSEUR /
DOSIERUNGSTRICHTER



P308 Escurridera / Conical colander / Passoire conique / Konischer Seiher

INOX - ST/STEEL
EDELSTAHL
18/10



EXTRA RESISTENTE /
HEAVY DUTY /
EXTRA RÉSISTANT /
EXTRA-RESISTENT

REF	Ø cm	H cm	
P308.030	30	16,0	1
P308.035	35	16,5	1
P308.040	40	18,0	1
P308.045	45	19,5	1
P308.050	50	22,5	1

P109 Escurridera con aro / Conical colander / Passoire conique / Konischer Seiher mit Ring

ALUMINIO /
ALUMINIUM



REF	Ø cm	H cm	
P109.035	35	16,5	1
P109.040	40	17,5	1
P109.045	45	20,0	1
P109.050	50	22,5	1

P300 Escurridera inox con base / St/steel colander with stand /
Passoire inox sur pied / Seiher rostfrei mit Ständer

INOX - ST/STEEL
ROSTFREIER STAHL



REF	Ø cm	H cm	
P300.024	24	11,50	1
P300.030	30	13,50	1

P3003 Escurridera de malla / Mesh conical colander / Passoire à maille / Maschensieb

INOX - ST/STEEL
ROSTFREIER STAHL



REF	Ø cm	H cm	
P300.325	25	12	1
P300.335	35	18	1
P300.340	40	18	1

P313 Pasapurés / Vegetable sieve /
 Moulin à légumes / Passiermaschine



Con 2 discos inox. intercambiables /
 With 2 St/Steel interchangeable cutters /
 Avec 2 coupoirs inox interchangeables /
 Mit 2 auswechselbaren Scheiben rostfrei

REF	Ø cm	Ø cm Filtro / Filter / Filtre / Filter	☐
P313.025	25	11,5	1
P313.030	30	14,5	1

P3131 Pasapurés / Vegetable sieve /
 Moulin à légumes / Passiermaschine



Con 2 discos inox. intercambiables /
 With 2 St/Steel interchangeable cutters /
 Avec 2 coupoirs inox interchangeables /
 Mit 2 auswechselbaren Scheiben rostfrei

REF	Ø cm	Ø cm Filtro / Filter / Filtre / Filter	☐
P313.126	26	16,5	1
P313.132	32	16,5	1

P945 Harinero / Flour bin /
 Tamis à farine / Mehlsieb



REF	cm	☐
P945.037	37 x 26,5 x 18	1
P945.050	50 x 26,5 x 18	1
P945.051	50 x 33 x 18	1

P3135 Pasapurés / Potato ricer /
 Presse-purés / Kartoffelpresse



REF	Ø cm	L cm	☐
P313.500	9	30,5	1

P958 Gancho acero inoxidable 1p. /
 St/Steel hook 1p. / Crochet inox 1p. /
 Haken rostfrei 1 St.



Precio caja 10 unidades
 Price 10 units box
 Prix colis 10 unités
 Preis Kiste 10 Teile

REF	L cm	Ø mm	☐
P958.010	10	4	10
P958.012	12	5	10
P958.014	14	6	10
P958.016	16	6	10
P958.018	18	6	10

P954 Embudo con filtro extraíble /
 Funnel with removable filter /
 Entonnoir avec filtre extractible /
 Trichter mit herausnehmbarem Filter



REF	Ø A cm	H B cm	☐
P954.013	13	2,6	1
P954.015	15	2,6	1
P954.020	20	3,2	1
P954.025	25	3,2	1

P868 Dispensador a presión / Squeeze dispenser / Distributeur à pression / Einzeldosierer



REF	COLOR	ml	H cm	Ø cm	
P868.001	● ●	240	18,0	5	12
P868.002	● ●	360	21,0	5	12
P868.003	● ●	720	24,5	5	12
P868.004	● ●	240	18,0	5	12
P868.005	● ●	360	21,0	5	12
P868.006	● ●	720	24,5	5	12
P868.007*	○ ○	240	18,0	5	12
P868.008*	○ ○	360	21,0	5	12
P868.009*	○ ○	720	24,5	5	12

* Transparente / Clear / Transparent

2808-13 Dispensador a presión / Squeeze dispenser / Distributeur à pression / Einzeldosierer



2808-13
2812-13

4916-13
4924-13
4932-13

REF	COLOR	ml	H cm	Ø cm	
2808-13	○ ○	240	18,4	5,0	12
2812-13	○ ○	350	18,4	6,0	12
4916-13	○ ○	470	18,7	7,5	12
4924-13	○ ○	710	26,0	7,3	12
4932-13	○ ○	950	26,4	8,3	12

Transparente / Clear / Transparent

2208-1354 Dispensador a presión doble / Twin squeeze dispenser / Distributeur à pression double / Zweifachdosierer



REF	COLOR	ml	H cm	Ø cm	
2208-1354	○ ●	200	18,0	5	12

Transparente / Clear / Transparent

IDEA! Ideal para decoración
Ideal for dish presentation
Idéal pour decoration
Ideal für die Dekorierung



3316-13191 Dispensador a presión triple / Tri squeeze dispenser / Distributeur à pression triple / Dreifachdosierer



REF	COLOR	ml	H cm	Ø cm	
3316-13	○ ○	470	18,7	7,5	12
3332-13	○ ○	950	25,4	8,6	12
3316-13191	○ ●	500	18,0	5	12

Transparente / Clear / Transparent

IDEA! Ideal para decoración
Ideal for dish presentation
Idéal pour decoration
Ideal für die Dekorierung



3316-13191

3316-13
3332-13

2908 Dispensador a presión con tapón cierre rosca / Squeeze dispenser with open-close system cap /
Distributeur pressurisation a/capuchon d'ouverture-fermeture / Druckdosierermit Schraubdeckel



Ref. 2908-13

Ref. 5324-13

REF	ml	H cm	Ø cm	
2908-13	240	18,4	5,1	1
2912-13	350	18,4	6,0	1
5324-13	710	24,4	7,3	1

Transparente / Clear / Transparent



26120 Dispensador a presión con tapón / Squeeze dispenser with cap /
Distributeur pression avec capuchon / Druckdosierermit Deckel



Ref. 26120-13

Ref. 26240-13

Ref. 26320-13

REF	ml	H cm	Ø cm	
26120-13	350	16,2	6,2	1
26240-13	710	22,5	7,5	1
26320-13	950	22,9	8,6	1

Transparente / Clear / Transparent



4961 Especieros / Dredgers / Saupoudreuses / Streuer



Ref. 4961-13191

Ref. 4961-1332

Ref. 4961-1308

Ref. 4961-1301

REF	ml	Ø cm Agujeros / Holes / Trous / Löcher	Ø cm	H cm	
4961-13191	470	0,14	7,3	16	1
4961-1332	470	0,25	7,3	16	1
4961-1308	470	0,46	7,3	16	1
4961-1301	470	0,94	7,3	16	1

Transparente / Clear / Transparent

P946 Especieros / Dredgers / Saupoudreuses / Streuer



A

B

C

D

REF	Ø cm	H cm	Ø mm	
A P946.001	7	9,6	-	12
B P946.002	7	9,6	2	12
C P946.003	7	9,6	3	12
D P946.004	7	9,6	4	12

Especiero "A" con malla
Dredger "A" with mesh
Saupoudreuse "A" maillée
Streuer "A" mit Maschen

Con tapón de plástico
With plastic cover
Avec couvercle en plastique
Mit Plastideckel



UTENSILIOS /
UTENSILS /
USTENSILES

Molde huevo sandwich redondo /
Round egg ring /
Moule à oeuf rond /
Runde Sandwicheierform

P870



REF	Ø cm	H cm	
P870.000	8,5	11,0	1

Molde huevo sandwich cuadrado /
Squared egg mould /
Moule à oeuf carré /
Rechteckige Spiegeleierform

P871



REF	cm	H cm	
P871.000	8,5 x 8,5	11,0	1

Aplastacarnes inox forjado /
Solid St/Steel meat beater /
Aplatisseur inox forgé /
Solider Fleischstampfer rostfrei

P905



REF	Ø cm	Kg	L cm	
P905.015	10	1,5	14	1

Aplastadora carne /
Meat tenderizer /
Aplatisseur à viande /
Fleischstampfer

P942 / P943



REF	Ø cm	Kg	L cm	
P942.000	9,5	0,750	28,5	1
P943.000	9,5	0,750	28,5	1

P334

Alcuza / Oil pourer / Huilière / Ölkanne



REF	Lts	
P334.050	0,50	1
P334.100	1,00	1

P94009

Remo acero inoxidable / St/Steel mixing paddle /
 Spatule géante inoxydable / Rührpaddel rostfrei



REF	Pala / Peel / Pelle / Blatt cm	L cm	
P940.090	12 x 19	90	1
P940.120	16 x 19,5	120	1

P873

Barra de notas de aluminio /
 Aluminium check minder /
 Barre porte-bons en aluminium /
 Aluminiumleiste für Notizen



REF	L cm	H cm	
P873.045	45	5,0	1
P873.060	60	5,0	1
P873.090	90	5,0	1

P940

Rascador con mango aluminio /
 Grill scraper aluminium /
 Raclette à plancha /
 Schaber mit Aluminiumgriff



REF	cm	
P940.000	44,5 x 12 x 12,7	1
RE940.001	12,7 x 7,7	1

P8180

Cepillo metálico / Metallic brush /
 Brosse métallique / Metallbürste



Ideal para hornos, brasa y barbacoa
 Ideal for ovens, grills and barbecues
 Idéal pour fours, grill et barbecue
 Ideal für Öfen, Kohlenfeuer und Grillanlagen

REF	L cm	
P818.000	27	1

P944

Escamador / Fish scaler /
 Ecailleur / Fischentschupper



REF	L cm	
P944.000	23,5	1

REDCO® PUJADAS®

AMPLIA GAMA DE PROCESADORES DE ALIMENTOS MANUALES

Corta verduras y frutas
Hasta 11 veces más rápido que el corte a mano
Fácil intercambio de las cuchillas
Limpieza rápida y fácil

WIDE RANGE OF MANUAL FOOD PROCESSORS

Cuts both fruit and vegetables
Speed up your work 11 times faster than hand cutting
Easy-to-remove interchangeable blades
Easy to clean

LARGE GAMME D'APPAREILS MANUELS DE TRANSFORMATION DES ALIMENTS

Coupe les légumes et les fruits
Jusqu'à 11 fois plus rapide que lorsque vous coupez à la main
Couteaux facilement interchangeables
Nettoyage rapide et facile

GROSSE AUSWAHL AN HANDLICHEN SCHNEIDEMASCHINEN

Geeignet für Obst und Gemüse
11 Mal schneller als Handschneiden
Mühelose Austauschbarkeit der Klingen
Schnelle und einfache Reinigung

DADOS Y BASTONCILLOS /
DICE & STICKS /
CUBES ET BÂTONNETS /
WÜRFEL UND STÄBCHEN



REBANADA /
SLICE /
TRANCHES /
SCHEIB



GAJOS /
WEDGE /
QUARTIERS /
ZERTEILER



SACACORAZONES /
CORE /
ÉVIDOIR /
ENTKERNER





UTENSILIOS /
UTENSILS /
USTENSILES

5.2 UTENSILIOS DE COCINA / *KITCHEN UTENSILS* /
USTENSILES DE CUISINE / *KÜCHENUTENSILIEN*

PROCESADORES MANUALES DE ALIMENTOS /
MANUAL FOOD PROCESSORS /
APPAREILS MANUELS DE TRANSFORMATION DES ALIMENTS /
MANUELLE KÜCHENMASCHINEN



* VELOCIDADES / *SPEEDS* /
VITESSES / *GESCHWINDIGKEITEN*

	3x	3x	5x
 Limones / Lemons Citrons / Zitronen			
 Limas / Limes Citrons verts / Limonen			
 Naranjas / Oranges Oranges / Orangen			
 Tomates / Tomatoes Tomates / Tomaten	✓	✓	
 Cebollas / Onions Oignons / Zwiebeln	✓	✓	✓
 Apio / Celery Céleri / Stangensellerie	✓	✓	
 Pimientos / Peppers Poivrons / Paprikaschoten	✓	✓	
 Patatas / Potatoes Pommes de terre / Kartoffeln	✓	✓	
 Manzanas / Apples Pommes / Äpfel	✓ 4x	✓ 4x	
 Peras / Pears Poires / Birnen	✓ 4x	✓ 4x	
 Lechuga / Lettuce Laitue / Kopfsalat			✓
 Pimientos / Bell peppers Poivrons / Paprikaschoten	✓		✓
 Pepino / Cucumbers Concombres / Gurken			✓

* **Veces más rápido que cortar a mano.**
Faster than cutting by hand.
Fois plus rapide qu'une coupe à la main.
Schneller als das Schneiden von Hand.

Reduzca el tiempo de mano de obra /
Reduce labor time /
Réduisez le temps de travail /
Reduzieren Sie Ihre Arbeitszeit



11x	2,5x	3x	3x	5x
	✓	✓	✓	
	✓	✓	✓	
	✓	✓	✓	
		✓	✓	✓
	✓			
	✓	✓	✓	
		✓	✓	
		✓	✓	
✓				

UTENSILIOS /
 UTENSILS /
 USTENSILES



55457 Cortador-Rebanador de sobremesa grande / Big size tabletop dicer & slicer /
Grand Coupe légumes en tranches et cubes / Größer Tisch Würfelschneider und -hobel für Arbeitsflächen



InstaCut™ 5.0

Sobremesa /
Tabletop /
À poser /
Arbeitsflächen

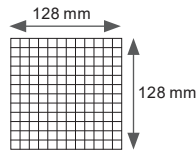

Adaptable a / Adjustable to /
Adaptable à / geeignet für

Dentro / Inside /
Dans / Innerhalb (max)
1/3 100 mm
1/4 150 mm
1/6 150 mm

Fuera / Outside /
Extérieur / Außerhalb (max)
1/1 200 mm

Con ventosas de agarre en la base.
With suction base.
Avec ventouse d'accrochement à la base.
Mit Saugfüßen.

REF	TIPO / TYPE	CORTE / CUT COUPE / SCHNITT mm	
DADOS - BASTONCILLOS / DICE & STICKS / CUBESETBÄTONNETS/ WÜRFEL UND STÄBCHEN			
55457		6,4 ●	1
55458		9,5	1
55459		12,7	1
REBANADA / SLICE / TRANCHES / SCHEIB			
55460		6,4 ●	1

Los artículos marcados con cada punto de color son compatibles entre ellos /
Items marked with the same coloured dot are compatible with each other /
Les articles marqués d'un point de couleur sont compatibles /
Die mit den einzelnen Farbpunkten gekennzeichneten Artikel sind miteinander kombinierbar.



*H 50,8 cm Abierto / Open / Ouvert / Offen
*H 47 cm Cerrado / Closed / Fermé / Geschlossen

3X Más rápido / Faster



4X Más rápido / Faster



UTENSILIOS /
UTENSILS /
USTENSILES

Asa en T, bloque de empuje y cuchilla /
T-handle, pusher block and blade /
Poignée en T, bloc de poussée et lame /
T-griff, druckblock und messer

TIPO / TYPE

REF mm

DADOS - BASTONCILLOS / DICE & STICKS / CUBESETBÄTONNETS/ WÜRFEL UND STÄBCHEN

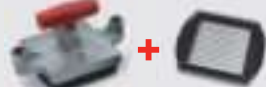

● 55483 6,4
55484 9,5
55485 12,7

REBANADA / SLICE / TRANCHES / SCHEIB



● 55486 6,4

SECCIONES / SECTION / QUARTIERS / STÜCK

GAJOS / WEDGE / QUARTIERS / ZERTEILER



● 55490 6
55491 8
55492 10
● 55493 12

SACACORAZONES / CORE / ÉVIDOIR / ENTKERNER



● 55494 6
55495 8

Sólo cuchilla de reemplazo /
Replacement blade only /
Lame de rechange seule /
Nur ersatzmesser

REF



● 55470
55471
● 55472



● 55473



● 55477
55478
55479
● 55480



● 55481
55482

15000 **Cortador-Rebanador de sobremesa pequeño / Small size tabletop dicer & slicer /**
Coupe légumes en tranches et cubes de table / Kleiner Tisch Würfelschneider und - hobel für Arbeitsflächen



InstaCut™ 3.5

Sobremesa /
Tabletop /
À poser /
Arbeitsflächen

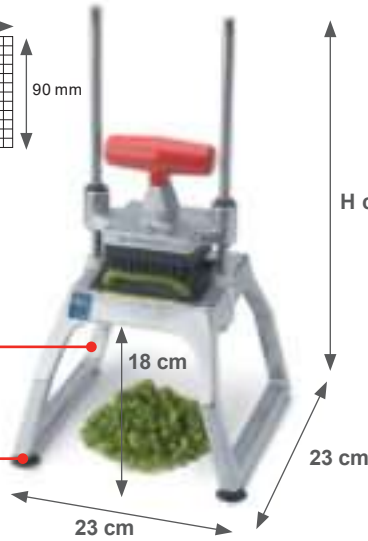
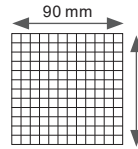

Adaptable a / Adjustable to /
Adaptable à / geeignet für

Dentro / Inside / Dans / Innerhalb (max)
1/3 40 mm
1/4 65 mm
1/6 65 mm

Fuera / Outside /
Extérieur / Außerhalb (max)
1/1 200 mm

Con ventosas de agarre en la base.
With suction base.
Avec ventouse d'accrochement à la base.
Mit Saugfüßen.

REF	TIPO / TYPE	CORTE / CUT COUPE/ SCHNITT mm	
DADOS - BASTONCILLOS / DICE & STICKS / CUBESETBÄTONNETS/ WÜRFEL UND STÄBCHEN			
15000		6,4	1
15001		9,5	1
15002		12,7	1

REF	TIPO / TYPE	SECCIONES / SECTION / QUARTIERS/ STÜCK	
GAJOS / WEDGE / QUARTIERS/ ZERTEILER			
15005		6	1
15006		8	1
15007		10	1

*H 45,7 cm **Abierto / Open / Ouvert / Offen**
 *H 43,5 cm **Cerrado / Closed / Fermé / Geschlossen**

3X Más rápido / Faster



4X Más rápido / Faster



15016 **Cortador-Rebanador de pared / Wall mount dicer & slicer /**
Coupe légumes fixation murale / Tischwürfelschneider und - hobel zur Wandmontage



InstaCut™ 3.5

Pared /
Wall mount /
Fixation murale /
Wandmontage



REF	TIPO / TYPE	CORTE / CUT COUPE/ SCHNITT mm	
DADOS - BASTONCILLOS / DICE & STICKS / CUBESETBÄTONNETS/ WÜRFEL UND STÄBCHEN			
15016		6,4	1
15017		9,5	1

Asa en T, bloque de empuje y cuchilla / T-handle, pusher block and blade /
Poignée en T, bloc de poussée et lame / T-griff, druckblock und messer

Ref. 15000 - 15010

TIPO / TYPE	REF	mm
DADOS - BASTONCILLOS / DICE & STICKS / CUBESETBÄTONNETS/ WÜRFEL UND STÄBCHEN		
	15059	6,4
	15060	9,5
	15061	12,7
	15085	6,4 x 12,7

SECCIONES / SECTION / QUARTIERS/ STÜCK

GAJOS / WEDGE / QUARTIERS/ ZERTEILER	REF	mm
	15050	4
	15052	6
	15053	8
	15054	10
	15055	12

SACACORAZONES / CORE / ÉVIDOIR/ ENTKERNER

TIPO / TYPE	REF	mm
	15058	8

Ref. 15016 - 15024

REF
15081
15082
15083
-
15073
-
15076
-
15078

Sólo cuchilla de reemplazo /
Replacement blade only /
Lame de rechange seule /
Nur ersatzmesser

REF
15062
15063
15064
15086
15065
15067
15068
15069
15070

REF
15072

47713 Cortador de patatas / Potato cutter / Coupe-pommes de terre / Pommes-Frites-Schneider

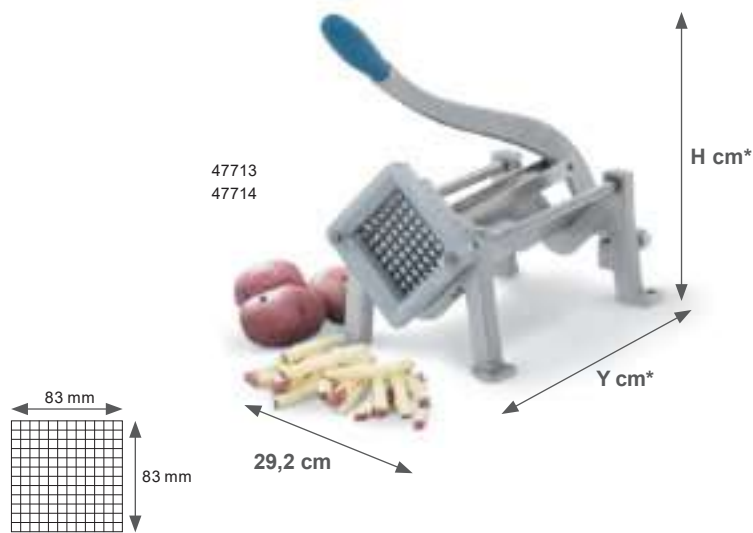

47713
47714

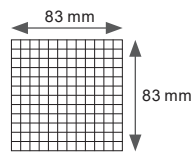

45682
**No se incluyen los tornillos.
Screws not included.
Vis non fournies.
Schrauben nicht inbegriffen.

30 x 21,5 cm

REF	TIPO / TYPE	CORTE / CUT COUPE/ SCHNITT mm	
DADOS - BASTONCILLOS / DICE & STICKS / CUBESETBÄTONNETS/ WÜRFEL UND STÄBCHEN			
47713		9,5	1
47714		11	1
*Y 87,6 cm H 58,4 cm		Abierto / Open / Ouvert / Offen	
*Y 45,0 cm H 35,6 cm		Cerrado / Closed / Fermé / Geschlossen	

Sólo cuchilla de reemplazo / Replacement blade only / Lame de rechange seule / Nur ersatzmesser

REF	TIPO / TYPE	CORTE / CUT COUPE/ SCHNITT mm	
DADOS - BASTONCILLOS / DICE & STICKS / CUBESETBÄTONNETS/ WÜRFEL UND STÄBCHEN			
45749-1		9,5	1
45750-1		11	1

Agujeros para tornillos en la base de las patas para el montaje permanente en mesas o paredes. Screw holes on base of legs for permanent mounting to table or wall. Trous à vis sur la base des pieds pour fixation permanente sur une table ou un mur. Schraubenlöcher im Boden der Standfüße zur dauerhaften Befestigung an Tisch oder Wand.

**Se ofrecen cuchillas y piezas adicionales.
Extra blades and parts available.
Lames et pièces supplémentaires disponibles.
Zusätzliche Messer und Teile erhältlich.

P975 Cortador de patatas fritas / French fry cutter / Coupe frites / Pommesschneider

Acero inox
Stainless steel
Acier inoxydable
Rostfreier Stahl

**Adaptable a / Adjustable to /
Adaptable à / geeignet für**

**Fuera / Outside /
Extérieur / Außerhalb (max)
1/1 65 mm**

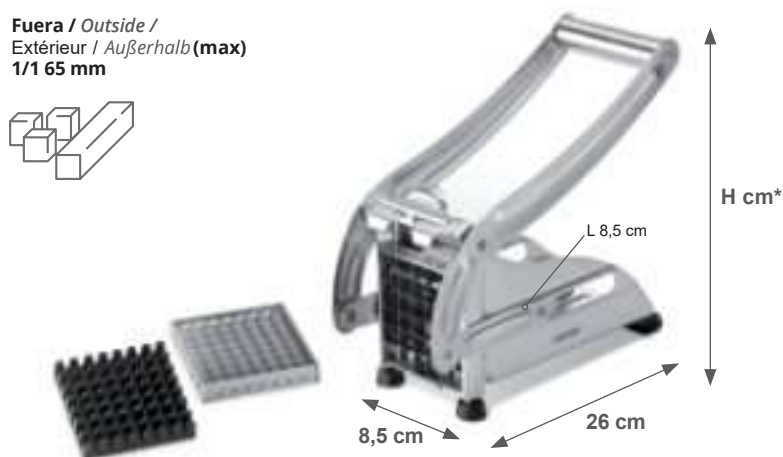
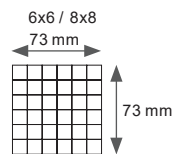

REF	CORTE / CUT COUPE/ SCHNITT mm	AGUJEROS / HOLES / TROUS/ LÖCHER	
P975.000	12 / 9	36 / 64	1
*H 30 cm		Abierto / Open / Ouvert / Offen	
*H 13 cm		Cerrado / Closed / Fermé / Geschlossen	

Sólo cuchilla de reemplazo / Replacement blade only / Lame de rechange seule / Nur ersatzmesser

REF	CORTE / CUT COUPE/ SCHNITT mm	AGUJEROS / HOLES / TROUS/ LÖCHER	
RE975.001	12	36 (6 x 6)	1
RE975.002	9	64 (8 x 8)	1

400N Cortador de lechuga / Salad cutter / Coupe-Salade / Salatschneider



LETTUCE KING® I

Adaptable a /
 Adjustable to /
 Adaptable à /
 Geeignet für (max)
 1/1 100 mm
 1/2 150 mm



434
 17 x 15 cm

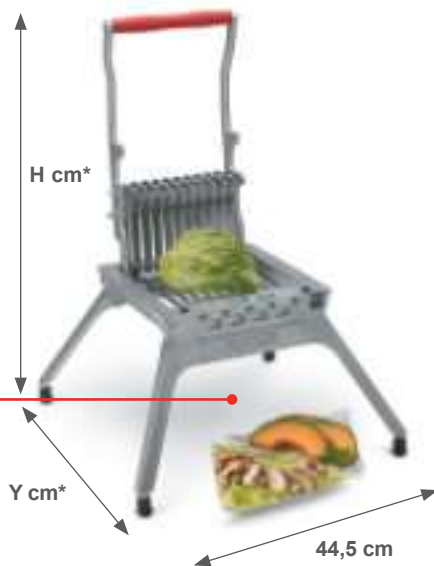

REF	TIPO / TYPE	CORTE / CUT COUPE/ SCHNITT mm	AGUJEROS / HOLES / TROUS/ LÖCHER	
400N		4,8	37	1
402NC		9,5	19	1

*Y 48,3 cm H 45,7 cm **Abierto / Open / Ouvert / Offen**
 *Y 59,1 cm H 43,5 cm **Cerrado / Closed / Fermé / Geschlossen**

Conjunto de cuchillas / Blade assembly /
Jeude lames / Messereinheit

REF	PARA / FOR / POUR/ FÜR	CORTE / CUT COUPE/ SCHNITT mm	CUCHILLAS / BLADES / LAMES/ MESSER	
DADOS - BASTONCILLOS / DICE & STICKS / CUBESETBÄTONNETSI WÜRFEL UND STÄBCHEN				
435	400N	4,8	37	1
485	403N	6,4	28	1
484C	402NC	9,5	19	1

Corte un cuarto de cabeza de lechuga a la vez.
 Cut a quarter head of lettuce at a time.
 Coupez un quart de tête de laitue à la fois.
 Schneidet jeweils ein Salatkopfviertel.

5X Más rápido / Faster



4400N Cortador de lechuga / Salad cutter / Coupe-Salade / Salatschneider



LETTUCE KING® IV

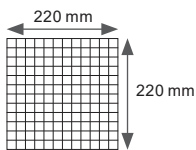

Adaptable a /
 Adjustable to /
 Adaptable à /
 Geeignet für (max)
 1/1 200 mm
 1/2 200 mm

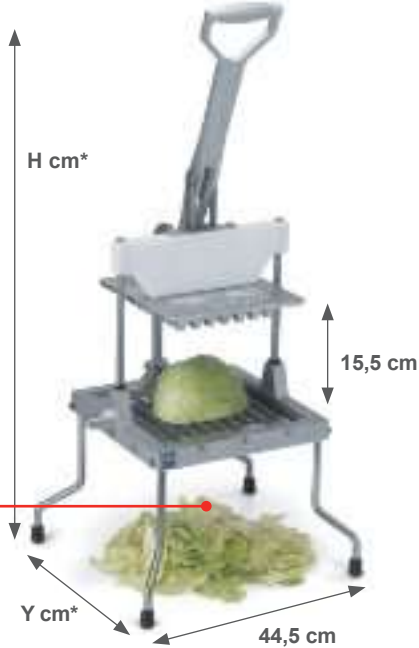

REF	TIPO / TYPE	CORTE / CUT COUPE/ SCHNITT mm	
DADOS - BASTONCILLOS / DICE & STICKS / CUBESETBÄTONNETSI WÜRFEL UND STÄBCHEN			
4400N		25,4 x 25,4	1

*Y 43,2 cm H 81,3 cm **Abierto / Open / Ouvert / Offen**
 *Y 47 cm H 54,9 cm **Cerrado / Closed / Fermé / Geschlossen**

Conjunto de cuchillas / Blade assembly /
Jeude lames / Messereinheit

REF	TIPO / TYPE	CORTE / CUT COUPE/ SCHNITT mm	
DADOS - BASTONCILLOS / DICE & STICKS / CUBESETBÄTONNETSI WÜRFEL UND STÄBCHEN			
4408		25,4 x 25,4	1

No oscurece la lechuga.
 Does not bruise the lettuce.
 N'abime pas la laitue.
 Vermeidet Verletzungen der
 empfindlichen Salatblätter

5X Más rápido / Faster



4408

403NH Rebanadora de frutas y verduras / Fruit & vegetable slicer / Coup-fruit et légumes / Obstschneider

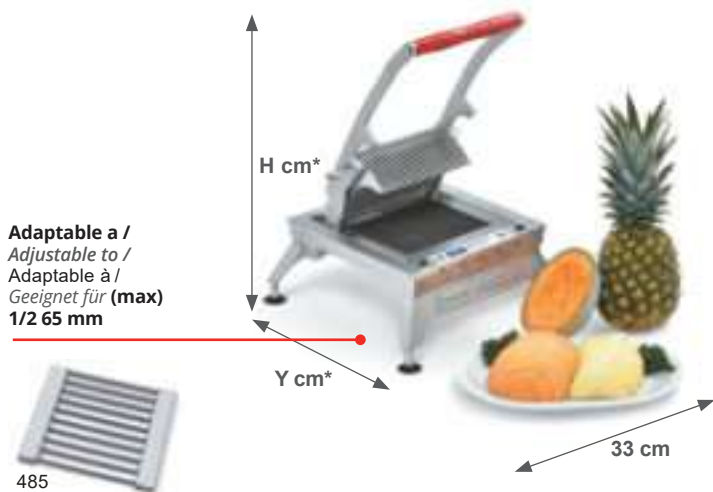

Adaptable a /
Adjustable to /
Adaptable à /
Geeignet für (max)
1/2 65 mm

485

REF	TIPO / TYPE	CORTE / CUT COUPE / SCHNITT mm	CUCHILLAS / BLADES / LAMES / MESSER	
SACACORAZONES / CORE / ÉVIDOIR / ENTKERNER				
403NH		6,4	28	1

*Y 33,6 cm H 50,8 cm Abierto / Open / Ouvert / Offen
*Y 55,7 cm H 23,3 cm Cerrado / Closed / Fermé / Geschlossen

Sólo cuchilla de reemplazo / Replacement blade only /
Lame de rechange seule / Nur ersatzmesser

REF	TIPO / TYPE	CORTE / CUT COUPE / SCHNITT mm	CUCHILLAS / BLADES / LAMES / MESSER	
SACACORAZONES / CORE / ÉVIDOIR / ENTKERNER				
485		6,4	28	1

Área de corte completa de 12,7 cm para frutas grandes.
Full 12.7 cm cutting area optimal for large fruits.
Longueur de coupe de 13 cm optimale pour les fruits volumineux.
Großer 12,5-cm-Schneidbereich eignet sich optimal für große Obstsorten.

No oscurece la fruta durante el corte, reduciendo así los desechos.
Prevents bruising of fruit during cutting, reducing food waste.
N'abîme pas le fruit durant la coupe, réduisant le gaspillage.
Verhindert Quetschverletzungen am Obst beim Schneiden und reduziert die Verschwendung.

500N Cortador de cebollas / Onion cutter / Coupe-onions / Zwiebelschneider

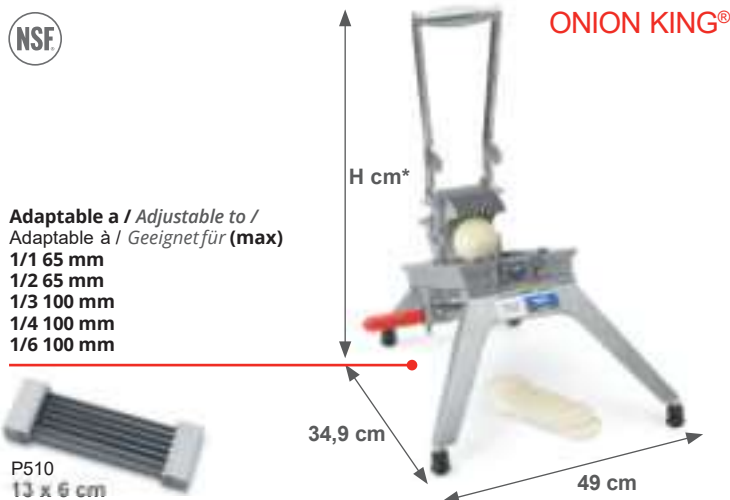

Adaptable a / Adjustable to /
Adaptable à / Geeignet für (max)
1/1 65 mm
1/2 65 mm
1/3 100 mm
1/4 100 mm
1/6 100 mm

P510

13 x 6 cm

ONION KING®

REF	TIPO / TYPE	CORTE / CUT COUPE / SCHNITT mm	CUCHILLAS / BLADES / LAMES / MESSER	
SACACORAZONES / CORE / ÉVIDOIR / ENTKERNER				
500N		4,8	13	1
501N		6,4	11	1

*H 49 cm Abierto / Open / Ouvert / Offen
*H 39,4 cm Cerrado / Closed / Fermé / Geschlossen

Conjunto de cuchillas / Blade assembly /
Jeude lames / Messereinheit

REF	PARA / FOR / POUR / FÜR	CORTE / CUT COUPE / SCHNITT mm	CUCHILLAS / BLADES / LAMES / MESSER	
509	500N	4,8	13	1
511	501N	6,4	11	1

Espesor de rebanada exacto / Exact slice thickness.
Épaisseur de tranches exacte / Exakte Scheibendicke.

2,5X Más rápido / Faster



15604 Cortador cebollas en flor / Bloom onion cutter / Coupe onion en fleur / Zwiebelschneider in Blumenform



INSTABLOOM® II

REF	SECCIONES / SECTION / QUARTIERS / STÜCK	
15604	24	1

*H 76,2 cm Abierto / Open / Ouvert / Offen
*H 48,3 cm Cerrado / Closed / Fermé / Geschlossen

Conjunto de cuchillas / Blade assembly /
Jeude lames / Messereinheit

REF	SECCIONES / SECTION / QUARTIERS / STÜCK	
15601	24	1

Fabricación de aluminio moldeado altamente resistente.
Constructed from heavy duty cast aluminum.
En aluminium coulé ultra-robuste.
Aus stark belastbarem Aluminiumguss.

Tiene cuchillas de acero inoxidable con bordes de precisión.
Features precision edged stainless steel blades.
Lames inox de précision.
Mit präzisionsgefertigten Edelmessern.

Con ventosas de agarre en la base.
With suction cup base.
Avec ventouse d'accrochement à la base.
Mit Saugfüßen.

15601



606N Cortador seccionador de tomates y cítricos / *Tomato and lemon wedger* /
Diviseur à tomates et agrumes / *Wedger Schneider*



WEDGEMASTER™

REF	SECCIONES / SECTION / QUARTIERS/ STÜCK	SE VENDE CON CUCHILLAS / SHIPS WITH BLADES / DESCRIPTION DE LA COUPE/ MESSER IM LIEFERUMFANG ENTHALTEN	
606N	6	P306/P336	1
808N	8	P308/P338	1

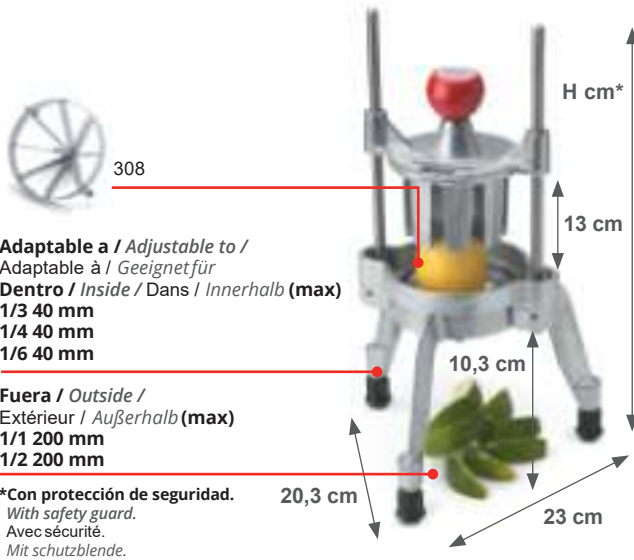

Conjunto de cuchillas / *Blade assembly* /
Jeude lames / *Messereinheit*

REF	TIPO / TYPE	SECCIONES / SECTION / QUARTIERS/ STÜCK	
GAJOS / WEDGE / QUARTIERS/ ZERTEILER			
306		6	1
308		8	1

*H 40,6 cm Abierto / *Open* / Ouvert / *Open*
*H 40,3 cm Cerrado / *Closed* / Fermé / *Geschlossen*

3X Más rápido / *Faster*



700-1 Cortador seccionador de tomates y cítricos / *Tomato and lemon wedger* /
Diviseur à tomates et agrumes / *Wedger Schneider*



WEDGEMASTER™ II

REF	TIPO / TYPE	SECCIONES / SECTION / QUARTIERS/ STÜCK	
700-1		6	1
700-4		8	1

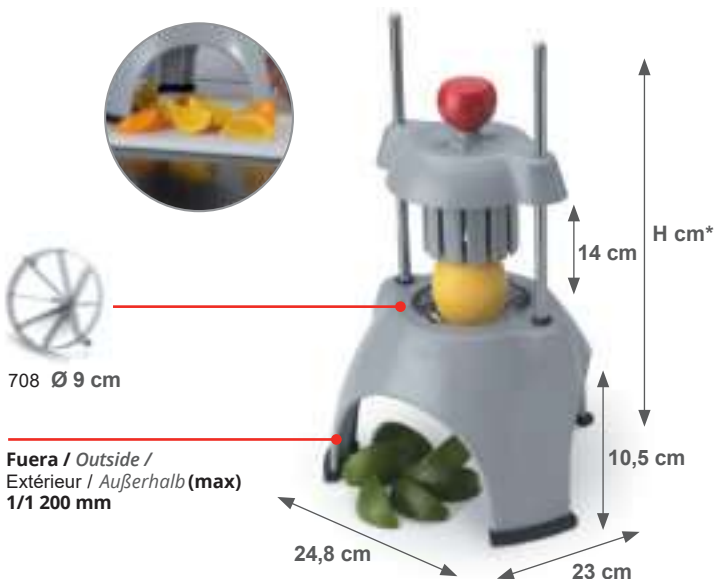

Conjunto de cuchillas / *Blade assembly* /
Jeude lames / *Messereinheit*

REF	TIPO / TYPE	SECCIONES / SECTION / QUARTIERS/ STÜCK	
GAJOS / WEDGE / QUARTIERS/ ZERTEILER			
704		4 ●	1
706		6 ●	1
708		8 ●	1
712		12 ●	1

*H 40,6 cm Abierto / *Open* / Ouvert / *Open*
*H 38,7 cm Cerrado / *Closed* / Fermé / *Geschlossen*

Fabricación de material de policarbonato para lavavajillas.
Constructed of dishwasher safe polycarbonate material.
En polycarbonate qui passe au lave-vaisselle.
Aus spülmaschinenfestem Polycarbonatmaterial hergestellt.

Compatible / *Kompatibel*





3X Más rápido / *Faster*



P937 Máquina multi-usos / Versatil machine / Machine universel / Universelle Maschine





REF	H cm	
P937.000	80	1
REF	H cm	
RE937.001	Recambio cortador patatas / French fry cutter spare part / Coupe frites (pièce rechange) / Austauschbarer Pommesschneider	1
RE937.002	Recambio cortador manzanas / Apple cutter spare part / Coupe pommes (pièce rechange) / Austauschbarer Apfelschneider	1
RE937.003	Recambio exprimidor zumos / Juicer spare part / Press fruits (pièce rechange) / Austauschbarer Entsafter	1

1811 Cortador en cubos / Cube cutter / Coupe en cubes / Würfelschneider

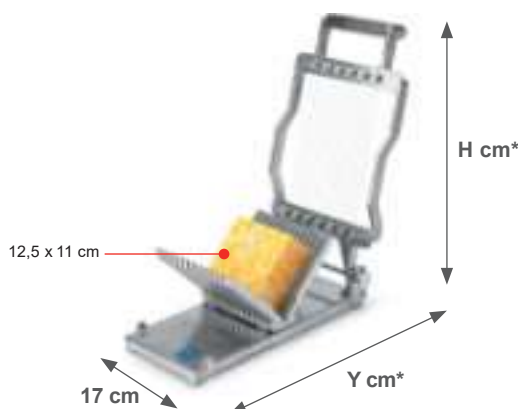

CUBEKING™



REF	CORTE / CUT COUPE / SCHNITT mm	
1811	19,1	1
1812	9,5	1
*Y 33 cm	*H 34 cm	Abierto / Open / Ouvert / Offen
*Y 32 cm	*H 11 cm	Cerrado / Closed / Fermé / Geschlossen
REF	Juego de alambres de repuesto / Replacement wire kit / Kit de fil de rechange / Draht-ersatzkit	
1823		

Produce cubos, palillos y bloques cuadrados o rectangulares de queso.
Produce uniform cheese cubes, sticks, and square or rectangular blocks.
Produisez des dés, bâtonnets et blocs carrés ou rectangulaires de fromage.
Erzeugen Sie einheitlich große Käsewürfel, Stäbchen und quadratische oder rechteckige Blöcke.



P9759 Cortador de tomates / Tomatoes slicer / Coupe tomates / Tomatenschneider



REF	CORTE / CUT COUPE / SCHNITT mm	cm	
P975.900	6,4	39 x 21,5 x 20	1
RE975.901	6,4	25 x 6,8	1

5X Más rápido / Faster



RE975.901
Cuchilla / Blade / Lame / Klinge

0643N Cortador de tomates / Tomatoes slicer / Coupe tomates / Tomatenschneider

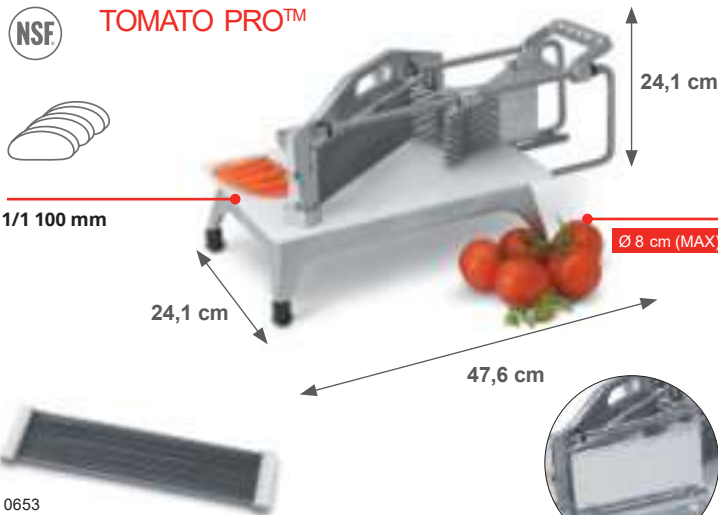

REF	CORTE / CUT COUPE / SCHNITT mm	CUCHILLAS / BLADES / LAMES / MESSER	
0644N**	6,4	11	1
0644SGN**^	6,4	11	1

Cuchilla de reemplazo / Replacement blade item /
Lame de recharge / Ersatzmesser

REF	CORTE / CUT COUPE / SCHNITT mm	CUCHILLAS / BLADES / LAMES / MESSER	
*0653	4,8	15	1
**0654	6,4	11	1

^ Con protección de seguridad.
With safety guard.
Avec sécurité.
Mit Schutzblende.

Permite sujeción a la mesa.
Holds firmly on countertop.
Fixation ferme sur la table.
Hält fest auf dem Tisch.

5X Más rápido / Faster



15105 Cortador de tomates / Tomatoes slicer / Coupe tomates / Tomatenschneider

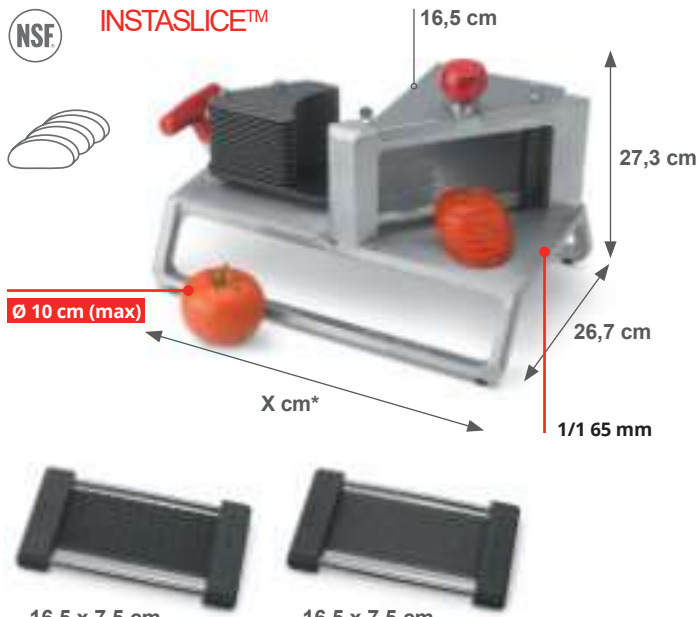

REF	TIPO / TYPE	CORTE / CUT COUPE / SCHNITT mm	CUCHILLAS / BLADES / LAMES / MESSER	
15105^		4,8	16	1
15103^		6,4	12	1

*X 44,5 cm Abierto / Open / Ouvert / Offen
*X 40,6 cm Cerrado / Closed / Fermé / Geschlossen

Cuchilla de reemplazo / Replacement blade item /
Lame de recharge / Ersatzmesser

REF	TIPO / TYPE	CORTE / CUT COUPE / SCHNITT mm	CUCHILLAS / BLADES / LAMES / MESSER	
15115^		4,8	16	1
15209^^		4,8	16	1
15113^		6,4	12	1
15114^		9,5	8	1

Conjuntos de cuchillas encajables para facilitar el reemplazo.

'Pop-in pop out' blade assemblies for easy replacement.
Lames qui s'installent se sortent par détente pour un remplacement facile.
Messer lassen sich zum einfachen Auswechseln leicht einsetzen und herausnehmen.

5X Más rápido / Faster



Resistente a la corrosión.
Corrosion resistant.
Résistant à la corrosion.
Korrosionsbeständig.

P9640 **Abrelatas industrial acero inoxidable / St/Steel can opener /**
Ouvre-boîtes professionnel en acier inoxydable / Industrieller Edelstahl Dosenöffner



REF	H cm	
P964.001	60	1

Cuchilla de recambio / Knife (spare part) /
Couteau (pièce de rechange) / Austauschklinge

REF	
RE964.100	1

Rodillo de recambio / Wheel (spare part) /
Rouleau (pièce de rechange) / Austauschrad

REF	
RE964.200	1

55 cm
Altura máxima de las latas.
Maximum height of cans.
Hauteur maximale des boîtes.
Maximale Höhe der Dosen.

P390 **Cortahuevos guitarra de acero inox /**
St/Steel egg slicer /
Coupe-oeuf en acier inox /
Eierschneider rostfrei



REF	cm	
P390.000	7,7 x 9,4	1

P3901 **Cortahuevos doble uso /**
2 way egg cutter /
Coupe-oeuf 2 utilisations /
2 Weg Eierschneider



REF	cm	
P390.100	11,5 x 9,5 x 3,5	1

P610 **Cortador y descorazonador manzanas /**
Apple cutter & corer /
Vide et coupe pommes /
Apfelschneider und Entherzer



Cuchilla en acero inoxidable y marco en aluminio de fundición

St/Steel blades with cast aluminium frame

Lames inox et manche en aluminium foncé

Messer aus rostfreiem Stahl und Rahmen aus Aluminiumguss



REF	Ø cm	
P610.000	8,5	1

P938 **Prensa ajos / Garlic Press /**
Presse-ail / Knoblauchpresse

Aluminio fundición
Cast aluminium
Fonté d'aluminium
Aluminiumguss



REF	
P938.000	1

P9755 Mandolina corte "V" / "V" shaped mandoline slicer /
"V" mandoline / "V" Gemüsehobel

PLASTICO / PLASTIC /
PLASTIQUE / PLASTIK

Incluye: 2 cuchillas + 3 guías plástico grosor (1 mm / 2 mm / 3 mm) /
Includes: 2 julienne blades + 3 thickness guides (1 mm / 2 mm / 3 mm) /
Comprend: 2 lames julienne + 3 guides épaisseur (1 mm / 2 mm / 3 mm) /
Inklusive: 2 Klingen + 3 Schneideplatten (1 mm / 2 mm / 3 mm)

Pies goma antideslizantes.
Non-slip rubber feet.
Pieds en caoutchouc antidérapants.
Rutschfeste Gummifüße.



REF	CORTE / CUT COUPE/ SCHNITT mm	CUCHILLAS / BLADES / LAMES/ MESSER	
P975.500	4 / 7	24 / 12	1

9756 Mandolina / Mandoline / Mandoline / Mandoline

ACERO INOXIDABLE / ST/STEEL /
ACIERINOXYDABLE/ ROSTFREIER STAHL

Incluye: cuchilla giratoria + regulador de espesor corte (3, 6 y 9 mm) /
Includes: rotating blades + thickness regulator (3, 6 and 9 mm) /
Comprend: lames tournantes + regulateur épaisseur (3,6 et 9 mm) /
Inklusiv: drehbare Klinge + Breitenregulierer (3, 6 und 9 mm)

Rebanada, rebanada ondulada y bastoncillos.
Slice, wavy slice and sticks.
Tranches, ondulé tranches et bâtonnets.
Scheib, crinkle scheid und stäbchen.

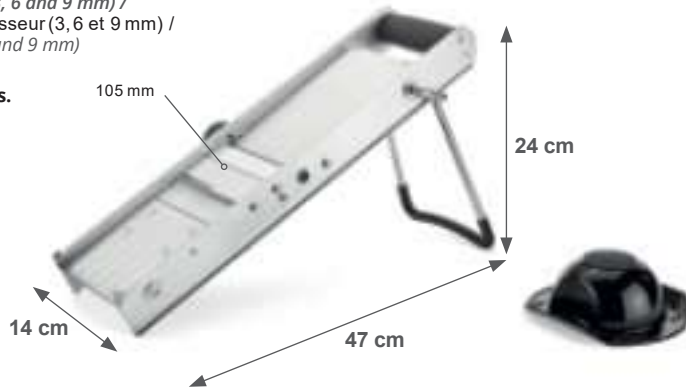

REF	CORTE / CUT COUPE/ SCHNITT mm	CUCHILLAS / BLADES / LAMES/ MESSER	
P975.600	4 / 9	23 / 11	1

1400 Descorazonador de tomates / Tomato corer / Permet d'ôter le coeur de la tomate / Tomatenentkerner

TOMATO KING®



REF	
1400	144

Dientes de acero inoxidable.
Stainless steel teeth.
Dents en inox.
Edelstahlzähne.

Paquete a granel /
Bulk pack /
Paquet en vrac /
Großpackung

15149 Gel lubricante sanitario / Sanitary gel lubricant / Gel lubrifiant sanitaire / Medizinisches Gleitgel

PETROL GEL



REF	ml	
15149	118	1



PESCADO CRUDO
 RAW FISH
 POISSON CRU
 ROHER FISCH



CARNE CRUDA
 RAW MEAT
 VIANDE CRU
 ROHES FLEISCH



CARNE CRUDA DE AVE
 RAW POULTRY & CHIKEN
 VIANDE CRU ET VOLAILLES
 ROHES GEFLÜGEL



ANTIALÉRGICO
 ALLERGEN-FREE
 ANTI ALLERGIQUE
 ANTI ALLERGIE



PAN Y LÁCTEOS
 BAKERY & DAIRY
 PAIN ET PRODUITS LAITIERS
 BROT UND MILCHPRODUKTE



CARNE GUISADA
 COOKED MEAT
 VIANDE CUISINÉE
 GEKOCHTES FLEISCH



FRUTA Y VEGETALES
 FRUIT & VEGETABLES
 FRUIT ET LÉGUMES
 OBST & GEMÜSE



PRESENTACIÓN
 PRESENTATION
 PRÉSENTATION
 PRÄSENTATION

Presentamos una nueva gama de tablas de corte con más de 20 modelos distintos y más de 100 referencias, concebidas para satisfacer todas las necesidades del mercado. Ofrecemos también la posibilidad de fabricar medidas y grosores especiales sobre pedido. La nueva gama de tablas de corte se presenta en dos modalidades; unas fabricadas en Polietileno (PE) por inyección y la gama más extensa en Polietileno 500 alta densidad (HD PE 500) por termocompresión.

We introduce here with the new range of cutting board with more than 20 different patterns and more than 100 references conceived to fulfill all the market needs. We also offer the possibility to produce special sizes and thicknesses upon request. This new range of cutting boards is presented in two different materials, one made of Polyethylene (PE) using the injection technique and the widest range on High Density Polyethylene 500 (HD PE 500) through thermo compression.

Nous présentons une nouvelle gamme de planches à découper avec plus de 20 modèles différents et plus de 100 références, conçues pour satisfaire tous les besoins du marché. Nous offrons aussi la possibilité de fabriquer des planches avec des mesures et des épaisseurs spéciales sur commande. Cette nouvelle gamme de planches à découper se présente en deux matériaux différents: certaines sont produites en Polyéthylène (PE) par injection et la majorité de la gamme est produite en Polyéthylène 500 de haute densité (HD PE 500) par thermo compression.

Wir präsentieren eine neue Produktreihe von Schneidebrettern mit mehr als 20 verschiedenen Modellen und über 100 Artikel, um die Bedürfnisse des Markts zufrieden zu stellen. Wir bieten auch die Möglichkeit spezielle Masse und Dicke herzustellen abhängig von der Bestellung. Die neue Produktreihe bieten wir in zwei verschiedenen Varianten an: Eine Variante hergestellt aus Polyethylen (PE) durch Spritzverfahren und die breiteste Produktvariante hergestellt aus Polyethylen 500 hohe Dichte (HD PE 500) durch Wärmedruckverfahren.



CARACTERÍSTICAS PRINCIPALES

Las tablas de corte fabricadas en Polietileno 500 alta densidad, se caracterizan por un alto peso molecular (HMWPE) ofreciendo:

- Alta DURABILIDAD
- 25% más resistencia a la ABRASIÓN.
- Mayor temperatura de fusión: 135,4 °C.
- Temperatura de reblandecimiento: 83 °C
- Mayor RIGIDEZ

* No presentan deformación durante el aclarado del ciclo de lavado en lavavajillas industriales (temp. máx. aprox. 80 °C).

Conforme a las normativas siguientes: RD 1712/91 registro sanitario de alimentos CE1935/2004.

MAIN FEATURES

The cutting boards made of High Density Polyethylene 500 have higher molecular weight (HMWPE), offering the following properties:

- High DURABILITY
- 25% more resistance to ABRASION
- Higher Fusion temperature: 135,4 °C
- Softening temperature: 83 °C
- Extraordinary RIGIDNESS

* Do not present deformation during the rinsing process of industrial dishwasher cleaning cycle (max. temp. aprox. 80 °C).

Following the CE 1935/2004 regulation.

CARACTÉRISTIQUES PRINCIPALES

Les planches à découper fabriquées en Polyéthylène 500 haute densité ont un poids moléculaire (HMWPE) plus grand qui offre les suivantes propriétés:

- Longue DURÉE
- 25% plus résistant à l'ABRASION
- Température de fusion: 135,4 °C
- Température de ramollissement: 83 °C
- RIGIDITÉ maximale

* Ne présente pas de déformation lors du cycle lavage dans le lave-vaisselles industriel (Temp. max. aprox. 80 °C).

Conforme à la réglementation 1935/2004.

HAUPTEIGENSCHAFTEN

Die Schneidebretter hergestellt aus Polyethylen 500 hohe Dichte haben ein höheres Molekulargewicht (HMWPE), mit folgenden Eigenschaften:

- Hohe LANGLEBIGKEIT
- 25% höherer Verschleisswiderstand
- Höhere Schmelztemperatur: 135,4 °C
- Erweichungstemperatur: 83 °C
- Extrahohe Starrheit

* Estreten keine Verformungen beim Spülvorgang in industriellen Spülmaschinen auf (max. Temp. ca. 80 °C).

Entsprechend der Norm CE1935/2004.

P9118

300 x 200 x 20



Con pies silicona
With silicon feet
Avec pieds en silicone
Mit Silikonfüßen

REF	Color	mm	H mm	
P911.801		300 x 200	20	1
P911.802		300 x 200	20	1
P911.803		300 x 200	20	1
P911.804		300 x 200	20	1
P911.805		300 x 200	20	1
P911.806		300 x 200	20	1
P911.808		300 x 200	20	1

P9112



Con pies silicona
With silicon feet
Avec pieds en silicone
Mit Silikonfüßen

REF	Color	mm	H mm	
P911.201		400 x 300	20	1
P911.202		600 x 400	20	1

P9120

400 x 200 x 20



Con pies silicona
With silicon feet
Avec pieds en silicone
Mit Silikonfüßen

REF	Color	mm	H mm	
P912.001		400 x 200	20	1

P9113 GN 1/1



Con ranura
With groove
Avec rigole
Mit Fuge

Con pies silicona
With silicon feet
Avec pieds en silicone
Mit Silikonfüßen

REF	Color	mm	H mm	
P911.301		530 x 325	20	1
P911.302		530 x 325	20	1
P911.303		530 x 325	20	1
P911.304		530 x 325	20	1
P911.305		530 x 325	20	1
P911.306		530 x 325	20	1

P9117 GN 1/2

320 x 265 x 20



Con pies silicona
With silicon feet
Avec pieds en silicone
Mit Silikonfüßen

REF	Color	mm	H mm	
P911.701		320 x 265	20	1

P9114

400 x 300 x 20



Con pies silicona
With silicon feet
Avec pieds en silicone
Mit Silikonfüßen

REF	Color	mm	H mm	
P911.401		400 x 300	20	1
P911.402		400 x 300	20	1
P911.403		400 x 300	20	1
P911.404		400 x 300	20	1
P911.405		400 x 300	20	1
P911.406		400 x 300	20	1
P911.408		400 x 300	20	1

Ver productos en / See products on / Voir produits en page / Siehe produkte in

P.
202

SOPORTE PARA TAPAS GN /
STAND FOR GN LIDS /
SUPPORT POUR COUVERCLES GN /
STÄNDER FÜR GN DECKEL

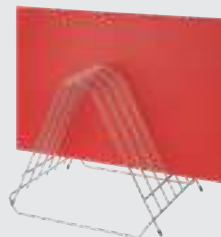

P9119

500 x 300 x 20



Con pies silicona
With silicon feet
 Avec pieds en silicone
 Mit Silikonfüssen

REF	Color	mm	H mm	
P911.901		500 x 300	20	1
P911.902		500 x 300	20	1
P911.903		500 x 300	20	1
P911.904		500 x 300	20	1
P911.905		500 x 300	20	1
P911.906		500 x 300	20	1
P911.908		500 x 300	20	1

P9115 GN 1/1

530 x 325 x 20



Con pies silicona
With silicon feet
 Avec pieds en silicone
 Mit Silikonfüssen

REF	Color	mm	H mm	
P911.501		530 x 325	20	1
P911.502		530 x 325	20	1
P911.503		530 x 325	20	1
P911.504		530 x 325	20	1
P911.505		530 x 325	20	1
P911.506		530 x 325	20	1
P911.508		530 x 325	20	1

P9116

600 x 400 x 20



Con pies silicona
With silicon feet
 Avec pieds en silicone
 Mit Silikonfüssen

REF	Color	mm	H mm	
P911.601		600 x 400	20	1
P911.602		600 x 400	20	1
P911.603		600 x 400	20	1
P911.604		600 x 400	20	1
P911.605		600 x 400	20	1
P911.606		600 x 400	20	1
P911.608		600 x 400	20	1

P9135 Bar



Sin pies
Without feet
 Sans pieds
 Ohne Füsse

REF	Color	mm	H mm	
P913.501		160 x 250	10	1
P913.601		250 x 200	10	1
P913.701		300 x 200	10	1
P913.901		320 x 240	10	1

P911407 **Tabla de corte / Cutting Board /** **Planche à découper / Schneidbretter**



Con pies silicona
With silicon feet
 Avec pieds en silicone
 Mit Silikonfüssen

REF	mm	H mm	
P911.407	400 x 300	20	1
P911.507	530 x 325 (1/1)	20	1
P911.607	600 x 400	20	1

P9130 **Mesa de corte / Cutting board table /** **Table de découpe / Schneidstisch**



Con ranura
With groove
 Avec rigole
 Mit Fuge

No incluye contenedor Gastronorm
Delivered without the GN container
 Livré sans le bac GN
 Ausschiesslich GN Behälter

Para almacenar alimentos recién cortados en cubeta GN 1/3
Perfect for storing direct cut products into a 1/3 GN pan
 Permet découper les produits directement au dessus du bac Gastronorme 1/3
 Für die Aufbewahrung von frischgeschnittenen Lebensmitteln im Behälter GN 1/3

REF	Color	mm	H mm	
P913.000		650 x 400	110	1

P901 **Recogeverduras inox / St/Steel vegetable picker /** **Pelle à légumes inox / Gemüsehacker rostfrei**



REF	cm	
P901.014	14 x 10	1
P901.018	18 x 12	1



5.4 UTENSILIOS DE COCINA / KITCHEN UTENSILS / USTENSILES DE CUISINE / KÜCHENUTENSILIEN

ELEMENTOS DE MEDIDA / MEASURING UTENSILS / USTENSILES DE MESURE / MESSUTENSILIEN

P609 Balanza digital / Electronic scale / Balance électronique / Digitale Waage



Cable de alimentación no incluido. Funciona con pilas / Power cable not included. Battery powered / Câble d'alimentation non inclus. Fonctionne avec des piles / Stromkabel nicht enthalten. Batteriebetrieben.

REF	kg	Grs	
P609.010	10	2	1

P6092 Balanza digital / Digital kitchen scale / Balance électronique / Digitale Waage



Plataforma en acero inoxidable. Pantalla LED. Funciona con pilas / Surface made of St/Steel. LED Display. Battery powered / Plateau fabriquée en acier inoxydable. Scran LED. Fonctionne avec des piles / Plattform rostfrei. LED Display. Batteriebetrieben.

REF	kg	d (g)	
P609.200	15	1	1

P6097 Balanza electrónica / Electronic kitchen scale / Balance électronique / Elektronische Waage



REF	kg	Grs	Plataforma / Surface / Plateau / Plattform Ø cm	
P609.705	5	1	11	1

Gran precisión / Multifunción de peso / Contador de piezas / Sistema ahorro energía / Bandeja de plástico.

High accuracy / Multi-function weight and counting / Energy-saving system / Plastic Platform.

Haut précision / Multi-fonction des poids / Compteur des pièces / Système d'économie d'énergie / Plateau en plastique.

Hohe Präzision / Multi-Funktion Wiegen / Stückzähler / Energiesparsystem / Plattform Plastik.

P611 Reloj de cocina digital / Kitchen timer alarm / Minuteur de cuisine / Digitale Küchenuhr

Pila no incluida / Battery not included / Pile non incluse / Batterien nicht enthalten.



REF	cm	
P611.000	6,8 x 6,8 x 2,5	1

P9802 Termómetro de cocción / Cooking thermometer / Thermomètre à cuisson / Kochthermometer



Con protección de plástico / With plastic protection / Avec gaine plastique / Mit Plastikschutz.

REF	L cm	Temp. max.	
P980.200	28	100 °C	1

P9816

Termómetro de cocción / Cooking thermometer /
Thermomètre à cuisson / Kochthermometer

Con protección de plástico /
With plastic protection /
Avec gaine plastique /
Mit Plastikschutz

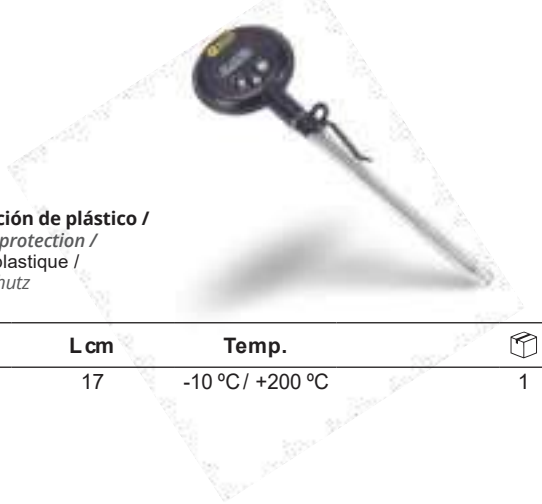

REF	L cm	Temp.	
P981.600	17	-10 °C / +200 °C	1

P9814

Termómetro digital / Digital thermometer /
Thermomètre digital / Digitales Thermometer

Con sonda de acero inoxidable.
Protección antisalpicaduras. Con
pantalla iluminada.
La sonda esta sujeta al lateral del
aparato.

With St/Steel probe. Splash-proof.
Illuminated display.
Probe attached to side panel.

Avec sonde inox. Etanche aux écla-
boussements.
Ecran illuminé. La sonde est attachée
au côté lateral de l'appareil.

Temperaturfühler aus rostfreiem Stahl
Antispritzschutz. Beleuchtetes Display.
Seitlicher Fühlerhalter.



REF	mm	Display mm	Temp.	
P981.400	135 x 92 x 27	42 x 22	-20 °C / +200 °C	1

Termómetro nevera /
Cold storage thermometer /
Thermomètre congelateur /
Külschrankthermometer

P9800

Acabado esmaltado /
Enameled finish /
Émaillé /
Emaillierte Ausfertigung



REF	L cm	Temp.	
P980.000	28	-30 °C / +50 °C	1

P981650

Termómetro bolsillo con protección /
Pocket thermometer with protection /
Thermomètre de poche avec protection /
Taschenthermometer mit Schutz



REF	L cm	Temp.	
P981.650	14,3	-40 °C / +70 °C	24

P9815

Termómetro digital de cocción con temporizador /
Cooking thermometer with timer /
Thermomètre à cuisson avec temporiseur /
Digitales Kochthermometer mit Timer-Funktion

Plástico blanco. Base magnética para
sujeción en superficies de metal.
Temperatura/tiempo programable con
señal de alarma.
Sonda de acero inoxidable y cable alambre.

White plastic. Magnetic base for attachment
on metal surface. Programmable temperature/
time, with alarm signal. St/Steel probe and
wire cable.

Plastique blanc. Base magnétique
pour l'attacher à une surface
métallique. Température/temps
programmable avec sonnette
d'alarme. Sonde inox et filet.

Weisses Plastik. Magnetische Haftung für
metallische Oberflächen. Temperatur/Zeit
programmierbar mit Alarm. Rostfreier Fühler
mit Drahtkabel.



REF	L mm sonda + cable	Temp.	
P981.500	90	0 °C / +200 °C	1

Termómetro nevera horizontal /
Horizontal refrigerator thermometer /
Thermomètre congelateur horizontal /
Horizontales Külschrankthermometer

P98005



REF	mm	Temp.	
P980.050	135 x 35	-40 °C / +20 °C	24

P9804 **Termómetro infrarrojos con mira laser / Infrared thermometer with laser pointer /**
Thermomètre infra-rouge a visée laser / Infrarot Thermometer mit Laser Pointer



REF	L cm	Temp.	
P980.400	17	-60 °C / +500 °C	1

Pantalla LCD
 LCD Display
 Écran LCD
 LCD Display



Ideal para medir la temperatura de la superficie de los alimentos, sin contacto.
Non-contact temperature measure food's surface.
 Ideal pour la mesure de température de surface des aliments, sans contact.
 Ideal für Temperaturmessung von Lebensmittel ohne Berührung.

P604 **Jarra de medidas / Measuring jug /**
Pot mesureur / Messbecher



REF	Lts	
P604.001	1,00	1
P604.002	2,00	1

P846 **Jarra de medidas en polipropileno /**
Polypropylene measuring jug /
Pot mesureur en polypropylène /
Messbecher aus Polypropylen



REF	Lts	
P846.025	0,25	1
P846.050	0,50	1
P846.100	1,00	1
P846.200	2,00	1
P846.300	3,00	1

P6045 **Juego 4 cazos de medidas inox /**
St/Steel 4 pcs set measuring cups /
Set 4 casseroles doseur /
4 teiliges Messkellenset rostfreies Stahl



REF	ml	
P604.500	59 - 78 - 118 - 236	12

P603 **Cubo con base /**
Bucket with base /
Seau avec base /
Eimer mit Skalierung

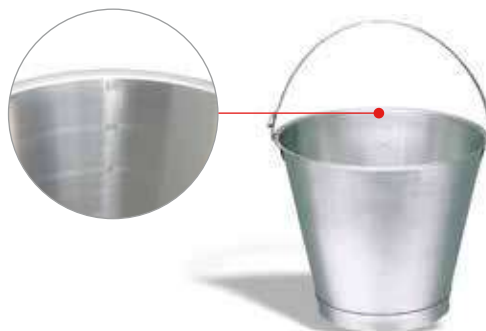

REF	Ø cm	H cm	Lts	
P603.012	31,0	28,50	12,00	1
P603.015	32,5	32,50	15,00	1

P9473 Guantes protección térmica / Heat protection gloves /
Gants protection thermique / Hitzhandschuh



Se venden por pares
Sold in pairs
Vendues par paires
Verkauf im Paar

REF	Talla / Size / Taille / Grösse	
P947.302	M	1
P947.303	L	1

Con recubrimiento de nitrilo exterior y forro algodón interior. Llevan un tratamiento Actifresh y Sanitized que los provee de protección contra los microorganismos los cuales pueden causar malos olores y infecciones.

With an outer nitrile coating and an inner cotton lining. They have an Actifresh and Sanitized treatment that provides protection against micro-organisms which can cause odours and infections.

Avec revêtement extérieur nitrile et doublé coton à l'intérieur. Ils sont traités Actifresh et Sanitized qui les protègent des microorganismes pouvant causer des mauvaises odeurs et des infections.

Mit Nitrilbeschichtung außen und Baumwollfutter innen. Mit Actifresh- und Sanitized-Behandlung zum Schutz gegen Mikroorganismen, die unangenehme Gerüche und Infektionen verursachen können.

P9477 Manopla silicona con funda algodón / Silicone oven glove with cotton cover /
Gant silicone à fourreau coton / Silikonhandschuh mit Baumwollfutter



REF	L cm	
P947.700	42,5	1

P9474 Manopla Silicona / Silicone oven mitt /
Moufle en silicone / Silikonbackhandschuh



REF	L cm	
P947.400	30	1

P9476 Paño de silicona / Silicone pot-grabber /
Torchon en silicone / Silikontuch



REF	cm	
P947.600	17,6 x 17,6	1

P26000 Alfombra / Mat / Tapis / Matte

✓ REACH
COMPLIANT



REF	cm	
P26.000	90 x 150 x 1,20	1

P26001 Alfombra / Mat / Tapis / Matte

✓ REACH
COMPLIANT

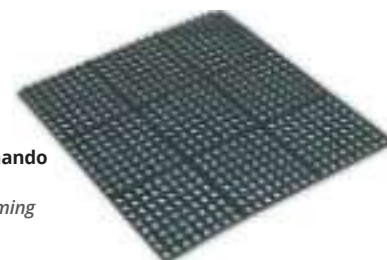

Estas alfombras se pueden conectar unas con otras formando mayores superficies.

You can connect these mats forming bigger surfaces.

Avec système de liaison pour composer une surface plus grande.

Für grössere Flächen kann man diese Matten mit anderen verbinden.

REF	cm	
P26.001	90 x 90 x 1,20	1

ALFOMBRAS CAUCHO / NATURAL RUBBER MATS /
TAPIS EN CAOUTCHOUC / KAUSCHUKMATTEN



HELADERÍA Y PASTELERÍA /
ICE-CREAM UTENSILS & PASTRY /
USTENSILES À GLACE ET PÂTISSERIE /
ZUBEHÖR FÜR EISCREME UND PATISSERIE

- 6.1** **UTENSILIOS HELADERÍA /**
ICE-CREAM UTENSILS /
USTENSILES POUR GLACE /
ZUBEHÖR FÜR EISCREME **148**
-
- 6.2** **UTENSILIOS DE PASTELERÍA /**
PASTRY UTENSILS /
USTENSILES DE PÂTISSERIE /
PATISSERIEZUBEHÖR **150**
-
- 6.3** **MOLDES ANTIADHERENTES /**
NON-STICK MOULDS /
MOULES ANTI-ADHÉSIFS /
ANTIHAFT BACKFORMEN **163**
-
- 6.4** **CORTAPASTAS /**
PASTRY CUTTER /
DÉCOUPOIRS /
TEIGSCHNEIDER **167**
-
- 6.5** **MOLDES ACERO INOXIDABLE /**
ST/STEEL PASTRY MOULDS /
MOULES EN ACIER INOX /
BACKFORMEN ROSTFREIER STAHL **168**
-
- 6.6** **MANGAS Y BOQUILLAS /**
BAGS AND TUBES /
POCHES ET DOUILLES /
SPRITZBEUTEL UND TÜLLEN **171**
-
- 6.7** **MOLDES SILICONA /**
SILICONE MOULDS /
MOULES SILICONE /
SILIKONBACKFORMEN **177**
-
- 6.8** **MOLDES FLEXIPAN /**
FLEXIPAN MOULDS /
MOULES FLEXIPAN /
FLEXIPANBACKFORMEN **182**
-

6.1

HELADERÍA Y PASTELERÍA / ICE-CREAM UTENSILS & PASTRY / USTENSILES À GLACE ET PÂTISSERIE / ZUBEHÖR FÜR EISCREME UND PATISSERIE

47274 Racionador helado / Ice cream scoop / Cuillère à glace / Eiskungelportionierer



REF	COLOR	TAMAÑO / SIZE	BOL cm	L cm	Mlts	
47274	●	8	5,4	19,5	118,3	12
47275	●	10	5,2	19,5	88,7	12
47276	●	12	4,8	19,5	73,9	12
47277	●	16	4,4	19,0	59,1	12
47278	●	20	4,1	19,5	44,4	12
47279	●	24	3,7	19,0	29,6	12

UTENSILIOS HELADERÍA / ICE-CREAM UTENSILS / UTENSILES POUR GLACE / ZUBEHÖR FÜR EISCREME

47150 Racionador helado / Round Squeeze Disher / Doseur à presser ronde / Runde Eisportionierer



REF	TAMAÑO / SIZE	Ø cm	L cm	Mlts	
T7206	6	7,90	23,2	157,6	12
47150	8	6,70	23,2	118,3	12
47151	10	6,50	22,5	92,4	12
47153	16	5,60	21,6	59,1	12
47155	24	4,90	21,0	40,7	12
47157	40	4,10	20,3	25,9	12
47159	60	3,50	19,7	16,6	12
47160	70	3,30	19,7	14,3	12
47161	100	2,90	19,1	11,1	12

P331 Racionador de helado / Ice cream scoop / Cuillère à glace / Eiskugelportionierer



REF	Ø mm	Mlts	
P331.039	39	15	12
P331.044	44	22	12
P331.050	50	32	12
P331.056	56	46	12
P331.059	59	54	12
P331.066	66	75	12
P331.070	70	90	12

P908 Racionador de helado / Ice cream scoop / Cuillère à glace / Eiskugelportionierer



Inox - st/steel
Edelstahl

*Metacrilato / Methacrylate /
Méthacrylate / Metaakrylat

REF	Color / Colour / Couleur / Farbe	L cm	
P908.000	Blanca / White / Blanc / Weiss	26	1
P908.001*	Transparente / Clear / Trasparente / Transparent	26	1
P908.002	Roja / Red / Rouge / Rot	26	1
P908.003	Azul / Blue / Bleu / Blau	26	1
P908.004	Amarilla / Yellow / Jaune / Gelb	26	1

P332 Copa helado / Ice cream cup / Coupe à glace / Eisschale



P332.010

P332.095

REF	Ø cm	H cm	Lts	
P332.095	9,5	8,5	0,15	1
P332.010	10,5	6,0	0,17	12

P914 360 x 165 mm

INOX - ST/STEEL
EDELSTAHL
18/10



REF	mm	H mm	Lts	
P914.080	360 x 165	80	3,4	10
P914.120	360 x 165	120	5	10
P914.150	360 x 165	150	7	10

P915 360 x 250 mm

INOX - ST/STEEL
EDELSTAHL
18/10



REF	mm	H mm	Lts	
P915.080	360 x 250	80	5,4	10

P9161 360 x 165 mm

Policarbonato.
Polycarbonate.
Polycarbonate.
Polycarbonat.



REF	mm	H mm	Lts	
P916.120	360 x 165	120	5	10

P917 360 x 250 mm

Policarbonato.
Polycarbonate.
Polycarbonate.
Polycarbonat.



REF	mm	H mm	Lts	
P917.080	360 x 250	80	3,4	10

P9160 Tapa policarbonato / Polycarbonatelid / Couvercle en polycarbonate / Deckel Polycarbonat



REF	mm	
P916.000	360 x 165	10

Adaptable a cubetas heladería inox y policarbonato.
Adjustable for St/Steel Ice cream containers.
Adaptable aux récipient à glace en acier inox.
Passend für Eisbehälter Edelstahl und Polycarbonat.

PASTELERÍA / PASTRY / PÂTISSERIE / PATISSERIE

PUJADAS ofrece en esta sección los ESENCIALES de la pastelería, todos ellos fabricados en materiales de máxima calidad para ser utilizados de una forma intensiva.

También se presentan multitud de ARTÍCULOS COMPLEMENTARIOS propios del oficio de la pastelería para que el profesional repostero pueda realizar sus labores creativas en las mejores condiciones.

PUJADAS propose un large éventail de MOULES, CERCLES et FORMES TRÈS ROBUSTES, fabriqués AVEC DIFFÉRENTS matériaux d'une qualité maximale pour permettre au professionnel de réaliser des créations de pâtisserie les plus sophistiquées.

PUJADAS propose également de nombreux ARTICLES COMPLEMENTAIRES particuliers à la pâtisserie pour permettre au pâtissier de mener à terme ses tâches de création dans les meilleures conditions possibles

PUJADAS offers an extensive array of extremely resistant MOULDS, RINGS AND FORMS in various materials of the highest quality. Ideally suited for professionals devoted to the creation of their most sophisticated works of art.

A large number of ANCILLARY ITEMS are also introduced to enable professional pastry cooks and confectioners to carry out their creative work in the best possible conditions.

PUJADAS bietet eine grosse Anzahl von Schablonen, Ringen und Formen von aussergewöhnlicher Festigkeit aus verschiedenen Materialien höchster Qualität an. Ideal für jeden Profi, der die höchstentwickelten Nachspeisen kreieren möchte.

Auch präsentieren Wir Ihnen Eine Vielzahl von Konditoreieigenen zugehörigen Artikeln, mit denen der professionelle Konditor seine kreativsten Arbeiten unter den besten Bedingungen realisieren kann.



P3070 Caldero fondo plano / Boiler / Bassine à fond plat / Kessel ebener Boden

INOX - ST/STEEL
EDELSTAHL
18/10



REF	Ø cm	H cm	Lts	
P307.020	20	10,5	2,20	1
P307.025	25	11,5	3,50	1
P307.030	30	14,0	6,00	1
P307.035	35	14,5	8,50	1
P307.040	40	16,5	13,00	1
P307.045	45	17,5	20,00	1
P307.050	50	20,0	25,00	1
P307.060	60	22,5	45,00	1
P307.070	70	24,5	65,00	1

PASTELERÍA /
PASTRY /
PÂTISSERIE

P3071 Caldero fondo bombeado / Conical boiler / Bassine à fond bombé / Kessel kugelförmiger Boden

INOX - ST/STEEL
EDELSTAHL
18/10



REF	Ø cm	H cm	Lts	
P307.125	25	13,0	3,80	1
P307.130	30	16,0	6,50	1
P307.140	40	19,0	13,00	1
P307.150	50	23,5	25,00	1

P306 Caldero timbal / Mixing boiler / Bol mixeur / Rührschüssel

INOX - ST/STEEL
EDELSTAHL
18/10



REF	Ø cm	H cm	Lts	
P306.035	35	18,0	10,00	1

6.2 HELADERÍA Y PASTELERÍA / ICE-CREAM UTENSILS & PASTRY / USTENSILES À GLACE ET PÂTISSERIE / ZUBEHÖR FÜR EISCREME UND PÂTISSERIE

P356 Fuente honda cónica / Kitchen bowl / Bassine pâtissière / Rührschüssel

INOX - ST/STEEL
EDELSTAHL
18/10



Medidas exteriores / Outer sizes /
Dimensions extérieures / Aussenmasse

REF	Ø cm	H cm	Lts	
P356.016	16	5,5	0,65	1
P356.020	20	7,5	1,30	1
P356.024	24	8,5	2,10	1
P356.028	28	11,0	3,70	1
P356.032	32	12,5	6,00	1

UTENSILIOS DE PASTELERÍA / PASTRY UTENSILS / USTENSILES DE PÂTISSERIE / PÂTISSERIEZUBEHÖR

479 Bol inox. semi-esférico / Stainless Steel mixing bowl / Bassine inox demi-ronde / Edelstahlschüssel halbrund



REF	Ø cm	Lts	
47933	24	2,80	12
47934	28	3,80	12
47935	30	4,70	12
47938	35	7,60	6
47943	40	12,00	6

P764 Molde semiesférico / Hemispherical mould / Demi-sphérique / Halbkugelform

INOX - ST/STEEL
EDELSTAHL
18/10



REF	Ø cm	H cm	Lts	
P764.008	8	4,0	0,130	1
P764.010	10	5,0	0,260	1
P764.012	12	6,2	0,450	1

P951 Librador de acero inox / St/steel scoop / Pelle à farine en acier inox / Mehlschaufel rostfreier Stahl

INOX - ST/STEEL
EDELSTAHL
18/10



REF	L cm	Lts	
P951.010	10	0,10	5
P951.015	15	0,40	5
P951.019	19	1,00	5
P951.024	24	1,70	5

P953 Librador aluminio / Aluminium scoop / Pelle à farine aluminium / Mehlschaufel Aluminium

ALUMINIO /
ALUMINIUM



REF	L cm	Lts	
P953.001	11	0,15	12
P953.002	15	0,35	12
P953.003	18,5	0,71	12
P953.004	21,5	1,10	12
P953.005	25,5	1,71	12

P952 Librador policarbonato / Polycarbonate scoop / Pelle à farine polycarbonate / Mehlschaufel Polycarbonat

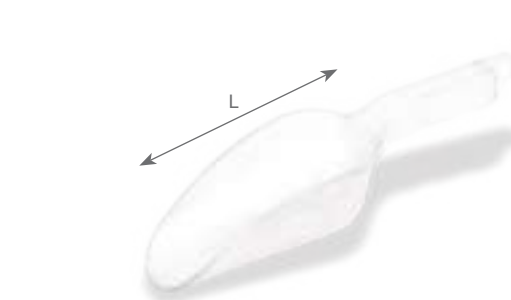

REF	L cm	Lts	
P952.001	13	0,17	12
P952.002	15,5	0,35	12
P952.003	17,5	0,71	12

**HELADERÍA Y PASTELERÍA /
ICE-CREAM UTENSILS & PASTRY /
USTENSILES À GLACE ET PÂTISSERIE /
ZUBEHÖR FÜR EISCREME UND PÂTISSERIE**

**P316 Batidor (12 varillas) / Whisk (12 wires) /
Fouet (12 fils) / Rührbesen (12 Drähte)**

Grueso varilla / Wire thickness /
Epaisseur des fils / Drahtdicke:
1,3 mm



REF	L cm	
P316.025	25	12
P316.030	30	12
P316.035	35	12
P316.040	40	12
P316.045	45	12
P316.050	50	12

**UTENSILIOS DE PASTELERÍA / PASTRY UTENSILS /
USTENSILES DE PÂTISSERIE / PÂTISSERIEZUBEHÖR**

**P3161 Batidor (10 varillas) / Whisk (10 wires) /
Fouet (10 fils) / Rührbesen (10 Drähte)**

Grueso varilla / Wire thickness /
Epaisseur des fils / Drahtdicke:
1,8 mm



REF	L cm	
P316.125	25	12
P316.130	30	12
P316.135	35	12
P316.140	40	12
P316.145	45	12
P316.150	50	12

PASTELERÍA /
PASTRY /
PÂTISSERIE

**P354 Batidor grueso (8 varillas) / Heavy whisk (8 wires) /
Fouet épais (8 fils) / Rührbesen (8 Drähte)**

Grueso varilla / Wire thickness /
Epaisseur des fils / Drahtdicke:
2,4 mm



REF	L cm	
P354.025	25	12
P354.030	30	12
P354.035	35	12
P354.040	40	12
P354.045	45	12
P354.050	50	12

**P959 Batidor mango abs antideslizante (8 varillas) /
Whisk with anti-slip abs handle (8 wires) /
Fouet avec poignée abs anti-crispation (8 fils) /
Rührbesen Antirutschgriff ABS (7 Drähte)**

Grueso varilla / Wire thickness /
Epaisseur des fils / Drahtdicke:
2 mm



REF	L cm	
P959.025	25	12
P959.030	30	12
P959.035	35	12
P959.040	40	12
P959.045	45	12
P959.050	50	12

**P393 Batidor gigante / Big whisk /
Fouet à purée / Grosser Rührbesen**

Grueso varilla / Wire thickness /
Epaisseur des fils / Drahtdicke:
3 mm

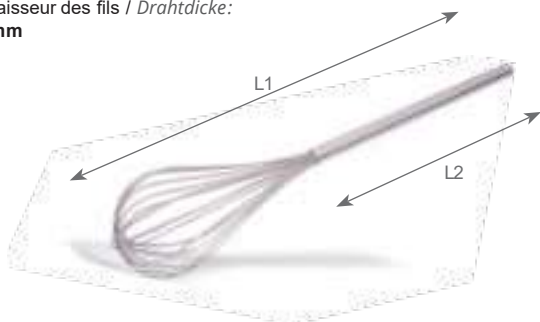

REF	L1 cm	L2 cm	
P393.080	80	45	1
P393.100	100	65	1
P393.125	125	90	1

**47002 Batidor con mango antiadherente /
Whisk with anti-slip handle /
Fouet avec poignée anti-crispation /
Rührbesen Antirutschgriff**

246 °C



REF	L cm	L mango cm	
47002	25,5	12	12
47003	30,5	12	12
47004	35,5	12	12
47005	40,5	12	12

6.2 HELADERÍA Y PASTELERÍA / ICE-CREAM UTENSILS & PASTRY / USTENSILES À GLACE ET PÂTISSERIE / ZUBEHÖR FÜR EISCREME UND PÂTISSERIE

P398 Espátula de goma / Rubber spatula / Spatule en caoutchouc / Gumispachtel



REF	L cm	
P398.024	25,5	24
P398.035	33,0	12
P398.042	41,0	12

Mango ergonómico. Goma aceptada para uso alimentario. Puede lavarse en el lavavajillas. Moldeado especial que previene la separación de la goma del mango.

Anatomical handle. Suitable rubber for food contact. Safe dishwasher. Special mould that prevents the rubber to come off from the handle.

UTENSILIOS DE PASTELERÍA / PASTRY UTENSILS / USTENSILES DE PÂTISSERIE / PÂTISSERIEZUBEHÖR

P398290 Espátula estrecha goma / Narrow rubber spatula / Spatule étroite en caoutchouc / Gerade Gumispachtel



IDEA! Perfecta para vaciar tarros /
Perfect to empty small jars /
Parfait pour vider des petits pots /
Perfekt für das Leeren von schmalen Behältern

REF	Pala / Peel / Pelle / Schaufel cm	L cm	
P398.290	8,8 x 3,3	25,5	24

Manche anatomique. Caoutchouc conforme au contact alimentaire. Utilisable au lave-vaisselle. Moulage spécial pour éviter la séparation de la gomme du manche.

Ergonomischer Griff. Gummi geeignet für die Lebensmittelverarbeitung. Spülmachinenfest. Spezieller Rahmen, der das Trennen von Gummi und Stiel vorsieht.

P3981 Espátula silicona alta temperatura / High heat silicone spatula. Bowl scraper / Spatule silicone haute température / Silikonspachtel hohe Temperaturen

Resistente hasta 260 °C /
Heat resistance to 260 °C /
Résistante à 260 °C /
Hitzeresistent bis 260 °C



REF	Pala / Peel / Pelle / Schaufel cm	L cm	
P398.125	9 x 6	25	24
P398.135	11 x 7	35	12
P398.140	11 x 7	40	12

P3982 Cuchara silicona alta temperatura / High heat silicone spoon / Cuillère silicone haute température / Silikonlöffel hohe Temperaturen

Resistente hasta 260 °C /
Heat resistance to 260 °C /
Résistante à 260 °C /
Hitzeresistent bis 260 °C



REF	Pala / Peel / Pelle / Schaufel cm	L cm	
P398.225	9 x 6	25	1
P398.235	11 x 7	35	1
P398.240	11 x 7	40	1

P9602 Espátula multi-usos / Multi-purpose spatula / Spatule multi-usage / Spachtel Multigebrauch

 -5 °C
 +70 °C



REF	L cm	
P960.225*	25	1
P960.230*	30	1
P960.235**	35	1

*Poliestireno / Polyestyrene / Polyestyrene / Polystyroen
**Polietileno / Polyethylene / Polyéthylène / Polyethylen

P807 Rodillo para perforar pasta / Roller docker / Rouleau pour piquer pâtes / Stipprolle



REF	
P807.000	1

P839 Rodillo perforar pasta / Roller docker / Rouleau pour piquer pâtes / Stipprolle



REF	
P839.000	1

P840 Rodillo enrejado / Lattice cutting roller / Rouleau découpoir / Gitterschneiderolle



REF	
P840.000	1

P842 Cortapastas doble. Liso y rizado / Double pastry cutter. Plain and serrated /
Roulette à pâtes double. Unie et cannelée / Doppelter Teigschneider. Glatt und Gezackt



REF	
P842.000	1

P805 Cortapastas extensible 7 ruedas / Extendable cutter roller 7 castors /
Rouleau extensible 7 roulettes / Ausziebarer Teigschneider 7 Rollen

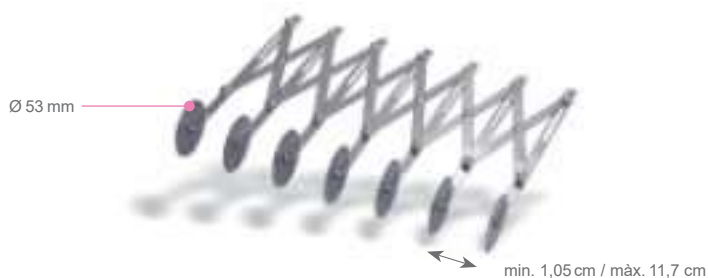

REF	
P805.000	1

6.2 HELADERÍA Y PASTELERÍA / ICE-CREAM UTENSILS & PASTRY / USTENSILES À GLACE ET PÂTISSERIE / ZUBEHÖR FÜR EISCREME UND PÂTISSERIE

Rodillo acero inox /
St/Steel rolling pin /
Rouleau pâtissier acier inox /
Teigrolle rostfreier Stahl

P801

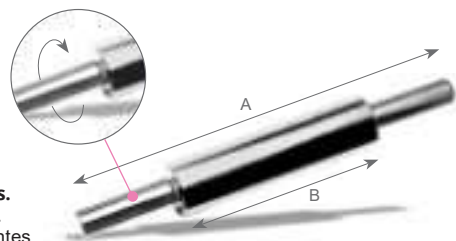

Asas giratorias.
Rolling handles.
Poignées roulantes.
Drehende Griffe.

REF	A cm	B cm	Ø cm	
P801.040	40	20	5,1	3
P801.048	48	25	6,4	3

UTENSILIOS DE PASTELERÍA / PASTRY UTENSILS / USTENSILES DE PÂTISSERIE / PÂTISSERIEZUBEHÖR

Rodillo polietileno con asas /
Polyethylene rolling pin with handles /
Rouleau en polyéthylène avec poignées /
Teigrolle Polyethylen mit Griffen

P802

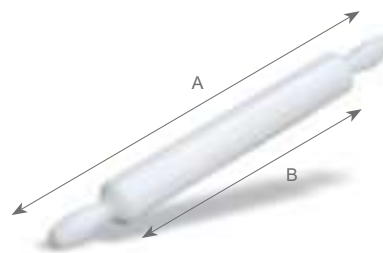

REF	A cm	B cm	Ø cm	
P802.000	60	40	4,8	1

Rodillo polietileno sin asas /
Polyethylene rolling Pin without handles /
Rouleau en polyéthylène Sans poignées /
Teigrolle Polyethylen ohne Griffen

P803



REF	L cm	Ø cm	
P803.000	50	4,8	1

Rodillo de madera / Wooden rolling pin /
Rouleau en bois / *Holzteigrolle*

P804

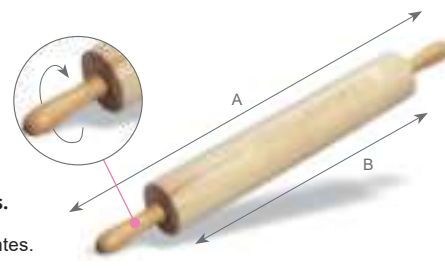

Asas giratorias.
Rolling handles.
Poignées roulantes.
Drehende Griffe.

REF	A cm	B cm	Ø cm	
P804.000	67,5	45,5	7,7	1

Pincel de polietileno / Polyethylene brush /
Pinceau en polyéthylène / *Pinsel Polyethylen*

P845

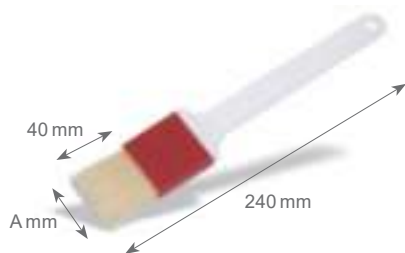

REF	A mm	
P845.040	40	1
P845.050	50	1
P845.060	60	1
P845.075	75	1

Cepillo plástico + cerdas nylon /
Plastic brush + nylon bristle /
Pinceau plastique + poils nylon /
Plastikbürste + Nylonborsten

P8451

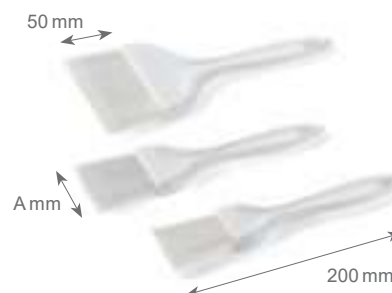

REF	A mm	
P845.138	38	1
P845.155	55	1
P845.110	100	1

P836 Rasquetas de polipropileno / Polypropylene scrapers /
Raclettes en polypropylène / Schaber aus Polypropylen

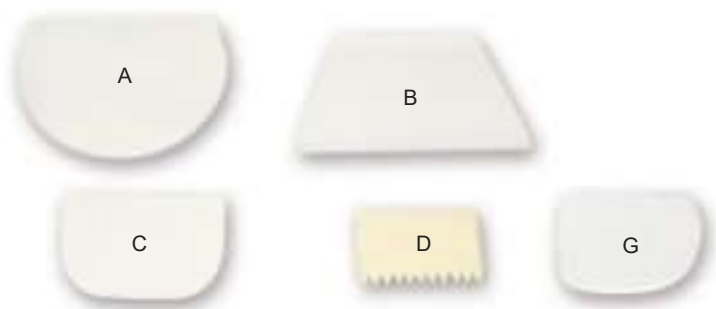

REF		mm	
P836.200	A	204 x 151	1
P836.215	B	221 x 130	1
P836.147	C	151 x 102	1
P836.110	D	112 x 78	1
P836.120	G	128 x 90	1

P848 Marcador de tartas doble / Double cake divider /
Séparateur de portions double / Doppelter Tortenschneider

Ø Total: 26,5 cm



REF	Porciones / Portions / Portionen	
P848.008	8 / 12	1
P848.014	14 / 16	1

Polipropileno.
Polypropylene.
Polypropylène.
Polypropylen.

P8725 Rasqueta mango ABS / Scraper ABS handle /
Raclette manche ABS / Schaber ABS Griff



REF	cm	
P872.500	21 x 14,5	1

Ver productos en / See products on / Voir produits en page / Siehe produkte in

P.
111

UTENSILIOS /
UTENSILS /
USTENSILES /
ZUBEHÖR





P979 Soplete cocina / Pastry torch by gas / Torche à caraméliser / Küchengasbrenner



120 min.

Duración / Lenght / Durée / Dauer

REF	cm	
P979.100	10 x 13,6	1
P979.200	13 x 17,5	1
P979.000	16,5 x 21	1



Descongelación, esterilización, escultura de hielo, crema brulée, caramelización /
Kitchen use, defrosting, sterilizing, ice sculpture, crème brulée, caramelization /
Décongélation, stérilisation, sculpture de glace, crème brûlée, caramélisation /
Auftauen, Sterilisieren, eisskulptur, Crème Brulée, Karamelisieren



Ref. P979.000

Llama super fuerte /
Super strong flame /
Flamme extra fort /
Super starke Flamme



Ref. P979.200

Llama fuerte /
Strong flame /
Fort flamme /
Starke Flamme



Ref. P979.100

Llama normal /
Standar flame /
Flamme normal /
Normale Flamme

PÂTISSERIE /
PASTRY /
PASTELERÍA

Ver productos en / See products on / Voir produits en page / Siehe produkte in

P.
143

TERMÓMETRO BOLSILLO CON PROTECCIÓN /
POCKET THERMOMETER WITH PROTECTION /
THERMOMÈTRE DE POCHE AVEC PROTECTION /
TASCHENTHERMOMETER MIT SCHUTZ



P837 Expositor de tartas de aluminio / Aluminium cake stand /
Présentoir de tartes en aluminium / Tortenständeraus Aluminium

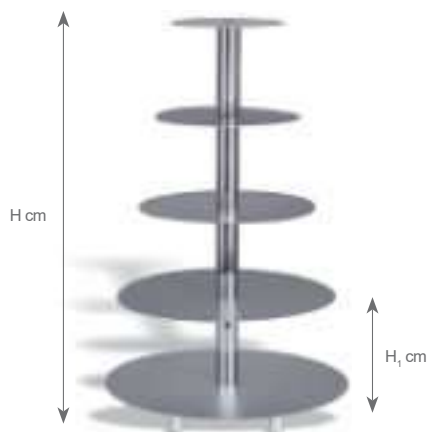

REF	H cm	H ₁ cm	Ø cm	
P837.003	33	2 x 16,5	20 / 26 / 32	1
P837.005	100	4 x 25,0	20 / 26 / 32 / 40 / 45	1
P837.007	120	6 x 20,0	16 / 20 / 26 / 32 / 40 / 45 / 50	1

P8373 Expositor de tartas giratorio / Revolving cake stand /
Présentoir giratoire de tartes / Drehbarer Tortenständer



REF	Ø cm	H cm	
P837.300	30	8	1

P350 Cedazos en acero inox / St/Steel sieves / Tamis en acier inox / Siebe aus rostfreiem Stahl

Detalle de las 6 mallas a escala real.
Detail of the 6 sieves at real scale.
Détail des 6 mailles à échelle réelle.
Detail der 6 Maschen in realer Skala.

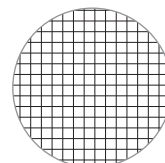
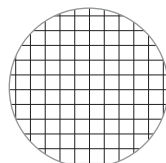

REF	Ø cm	Num	
P350.230	30	10	6
P350.235	34	10	6

REF	Ø cm	Num	
P350.330	30	14	6
P350.335	34	14	6

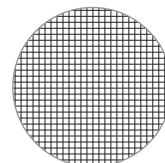
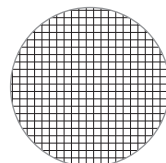

REF	Ø cm	Num	
P350.426	26	20	6
P350.430	30	20	6
P350.435	34	20	6
P350.440	40	20	6

REF	Ø cm	Num	
P350.530	30	25	6
P350.535	34	25	6

NUM.	LUZ DE MALLA / MESH SIZE / MALLAGE / MASCHENWEITE mm
10	2,000
14	1,400
20	0,850
25	0,710
34	0,500
50	0,300

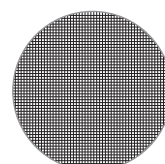
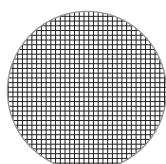

REF	Ø cm	Num	
P350.630	30	35	6
P350.635	34	35	6

REF	Ø cm	Num	
P350.730	30	50	6
P350.735	34	50	6

P830 Embudo dosificador / Confectionery funnel / Entonnoir doseur / Dosierungstrichter



REF	Lts	
P830.001	1,00	1
P830.002	2,00	1

Boquilla recambio Ø 6 mm
Spare tube Ø 6 mm
Douille recharge Ø 6 mm
Austauschbare Öffnung Ø 6 mm

Ver productos en / See products on / Voir produits en page / Siehe produkte in

P.
116

PASTELERÍA /
PASTRY /
PÂTISSERIE

P970

SOPORTE PARA EMBUDO O CHINO /
STAND FOR FUNNEL OR CHINESE COLANDER /
SUPPORT POUR ENTONNOIR OU CHINOIS /
STÄNDER FÜR TRICHTER ODER SIEB



P830.003 Embudo dosificador económico / Economic confectionery funnel /
Entonnoir doseur économique / Ökonomischer Dosierungstrichter



REF	Lts	
P830.003*	1,00	1
P830.004**		1

***Boquilla de recambio Ø 6 mm.**
Spare tube Ø 6 mm.
Douille de recharge Ø 6 mm.
Austauschbare Öffnung Ø 6 mm.

**** Soporte embudo. Se vende por separado.**
Stand for funnel. Sell separately.
Support pour entonnoir. Vendu séparément.
Trichterständer. Separater Verkauf.

P830.005 Embudo dosificador básico con soporte / Basic confectionery funnel with stand /
Entonnoir doseur de base avec support / Basisdosierungstrichter mit Ständer



REF	Lts	
P830.005	1,00	1

Embudo y soporte se venden conjuntamente.
Funnel and stand sold together.
Entonnoir et support vendu ensemble.
Trichter und Ständer werden zusammen verkauft.

2803 Dispensador con control de porciones / Portion control dispenser /
Distributeur contrôle de la partie / Portionskontrollspender



BATTER BOSS®



REF	L	cm	H cm	
2803-18	1,4	15,6 x 27,6	19,1	1

Los ajustes de control de 8 porciones dispensan de 30 a 90 ml.
8 portion control settings dispense from 30 to 90 ml.
8 réglages de dose - 30 à 90 ml.
8 portionskontrolleinstellungen zur ausgabe von 30-90 ml.

No se recomienda para batidos espesos.
Not recommended for chunky batters.
Non recommandé pour les pâtes grumeleuses.
Nicht für bröselige teige empfohlen.

P9095 Rejilla inox pastelería con pies / St/steel pastry grid with feet /
Grille pâtisserie inox avec pieds / Pâtisseriesrostfreier Stahl mit Füßen



t: 1 cm

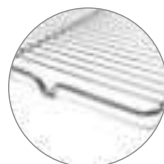

REF	mm	N. Travesaños / N. Cross-bars / N. Traverses / N. Traversen	Ø mm Travesaños / Ø mm Cross-bars / Ø mm Traverses / Ø mm Traversen	N. Varillas / N. Wires / N. Fils / N. Stäbe	Ø mm Varillas / Ø mm Wires / Ø mm Fils / Ø mm Stäbe	
P909.559	590 x 390 x 20	3	5	29	2	1

Ver productos en / See products on / Voir produits en page / Siehe produkte in

ACCESORIOS HORNO /
OVEN ACCESSORIES /
ACCESSOIRES FOUR /
OFENACCESSORIES

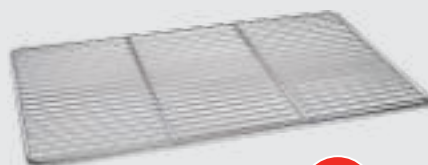

P.
88



P.
92

**HELADERÍA Y PASTELERÍA /
ICE-CREAM UTENSILS & PASTRY /
USTENSILES À GLACE ET PÂTISSERIE /
ZUBEHÖR FÜR EISCREME UND PATISSERIE**

**Molde cake profesional /
Professional cake mould /
Cakeembouti professionnel /
Professionelle Backform**

P7022



REF	cm (int.)	H cm	Lts	
P702.230	30 x 10,5	8,0	2,0	1

**MOLDES ANTIADHERENTES / NON-STICK MOULDS /
MOULES ANTI-ADHÉSIFS/ ANTIHAFT BACKFORM**

**Molde cake /
Cake mould /
Cakeembouti /
Backform**

P702



REF	cm	H cm	
P702.026	26 x 9,5	7,5	1
P702.028	28 x 10	7,5	1

**Molde para paté o cake desmontable /
Folding cake mould /
Pâté ou cake démontable /
Backform für Pastete oder Kuchen demontierbar**

P704



REF	cm	H cm	
P704.024	24 x 9,5	7,0	1
P704.030	30 x 10	7,5	1

**Molde fondo desmontable /
Baking mould w/removable base /
Tarte maison a/fond amovible /
Backform Boden demontierbar**

P709



REF	cm	H cm	
P709.035	35 x 11	2,5	1

**Placa madalenas pequeñas /
Small madeleine sheet /
Plaque madeleinettes /
Backblech kleine Madeleine**

P707

**2 hileras de 10 madalenas pequeñas de 4,2 cm.
2 rows of 10 small madeleines of 4,2 cm.
2 rangées de 10 madeleinettes de 4,2 cm.
2 Reihen von 10 kleinen Madeleinen von 4,2 cm.**



REF	cm	
P707.039	39,5 x 12,5	6

**Placa madalenas /
Madeleine sheet /
Plaque madeleines /
Backblech Madeleine**

P706

**2 hileras de 6 madalenas de 8 cm.
2 rows of 6 madeleines of 8 cm.
2 rangées de 6 madeleines de 8 cm.
2 Reihen von 6 Madeleinen von 8 cm.**



REF	cm	
P706.039	39,5 x 20	6

6.3

HELADERÍA Y PASTELERÍA /
ICE-CREAM UTENSILS & PASTRY /
USTENSILES À GLACE ET PÂTISSERIE /
ZUBEHÖR FÜR EISCREME UND PATISSERIE

Molde desmontable Antiadherente /
Non-stick spring form /

P723 Moule rond démontable /
Demontierbare Backform Antihaft



REF	Ø cm	H cm	
P723.024	24	7,0	1
P723.028	28	7,0	1

MOLDES ANTIADHERENTES / NON-STICK MOULDS /
MOULES ANTI-ADHÉSIFS/ ANTIHAFT BACKFORM

Molde para tarta /
High cake mould /

P703 Manqué rond uni /
Tortenbackform



REF	Ø cm	H cm	
P703.020	20	4,5	1
P703.024	24	5,0	1
P703.028	28	5,0	1
P703.032	32	5,5	1

Molde rizado para tarta /
Round tart mould with fluted edges /

P710 Tourtière ronde avec Bord cannelé /
Runde Ecken Tortenbackform



REF	Ø cm	H cm	
P710.020	20	2,5	1
P710.024	24	2,5	1
P710.028	28	2,5	1

Molde rizado fondo desmontable /
Fluted edge mould with removable base /

P711 Tourtière avec fond amovible /
Runde Ecken Backform Boden demontierbar



REF	Ø cm	H cm	
P711.010	10	1,8	1
P711.012	12	2,0	1
P711.020	20	2,5	6
P711.024	24	2,5	6
P711.028	28	2,5	6
P711.032	32	2,5	6

P708 Molde savarin / Savarin mould /
Moule savarin / Savarin Backform



REF	Ø cm	H cm	
P708.008	8	2,0	1
P708.022	22	4,5	1
P708.024	24	5,0	1

P712 Molde savarin "trois frères" /
"Trois frères" ring mould /
Moule savarin "trois frères" /
Savarin Backform "trois frères"



REF	Ø cm	H cm	
P712.022	22	5,5	6

P713 Molde ovalado para aspic /
Oval aspic mould /
Moule aspic ovale /
Ovale Backform für Aspic



REF	cm	H cm	
P713.075	7,5 x 5,5	3,8	6

P715 Molde redondo para bizcocho /
Baba mould /
Baba rond /
Baba Backform

Borde vuelto /
Rolled edge /
Bord roulé /
Gerollter Rand



REF	Ø cm	H cm	
P715.006	6,5	6,0	6

Ver productos en / See products on /
Voir produits en page / Siehe produktein

P.
310

MAQUINARIA /
MACHINERY /
MACHINES /
MASCHINEN



6.3

**HELADERÍA Y PASTELERÍA /
ICE-CREAM UTENSILS & PASTRY /
USTENSILES À GLACE ET PÂTISSERIE /
ZUBEHÖR FÜR EISCREME UND PATISSERIE**

**Molde barquita lisa /
Plain oval boat mould /**

P717 Moule Barquette unie /
Glatte Schiffchenbackform



REF	cm	H cm	
P717.008	8 x 3,3	1,2	6
P717.010	10 x 4,3	1,3	6

**MOLDES ANTIADHERENTES / NON-STICK MOULDS /
MOULES ANTI-ADHÉSIFS/ ANTIHAFT BACKFORM**

Molde madalenas con 10 costados /

10 Wide ribs brioche mould /

P718 Moule brioche 10 côtes /
Madeleinenbackform 10 Rundungen



Ø 6: 9 costados. Resto ø: 10 costados / Ø 6: 9 ribs. Other ø: 10 ribs /
Ø 6: 9 côtes. Autres ø: 10 côtes / Ø 6: 9 Rundungen. Resto ø: 10 Rundungen

REF	Ø cm	H cm	
P718.006	6	2,5	6
P718.008	8	3,2	6
P718.010	10	3,8	6
P718.011	11	4,0	6

Molde tartaleta acanalada redonda /

Round fluted tart mould /

P720 Moule tartelette ronde cannelée /
Törtchenbackform mit runden Ecken



REF	Ø cm	H cm	
P720.005	5	1,2	6
P720.006	6	1,2	6
P720.007	7	1,2	6
P720.008	8	1,2	6
P720.010	10	1,8	6
P720.012	12	2,0	6

Molde tartaleta redonda lisa /

Round plain tart mould /

P721 Moule tartelette ronde unie /
Glatte runde Törtchenbackform



REF	Ø cm	H cm	
P721.005	5	1,2	6
P721.006	6	1,2	6
P721.007	7	1,2	6
P721.008	8	1,2	6
P721.010	10	1,2	6

Caja de 60 pequeños moldes "Petits

Fours" / 60 "Petits fours" moulds set /

P722 Boîte de 60 "petits fours" / Kisten mit 60
Kleinen Backformen "Petits fours"



5 Piezas de cada uno de los 12 "Petits fours".
5 Pieces of each 12 "Petits fours".
5 Piècesde chacun des 12 "Petits fours".
5 Teile von jeden 12 "Petits fours".

REF	
P722.000	1

**Ver productos en / See products on /
Voir produits en page / Siehe produktein**

**P.
144**

JARRAS DE MEDIDAS /

MEASURING JUGS /

POTS MESUREURS /

MESSBECHER





P732

Caja de 8 cortapastas redondos lisos /
Set of 8 round plain cutters /
Boîte de 8 découpoirs ronds unis /
Kiste mit 8 runden glatten Teigusstechformen

INOX - ST/STEEL
EDELSTAHL



REF	Ø cm	H cm	
P732.000	3 / 4 / 5 / 6 / 7 / 8 / 9 / 10	3,5	1

P733

Caja de 8 cortapastas redondos rizados /
Set of 8 round fluted cutters /
Boîte de 8 découpoirs ronds cannelés /
Kiste mit 8 Teigusstechformen mit runden Ecken

INOX - ST/STEEL
EDELSTAHL



REF	Ø cm	H cm	
P733.000	3 / 4 / 5 / 6 / 7 / 8 / 9 / 10	3,5	1

P796

Caja 9 cortapastas redondos lisos poliglas /
9 pcs set polyglass plain cutters /
Boîte 9 découpoirs ronds unis polyglass /
Kiste mit 9 runden glatten Teigusstechformen Polyglas



REF	Ø cm	H cm	
P796.000	2 / 3 / 4 / 5 / 6 / 7 / 8 / 9 / 10	3,5	1

P7961

Caja 9 cortapastas redondos rizados poliglas /
9 pcs set polyglass fluted cutters /
Boîte 9 découpoirs ronds cannelés polyglass /
Kiste mit 9 Polyglas Teigusstechformen mit runden Ecken



REF	Ø cm	H cm	
P796.100	2 / 3 / 4 / 5 / 6 / 7 / 8 / 9 / 10	3,5	1

6.5 HELADERÍA Y PASTELERÍA /
ICE-CREAM UTENSILS & PASTRY /
USTENSILES À GLACE ET PÂTISSERIE /
ZUBEHÖR FÜR EISCREME UND PATISSERIE

MOLDES ACERO INOXIDABLE / ST/STEEL PASTRY MOULDS /
MOULES EN ACIERINOX / BACKFORMEN ROSTFREIER STAHL

P780 Aro redondo para tarta / Tart ring / Cercle à tarte / Runder Tortenring



REF	Ø cm	H cm	
P780.006	6	2,0	1
P780.008	8	2,0	1
P780.010	10	2,0	1

P781 Aro redondo para tarta / "Entremets" ring / Cercle à entremets / Runder Tortenring



REF	Ø cm	H cm	
P781.006	6	3,5	1
P781.008	8	3,5	1
P781.010	10	3,5	1

P785 Aro redondo para mousse / Mousse ring / Cercle à mousse / Runder Moussering



REF	Ø cm	H cm	
P785.006	6	4,0	1
P785.008	8	4,0	1
P785.010	10	4,0	1

P782 Aro redondo para mousse / Mousse ring / Cercle à mousse / Runder Moussering



REF	Ø cm	H cm	
P782.075	7,5	4,0	1
P782.008	8	4,5	1
P782.010	10	4,5	1
P782.012	12	4,5	1
P782.014	14	4,5	1
P782.016	16	4,5	1
P782.018	18	4,5	1
P782.020	20	4,5	1
P782.022	22	4,5	1
P782.024	24	4,5	1
P782.026	26	4,5	1
P782.028	28	4,5	1

P783 Aro redondo para tarta / Ice cream cake ring / Cercle à vacherin / Runder Tortenring



REF	Ø cm	H cm	
P783.006	6	6,0	1
P783.008	8	6,0	1
P783.010	10	6,0	1
P783.012	12	6,0	1
P783.014	14	6,0	1
P783.016	16	6,0	1
P783.018	18	6,0	1
P783.020	20	6,0	1
P783.022	22	6,0	1
P783.024	24	6,0	1
P783.026	26	6,0	1
P783.028	28	6,0	1
P783.030	30	6,0	1



Perfecto para presentación de platos /
Perfect for dishes presentation /
Idéal pour la présentation de plats /
Perfekt für die Tellerpräsentation

**HELADERÍA Y PASTELERÍA /
ICE-CREAM UTENSILS & PASTRY /
USTENSILES À GLACE ET PÂTISSERIE /
ZUBEHÖR FÜR EISCREME UND PATISSERIE**

**MOLDES ACERO INOXIDABLE / ST/STEEL PASTRY MOULDS /
MOULES EN ACIERINOX / BACKFORMEN ROSTFREIER STAHL**

**P765 Molde hexagonal / Hexagon /
Hexagone / Sechseckige Form**

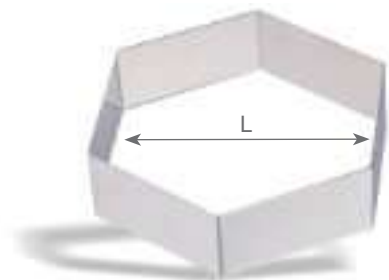

REF	L cm	H cm	
P765.020	20	4,5	1
P765.024	24	4,5	1

**P768 Molde forma lágrima / Tear /
Larme / Tränenform**



REF	L cm	H cm	
P768.006	6	4,5	1
P768.008	8	4,5	1

**P771 Molde forma oval / Oval /
Ovale / Ovalform**

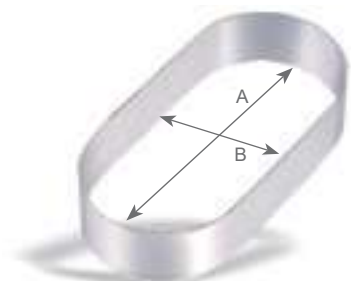

REF	L cm	H cm	
P771.025	25 x 11,2	4,5	1

**P769 Molde forma corazón / Heart /
Coeur / Herzform**

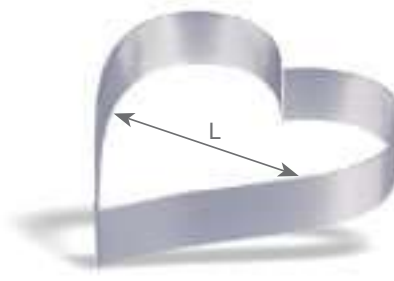

REF	L cm	H cm	
P769.008	8	4,5	1
P769.010	10	4,5	1
P769.018	18	4,5	1
P769.020	20	4,5	1
P769.022	22	4,5	1

P992 Cinta PVC para mousse / PVC ribbon for mousse / Ruban pâtissier en PVC / PVC Band für Mousse



REF	Longitud / Length / Longueur / Länge	H cm	
P992.040	100 m	4,0	1
P992.045	100 m	4,5	1
P992.050	100 m	5,0	1

Ver productos en / See products on / Voir produits en page / Siehe produkte in

P.
105

**PINZA CHEF PRECISIÓN /
FINE TIP STRAIGHT TWEEZER /
PINCE DU CHEF PRÉCISION /
PRÄZISIONSPINZETTE**



**6.5 HELADERÍA Y PASTELERÍA /
ICE-CREAM UTENSILS & PASTRY /
USTENSILES À GLACE ET PÂTISSERIE /
ZUBEHÖR FÜR EISCREME UND PATISSERIE**

**MOLDES ACERO INOXIDABLE / ST/STEEL PASTRY MOULDS /
MOULES EN ACIERINOX / BACKFORMEN ROSTFREIER STAHL**

P355 Flanero / Caramel cream mould / Moule à flan / Karamellcremeform

INOX - ST/STEEL
EDELSTAHL



REF	Ø cm	H cm	Lts	
P355.007	7,5	5,2	0,12	10
P355.008	8,5	5,4	0,17	10

**P136 Molde industrial para flan / Reinforced caramel cream mould /
Moule à flan / Industrielle Karamellcremeform**

**ALUMINIO /
ALUMINIUM**



REF	Ø cm	H cm	Lts	
P136.006	6	5,5	0,10	1
P136.007	7	6,5	0,15	1
P136.008	8	6,5	0,25	1

P784 Molde cake / Cake mould / Moule à cake / Kuchenbackform

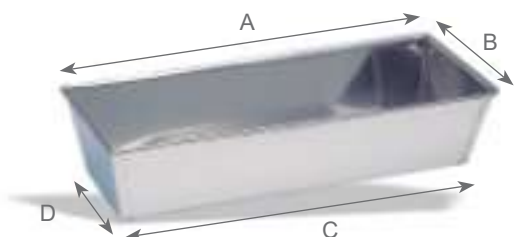

REF	A x B cm	C x D cm	H cm	
P784.020	20 x 13	18 x 10	8	1
P784.025	25 x 13	22 x 10	8	1
P784.030	30 x 13	27 x 10	8	1
P784.035	35 x 13	32 x 10	8	1
P784.040	40 x 13	36,5 x 10	8	1

**P788 Molde 1/2 caña desmontable triangular / Triangle cake mould /
Gouttière triangulaire / Dreieckige demontierbare Backform**



REF	cm	
P788.025	25 x 9 x 6	1
P788.050	50 x 9 x 6	1

**P789 Molde 1/2 caña desmontable redondo / Round cake mould /
Gouttière ronde / Halbrunde demontierbare Backform**



REF	cm	
P789.025	25 x 9 x 6	1
P789.050	50,5 x 9 x 9	1



PASTELERÍA /
PASTRY /
PÂTISSERIE

P800 Mangas de nylon / Nylon pastry bags / Poches pâtisseries en nylon / Nylon Spritzbeutel



REF	cm	Ø cm	
P800.030	30	17,0	6
P800.035	35	19,5	6
P800.040	40	22,0	6
P800.045	45	25,0	6
P800.050	50	27,5	6
P800.055	55	30,5	6
P800.060	60	33,0	6
P800.065	65	35,0	6
P800.070	70	39,0	6

Fabricadas en nylon y recubiertas de poliuretano por una cara. Impermeables y ultraligeras. Son muy cómodas de utilizar. Se pueden hervir. Sin costuras, termosoldadas de larga duración y con la punta ajustable /

Made in nylon and covered with polyurethane on one side. Waterproof, ultra light and very comfortable to use. Sterizable, without seams, thermowelded for long life and with an adjustable end /

Fabriquéés en tissu de nylon avec un revêtement polyuréthane sur une face. Impérmeables, très souples, ultralégères et très comodes au tact. Stérilisables, sans coutures, thermosoudées, de longue durée et avec l'embout ajustable /

Hergestellt aus Nylon und auf einer Seite mit Polyurethan beschichtet. Undurchlässig und ultraleicht. Sie sind sehr einfach zu benutzen. Sie lassen sich abkochen. Ohne Nähte, langlebige Hitzeverschweißung mit einer anpassbaren Spitze.

P851 Manga pastelera de algodón / Cotton pastry bag / Poches pâtisseries en coton / Baumwolle Spritzbeutel



REF	L cm	
P851.040	40	1
P851.046	46	1
P851.050	50	1

6.6 HELADERÍA Y PASTELERÍA /
ICE-CREAM UTENSILS & PASTRY /
USTENSILES À GLACE ET PÂTISSERIE /
ZUBEHÖR FÜR EISCREME UND PATISSERIE

MANGAS Y BOQUILLAS / BAGS AND TUBES /
POCHES ET DOUILLES / SPRITZBEUTEL UND TÜLLEN

P798 Mangas desechables / Disposable pastry bags / Poches jetables / Einweg Spritzbeutel



REF	cm	Lts	
P798.040	43	2,00	1
P798.055	55	3,50	1
P798.065	65	5,00	1

P798056 Mangas desechables color verde / Green disposable pastry bags /
Poches jetables vertes / Einweg-Spritzbeutelgrün

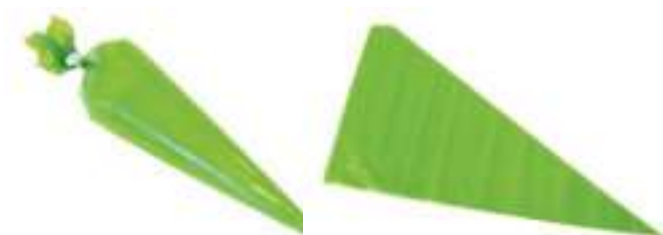

REF	cm	Lts	
P798.056	55	3,50	1

Caja de 100 unidades /
100 pieces set /
Boîte de 100 pièces /
Kiste von 100 Stück.

P849 Soporte para mangas pasteleras y boquillas / Support for pastry bags and tubes (nozzles) /
Support pour pochés pâtisseries et douilles / Ständer für Spritzbeutel und Tüllen



REF	
P849.000	1



Ver productos en / See products on / Voir produits en page / Siehe produkte in

P.
92



TAPETE DE SILICONA /
NON-STICK SILICONE MAT /
TOILE DE CUISSON /
SILIKONMATTE





P810 Boquilla redonda / Plain tube / Douille unie / Rundtülle

	Ø	REF	Ø mm	
		P810.004	4	25
		P810.006	6	25
		P810.008	8	25
		P810.010	10	25
		P810.012	12	25
		P810.014	14	25

P811 Boquilla estrella / Star tube / Douille cannelée / Sterntülle

	Ø	REF	Ø mm	Nº Puntas / Nº Teeth / Nº Dents / Nº Ecken	
		P811.004	4	6	25
		P811.006	6	6	25
		P811.008	8	6	25
		P811.010	10	7	25
		P811.012	12	7	25
		P811.014	14	8	25
		P811.016	16	9	25



P812 Boquilla estrella cerrada / Closed star tube / Douille cannelée fermée / Geschlossene Sterntülle

	Ø	REF	Ø mm	Nº Puntas / Nº Teeth / Nº Dents / Nº Ecken	
		P812.003	3	6	25
		P812.005	5	6	25
		P812.007	7	6	25
		P812.009	9	8	25
		P812.011	11	8	25



P813 Boquilla cinta estrella / Yule log tube / Douille à bûche de Noël / Sternbandtülle

		REF	mm	Nº Puntas / Nº Teeth / Nº Dents / Nº Ecken	
		P813.016	16 x 2	6	25
		P813.020	20 x 3	6	25

P816 Boquilla flor / Flower tube / Douille fleur / Blumentülle

	Ø	REF	Ø mm	Nº Puntas / Nº Teeth / Nº Dents / Nº Ecken	
		P816.011	11	6	25
		P816.015	15	9	25

P817 Boquilla flor cerrada / Closed flower tube / Douille fleur fermée / Geschlossene Blumentülle

	Ø	REF	Ø mm	Nº Puntas / Nº Teeth / Nº Dents / Nº Ecken	
		P817.005	5	6	25
		P817.006	6	8	25
		P817.008	8	9	25

**6.6 HELADERÍA Y PASTELERÍA /
ICE-CREAM UTENSILS & PASTRY /
USTENSILES À GLACE ET PÂTISSERIE /
ZUBEHÖR FÜR EISCREME UND PATISSERIE**

**MANGAS Y BOQUILLAS / BAGS AND TUBES /
POCHES/ETDOUILLES/ SPRITZBEUTEL UND TÜLLEN**

P815 Boquilla rizada / "petits fours" tube / Douille à "petits fours" / Tülle "petits fours"

REF	Ø mm	Nº Puntas / Nº Teeth / Nº Dents / Nº Ecken	
P815.006	6	9	25
P815.009	9	12	25
P815.012	12	15	25
P815.015	15	16	25

P814 Boquilla para relleno / Bismark tube / Douille petit chou / Fülltülle







REF	Ø mm	
P814.000	4	25

P820 Conjunto de 6 boquillas nº 0 / Set of 6 tubes nr. 0 / Boîte de 6 douilles num. 0 / Set von 6 Tüllen Nr. 0



REF	
P820.000	1

Los gráficos de los diámetros de los agujeros de salida de las boquillas son a tamaño real / Diameter exit holes of the tubes are drawn at real size.
Les graphiques des diamètres des embouts de sortie des douilles sont en taille réelle / Der abgebildete Durchmesser der Öffnungen entspricht der realen Grösse.







-  **1 Boquilla redonda 4 mm**
1 Plain tube 4 mm
1 Douille unie 4 mm
1 Rundtülle 4 mm
-  **1 Boquilla cinta estrella 20 x 3 mm**
1 Yule log 20 x 3 mm
1 Douille à bûche de Noël 20 x 3 mm
1 Sternbandtülle 20 x 3 mm
-  **1 Boquilla estrella 12 mm**
1 Star tube 12 mm
1 Douille cannelée 12 mm
1 Sterntülle 12 mm
-  **1 Boquilla estrella 8 mm**
1 Star tube 8 mm
1 Douille cannelée 8 mm
1 Sterntülle 8 mm
-  **1 Boquilla redonda 8 mm**
1 Plain tube 8 mm
1 Douille unie 8 mm
1 Rundtülle 8 mm
-  **1 Boquilla flor 11 mm**
1 Flower tube 11 mm
1 Douille fleur 11 mm
1 Blumentülle 11 mm

P821 Conjunto de 6 boquillas nº 1 / Set of 6 tubes nr. 1 / Boîte de 6 douilles num. 1 / Set von 6 Tüllen Nr. 1



REF	
P821.000	1

Los gráficos de los diámetros de los agujeros de salida de las boquillas son a tamaño real / Diameter exit holes of the tubes are drawn at real size.
Les graphiques des diamètres des embouts de sortie des douilles sont en taille réelle / Der abgebildete Durchmesser der Öffnungen entspricht der realen Grösse.

-  **1 Boquilla redonda 2 mm**
1 Plain tube 2 mm
1 Douille unie 2 mm
1 Rundtülle 2 mm
-  **1 Boquilla redonda 6 mm**
1 Plain tube 6 mm
1 Douille unie 6 mm
1 Rundtülle 6 mm
-  **1 Boquilla redonda 10 mm**
1 Plain tube 10 mm
1 Douille unie 10 mm
1 Rundtülle 10 mm
-  **1 Boquilla redonda 4 mm**
1 Plain tube 4 mm
1 Douille unie 4 mm
1 Rundtülle 4 mm
-  **1 Boquilla redonda 8 mm**
1 Plain tube 8 mm
1 Douille unie 8 mm
1 Rundtülle 8 mm
-  **1 Boquilla redonda 12 mm**
1 Plain tube 12 mm
1 Douille unie 12 mm
1 Rundtülle 12 mm

P822 Conjunto de 6 boquillas nº 2 / Set of 6 tubes nr. 2 /
Boîte de 6 douilles num. 2 / Set von 6 Tüllen Nr. 2



REF

P822.000



1

Los gráficos de los diámetros de los agujeros de salida de las boquillas son a tamaño real / Diameter exit holes of the tubes are drawn at real size.
Les graphiques des diamètres des embouts de sortie des douilles sont en taille réelle / Der abgebildete Durchmesser der Öffnungen entspricht der realen Größe.

★ **1 Boquilla estrella 2 mm**
1 Star tube 2 mm
1 Douille cannelée 2 mm
1 Sterntülle 2 mm

★ **1 Boquilla estrella 4 mm**
1 Star tube 4 mm
1 Douille cannelée 4 mm
1 Sterntülle 4 mm

★ **1 Boquilla estrella 6 mm**
1 Star tube 6 mm
1 Douille cannelée 6 mm
1 Sterntülle 6 mm

★ **1 Boquilla estrella 8 mm**
1 Star tube 8 mm
1 Douille cannelée 8 mm
1 Sterntülle 8 mm

★ **1 Boquilla estrella 10 mm**
1 Star tube 10 mm
1 Douille cannelée 10 mm
1 Sterntülle 10 mm

★ **1 Boquilla estrella 12 mm**
1 Star tube 12 mm
1 Douille cannelée 12 mm
1 Sterntülle 12 mm

P823 Conjunto de 6 boquillas nº 3 / Set of 6 tubes nr. 3 /
Boîte de 6 douilles num. 3 / Set von 6 Tüllen Nr. 3



REF

P823.000



1

Los gráficos de los diámetros de los agujeros de salida de las boquillas son a tamaño real / Diameter exit holes of the tubes are drawn at real size.
Les graphiques des diamètres des embouts de sortie des douilles sont en taille réelle / Der abgebildete Durchmesser der Öffnungen entspricht der realen Größe.

★ **1 Boquilla rizada 12 mm**
1 "Petits fours" tube 12 mm
1 Douille à "petits fours" 12 mm
1 Tülle "petits fours" 12 mm

★ **1 Boquilla flor 13 mm**
1 Flower tube 13 mm
1 Douille fleur 13 mm
1 Blumentülle 13 mm

★ **1 Boquilla estrella cerrada 7 mm**
1 Closed star tube 7 mm
1 Douille cannelée fermée 7 mm
1 Geschlossene Sterntülle 7 mm

★ **1 Boquilla flor cerrada 6 mm**
1 Closed flower tube 6 mm
1 Douille fleur fermée 6 mm
1 Geschlossene Blumentülle 6 mm

★ **1 Boquilla estrella 8 mm**
1 Star tube 8 mm
1 Douille cannelée 8 mm
1 Sterntülle 8 mm

★ **1 Boquilla redonda 10 mm**
1 Plain tube 10 mm
1 Douille unie 10 mm
1 Rundtülle 10 mm

P824 Conjunto de 12 boquillas nº 4 / Set of 12 tubes nr. 4 /
Boîte de 12 douilles num. 4 / Set von 12 Tüllen Nr. 4



REF

P824.000



1

Los gráficos de los diámetros de los agujeros de salida de las boquillas son a tamaño real / Diameter exit holes of the tubes are drawn at real size.
Les graphiques des diamètres des embouts de sortie des douilles sont en taille réelle / Der abgebildete Durchmesser der Öffnungen entspricht der realen Größe.

● **1 Boquilla redonda 6 mm**
1 Plain tube 6 mm
1 Douille unie 6 mm
1 Rundtülle 6 mm

● **1 Boquilla redonda 10 mm**
1 Plain tube 10 mm
1 Douille unie 10 mm
1 Rundtülle 10 mm

★ **1 Boquilla estrella 8 mm**
1 Star tube 8 mm
1 Douille cannelée 8 mm
1 Sterntülle 8 mm

★ **1 Boquilla estrella 12 mm**
1 Star tube 12 mm
1 Douille cannelée 12 mm
1 Sterntülle 12 mm

★ **1 Boquilla estrella cerrada 7 mm**
1 Closed star tube 7 mm
1 Douille cannelée fermée 7 mm
1 Geschlossene Sterntülle 7 mm

★ **1 Boquilla estrella cerrada 11 mm**
1 Closed star tube 11 mm
1 Douille cannelée fermée 11 mm
1 Geschlossene Sterntülle 11 mm

★ **1 Boquilla cinta estrella 20 mm**
1 Yule log tube 20 mm
1 Douille à bûche de Noël 20 mm
1 Sternbandtülle 20 mm

★ **1 Boquilla rizada 9 mm**
1 "Petits fours" tube 9 mm
1 Douille à "petits fours" 9 mm
1 Tülle "petits fours" 9 mm

★ **1 Boquilla rizada 15 mm**
1 "Petits fours" tube 15 mm
1 Douille à "petits fours" 15 mm
1 Tülle "petits fours" 15 mm

★ **1 Boquilla flor 11 mm**
1 Flower tube 11 mm
1 Douille fleur 11 mm
1 Blumentülle 11 mm

★ **1 Boquilla flor 15 mm**
1 Flower tube 15 mm
1 Douille fleur 15 mm
1 Blumentülle 15 mm

★ **1 Boquilla flor cerrada 8 mm**
1 Closed flower tube 8 mm
1 Douille fleur fermée 8 mm
1 Geschlossene Blumentülle 8 mm

6.6 HELADERÍA Y PASTELERÍA / ICE-CREAM UTENSILS & PASTRY / USTENSILES À GLACE ET PÂTISSERIE / ZUBEHÖR FÜR EISCREME UND PATISSERIE

MANGAS Y BOQUILLAS / BAGS AND TUBES / POCHES/ETDOUILLES/ SPRITZBEUTEL UND TÜLLEN

P853 Boquilla redonda de policarbonato / Polycarbonate plain tube / Douille unie en polycarbonate / Rundtülle Polycarbonat



REF	Ø mm	Num.	
P853.004	4	0	1
P853.006	6	2	1
P853.008	8	4	1
P853.010	10	6	1
P853.012	12	8	1
P853.014	14	10	1

P854 Boquilla estrella de policarbonato / Polycarbonate star tube / Douille cannelée en polycarbonate / Sterntülle Polycarbonat



REF	Ø cm	Nº Puntas / Nº Teeth / Nº Dents / Nº Ecken	Num.	
P854.006	6	7	2	1
P854.008	8	7	4	1
P854.010	10	7	6	1
P854.012	12	7	8	1
P854.014	14	8	10	1
P854.016	16	8	12	1

P855 Conjunto de 6 boquillas de policarbonato nº 5 / Set of 6 polycarbonate tubes nº 5 / Boîte de 6 douilles en polycarbonate nº 5 / Set von 6 Tüllen PolycarbonatNr. 5

Boquilla redonda
Plain tube
Douille unie
Rundtülle



REF	
P855.000	1

Nº 0 4 mm	Nº 2 6 mm	Nº 4 8 mm	Nº 6 10 mm	Nº 8 12 mm	Nº 10 14 mm

P856 Conjunto de 6 boquillas de policarbonato nº 6 / Set of 6 polycarbonate tubes nº 6 / Boîte de 6 douilles en polycarbonate nº 6 / Set von 6 Tüllen PolycarbonatNr. 6

Boquilla estrella
Star tube
Douille cannelée
Sterntülle



REF	
P856.000	1

Nº 2 6 mm	Nº 4 8 mm	Nº 6 10 mm	Nº 8 12 mm	Nº 10 14 mm	Nº 12 16 mm

P857 Conjunto de 12 boquillas de policarbonato nº 12 / Set of 12 polycarbonate tubes nº 12 / Boîte de 12 douilles en polycarbonate nº 12 / Set von 12 Tüllen PolycarbonatNr. 12

Boquilla redonda
Plain tube
Douille unie
Rundtülle



REF	
P857.000	1

Boquilla estrella
Star tube
Douille cannelée
Sterntülle

Nº 2 6 mm	Nº 4 8 mm	Nº 6 10 mm	Nº 8 12 mm	Nº 10 14 mm	Nº 12 16 mm	Nº 0 4 mm	Nº 2 6 mm	Nº 4 8 mm	Nº 6 10 mm	Nº 8 12 mm	Nº 10 14 mm

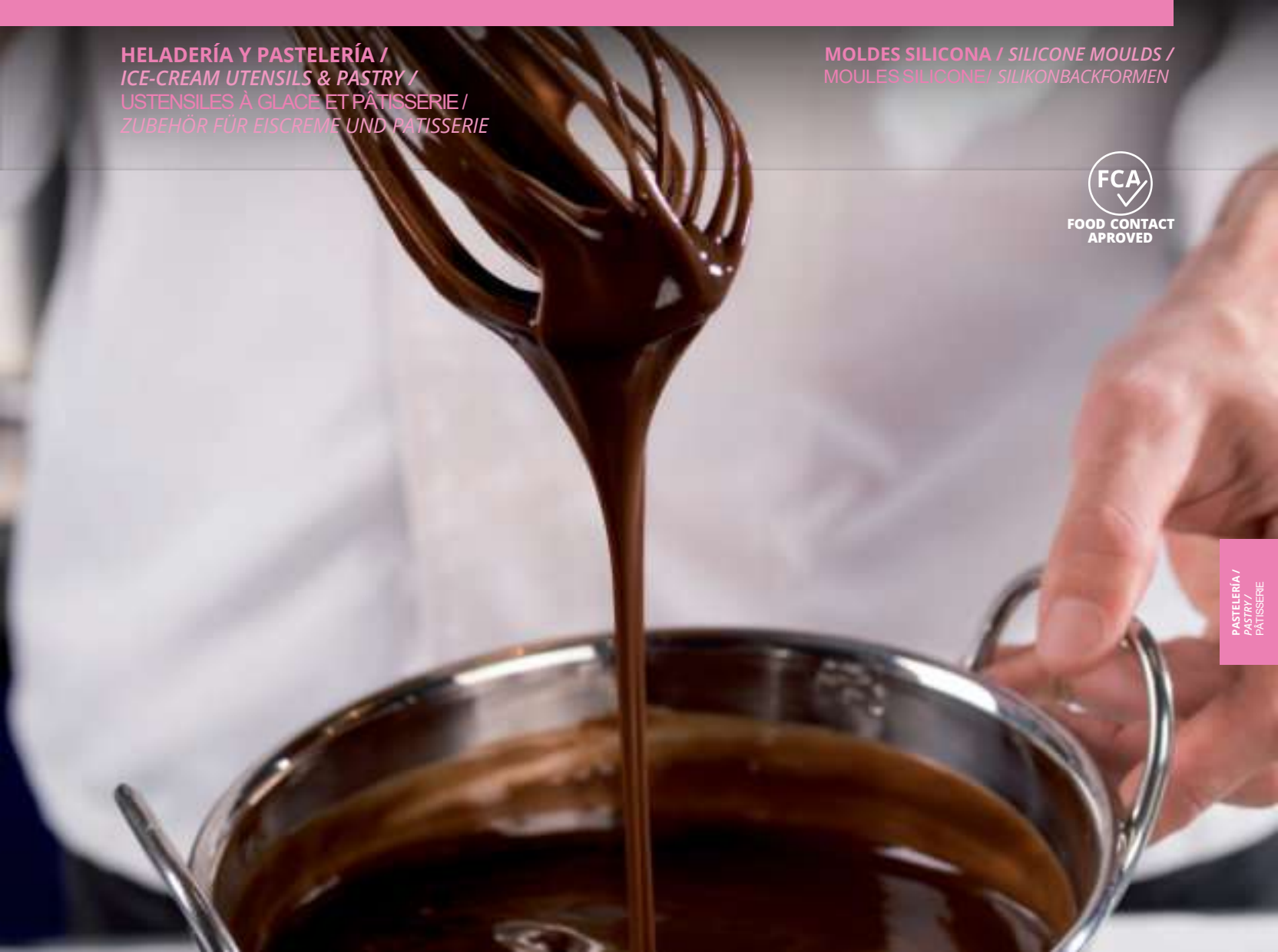

MEDIDAS /
SIZES /
MESURES /
GRÖSSEN

GN 1/3

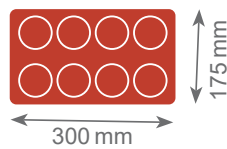

GN 1/1

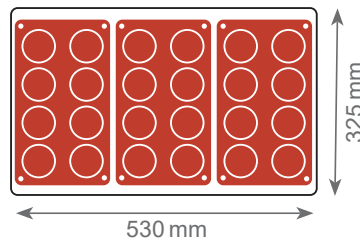

Pastelería / Pastry / Pâtisserie / Pâtisserie

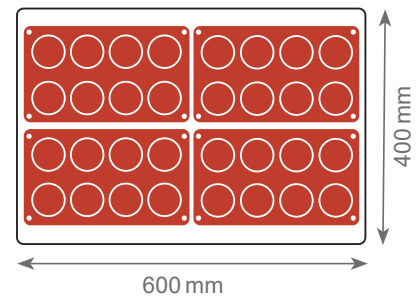

100%

SILICONA /
SILICONE /
SILICONE /
SILIKON

FLEXIBILIDAD /
FLEXIBILITY /
FLEXIBILITÉ /
FLEXIBILITÄT



Ideal para congelador. Puede ser utilizado para preparar todo tipo de pequeña repostería, galletas o chocolates.
I deal for freezing. It can also be used for all preparations of cakes, chocolates, petit-fours, and catering preparations.
Idéal pour la congélation. Utilisable pour tout type de préparations de cakes, chocolats, petits fours, et préparations traiteurs.
Ideal für den Gefrierschrank. Sie sind geeignet für alle Arten der Zubereitung von kleinen Nachspeisen, Keksen oder Schokoladen.

● -60 °C / -140 °F
● +230 °C / +446 °F



dishwasher



oven



gas



H.A.C.C.P.
NO PROBLEM

6.7

HELADERÍA Y PASTELERÍA / ICE-CREAM UTENSILS & PASTRY / USTENSILES À GLACE ET PÂTISSERIE / ZUBEHÖR FÜR EISCREME UND PATISSERIE

MOLDES SILICONA / SILICONE MOULDS / MOULES SILICONE/ SILIKONBACKFORMEN

MEDIA BOLA

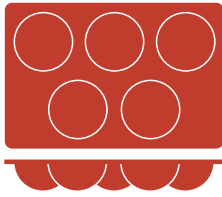

REF	Fig	Ø mm	H mm
P850.001	5 5	80	40

MEDIA BOLA

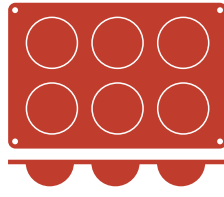

REF	Fig	Ø mm	H mm
P850.002	6 6	70	35

MEDIA BOLA

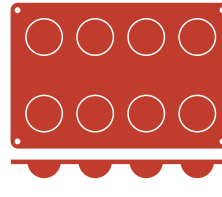

REF	Fig	Ø mm	H mm
P850.003	8 8	60	30

MEDIA BOLA

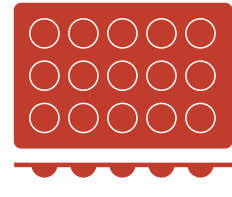

REF	Fig	Ø mm	H mm
P850.004	15 15	50	25

MEDIA BOLA

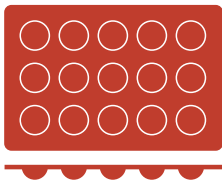

REF	Fig	Ø mm	H mm
P850.005	15 15	40	20

MEDIA BOLA

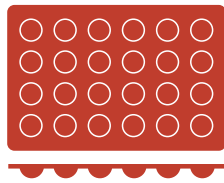

REF	Fig	Ø mm	H mm
P850.006	24 24	30	15

PIRAMIDE



REF	Fig	Ø mm	H mm
P850.007	6 6	71 x 71	40

SAVARIN



REF	Fig	Ø mm	H mm
P850.012	6 6	72	23

OVAL

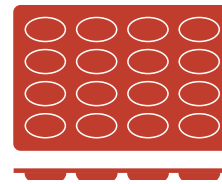

REF	Fig	Ø mm	H mm
P850.017	24 24	30	15

OVAL

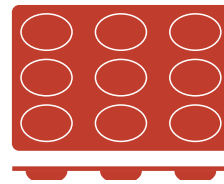

REF	Fig	Ø mm	H mm
P850.018	9 9	70 x 50	20

MUFFIN

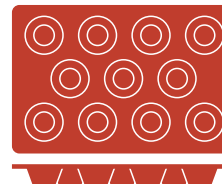

REF	Fig	Ø mm	H mm
P850.022	11 11	50	28

MUFFIN



REF	Fig	Ø mm	H mm
P850.023	6 6	70	37

MUFFIN

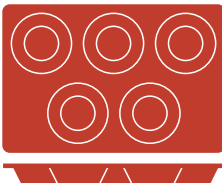

REF	Fig	Ø mm	H mm
P850.024	5 5	80	35

CAKE

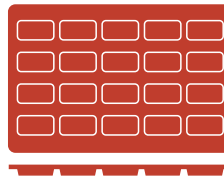

REF	Fig	Ø mm	H mm
P850.025	20 20	49 x 26	11

CAKE

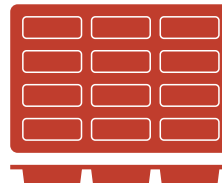

REF	Fig	Ø mm	H mm
P850.026	12 12	80 x 30	30

PETIT FOUR

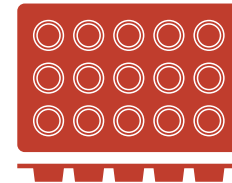

REF	Fig	Ø mm	H mm
P850.027	15 15	40	20

CILINDRO

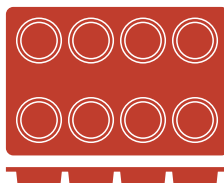

REF	Fig	Ø mm	H mm
P850.028	8 8	60	35

MADALENA

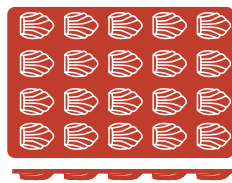

REF	Fig	Ø mm	H mm
P850.031	20 20	38 x 30	10

BORDELAIS

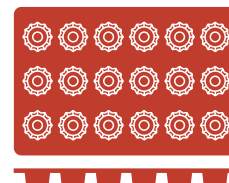

REF	Fig	Ø mm	H mm
P850.033	18 18	35	35

P8504 Molde cake / Cake mould / Moule à cake / Kuchenbackform



REF	cm	
P850.424	24 x 10,5 x 6,5	1
P850.426	26 x 10 x 7	1

P8501 Molde tarta / High cake mould / Manqué rond uni / Tortenbackform



REF	Ø cm	H cm	
P850.124	24	4,2	1
P850.128	28	4,7	1

P8502 Molde savarin alto / Gugelhoph / Moule savarin haut / Hohe Savarinbackform



REF	Ø cm	H cm	
P850.222	22,5	11,5	1

Nueva forma
New shape
Nouvelle forme
Neue Form

P8505 Molde rizado para tarta / Round tart mould with fluted edges /
Tourtière ronde avec bord cannelé / Tortenbackform mit runden Ecken



REF	Ø cm	H cm	
P850.528	28	3,0	1

Nueva forma
New shape
Nouvelle forme
Neue Form

P8506 Flanero rizado / Brioche mould / Moule à brioche / Briochebackform



REF	Ø cm	H cm	
P850.614	14	5,0	1

6.7

HELADERÍA Y PASTELERÍA /
ICE-CREAM UTENSILS & PASTRY /
USTENSILES À GLACE ET PÂTISSERIE /
ZUBEHÖR FÜR EISCREME UND PATISSERIE

MOLDES SILICONA / SILICONE MOULDS /
MOULES SILICONE/ SILIKONBACKFORMEN

Moldes de silicona 600 x 400 mm Ofrecen la posibilidad de dividirlos en 2 moldes de 300 x 200 mm gracias a su diseño simétrico /
Silicone moulds 600 x 400 mm. Possible to divide in two of 300 x 200 mm thanks to its symmetrical design /
Moules en silicone 600 x 400 mm avec possibilité de diviser en deux moules de 300 x 200 mm grâce à sa symetrie /
Silikonformen 600 x 400 mm. Dank seinem symetrischen Design können sie in zwei Formen von 300 x 200 mm geteilt werden.

P859900 Mini-cakes / Mini-cakes / Mini-cakes / Minikuchen



600 x 400 mm

REF	Fig	mm1	mm2	H mm	
P859.900	20	100 x 50	80 x 30	30	1

P859901 Briochette



600 x 400 mm

REF	Fig	Ø mm	H mm	
P859.901	24	79	37	1

P859902 Semi-esferas / Half-spheres / Demi-sphères / Halbkugeln



600 x 400 mm

REF	Fig	Ø mm	H mm	
P859.902	24	70	35	1

P859903 Muffin



600 x 400 mm

REF	Fig	Ø mm	H mm	
P859.903	24	70	42	1

P859904 Mini muffin



600 x 400 mm

REF	Fig	Ø mm	H mm	
P859.904	20	50	28	1

P859905 Gugelhopf



600 x 400 mm

REF	Fig	Ø mm	H mm	
P859.905	24	70	36	1

P859906 Savarin



600 x 400 mm

REF	Fig	Ø mm	H mm	
P859.906	24	72	23	1

P859907 Mini madalenas / Mini madeleines / Mini madeleines / Minimadeleines



600 x 400 mm

REF	Fig	mm	H mm	
P859.907	84	42 x 30	11	1

P859908 Tartaletas / Tartalets / Tartalettes / Törtchen



600 x 400 mm

REF	Fig	Ø mm	H mm	
P859.908	60	50	15	1

P859909 Canalados / Cannelés



600 x 400 mm

REF	Fig	Ø mm	H mm	
P859.909	60	85	50	1

P859910 Piramides / Pyramids / Pyramides / Pyramiden



600 x 400 mm

REF	Fig	mm	H mm	
P859.910	30	71 x 71	40	1

P859911 Florentinas / Florentiners / Florentins / Florentiner



600 x 400 mm

REF	Fig	Ø mm	H mm	
P859.911	40	55	12	1

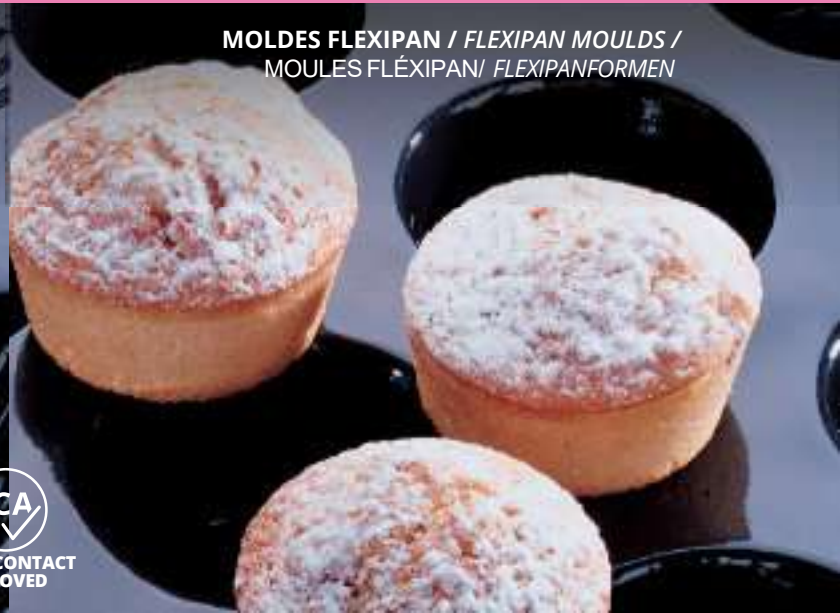

FLEXIPAN® ORIGINE



El Flexipan® es una combinación de fibras de vidrio y silicona adecuadas para el uso alimentario. Esta combinación de materiales le da a la pieza una solidez y duración de vida inigualables, así como propiedades anti-adherentes excepcionales tanto en cocción como en congelación. El Flexipan® no requiere ser engrasado ya que su composición y flexibilidad permiten un desmoldeo fácil y rápido. El Flexipan® con un uso y trato correctos nos permite realizar entre 2.000 y 3.000 cocciones antes de empezar a notar los primeros signos de deterioro. El Flexipan® permite realizar cualquier tipo de preparaciones dulces o saladas, tanto en cocción (+280 °C) como en congelación (-40 °C).

VENTAJAS FLEXIPAN®

- No es necesario engrasar los moldes para obtener un desmoldeo perfecto
- Gran facilidad para el desmoldeo de piezas congeladas
- La limpieza de los moldes se realiza de una manera fácil y rápida
- Larga vida de la pieza (2.000-3.000) cocciones
- Medidas para pastelería profesional (60x40 cm)
- Gama completa de formas

Le Flexipan® est une combinaison de tissus de verre et silicones adéquats pour l'utilisation alimentaire. Cette combinaison de matériels donne au moule une solidité et une durabilité extraordinaire, alliées à des propriétés anti-adhérentes exceptionnelles tant en cuisson comme en congélation. Le Flexipan® n'a pas besoin d'être lubrifié puisque sa composition et flexibilité permettent un démoulage facile et rapide. Selon l'utilisation et l'entretien des moules, le Flexipan®, nous permet d'effectuer entre 2.000 et 3.000 cuissons avant de noter les premiers signes de collage. Le Flexipan® permet d'effectuer tous types de préparations sucrées ou salées, en cuisson (+ 280 °C) ou en congélation (-40 °C).

AVANTAGES FLEXIPAN®

- Ne précise d'aucun graissage pour un démoulage facile et rapide
- Facile à nettoyer
- De 2000 à 3000 cuissons par moule
- Mesures pour la pâtisserie professionnelle (60x40 cm)
- Large gamme de moules

The Flexipan® is a silicone and fibre glass combination mould suitable for the food contact. This material combination gives to the piece solidity and an extraordinary durability, allied with exceptional non-stick properties either for cooking and freezing. The Flexipan® does not require to be lubricated since their composition and flexibility allow an easy and fast release from the mould. According to the use and the maintenance, the Flexipan®, enable us to use them between 2000 and 3000 times before the first signs of sticking arise. The FLEXIPAN can be used to bake (+280 °C) or freeze (-40 °C) the most sweet and savoury products.

ADVANTAGES FLEXIPAN®

- No need to be greased for an easy and quick realise
- Easy to clean
- Between 2000 and 3000 times can be used
- Professional pastry measures (60x40 cm)
- Large range of moulds

Flexipan® ist eine Kombination aus Fiberglas und Silikon angepasst an die Lebensmittelverarbeitung. Diese Materialkombination gibt der Form sowohl eine Festigkeit und eine unvergleichliche Langlebigkeit, als auch antihafteigenschaften Während des Backens und der Einfrierung. Flexipan® braucht keine Einfettung aufgrund seiner zusammenstellung und erlaubt eine schnelle und einfache Ablösung von der form. Flexipan® bietet bei einem korrekten Gebrauch und Behandlung die realisierung zwischen 2.000 und 3.000 Backungen bevor man die ersten Verschleisserscheinungen bemerkt. Flexipan® erlaubt die Realisierung aller Arten der Zubereitung von nachspeisen sowohl beim Backen (+280 °C) als auch beim Einfrieren (-40 °C).

VORTEILE FLEXIPAN®

- Keine Einfettung nötig um ein perfektes Ablösen von der form zu erreichen
- Einfachste Ablösung der eingefrorenen Stücke von der form
- einfache und Schnelle Reinigung der Formen
- Langlebigkeit der Formen (2.000-3.000) Backungen
- Grösse für die professionelle Patisserie (60x40 cm)
- Grosse Produktvielfalt

**MEDIDAS /
SIZES /
MESURES /
GRÖSSEN**

**Pastelería / Pastry /
Pâtisserie / Patisserie**

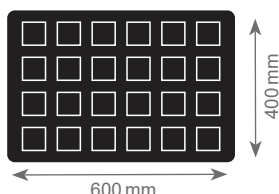



- 40 °C / - 104 °F
 + 280 °C / + 539 °F



**H.A.C.C.P.
NO PROBLEM**

Conos / Cones / Cones / Kegel





REF	Forma	Fig	Ø mm	H mm	ml	
P859.134		40	50	40,0	24	1
P859.135		20	70	60,0	80	1



Bavarois / Rosace shape / Bavarois / Bayerisch





REF	Forma	Fig	Ø mm	H mm	ml	
P859.139		18	78	35,0	100	1



Charlottes





REF	Forma	Fig	Ø mm	H mm	ml	
P859.141		24	62	35,0	60	1
P859.113		18	78	40,0	100	1



Magdalenas / Madeleines / Madeleines / Madeleines





REF	Forma	Fig	mm	H mm	ml	
P859.142		56	52 x 33	15,0	15	1
P859.115		40	78 x 47	19,0	35	1



Conchas / Saint Jacques shell / Coquilles Saint-Jacques / Jakobsmuscheln





REF	Forma	Fig	mm	H mm	ml	
P859.132		24	80 x 75	20,0	70	1



Margaritas / Deep flower / Marguerites en relief / Mageriten





REF	Forma	Fig	Ø mm	H mm	ml	
P859.143		24	24	27,0	70	1



Flores / Flowers / Fleurs / Blumen







REF	Forma	Fig	Ø mm	H mm	ml	
P859.144		24	78	20,0	80	1



Pirámides / Pyramids / Pyramides / Pyramiden









REF	Forma	Fig	mm	H mm	ml	
P859.109		54	35 x 35	23,0	15	1
P859.111		35	50 x 50	35,0	35	1
P859.110		24	71 x 71	41,0	90	1



Semi-esferas / Half-spheres / Demi-sphères / Halbkugeln



REF	Forma	Fig	mm	H mm	ml	
P859.151		96	26	16,0	6	1
P859.105		70	29	18,0	10	1
P859.103		48	42	21,0	20	1
P859.102		28	58	31,0	50	1
P859.101		24	70	40,0	105	1
P859.104		24	80	40,0	126	1



Semi-esferas invertidas / Half-spheres upside down / Demi-sphères inversées / Umgekehrte Halbkugeln



REF	Forma	Fig	mm	H mm	ml	
P859.150		45	26	16,0	6	1



Cuadrados / Squares / Carrés / Quadrate



REF	Forma	Fig	mm	H mm	ml	
P859.152		60	37 x 37	17,0	18	1
P859.153		35	56 x 56	24,0	60	1



Tartaletas cuadradas / Square tartlet / Tartelettes carrées / Quadratische Törtchen



REF	Forma	Fig	mm	H mm	ml	
P859.154		60	45 x 45	12,0	20	1
P859.155		40	60 x 60	15,0	40	1



PASTELERIA /
PASTRY /
PÂTISSERIE

Savarins cuadradas / Square savarins / Savarins carrées / Quadratische Savarine



REF	Forma	Fig	mm	H mm	ml	
P859.156		60	37 x 37	17,0	15	1
P859.157		35	56 x 56	24,0	45	1
P859.158		24	70 x 70	30,0	100	1



Savarins redondos / Round savarins / Savarins ronds / Runde Savarine



REF	Forma	Fig	mm	H mm	ml	
P859.159		60	41	12,0	10	1
P859.124		35	66	20,0	50	1
P859.219		24	70	23,0	65	1
P859.122		24	80	20,0	70	1



Savarins ovalados / Oval savarins / Savarins ovales / Ovale Savarine





REF	Forma	Fig	mm	H mm	ml	
P859.123		24	80 x 60	25,0	70	1



Óvalos / Oval / Ovales / Ovale







REF	Forma	Fig	mm	H mm	ml	
P859.167		30	70 x 50	30,0	75	1
P859.130		30	85 x 60	30,0	100	1



Tartaletas redondas / Round tartlets / Tartelettes ronds / Runde Törtchen







REF	Forma	Fig	mm	H mm	ml	
P859.114		60	42	10,0	13	1
P859.171		48	48	15,0	20	1
P859.172		40	58	20,0	35	1
P859.126		24	77	20,0	65	1



Troncos / Logs / Bûche / Blöcke



REF	Forma	Fig	mm	H mm	ml	
P859.125		24	95 x 40	30,0	80	1
P859.184		8	339 x 40	39,0	450	1
P859.185		5	495 x 40	39,0	700	1



Cakes/Bizcochos / Cakes-Lady fingers / Cakes-Coudoirs / Kuchen/ Biskuit





REF	Forma	Fig	mm	H mm	ml	
P859.186		120	40 x 15	12,0	6	1



Lingotes / Lingots / Lingots / Barren



REF	Forma	Fig	mm	H mm	ml	
P859.189		24	100 x 40	25,0	70	1
P859.190		24	120 x 40	25,0	90	1



Semi-cilindros / Half-Cylindres / Demi-cylindres / Halbzylinder





REF	Forma	Fig	mm	H mm	ml	
P859.191		48	85 x 17	15,0	20	1



Cakes





REF	Forma	Fig	mm	H mm	ml	
P859.192		24	80 x 30	30,0	55	1
P859.195		16	110 x 60	25,0	105	1



Financiers







REF	Forma	Fig	mm	H mm	ml	
P859.196		84	50 x 26	11,0	10	1
P859.197		24	86 x 46	14,0	45	1



Muffins







REF	Forma	Fig	Ø mm	H mm	ml	
P859.106		40	51	29,0	45	1
P859.107		24	73	40,0	125	1
P859.198		15	82	50,0	220	1



Cilindros / Cylinders / Cylindres / Zylinder





REF	Forma	Fig	Ø mm	H mm	ml	
P859.206		48	40	20,0	25	1
P859.207		24	63	25,0	65	1
P859.117		24	63	35,0	90	1



Florentina / Florentiners / Florentins / Florentiner







REF	Forma	Fig	Ø mm	H mm	ml	
P859.129		15	102	20,0	140	1



Tartas tatin / Etatin apple tarts / Tartes tatin / Tatintorten





REF	Forma	Fig	Ø mm	H mm	ml	
P859.210		15	82	30,0	135	1
P859.211		12	100	35,0	245	1
P859.212		12	105	40,0	305	1



Entremets-Pizzas-Quiches / Round-Pizza-Quiches / Empreintes rondes-Pizza-Quiches / Vorspeise-pizza-Quiches



REF	Forma	Fig	Ø mm	H mm	ml	
P859.116		6	186	12,0	300	1



Lanzaderas / Mini-brioche / Navettes / Schiffchen





REF	Forma	Fig	mm	H mm	ml	
P859.200		48	70 x 30	10,0	15	1



Alargadas / Long / Longues / Lange





REF	Forma	Fig	mm	H mm	ml	
P859.201		24	130 x 48	18,0	80	1



Redondas / Rounds / Ronds / Runde





REF	Forma	Fig	Ø mm	H mm	ml	
P859.202		24	79	15,0	65	1



Flores / Flowers / Fleurs / Blumen





REF	Forma	Fig	mm	H mm	ml	
P859.203		24	62 x 49	26,0	60	1



PASTELERÍA /
PASTRY /
PÂTISSERIE

Acanalda / Cannelées / Cannelées / Runde Ecken



REF	Forma	Fig	Ø mm	H mm	ml	
P859.204		24	68	25,0	60	1
P859.205		24	78	30,0	105	1



Octágonos / Octagons / Octagones / Achtecke





REF	Forma	Fig	mm	H mm	ml	
P859.119		40	43 x 40	26,0	28	1



Pomponnettes / Pomponnettes / Pomponnettes / Pomponnettes



REF	Forma	Fig	Ø mm	H mm	ml	
P859.120		96	36	17,0	14	1





CUBETAS GASTRONORM /
GASTRONORM CONTAINERS /
BACS GASTRONORME /
GASTRONORM BEHÄLTER

7.1	INOX 18/10 / 18/10 ST/STEEL / INOX 18/10 / EDELSTAHL 18/10	198
7.2	COMPLEMENTOS GASTRONORM / GASTRONORM ACCESSORIES / ACCESSOIRESGASTRONORME / GASTRONORM ASSESSOIRES	202
7.3	CON FONDO DIFUSOR / WITH SANDWICH BOTTOM / AVEC FOND THERMO-DIFFUSEUR / MIT SANDWICHBODEN	203
7.4	POLICARBONATO / POLYCARBONATE / POLYCARBONATE/ POLYCARBONAT	204
7.5	SIN BISFENOL-A / BISPHENOL-A FREE / SANSBISPHÉNOL-A/ OHNE BISFENOL-A	206
7.6	POLIPROPILENO / POLYPROPYLENE / POLYPROPYLÈNE/ POLYPROPYLEN	208
7.7	VIOLET COLLECTION	210

CUBETAS GASTRONORM / GASTRONORM CONTAINERS / BACS GASTRONORME / GASTRONORM BEHÄLTER

Conforme a la norma en-631.2 Pujadas ofrece una de las gamas de cubetas gastronorm de fabricación propia más amplia del mercado.

According to en-631.2 Pujadas offers one of the most specialized ranges, in-house manufacturing, of gastronorm containers in the market.

Suivant la norme en-631.2 Pujadas propose une des gammes de bacs gastronorm de propre fabrication des plus spécialisés du marché.

Entsprechend der norm EN-631.2 bietet Pujadas aus eigener Herstellung eine der breitesten Produktpalette im handel an.

ACERO INOXIDABLE / ST/STEEL / ACIER INOXYDABLE / ROSTFREIER STAHL 18/10



Bordes reforzados / Reinforced edges / Bords renforcés / Verstärkte ränder

Geometría adaptada: + limpieza + capacidad / Radius specially designed for: + capacity + cleaning / Géométrie adaptée: + propreté + capacité / Radius speziell design: + Kapazität + Reinigung

POLICARBONATO / POLICARBONATO / POLYCARBONATE / POLYCARBONAT

**- 40 °C
+ 130 °C**

Bordes reforzados / Reinforced rims / Bords renforcés / Verstärkte ränder
Marcaje modelo cubeta / Container model / Type de bac / ModelMarkierung am BeHälter
Textura para evitar ralladas / Texturing corners to avoid scratching / Côtés granités pour éviter rayures / Struktur um verkratzungen zu verhindern



Mayor grosor / Thicker / Plus épais / Dicker

Graduación externa de capacidad / Graduations marked externally / Échelle de graduations à l'extérieur / Externe Skalierung des Fassungsvermögen

Características marcadas en el fondo / Main features marked on the base / Caracteristiques marqués au fond / Eigenschaften im Boden markiert

SIN BISFENOL-A / BISPHENOL-A FREE / SANS BISPHÉNOL-A / OHNE BISFENOL-A

**- 40 °C
+ 90 °C**



POLIPROPILENO / POLYPROPYLENE / POLYPROPYLENE / POLYPROPYLEN

**- 40 °C
+ 110 °C**

Hermético con tapa Polinorm / Hermetic with Polinorm Lid / Hermetique avec couvercle Polinorm / Hermetisch mit polinorm Deckel
Bordes reforzados / Reinforced rims / Bords renforcés / Verstärkte ränder
Marcaje modelo cubeta / Container model / Type de bac / ModelMarkierung am BeHälter
Textura para evitar ralladas / Texturing corners to avoid scratching / Côtés granités pour éviter rayures / Struktur um Kratzer zu verhindern



Mayor grosor / Thicker / Plus épais / Dicker

Graduación externa de capacidad / Graduations marked externally / Échelle de graduations à l'extérieur / Externe Skalierung des Fassungsvermögen

Características marcadas en el fondo / Main features marked on the base / Caracteristiques marqués au fond / Eigenschaften im Boden markiert

**COCCIÓN /
COOKING /
CUISSON /
KOCHEN**

PATENTED EXCLUSIVE



**GN con fondo difusor /
GN Pan with sandwich base /
Bac GN avec fond thermo-diffuseur /
GN Backform mit Sandwichboden**



**GN aluminio antiadherente /
Non-stick aluminium GN pan /
Bac GN anti-adhésif en aluminium /
GN backform aluminium antihaft**



**Bandejas GN especial horno /
Special Oven GN pans /
PLAQUESpéciales GN pour four /
Spezielle GN Ofenformen**

**TRANSPORTE /
TRANSPORT /
TRANSPORT /
TRANSPORT**



**GN Inox + Tapa inox hermética /
St/Steel GN + St/Steel hermetic lid /
Bac GN Inox + Couvercle étanche inox /
GN Edelstahl + edelstahldeckel hermetisch**

TEMP. 120°C
HERMÉTICO / HERMETIC / ÉTANCHE / HERMETISCH



**Polycarbonato o cubeta sin Bisfenol-A + tapa polinorm /
Polycarbonate or BPA free + Polinorm lid /
Polycarbonate ou sans BPA + couvercle Polinorm /
Polycarbonat oder ohne bisfenol-A behälter + polinormDeckel**

TEMP. 100°C



**GN Polipropileno + Tapa Polinorm® /
Polypropylene + Polinorm® Lid /
GN Polypropylène + Couvercle Polinorm® /
GN Polipropilen + Polinorm® Deckel**

TEMP. 90°C

**ALMACENAMIENTO /
STORAGE /
STOCKAGE /
LAGERUNG**



**GN Polycarbonato + Tapa polycarbonato /
Polycarbonate GN + Polycarbonate Lid /
GN Polycarbonate + Couvercle Polycarbonate /
GN Polycarbonat + Polycarbonat Deckel**



**GN Polycarbonato + Tapa Polinorm® /
Polycarbonate GN + Polinorm® Lid /
Polycarbonate + Couvercle Polinorm® /
GN Polycarbonat + Polinorm® Deckel**



**GN Polipropileno + Tapa Polinorm® /
Polypropylene + Polinorm® Lid /
GN Polypropylène + Couvercle Polinorm® /
GN Polypropylen + Polinorm® Deckel**

V I O L E T

C O L L E C T I O N



**Antialérgico /
Allergen-Free /
Anti allergique /
Anti allergie**

**PRESENTACIÓN /
DISPLAY /
PRÉSENTATION /
PRÄSENTATION**



**GN Polycarbonato + Tapa polycarbonato /
Polycarbonate GN + Polycarbonate Lid /
GN Polycarbonate + Couvercle Polycarbonate /
Polycarbonat GN + Polycarbonat deckel**



**GN Inox con fondo Difusor + Tapa polycarbonato /
St/Steel GN with sandwich base + Polycarbonate Lid /
GN Inox avec fond thermo-diffuseur + Polycarbonate /
Edelstahl GN mit sandwichboden + Polycarbonat Deckel**



**GN Melamina /
Melamine GN /
GN mélamine /
Melamin GN**

**P.
380**

7.1 SELECCIÓN CUBETAS GASTRONORM / GASTRONORM CONTAINERS SELECTION / SELECTIONBACSGASTRONORME/ AUSWAHLÜBERSICHT GASTRONORM BEHÄLTER











	P. 198 	P. 203 	P. 397	P. 84
PRESENTACIÓN / APPEARANCE / PRÉSENTATION / PRÄSENTATION	✓	●	●	●
RESISTENCIA / ROBUSTNESS / ROBUSTESSE / RESISTENZ	✓	✓	✓	●
ALMACENAMIENTO / STORAGE / STOCKAGE / LAGERUNG	✓	●	●	
BAÑO-MARIA / BAIN MARIE / BAIN-MARIE / WASSERBAD	✓	✓	✓	●
TEMPERATURA MAX / TEMPERATURE MAX / TEMPÉRATURE MAX. / MAX. TEMPERATUR	✓	✓	✓	✓
HORNO / OVEN / FOUR / OFEN	✓	✓	✓	✓
MICROONDAS / MICRO-WAVE / MICRO-ONDES / MIKROWELLE				
COCCIÓN / COOKING / CUISSON / KOCHEN	●	✓	✓	✓
INDUCCIÓN / INDUCTION / INDUCTION / INDUKTION				
TRANSPORTE EN CALIENTE / WARM TRANSPORTATION / TRANSPORT CHAUD / WARMER TRANSPORT	✓	✓	✓	●
TAPA POLINORM / POLINORM LID / COUVERCLEPOLINORM / POLINORM DECKEL	✓	✓	✓	

✓ **RECOMENDADO / RECOMMENDED / RECOMMANDÉ / EMPFOHLEN**

● **ACEPTABLE / SUITABLE / ACCEPTABLE / ANNEHMBAR**

**SELECCIÓN CUBETAS GASTRONORM / GASTRONORM CONTAINERS SELECTION /
SELECTIONBACSGASTRONORME/ AUSWAHLÜBERSICHT GASTRONORM BEHÄLTER**

POLICARBONATO / POLYCARBONATE / POLYCARBONATE / POLYCARBONAT	SIN BISFENOL-A / BISPHENOL-A FREE / SANS BISPHÉNOL-A / OHNE BISFENOL-A	POLIPROPILENO / POLYPROPYLENE / POLYPROPYLENE / POLYPROPYLEN VIOLET COLLECTION	MELAMINA* / MELAMINE* / MÉLAMINE* / MELAMIN*
			
P. 204	P. 206	P. 208	P. 380
			
			
			
			
130 °C	90 °C	110 °C	70 °C
130 °C			
			
130 °C	80 °C		70 °C
			



CUBETAS GN / GN CONTAINERS / BACS GN

* AMBIENTE HÚMEDO / HUMID ENVIRONMENT / ENVIRONNEMENT HUMIDE / FEUCHTE UMGEBUNG

Combinaciones / Combinations / Combinaisons / Kombinationen



Medidas de encaste / Fitting measures / Mesures d'emboîtement / Masse der einsetzlöcher

Modelo	"A"	"B"
2/1	630	510
1/1	510	305
2/3	333	305
1/2	305	245
1/3	305	155
1/4	245	142
1/6	156	142
1/9	156	88

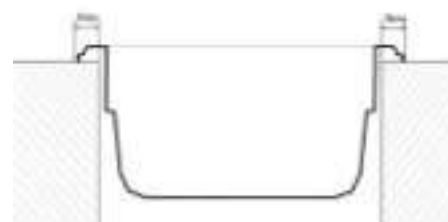
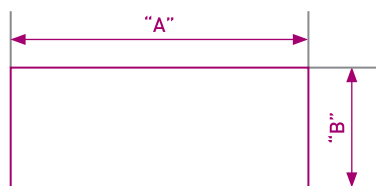

TAPA GN POLINORM®
GN POLYNORM® LID /
GN COUVERCLEPOLYNORM® /
GN POLYNORM® DECKEL



PATENTED EXCLUSIVE

DISPONIBLE EN CUATRO COLORES / AVAILABLE IN FOUR COLOURS /
DISPONIBLE EN QUATRE COULEURS/ VERFÜGBAR IN VIER FARBEN



CUBETAS GN /
GN CONTAINERS /
BACS GN

ADAPTABLES A / ADJUSTABLES TO / ADAPTABLEÀ / PASSEND ZU



Tapa Polinorm /
Polinorm Lid /
Couvercle Polinorm /
Polinorm Deckel

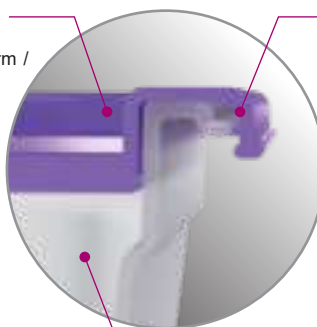

Clips para cierre cubeta inox y PC /
Flaps to fit with GN inox and PC /
Rainures pour clipser bacs GN inox et PC /
Verschlussklemme für Edelstahl und pc Behälter

Cubeta inox / Policarbonato /
Steel container / Polycarbonate /
Bacinox / Polycarbonate /
Edelstahl / Polycarbonat behälter

Tapa Polinorm /
Polinorm Lid /
Couvercle Polinorm /
Polinorm Deckel

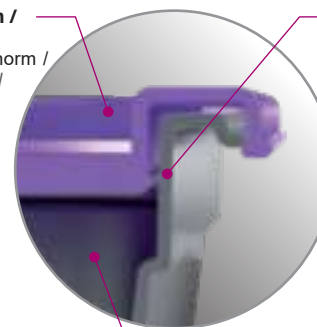

Cierre hermético para cubetas de PP /
Hermetical for PP containers /
Hermetique sur bacs PP /
Hermetischer Verschluss für behälter aus PP

Cubeta polipropileno /
Container polypropylene /
Bac polypropylène /
Polypropylen behälter

7.1 CUBETAS GASTRONORM / GASTRONORM CONTAINERS / BACSGASTRONORME/ GASTRONORM BEHÄLTER



GASTRONORM INOX 18/10 / 18/10 ST/STEEL GASTRONORM / GASTRONORME INOX 18/10 / GASTRONORM EDELSTAHL 18/10

2/1 650 x 530 mm

18/10



REF	H mm	Lts	
P210.201	20	6,20	6
P210.401	40	11,50	6
P210.651	65	18,80	6
P211.001	100	28,90	6
P211.501	150	43,10	3
P212.001	200	52,00	3

1/1 530 x 325 mm

18/10



REF	H mm	Lts	
P110.201	20	2,80	6
P110.401	40	5,10	6
P110.551	55	7,00	6
P110.651	65	8,30	6
P111.001	100	14,20	6
P111.501	150	20,20	6
P112.001	200	26,00	6

2/3 353 x 325 mm

18/10



REF	H mm	Lts	
P230.201	20	1,70	6
P230.401	40	3,10	6
P230.651	65	5,60	6
P231.001	100	8,80	6
P231.501	150	13,20	6
P232.001	200	18,30	6

1/2 325 x 265 mm

18/10

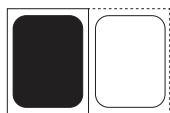

REF	H mm	Lts	
P120.201	20	1,20	6
P120.401	40	2,20	6
P120.651	65	4,10	6
P121.001	100	6,10	6
P121.501	150	9,10	6
P122.001	200	12,00	6

2/4 530 x 162 mm

18/10



REF	H mm	Lts	
P240.401	40	1,80	6
P240.651	65	4,00	6
P241.001	100	6,00	6
P241.501	150	10,00	6

1/3 325 x 176 mm

18/10



REF	H mm	Lts	
P130.201	20	0,80	6
P130.401*	40	1,50	6
P130.651	65	2,50	6
P131.001	100	3,80	6
P131.501	150	5,60	6
P132.001	200	7,30	6



* Cubeta GN especial para vitrinas mostrador snack.
 * Special GN container for snack showcases.
 * Bac GN spécial pour vitrines snack.
 * Spezial GN Behälter für Snackglasvitrinen

1/4 265 x 162 mm

18/10

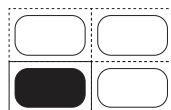

REF	H mm	Lts	
P140.201	20	0,50	6
P140.651	65	1,70	6
P141.001	100	2,80	6
P141.501	150	4,10	6
P142.001	200	5,00	6

1/6 176 x 162 mm

18/10

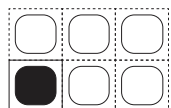

REF	H mm	Lts	
P160.651	65	1,00	6
P161.001	100	1,60	6
P161.501	150	2,20	6
P162.001	200	2,90	6

1/9 176 x 108 mm

18/10

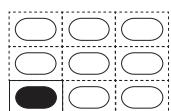

REF	H mm	Lts	
P190.651	65	0,60	6
P191.001	100	0,80	6

Fondos perforados para cubetas / Perforated bottoms for containers / Egouttoirs pour bacs / Gelochte Böden für Behälter



Aptos para cubetas SP3 hasta 100 mm de profundidad
Adjustable to SP3 upto 100 mm depth
Adaptables à bacs SP3 jusqu'à 100 mm profondeur
Geeignet für Behälter SP3 bis 100 mm tief



REF	Mod	
P215.000	2/1	1
P115.000	1/1	1
P235.000	2/3	1
P125.000	1/2	1
P135.000	1/3	1
P145.000	1/4	1

Perfiles divisorios / Adaptable bars / Barrettes de composition / Profilstege



REF	H mm	L cm	
P111.111	1/1	53,0	1
P122.222	1/2	32,5	1

Para realizar cualquier composición con las cubetas gastronorm.
To arrange any composition with gastronorm containers.
Pour réaliser toute composition avec les bacs gastronorme.
Für die Realisierung aller Kombinationen mit den GN Behälter.

Asas móviles / Falling handles / Anses tombantes / Fallgriffe

Apta para todas las medidas de cubetas
Suitable for all GN sizes
Apte sur toutes les dimensions GN
Einsetzbar an alle Grössen der Behälter



1

Asas fijas / Fixed handles / Anses fixes / Feste Griffe

Sólo para cubetas 1/2, 1/3, 1/4 y 1/6
Only for containers 1/2, 1/3, 1/4 and 1/6
Seulement pour bacs 1/2, 1/3, 1/4 et 1/6
Nur für Behälter 1/2, 1/3, 1/4 und 1/6



1

2/1 650 x 530 mm

18/10

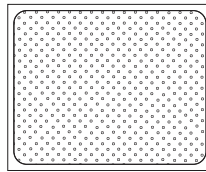

REF	H mm	
P210.202	20*	6
P210.402	40*	6
P210.652	65*	6
P211.002	100**	6
P211.502	150**	3
P212.002	200**	3

1/1 530 x 325 mm

18/10

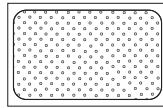

REF	H mm	
P110.202	20*	6
P110.402	40*	6
P110.552	55*	6
P110.652	65*	6
P111.002	100**	6
P111.502	150**	6
P112.002	200**	6

2/3 353 x 325 mm

18/10

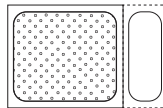

REF	H mm	
P230.202	20*	6
P230.402	40*	6
P230.652	65*	6
P231.002	100**	6
P231.502	150**	6
P232.002	200**	6

1/2 325 x 265 mm

18/10

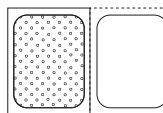

REF	H mm	
P120.652	65*	6
P121.002	100**	6
P121.502	150**	6
P122.002	200**	6

1/3 325 x 176 mm

18/10

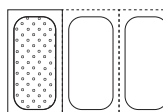

REF	H mm	
P130.202	20*	6
P130.402	40*	6
P130.652	65*	6
P131.002	100**	6
P131.502	150**	6
P132.002	200**	6

* Fondo perforado
* Perforated bottom
* Fondperforé
* Gelochter Boden

** Fondo y laterales perforados
** Perforated bottom and sides
** Fondset latéraux perforés
** Boden und Seiten gelocht

Tapa Polinorm® / Polinorm® Lid / Couvercle Polinorm® / Polinorm® Deckel

PATENTED EXCLUSIVE

Cubetas GN inox, PC, sin Bisfenol-A y PP.
No aptas para la gama SP3 /

St/Steel, PC, Bisphenol-A FREE and PP GN contain-
ers. Not for SP3 range /

Bacs GN inox, PC, sans Bisphénol-A et PP.
Pas pour la gamme SP3 /

GN Behälter rostfrei, PC, ohne Bisfenol-A und PP.
Edelstahlbehälter GN, PC, ohne Bisphenol-A und PP.
Nicht geeignet für SP3

REF	Mod	
P110.0 + COLOR	1/1	30
P120.0 + COLOR	1/2	60
P130.0 + COLOR	1/3	30
P140.0 + COLOR	1/4	30
P160.0 + COLOR	1/6	60
P190.0 + COLOR	1/9	30



Ref. color tapa / Ref. colour lid /
Ref. couleur couvercle / Art.Nr. Deckelfarbe



P6 Disponible para 1/1, 1/2, 1/3 y 1/6 /
Available for 1/1, 1/2, 1/3 and 1/6 /
Disponible pour 1/1, 1/2, 1/3 et 1/6 /
Verfügbar für 1/1, 1/2, 1/3 und 1/6 /

Tapa / Lid / Couvercle / Deckel

18/10



REF	Mod	
P110.000	1/1	1
P230.000	2/3	1
P120.000	1/2	1
P130.000	1/3	1
P140.000	1/4	1
P160.000	1/6	1
P190.000	1/9	1

Tapa plana sin asa / Flat lid without handle / Couvercle plat sans anse / Flacher Deckel ohne Griff



REF	Mod	
P110.005	1/1	1
P120.005	1/2	1

Tapa hermética / Hermetic lid / Couvercle étanche / Hermetischer Deckel

18/10



Detalle silicona
Silicone joint
Joint silicone
Detail Silikon



REF	Mod	
P110.004	1/1	1
P120.004	1/2	1
P130.004	1/3	1
P140.004	1/4	1
P160.004	1/6	1

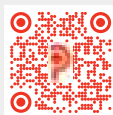

oven



Fija la tapa, el papel de aluminio o el papel film, a la cubeta, para un transporte y almacenamiento seguro. Apta para lavavajillas. Fácil de usar.

Attach the lid, aluminium foil or cling film to the tray for secure transport or storage. Dishwasher safe. Easy to use.

Fixe le couvercle, le papier d'aluminium ou le film alimentaire au bac pour transport et stockage de façon sûre. Va au lave-vaisselle. Facile à utiliser.

Befestigen Sie den Deckel, die Alu- oder Frischhaltefolie am Behälter für einen sicheren Transport und eine sichere Lagerung. Spülmaschinengeeignet. Einfache bedienung

N-0001B Banda selladora silicona GN. Negra / GN Pan Band. Black /
Bande à silicone GN. Noir / GN-Silikon-Band. Schwarz /

PATENTED EXCLUSIVE



oven



+232,2°C



REF	TIPO / TYPE	
N-0001B	1/1	24
N-0002B	1/2	24
N-0003B	1/3	24
N-0006B	1/6	24

P100.004P Presentador cubetas GN / Stand for GN containers /
Support pour bacs GN / Ständer für GN Behälter



Permiten sostener / It can contain /
Il peut contenir / Einsetzmöglichkeiten



6-GN 1/9

En profundidades 65 y 100 mm
65 or 100 mm deep



4-GN 1/6

Profondeurs 65 ou 100 mm
In Tiefen von 65 und 100 mm

REF		
P100.004P	Soporte solo / Only stand / Support seul / Nur Ständer	1

REF	CONJUNTO / SET / LOT / SET	
P100.005P	6 - GN 1/9 65 mm	1
P100.006P	6 - GN 1/9 100 mm	1
P100.008P	4 - GN 1/6 100 mm	1

Adaptable a cubetas GN policarbonato y polipropileno
Adjustable to GN container in polycarbonate and
polypropylene
Adapté à bacs GN en polycarbonate et polypropylène
Passend für GN Behälter aus Polycarbonat und Polypropylen

P100.003P Soporte para tapas GN / Stand for GN lids /
Support pour couvercles GN / Ständer für GN Deckel

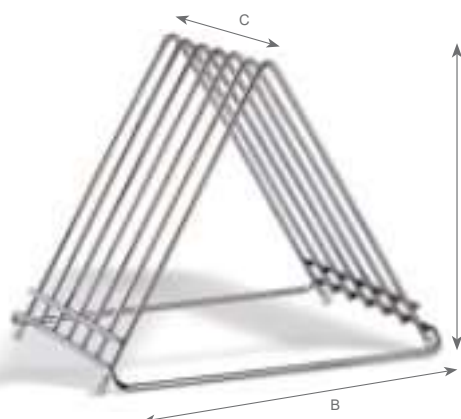

REF	A cm	B cm	C cm	
P100.003P	27	31	27	1

Para 6 tapas
For 6 lids
Pour 6 couvercles
Für 6 Deckel

Distancia entre varillas 2,5 cm
Distance between wires 2,5 cm
Distance entre fils 2,5 cm
Abstand zwischen den Stäben 2,5 cm



IDEA!
Ideal para tablas de corte. Ver página 138-140
Perfect for cutting boards. Refer to page 138-140
Ideal pour planches à découper. Voir page 138-140
Ideal für Schneidbretter. Siehe Seiten 138-140



INDUCTION

PATENTED EXCLUSIVE



Cubetas GN con fondo difusor: únicas, adaptadas a la cocción en placas de inducción mediante fondo sandwich (inox-alu-inox).

BacsGN avecfond thermo-diffuseur apte sur tout type de cuisinières, surtout en induction.

GN containers with sandwich base, suitable for cooking directly on any kind of stoves including induction.

GN Behälter mit Sandwichboden: Einzigartig, Geeignet für das Kochen auf Induktionskochfeldern Mittels Sandwichboden.

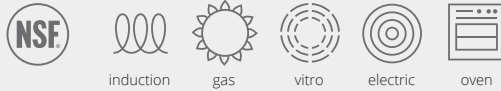
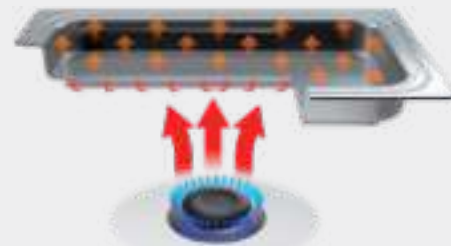

Cubeta GN con fondo difusor / Sandwich bottom GN container /
Bac GN avecfond thermo-diffuseur / GN Behälter mit Sandwichboden



PATENTED EXCLUSIVE

REF	TIPO / TYPE	H mm	Lts	📦
P110.6F1	1/1	65	8,30	1
P111.0F1	1/1	100	14,20	1
P111.5F1	1/1	150	20,20	1
P120.6F1	1/2	65	4,10	1



INOX - ST/STEEL
EDELSTAHL
18/10



Cubeta GN con fondo difusor y asas / Sandwich bottom GN container with handles /
Bac GN avecfond thermo-diffuseur et anses / GN Behälter mit Sandwichboden und Griffen



PATENTED EXCLUSIVE

REF	TIPO / TYPE	H mm	Lts	📦
P111.0F2	1/1	100	14,20	1
P111.5F2	1/1	150	20,20	1



INOX - ST/STEEL
EDELSTAHL
18/10



Ver productos en / See products on / Voir produits en page / Siehe produkte in

P. 397

CUBETA GN ANTIADHERENTE /
NON-STICK GN CONTAINER /
BAC GN ANTI-ADHÉSIVE /
GN BEHÄLTER ANTIHAFT



7.4 CUBETAS GASTRONORM / GASTRONORM CONTAINERS / BACSGASTRONORME/ GASTRONORM BEHÄLTER

GASTRONORM POLICARBONATO / POLYCARBONATE GASTRONORM / GASTRONORME POLYCARBONATE / GASTRONORM POLYCARBONAT



● - 40 °C
● + 130 °C

Utilización: almacenamiento de productos a granel, ingredientes varios en neveras o cámaras frigoríficas. Ideales para presentación en buffets fríos.

Use to store bulk products and ingredients in coolers, freezers or pantry. Highly recommended for transportation and microwaves cooking.

Utilisation : stockage de produits et ingrédients en vrac dans les unités réfrigérées ou placards. Idéal pour le transport et la cuisson en four micro-ondes.

Gebrauch: Lagerung von unverpackten Lebensmittel, Verschiedenen Zutaten in Kühlschränken oder Kühlkammern. Ideal für die Präsentation des Kalten Buffets.

1/1 530 x 325 mm



REF	H mm	Lts	
P110.6C1	65	8,70	12
P111.0C1	100	13,30	12
P111.5C1	150	19,60	12
P112.0C1	200	25,50	6

1/2 325 x 265 mm

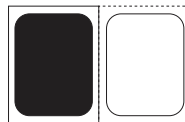

REF	H mm	Lts	
P120.6C1	65	4,00	30
P121.0C1	100	6,00	24
P121.5C1	150	8,70	24
P122.0C1	200	11,20	18

1/3 325 x 175 mm

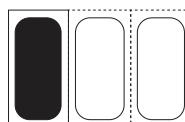

REF	H mm	Lts	
P130.6C1	65	2,35	30
P131.0C1	100	3,50	24
P131.5C1	150	5,00	24
P132.0C1	200	6,35	18

1/4 265 x 162 mm

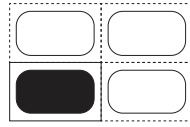

REF	H mm	Lts	
P140.6C1	65	1,65	18
P141.0C1	100	2,46	18
P141.5C1	150	3,47	12

1/6 176 x 162 mm

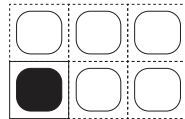

REF	H mm	Lts	
P160.6C1	65	0,95	30
P161.0C1	100	1,40	24
P161.5C1	150	1,95	24

1/9 176 x 108 mm

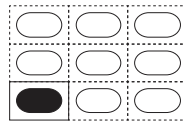

REF	H mm	Lts	
P190.6C1	65	0,54	30
P191.0C1	100	0,77	30

Tapa policarbonato / Polycarbonate lid / Couvercle Polycarbonate / Polycarbonat Deckel



REF	Mod	
P110.0C1	1/1	30
P120.0C1	1/2	60
P130.0C1	1/3	30
P140.0C1	1/4	30
P160.0C1	1/6	60
P190.0C1	1/9	30

Fondo perforado / Perforated bottom / Fond perforé / Gelochter Boden

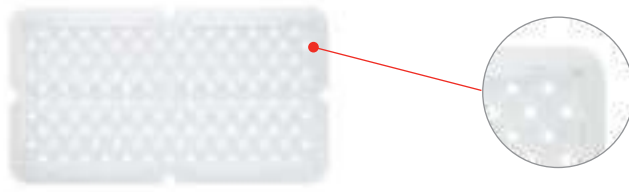

REF	Mod	
P115.0C1	1/1	36
P125.0C1	1/2	24
P135.0C1	1/3	24
P145.0C1	1/4	30

Tapa Polinorm® / Polinorm® Lid / Couvercle Polinorm® / Polinorm® Deckel

PATENTED EXCLUSIVE



REF	Mod	
P110.0 + COLOR	1/1	30
P120.0 + COLOR	1/2	60
P130.0 + COLOR	1/3	30
P140.0 + COLOR	1/4	30
P160.0 + COLOR	1/6	60
P190.0 + COLOR	1/9	30

Ref. color tapa / Ref. colour lid /
Ref. couleur couvercle / Art.Nr. Deckelfarbe



P6 Disponible para 1/1, 1/2, 1/3 y 1/6 /
Available for 1/1, 1/2, 1/3 and 1/6 /
Disponible pour 1/1, 1/2, 1/3 et 1/6 /
Verfügbar für 1/1, 1/2, 1/3 und 1/6 /

Adaptable a / Adjustable to / Adaptable à / Einsetzbar:

Cubetas GN inox, PC, sin Bisfenol-A y PP. No aptas para la gama SP3 /
St/Steel, PC, Bisphenol-A FREE and PP GN containers. Not for SP3 range /
Bacs GN inox, PC, sans Bisphénol-A et PP. Pas pour la gamme SP3 /
Edelstahlbehälter GN, PC, ohne Bisphenol-A und PP. Nicht geeignet für SP3

7.5 CUBETAS GASTRONORM / GASTRONORM CONTAINERS / BACSGASTRONORME/ GASTRONORM BEHÄLTER

CUBETAS GASTRONORM SIN BISFENOL-A / GASTRONORM CONTAINERS, BISPHENOL-A FREE / BACS GASTRONORME SANS BISPHÉNOL-A / GASTRONORM BEHÄLTER OHNE BISFENOL-A



● - 40 °C
● + 90 °C

Cubetas en copoliéster sin Bisfenol-a (100% BPA FREE). Es un material alternativo al policarbonato. Conformes con la norma europea en 631.1 (compatible con los equipos y aparatos gastronorm). Excelente transparencia y resistencia a los impactos. Ideales para almacenar productos en cámaras frigoríficas, de preparación. Cubetas apilables.

Containers made of copolyester without Bisphenol-a (100% BPA FREE). An alternative material to polycarbonate. Complies with european standard en 631.1 (compatible with gastronorm systems and appliances) excellent transparency and impact resistance. Ideal for storing products in cold rooms, for preparation. Stackable containers.

Bacs en copolyester sans Bisphénol-a (100% BPA FREE). Il s'agit d'un matériau alternatif au polycarbonate. Conformes à la norme européenne en 631.1 (compatible avec les machines et appareils gastronorm). Excellente transparence et résistance aux chocs. Idéales pour emmagasiner des produits dans des chambres froides, de préparation. Cuvettes empilables.

Behälter aus COPOLYESTER ohne Bisfenol-a (100% BPA FREE). Es ist ein alternatives Material zu polycarbonat. Entsprechend der europäischen Norm 631.1 (Kompatibel mit allen Systemen und Maschinen Gastronorm). Exzellente Transparenz und resistenz Gegen Stöße. Ideal zum Lagern von produkten in Kühlkammern, Zur Vorbereitung. Behälter stapelbar.

1/1 530 x 325 mm



REF	H mm	Lts	
P110.6BF	65	8,70	12
P111.0BF	100	13,30	12
P111.5BF	150	19,60	12
P112.0BF	200	25,50	6

1/2 325 x 265 mm



REF	H mm	Lts	
P120.6BF	65	4,00	30
P121.0BF	100	6,00	24
P121.5BF	150	8,70	24
P122.0BF	200	11,20	18

1/3 325 x 175 mm



REF	H mm	Lts	
P130.6BF	65	2,35	18
P131.0BF	100	3,50	12
P131.5BF	150	5,00	12

1/4 265 x 162 mm

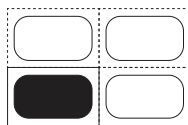

REF	H mm	Lts	
P140.6BF	65	1,65	18
P141.0BF	100	2,46	18
P141.5BF	150	3,47	12

1/6 176 x 162 mm

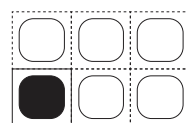

REF	H mm	Lts	
P160.6BF	65	0,95	30
P161.0BF	100	1,40	24
P161.5BF	150	1,95	24

1/9 176 x 108 mm

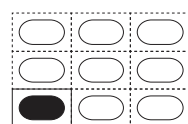

REF	H mm	Lts	
P190.6BF	65	0,54	30
P191.0BF	100	0,77	30

Tapa gastronorm / Gastronorm lid / Couvercle gastronorme / Gastronorm Deckel



REF	Mod	
P110.0BF	1/1	30
P120.0BF	1/2	60
P130.0BF	1/3	30
P140.0BF	1/4	30
P160.0BF	1/6	60
P190.0BF	1/9	30

Fondo perforado / Perforated bottom / Fond perforé / Gelochter Boden

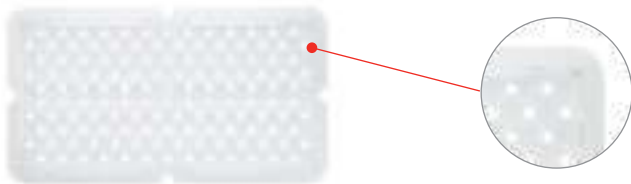

REF	Mod	
P115.0BF	1/1	36
P125.0BF	1/2	24
P135.0BF	1/3	24
P145.0BF	1/4	30
P165.0BF	1/6	30

Tapa Polinorm® / Polinorm® Lid / Couvercle Polinorm® / Polinorm® Deckel

PATENTED EXCLUSIVE



REF	Mod	
P110.0 + COLOR	1/1	30
P120.0 + COLOR	1/2	60
P130.0 + COLOR	1/3	30
P140.0 + COLOR	1/4	30
P160.0 + COLOR	1/6	60
P190.0 + COLOR	1/9	30

Ref. color tapa / Ref. colour lid /
Ref. couleur couvercle / Art.Nr. Deckelfarbe



P6 Disponible para 1/1, 1/2, 1/3 y 1/6 /
Available for 1/1, 1/2, 1/3 and 1/6 /
Disponible pour 1/1, 1/2, 1/3 et 1/6 /
Verfügbar für 1/1, 1/2, 1/3 und 1/6 /

Adaptable a / Adjustable to / Adaptable à / Einsetzbar:

Cubetas GN inox, PC, sin Bisfenol-A y PP. No aptas para la gama SP3 /
St/Steel, PC, Bisphenol-A FREE and PP GN containers. Not for SP3 range /
Bacs GN inox, PC, sans Bisphénol-A et PP. Pas pour la gamme SP3 /
Edelstahlbehälter GN, PC, ohne Bisphenol-A und PP. Nicht geeignet für SP3

7.6 CUBETAS GASTRONORM / GASTRONORM CONTAINERS / BACSGASTRONORME/ GASTRONORM BEHÄLTER



GASTRONORM POLIPROPILENO / POLYPROPYLENE GASTRONORM / GASTRONORME POLYPROPYLENE / POLYPROPYLEN GASTRONORM

PATENTED EXCLUSIVE

● - 40 °C
● + 110 °C



Utilización: almacenamiento de productos a granel, ingredientes varios en neveras o cámaras frigoríficas. Ideal para transporte y cocción en microondas.

Use to store bulk products and ingredients in coolers, freezers or pantry. Highly recommended for transportation and micro-waves cooking.

Utilisation: stockage de produits et ingrédients en vrac dans des unités réfrigérées ou placards. Idéal pour le transport et la cuisson en FOURmicro-ondes.

Gebrauch: Lagerung von unverpackten Lebensmittel, Verschiedenen Zutaten in Kühlschränken oder Kühlkammern. Ideal für den Transport oder zum Kochen in Mikrowellen.

Tapa Polinorm® / Polinorm® Lid / Couvercle Polinorm® / Polinorm® Deckel

PATENTED EXCLUSIVE



Adaptable a / Adjustable to / Adaptable à / Einsetzbar:

Cubetas GN inox, PC, sin Bisfenol-A y PP. No aptas para la gama SP3 / St/Steel, PC, Bisphenol-A FREE and PP GN containers. Not for SP3 range / Bacs GN inox, PC, sans Bisphénol-A et PP. Pas pour la gamme SP3 / Edelstahlbehälter GN, PC, ohne Bisphenol-A und PP. Nicht geeignet für SP3

REF	Mod	
P110.0 + COLOR	1/1	30
P120.0 + COLOR	1/2	60
P130.0 + COLOR	1/3	30
P140.0 + COLOR	1/4	30
P160.0 + COLOR	1/6	60
P190.0 + COLOR	1/9	30

Ref. color tapa / Ref. colour lid / Ref. couleur couvercle / Art.Nr. Deckelfarbe



Disponible para 1/1, 1/2, 1/3 y 1/6 / Available for 1/1, 1/2, 1/3 and 1/6 / Disponible pour 1/1, 1/2, 1/3 et 1/6 / Verfügbar für 1/1, 1/2, 1/3 und 1/6 /



1/1 530 x 325 mm



REF	H mm	Lts	
P110.6P1	65	8,70	12
P111.0P1	100	13,30	12
P111.5P1	150	19,60	12
P112.0P1	200	25,50	6

1/2 325 x 265 mm

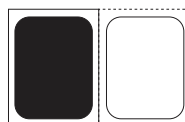

REF	H mm	Lts	
P120.6P1	65	4,00	30
P121.0P1	100	6,00	24
P121.5P1	150	8,70	24
P122.0P1	200	11,20	18

1/3 325 x 175 mm



REF	H mm	Lts	
P130.6P1	65	2,35	18
P131.0P1	100	3,50	12
P131.5P1	150	5,00	12
P132.0P1	200	6,35	6

1/4 265 x 162 mm

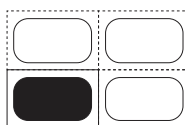

REF	H mm	Lts	
P140.6P1	65	1,65	18
P141.0P1	100	2,46	18
P141.5P1	150	3,47	12

1/6 176 x 162 mm

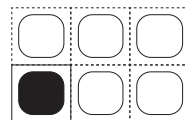

REF	H mm	Lts	
P160.6P1	65	0,95	30
P161.0P1	100	1,40	24
P161.5P1	150	1,95	24

1/9 176 x 108 mm

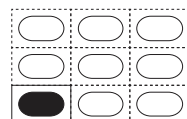

REF	H mm	Lts	
P190.6P1	65	0,54	30
P191.0P1	100	0,77	30

Tapa policarbonato / Polycarbonate lid / Couvercle Polycarbonate / Polycarbonat Deckel



REF	Mod	
P110.0C1	1/1	30
P120.0C1	1/2	60
P130.0C1	1/3	30
P140.0C1	1/4	30
P160.0C1	1/6	60
P190.0C1	1/9	30

**GASTRONORM POLIPROPILENO /
POLYPROPYLENE GASTRONORM /
GASTRONORME POLYPROPYLENE /
POLYPROPYLEN GASTRONORM**



- 40 °C
 + 110 °C

V I O L E T
C O L L E C T I O N

Utilización: almacenamiento de productos a granel, ingredientes varios en neveras o cámaras frigoríficas. Ideal para transporte y cocción en microondas.

Use to store bulk products and ingredients in coolers, freezers or pantry. Highly recommended for transportation and micro-waves cooking.

Utilisation: stockage de produits et ingrédients en vrac dans des unités réfrigérées ou placards. Idéal pour le transport et la cuisson en four micro-ondes.

Gebrauch: Lagerung von unverpackten lebensmittel, verschiedenen zutaten in kühl-schränken oder kühlkammern. Ideal für den transport oder zum kochen in mikrowellen.

**Cubetas Gastronorm / Gastronorm containers /
Bacs Gastronorme / Gastronorm behälter**



REF	TIPO/ TYPE	H mm	Lts	
P111.5P6	1/1	150	19,60	1
P121.5P6	1/2	150	8,70	1
P131.5P6	1/3	150	5,00	1
P161.5P6	1/6	150	1,95	1

**Tapa Polinorm® / Polinorm® Lid /
Couvercle Polinorm® / Polinorm® Deckel**



REF	Mod	
P110.0P6	1/1	30
P120.0P6	1/2	60
P130.0P6	1/3	30
P160.0P6	1/6	60

**Adaptable a / Adjustable to /
Adaptable à / Einsetzbar:**

**Cubetas GN inox, PC, sin Bisfenol-A y
PP. No aptas para la gama SP3 /**

*St/Steel, PC, Bisphenol-A FREE and PP GN
containers. Not for SP3 range /*

*Bacs GN inox, PC, sans Bisphénol-A et
PP. Pas pour la gamme SP3/*

*Edelstahlbehälter GN, PC, ohne Bisphe-
nol-A und PP. Nicht geeignet für SP3*

**Ref. color tapa /
Ref. colour lid /
Ref. couleur couvercle /
Art.Nr. Deckelfarbe**





CUBETAS GN /
GN CONTAINERS /
BACS GN



TRANSPORTE DE ALIMENTOS /
FOOD DELIVERY /
TRANSPORT D'ALIMENTS /
TRANSPORT VON LEBENSMITTELN

8.1 **CAJA PPE / EPP BOX / BOÎTE PPE/ EPP-BOX** **214**

8.2 **INSULATED DELIVERY BAGS** **216**

Bolsas para pizza / Pizza Bags /
Sacs à pizzas / Pizzataschen **216**

Bolsas de catering / Catering Bags /
Sacs de traiteur / Cateringtaschen **218**

Mochila de reparto / Delivery Backpacks /
Sacs à dos de livraison / Lebensmittel-Lieferrucksack **220**

8.3 **BANDEJAS Y RECIPIENTES /**
TRAYS AND CONTAINERS /
PLATEAUX ET PLATS /
TABLETTES UND BEHÄLTER **222**



Ranura interior para fácil inserción de cubetas /
Inner slot for easy insertion of containers /
Rainure intérieure pour une installation facile des cuves /
Innenschlitz zum einfachen Einschub von Behältern

Fabricado en polipropileno expandido (PPE) permite la conservación del frío y el calor durante horas /

Manufactured in expanded polypropylene (EPP) allowing cold and heat to be maintained for hours /

Fabriqué en polypropylène expansé (PPE) qui permet la conservation du froid et de la chaleur pendant plusieurs heures /

Hergestellt aus expandiertem Polypropylen (PSA), zum stundenlangen Warmhalten oder Kühlen von Speisen

Carga superior, 1/1 GN /
Superior load, GN 1/1 /
Charge supérieure, 1/1 GN /
Höhere Tragkraft, GN 1/1

Asas encastradas en los laterales /
Inset handles on the sides /
Anses encastrées sur les latéraux /
Vertiefte Griffe an den Seiten

100% reciclable /
100% recyclable /
100 % recyclable /
100 % recycelbar

Plegable para facilitar el almacenaje y el transporte /
Foldable to make storage and transport easier /
Pliable pour faciliter le stockage et le transport /
Klappbar für platzsparende Lagerung und leichten Transport

TRANSPORTE ALIMENTOS /
FOOD DELIVERY /
TRANSPORT ALIMENTS

P99001 Caja plegable PPE/ Foldable EPP crate / Boîte pliable EPP/ Faltbare EPP-box



REF	cm	Dim int / Inner sizes / Dim. int. / Innenmasse cm	Lt	GN	
P99.001	60 x 40 x 25	53,8 x 33,8 x 20	38	1/1	1

Asas reforzadas para fácil transporte /
Reinforced handles for ease of transport /
Anses renforcées pour un transport facile /
Verstärkte Griffe für einen leichten Transport

Bolsillo transparente /
Transparent pocket /
Poche transparente /
Durchsichtige Tasche

Aislamiento térmico para conservar la temperatura /
Thermal insulation to maintain the temperature /
Isolation thermique pour conserver la température /
Wärmeisolierung zur Erhaltung der Temperatur

Cinta para poder colgar la bolsa /
Band to be able hang the bag /
Bande pour pouvoir accrocher le sac /
Band zum Aufhängen der Tasche



Material grueso y resistente fácil de limpiar /
Thick, sturdy and easy to clean material /
Matériau épais et résistant, facile à nettoyer /
Dickes, strapazierfähiges und leicht zu reinigendes Material

P9902 Bolsas para pizza / Pizza Bags / Sacs à pizzas / Pizzataschen

REF	cm	
P99.020	45 x 45 x 16	1
P99.021	49,5 x 49,5 x 26	1

NEW!



P99.021



P99.020



Asas reforzadas para fácil transporte /
Reinforced handles for ease of transport /
Ansesrenforcées pour un transport facile /
Verstärkte Griffe für einen leichten Transport

Bolsillo transparente con cremallera /
Transparent pocket with zipper /
Poche transparente avec fermeture Éclair /
Durchsichtige Tasche mit Reißverschluss

Aislamiento térmico para conservar la temperatura /
Thermal insulation to maintain the temperature /
Isolation thermique pour conserver la température /
Wärmeisolierung zur Erhaltung der Temperatur

Cinta para poder colgar la bolsa /
Band to be able hang the bag /
Bande pour pouvoir accrocher le sac /
Band zum Aufhängen der Tasche

Ribetes reflectantes para un reparto nocturno más seguro /
Reflective piping for safer night time delivery /
Passepoil réfléchissant pour des livraisons plus sûres la nuit /
Reflektorstreifen für sichere Lieferung im dunkeln

Carcasa exterior resistente a la humedad /
Moisture-resistant outer shell /
Enveloppe extérieure résistant à l'humidité /
Aussengehäuse resistent gegen feuchtigkeit



VPB Bolsas para pizza / Pizza Bags / Sacs à pizzas / Pizzataschen



REF	SERIE	cm	
VPB116	SERIE 1	44,5 x 44,5 x 22,9	1
VPB118	SERIE 1	48,3 x 48,3 x 22,9	1



VPB118
Bolsa para pizza, 18" / 18" Pizza bag /
Sacà pizzas, 18" / Pizzataschen 18"



VPB116
Bolsa para pizza, 16" / 16" Pizza bag /
Sacà pizzas, 16" / Pizzataschen 16"





P9903 Bolsas de catering / Catering bags / Sacs de traiteur / Cateringtaschen



REF	cm	GN	
P99.030	38 x 30,5 x 38	1/2	1
P99.031	56 x 36 x 36	1/1	1



VCB Bolsas de catering / Catering bags / Sacs de traiteur / Cateringtaschen

REF	SERIE	cm	
VCBM100	SERIE 1	43,2 x 33 x 33	1
VCBL100	SERIE 1	58,4 x 38,1 x 35,6	1



VCBL100



VCBM100



Serie 3

La pauta de referencia del ingenio térmico.
La comida caliente genera calor en la bolsa mientras que el aislamiento de alto rendimiento ayuda a retenerlo, manteniendo la comida caliente y deliciosa.
INCLUDES: Bolsa

The baseline of warmth ingenuity. The hot food generates heat in the bag while the high performance insulation helps retain the heat, keeping food as warm as it is delicious.
INCLUDES: Bag

La référence en matière d'inventivité. Les aliments chauds dégagent de la chaleur dans le sac tandis que l'isolant ultra-performant piège la chaleur, gardant les aliments aussi chauds que délicieux.
INCLUDES:Housse de transport

Das Paradebeispiel der Wärmetechnik. Das heiße Essen erwärmt die Tasche, während die stark isolierende Eigenschaft dazu beiträgt, die Wärme zu erhalten, damit das Essen warm und lecker bleibt.
ENTHÄLT: Tasche

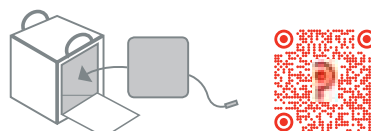

Serie 5

El siguiente nivel en nuestra línea de bolsas de reparto incluye una almohadilla térmica que precalienta la bolsa. Coloque la comida caliente en la bolsa precalentada, desconecte la almohadilla térmica y listo. O use el cable de alimentación opcional de 12 V en el automóvil para calentar continuamente la bolsa durante el transporte.
INCLUDES: Bolsa / Heat pad / Adaptador heat pad con enchufe
OPCIONAL: Cable conector coche 12V

The next step in our heating bag line features a heat pad that pre-heats the bag. Place your hot food into the pre-heated bag, unplug the heat pad and go. Or use the optional 12V in-car power cord to continually heat the bag during transport.
INCLUDES: Bag / Heat Pad / adaptor heat pad with plug
OPTIONAL: 12 V In-car power cord

Le niveau supérieur dans notre ligne de sacs de livraison a un coussin chauffant qui préchauffe le sac. Placez vos aliments chauds dans le sac préchauffé, débranchez le coussin chauffant et partez faire votre livraison. Ou utilisez le câble d'alimentation 12 V sur allume-cigares en option pour continuer à chauffer le sac en cours de transport.
INCLUDES:Housse de transport / Corps de chauffe / Adaptateur prise corps de chauffe.
OPTIONAL:Cordon d'alimentation 12V de voiture

ENTHÄLT: Tasche / Wärmekissen / adapter wärmekissen mit stecker
OPTIONAL: 12 V auto stromkabel

VTB Bolsas torre / Tower bags / Sacs-Tours / Hohe Taschen

Bolsa tipo torre con asas de mochila y correa de reposacabezas /
Tower bag with backpack straps and headrest strap /
Sac-tour avec bretelles de sac à dos et sangle d'appui-tête /
Hohe Tasche mit Rucksackgurten und Kopfstützgurt

REF	SERIE	cm	
VTB300	SERIE 3	45,7 x 55,9 x 43,2	1
VTB50002	SERIE 5	45,7 x 55,9 x 43,2	1



ACCESORIOS / ACCESSORIES / ACCESSOIRES/ZUBEHÖR

VTBWR-1

Estructura metálica / Wire insert /
Structure métallique / Metallstruktur



REF	
VTBWR-1	1

Accesorio no incluido/
Accessory not included /
Accessoire non inclus /
Zubehör nicht im
Lieferumfang enthalten.

VDBBM Mochila reparto de alimentos / Food delivery backpack bags /
Sacs à dos de livraison d'aliments / Lebensmittel-Lieferrucksack

Bolsa mochila con bastidor integrado para reparto de alimentos /
Food delivery backpack bag with integrated frame /
Sac à dos de livraison d'aliments à armature intégrée /
Rucksack mit integriertem Gestell für Lebensmittel-Auslieferung

REF	SERIE	cm	
VDBBM300	SERIE 3	40,6 x 40,6 x 33	1
VDBBM50002	SERIE 5	40,6 x 40,6 x 33	1



Las bolsas y los insertos de alambre se pliegan fácilmente para un almacenamiento compacto /

Bags & wire inserts fold easily for compact storage /

Lessacset les inserts métalliques se plient facilement pour un rangement compact /

Die taschen und drahteinsätze lassen sich für eine kompakte aufbewahrung leicht zusammenfallen /

P919001

Bandeja policarbonato de 5 compartimentos /
Polycarbonate tray with 5 compartments /
Plateau polycarbonate avec 5 compartiments /
Polycarbonatschale mit 5 Unterteilungen



Apilable /
Stackable /
Empilable /
Stapel

***Sólo usar con bandeja de Policarbonato /**
For use with Polycarbonate tray only /
Utiliser uniquement bac en Polycarbonate /
Nur mit Polycarbonatschale verwenden

Apto para lavavajillas / Dishwasher safe /
Utilisable au lave-vaisselle / Geeignet für Spülmaschinen

REF	mm	
P919.001	330 x 330 x 35	1
P919.002*	tapa / cover / couvercle / Deckel	1

P919003

Bandeja polipropileno de 5 compartimentos /
Polypropylene tray with 5 compartments /
Plateau polypropylène avec 5 compartiments /
Früstück polypropylen deckel 5 fächer



Apilable /
Stackable /
Empilable /
Stapel

Apto para lavavajillas / Dishwasher safe /
Utilisable au lave-vaisselle / Geeignet für Spülmaschinen

REF	mm	
P919.003	330 x 330 x 35	1

P919 **Bandeja isotérmica / Isothermal tray /** **Plateau Isotherme / Isothermisches Tablett**



REF	mm	
P919.000	530 x 370 x 110	1

Fabricada en polipropileno con interior aislante de poliuretano. Sin CFC.
Made of polypropylene with insulating polyurethane without CFC interior.
Fabriqué en polypropylène avec intérieur de polyuréthane sans CFC.
Hergestellt aus Polypropylen mit Innenisolierung aus Polyurethan. Ohne CFC.

Adaptado para plato llano, hondo, bol, fuente rectangular en policarbonato, porcelana o melamina.
Suitable for flat plate, soup plate, bowl, salad bowl on polycarbonate, chinaware or melamine.
Apte pour assiettes plates, à soupe, bols, ravers, soit en polycarbonate, porcelaine ou melamine.
Geeignet für flache und tiefe Teller, Schüssel, rechteckige Schale aus Polycarbonat, Porzellan oder Melamin.

Complementos no incluidos / Complements not included /
Compléments non-inclus / Zubehör nicht inklusive

Ver productos en / See products on / Voir produits en page / Siehe produkte in

P. 256

CARRO TRANSPORTE BANDEJAS /
TRAY TRANSPORT TROLLEY /
CHARIOT TRANSPORT PLATEAUX /
TRANSPORTWAGEN



P920

Platos policarbonato /
Polycarbonate plates /
Assiettes en polycarbonate /
Polycarbonat Teller



Ref. P920.001

Apto para lavavajillas y microondas /
Dishwasher and microwave safe /
Utilisable au lave-vaisselle et micro-ondes /
Geeignet für Spülmaschinen und Mikrowellen

REF	Tipo / Type	Ø mm	H mm	
P920.001	Llano / Flat / Plat / Flach	206	29	1
P920.002	Hondo / Soup / À soupe / Tief	185	45	1
P920.003	Desayuno / Breakfast / Petit déjeuner / Frühstück	175	25	1

P921

Bol doble pared policarbonato con tapa /
Double wall polycarbonate bowl with lid /
Bol polycarbonate double paroi avec couvercle /
Doppelwändige Schüssel aus Polycarbonat mit Deckel



Apto para lavavajillas /
Dishwasher safe /
Utilisable au lave-vaisselle /
Geeignet für Spülmaschinen

REF	Ø mm	H mm	Lts	
P921.001	125	68	0,45	1

Fuente rectangular policarbonato /
Polycarbonate rectangular bowl /
Ravier rectangulaire en polycarbonate /
Rechteckige Schale aus Polycarbonat

P922



Apto para lavavajillas y microondas /
Dishwasher and microwave safe /
Utilisable au lave-vaisselle et micro-ondes /
Geeignet für Spülmaschinen und Mikrowellen

***Tapa rígida /**
**Rigid lid /*
*Couvercle rigide /
**Harter Deckel*

REF	mm	H mm	Lts	
P922.000	95 x 138	45	0,25	1
P922.100*	96 x 139	24	-	1

Taza desayuno policarbonato /
Polycarbonate breakfast cup /
Tasse dessert polycarbonate /
Frühstückstasse aus Polycarbonat

P923



Apto para lavavajillas y microondas /
Dishwasher and microwave safe /
Utilisable au lave-vaisselle et micro-ondes /
Geeignet für Spülmaschinen und Mikrowellen

***Tapa /**
**Lid /*
*Couvercle /
**Deckel*

REF	mm	H mm	Lts	
P923.000	94	68	0,325	1
P923.001*	100	-	-	1

P924 Vaso policarbonato / Polycarbonate glass / Verre en polycarbonate / Polycarbonat Becher



REF	Color / Couleur	Ø mm	H mm	Lts	
P924.001	White	70	102	0,25	1
P924.002	White	70	70	0,17	1
P924.002A	Blue	70	70	0,17	1
P924.002R	Red	70	70	0,17	1
P924.002V	Green	70	70	0,17	1



Apto para lavavajillas / Dishwasher safe
Utilisable au lave-vaisselle / Spülmaschinen geeignet

P8610 **Bandeja fast - food fibra de vidrio / Fiberglass fast - food tray /**
Plateau fast food fibre de verre / Fiberglasfast - food Tablett



REF	mm	
P861.045	455 x 355	12
P861.053	530 x 325	12

Color gris / Grey color / Couleur gris / Farbe grau.





























86100 **Bandejas de polipropileno para comida rápida / Polypropylene Fast Food Trays /**
Plateaux de restauration rapide en polypropylene / Polypropylen- Imbisstabletts



 + 86°C

Recyclable/
 Recyclable/
 Recyclable/
 Recyclingfähig



REF		cm	
86100		25,4 x 35,6	24
86101		25,4 x 35,6	24
86103		25,4 x 35,6	24
86104		25,4 x 35,6	24
86105		25,4 x 35,6	24
86106		25,4 x 35,6	24
86107		25,4 x 35,6	24
86108		25,4 x 35,6	24
86109		25,4 x 35,6	24
86110		30,5 x 40,6	24
86111		30,5 x 40,6	24
86113		30,5 x 40,6	24
86114		30,5 x 40,6	24
86115		30,5 x 40,6	24
86116		30,5 x 40,6	24
86117		30,5 x 40,6	24
86118		30,5 x 40,6	24
86119		30,5 x 40,6	24
86120		35,6 x 45,7	12
86121		35,6 x 45,7	12
86123		35,6 x 45,7	12
86124		35,6 x 45,7	12
86125		35,6 x 45,7	12
86126		35,6 x 45,7	12
86127		35,6 x 45,7	12
86128		35,6 x 45,7	12
86129		35,6 x 45,7	12

El borde grueso reforzado con acanalados en las esquinas añade resistencia a los impactos. Cuatro cuñas de apilado para secar rápidamente y evitar que se peguen entre sí. Acabado texturizado entretrejado semi-brillante que aporta una superficie menos resbaladiza.

Thick reinforced rim with corner ribs add impact strength. Four stacking lugs speed drying and prevent sticking. Semi-gloss, weave-grain textured finish provides a reduced-slip surface.

Rebord reforcé épais avec nervures aux angles pour accroître la résistance aux chocs. Les quatre cales d'empilage accélèrent le séchage et empêchent les plateaux de coller entre eux. La texture tissée semi-brillante donne une surface moins glissante.

Dicker, verstärkter Rand mit Eckenrippen verbessert die Schlagfestigkeit. Vier Stapelnasen beschleunigen das Trocknen und verhindern ein Aneinanderhaften der Tablett. Texturierte Maserung erzeugt eine rutschbeständige Oberfläche.

P340 **Bandeja auto - servicio acero inox / St/steel self - service tray /**
Plateau self - service acier inox / Selbstbedienungstablettrostfreier Stahl



REF	mm	H mm	
P340.000	460 x 285	20	1

6 Compartimentos / 6 Compartments /
 6 Compartiments / 6 Unterteilungen

P8070

Soporte para bandejas porta - cubiertos /
Counter - top cutlery dispenser /
Support porte - couverts /
Ständer für Besteckkasten



Compatible: REF.P900.000

No incluye bandeja portacubiertos / Cutterly bin not included /
Bac ramasse - couverts non inclus / Besteckkasten nicht inklusive

REF	mm	
P80.700	526 x 510 x 328	1

P8071

Soporte doble para bandejas porta - cubiertos /
Double counter - top cutlery dispenser /
Support double porte - couverts /
Doppelständer für Besteckkasten



Compatible: REF.P900.000

No incluye bandeja portacubiertos / Cutterly bin not included /
Bac ramasse - couverts non inclus / Besteckkasten nicht inklusive

REF	mm	
P80.710	526 x 510 x 580	1

P8072

Soporte para 4 cubetas GN 1/3 /
Counter - top dispenser for 4 GN containers 1/3 /
Support pour 4 bacs GN 1/3 /
Ständer für 4 Behälter GN 1/3



No incluyen cubetas GN / GN containers not included /
Bacs GN non inclus / GN Behälter nicht inklusive

REF	mm	
P80.720	738 x 310 x 430	1

P8073

Soporte para 8 cubetas GN 1/3 /
Counter - top dispenser for 8 GN containers 1/3 /
Support pour 8 bacs GN 1/3 /
Ständer für 8 Behälter GN 1/3



No incluyen cubetas GN / GN containers not included /
Bacs GN non inclus / GN Behälter nicht inklusive

REF	mm	
P80.730	738 x 465 x 600	1

P900 Bandeja porta - cubiertos gastronorm 1/1 / 1/1 gastronorm cutlery bin /

Bac ramasse - couverts gastronorme 1/1 / Besteckkasten GN 1/1



REF	mm	
P900.000	530 x 325 x 100	1

Polipropileno alimentario / Food contact polypropylene /
Polypropylène alimentaire / Polypropylen geeignet für den Lebensmittelkontakt



**CESTAS PARA VAJILLA /
DISHWASHER RACKS /
CASIERS À VAISSELLE /
SPÜLMASCHINENKÖRBE**

9.1	CESTAS BASE Y SUPLEMENTOS / RACKS AND EXTENDERS / PANIERS BASE ET RÉHAUSSE / BASISKÖRBE UND ERWEITERUNGEN	232
9.2	COMPLEMENTOS / COMPLEMENTS / COMPLÉMENTS/ ZUBEHÖR	238
9.3	CESTAS PARA PLATOS / PLATE RACKS / CASIERSASSIETTES/ TELLERSPÜLKÖRBE	240

FLAP RACK® by pujadas®

A VOLLRATH® COMPANY

Sistema de montaje y desmontaje fácil, seguro y sencilla personalización /
Easy assembly and disassembly system, safe and simple customization /
 Système de montage et démontage facile, sûr et de simple personnalisation /
Einfaches montage- und demontagesystem, sichere und einfache personalisierung

Apilables con otras cestas del mercado, refuerzo de doble pared (anti-golpes) /
Stackable with other market racks reinforced double-wall (anti-shock) /
 Empilable avec d'autres paniers du marché, renforcé avec double paroi (anti-choc) /
Stapelbar mit anderen Körben auf dem Markt, verstärkt mit Doppelwand (anti-stoss)

ABIERTA / OPENED / OUVERT / OFFEN

Aperturas para máxima limpieza
Openings for maximum cleaning
 Ouvertures pour un nettoyage performant
Öffnungen für maximale Reinigung

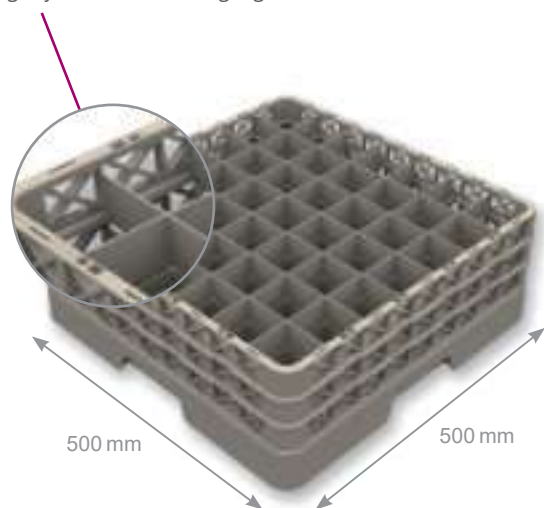

CERRADA / CLOSED / FERMÉ / GESCHLOSSEN

Ideales para el transporte y el almacenamiento
Ideal for transporting and storing
 Idéal pour le transport et le stockage
Ideal für den transport und lagerung

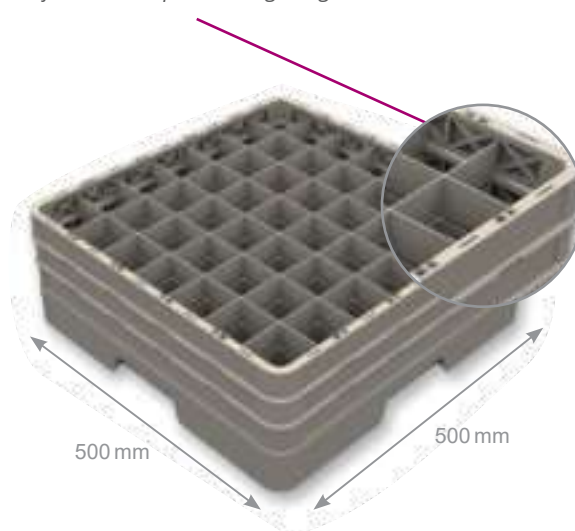

ESCOGER LO BUENO Y LO MEJOR A LA VEZ* /
GET THE BEST OF BOTH WORLDS /*
 LE BON ET LE MEILLEUR À LA FOIS* /
*NEHMEN SIE DAS GUTE UND DAS BESTE AUF EINMAL**

FLAP-RACK®: fácil montaje / desmontaje
FLAP-RACK®: easy to assembly / disassembly
 FLAP-RACK®: facile à monter / démonter
FLAP-RACK®: Einfache Montage / Demontage

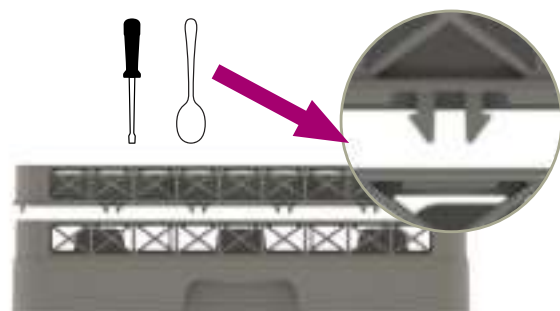

LAVADO: Mayor limpieza
WASHING: Higher cleaning
 LAVAGE: Meilleur nettoyage
REINIGUNG: Bessere Reinigung



TRANSPORTE: Mayor seguridad
TRANSPORT: Higher security
 TRANSPORT: Plus de sécurité
TRANSPORT: Höhere Sicherheit



ALMACENAMIENTO: Mayor Higiene
STORING: Higher hygiene
 STOCKAGE: Plus hygiénique
LAGERUNG: Höhere Hygiene

* Copolímero altamente resistente a sustancias químicas y temperaturas de hasta 95 °C.
 * Copolymer highly resistant to chemical products and temperatures up to 95 °C.
 * Copolymère très résistant aux produits chimiques et à températures jusqu'à 95 °C.
 * Copolymer höchster Widerstand gegen chemische Substanzen und Temperaturen bis zu 95 °C.

FLAP RACK® by pujadas®

A VOLLRATH® COMPANY



Sistema patentado que permite cerrar y abrir las paredes de las cestas y extensiones fácilmente

System patented allows the walls on both bases and extenders to be closed or open easily

Système breveté qui permet d'ouvrir ou de fermer facilement les parois des CASIERS et des RÉHAUSSES

Patentiertes System, welches das einfache öffnen und Schliessen der Spülkorbwände und die Vergrößerung erlaubt

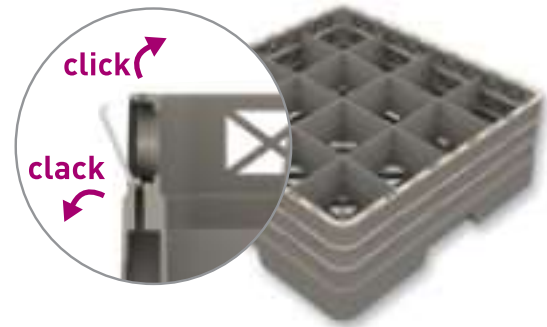

FLAP IDENTIFICADOR

Identificador de colores para cestas y extensiones completamente cerradas. Disponible en 6 colores. Posibilidad de marcar logo cliente.
Colour identification for completely closed racks and extensions. Available in 6 colours. Possible personalisation.
Identificateur en couleurs pour casiers et réhaussements complètement fermés. Disponible en 6 couleurs. Personnalisation possible.
Farbidentifikation für Spülkörbe und Vergrößerungen komplett geschlossen. Erhältlich in 6 Farben. Möglichkeit der Markierung mit dem Firmenlogo.



F1 Marrón
Brown
Marron
Braun



F4 Amarillo
Yellow
Jaune
Gelb



F2 Burdeos
Burgundy
Bordeaux
Bordeauxrot



F5 Verde
Green
Vert
Grün



F3 Azul
Blue
Bleu
Blau



F6 Marrón oscuro
Dark brown
Marrón foncé
Dunkelbraun



Logo o texto impreso / Printed logo or text /
Logo ou texte imprimé / Logo oder Text gedruckt



Logo o texto estampado / Hot stamped logo or text /
Logo ou texte gravé / Logo oder Text gestempelt



501F Flap

FLAP RACK®



REF	COLOR / COLOUR / COULEUR / FARBE	
P501 F1	Marrón / Brown / Marrón / Braun	24
P501 F2	Burdeos / Burgundy / Bordeaux / Bordeauxrot	24
P501 F3	Azul / Blue / Bleu / Blau	24
P501 F4	Amarillo / Yellow / Jaune / Gelb	24
P501 F5	Verde / Green / Vert / Grün	24
P501 F6	Marrón oscuro / Dark brown / Marrón foncé / Dunkelbraun	24

9.1 CESTAS PARA VAJILLA / DISHWASHER RACKS / CASIERS À VAISSELLE / SPÜLMASCHINENKÖRBE

T-VERSION

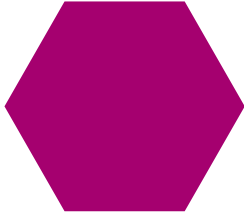

DISEÑADAS CON UN 17-30% MÁS DE CAPACIDAD PARA VASOS Y COPAS QUE LAS CESTAS TRADICIONALES

DESIGNED TO HOLD 17-30% MORE GLASSWARE THAN A TRADITIONAL RACK

CONÇUS POUR CONTENIR DE 17 À 30 % DE VERRES EN PLUS QU'UN CASIER TRADITIONNEL

NIMMT 17-30 % MEHR GLASER AUF ALS KONVENTIONELLE SPÜLKORBE

EXTENSORES A PRESIÓN

No se sueltan con el tiempo

No se aceptan devoluciones de cestas montadas

SNAP-FIT EXTENDERS

Will not loosen or come apart over time

Assembled racks can not be refunded

LE EXTENSIONS À ENCLÈCHEMENT

No se delojaron pas au fil des ans

Tout retour de casiers assemblés n'est pas accepté

AUFSCHNAPPVERLÄNGERUNGEN

Lösen sich im Laufe der Zeit nicht voneinander ab

Montierte Körbe können nicht zurückgegeben werden

DISEÑO DE PERFIL ABIERTO

Permite un lavado y secado de arriba a abajo y de lado a lado

OPEN PROFILE DESIGN

Allows top-to-bottom and side-to-side washing and drying

LE CONCEPT À PROFIL OUVERT

Permet un lavage et un séchage de haut en bas et d'un côté à l'autre

OFFENES DESIGN

Ermöglicht Waschen und Trocknen von oben nach unten und von einer Seite zur anderen

MANEJO CÓMODO

Con asas en los cuatro lados

CONVENIENT HANDLING

With handles on all four sides

MANIPULATION PRATIQUE

râce aux poignées des quatre côtés

PRAKTISCHE TRAGEVORRICHTUNG

Mit Griffen an allen vier Seiten

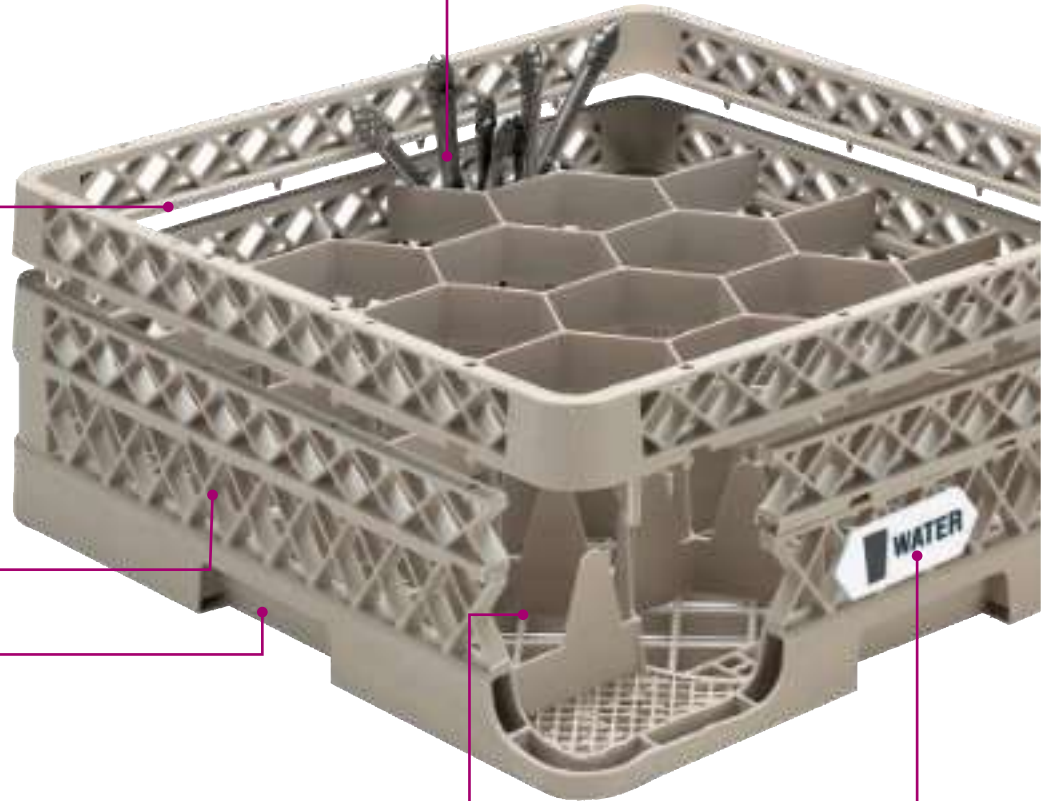

LOS DIVISORES INCORPORADOS brindan una protección 100% vertical de los vasos y las copas

BUILT-IN BASE RACK DIVIDERS provide 100% vertical glassware protection

LES PARTITIONS DE CASIER DE BASE INTÉGRÉES offrent une protection des verres 100% verticale

INTEGRIERTE KORBBODEN-TRENNEINSÄTZE bieten 100-prozentigen vertikalen Schutz vor Glasbruch

CLIPS DE IDENTIFICACIÓN DE COLORES para facilitar la identificación

COLOUR IDENTIFICATION CLIP for easy identification

CLIPS IDENTIFICATEUR EN COULEURS pour une identification plus facile

FARBIDENTIFIKATION zur einfachen Kennzeichnung

CLIP Clip identificación / Clip tags / Clip d'identification / Klippidentifizierung

T-VERSION

C1/01

Marrón / Brown / Marron / Braun

C2/02

Rojo / Red / Rouge / Rot

C6/03

Naranja / Orange / Orange / Orange

C3/04

Azul / Blue / Bleu / Blau

C7/05

Blanco / White / Blanc / Weiss

C8/06

Negro / Black / Noir / Schwarz

C4/08

Amarillo / Yellow / Jaune / Gelb

C5/19

Verde / Green / Vert / Grün

C9/32

Beige / Beige / Beige / Beige



REF	Color / Colour	
1009-01		1
1009-02		1
1009-03		1
1009-04		1
1009-05		1
1009-06		1
1009-08		1
1009-19		1
1009-32		1

FLAP RACK®

T-VERSION

FLAPS	✓	
CLIP IDENTIFICACIÓN / CLIP TAGS / CLIP D'IDENTIFICATION / KLIPPIDENTIFIZIERUNG		✓
CESTAS ABIERTAS / OPENED RACKS / PANIER OUVERTS / SPÜLKORB OFFENES	✓	✓
CESTAS CERRADAS / CLOSED RACKS / PANIER FERMÉES / SPÜLKORB GESCHLOSSENES	✓	
CESTAS MEDIO TAMAÑO / HALF-SIZE RACKS / CASIERSDEMI-TAILLE / SPÜLKÖRBE IN HALBGRÖßE		✓
DESMONTABLE / DISASSEMBLY / DÉMONTER / DEMONTAGE	✓	
COMPARTIMENTOS / COMPARTMENTS / COMPARTIMENTS / FÄCHER 	✓	✓
COMPARTIMENTOS / COMPARTMENTS / COMPARTIMENTS / FÄCHER 		✓
	✓	✓



9.1 CESTAS PARA VAJILLA / DISHWASHER RACKS / CASIERSÀ VAISSELLE/ SPÜLMASCHINENKÖRBE

ABIERTAS / OPENED / OUVERTS/ OPEN

∅ max. 151 mm

FLAP RACK



P5090
BASE9 COMPART.



P5091
EXT. 9 COMPART.

REF	
P5090	6
P5091	12

∅ max. 122 mm

T-VERSION



TR18
BASE12 COMPART.



TRJ
EXT. 12 COMPART.

REF	
TR18	6
TRJ	12

∅ max. 113 mm

FLAP RACK



P5160
BASE16 COMPART.



P5161
EXT. 16 COMPART.

REF	
P5160	6
P5161	12

∅ max. 100 mm

T-VERSION



TR11
BASE20 COMPART.



TRG
EXT. 20 COMPART.

REF	
TR11	6
TRG	12

∅ max. 89 mm

FLAP RACK



P5250
BASE25 COMPART.



P5251
EXT. 25 COMPART.

REF	
P5250	6
P5251	12

 Ø max. 81 mm

T-VERSION



TR12
BASE30 COMPART.



TRH
EXT. 30 COMPART.

REF	
TR12	6
TRH	12

 Ø max. 73 mm

FLAP RACK®



P5360
BASE36 COMPART.

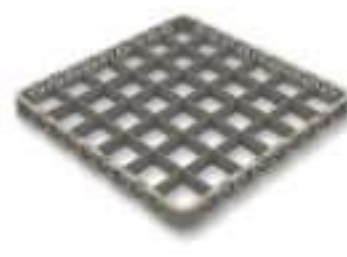

P5361
EXT. 36 COMPART.

REF	
P5360	6
P5361	12

 Ø max. 70 mm

T-VERSION



TR13
BASE42 COMPART.



TRM
EXT. 42 COMPART.

REF	
TR13	6
TRM	12

 Ø max. 63 mm

FLAP RACK®



P5490
BASE49 COMPART.

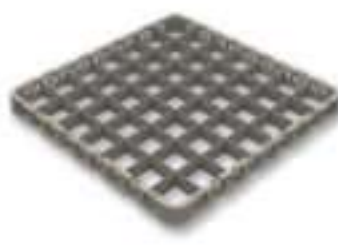

P5491
EXT. 49 COMPART.

REF	
P5490	6
P5491	12

 Ø max. 151 mm

9 COMPART.

FLAP RACK®



REF	△ lmax. (mm)	H (mm)*
P5090 E1	120	140
P5090 E2	160	180
P5090 E3	200	220
P5090 E4	240	260
P5090 E5	280	300

 Ø max. 122 mm

12 COMPART.

T-VERSION



REF	△ lmax. (mm)	H (mm)*
TR18 J	122	140
TR18 JJ	162	181
TR18 JJJ	200	222
TR18 JJJJ	240	262
TR18 JJJJ	279	302

 Ø max. 113 mm

16 COMPART.

FLAP RACK®



REF	△ lmax. (mm)	H (mm)*
P5160 E1	120	140
P5160 E2	160	180
P5160 E3	200	220
P5160 E4	240	260
P5160 E5	280	300

 Ø max. 100 mm

20 COMPART.

T-VERSION



REF	△ lmax. (mm)	H (mm)*
TR11 G	122	140
TR11 GG	162	181
TR11 GGG	200	222
TR11 GGGG	240	262
TR11 GGGGG	279	302

 Ø max. 89 mm

25 COMPART.

FLAP RACK®



REF	△ lmax. (mm)	H (mm)*
P5250 E1	120	140
P5250 E2	160	180
P5250 E3	200	220
P5250 E4	240	260
P5250 E5	280	300

 Ø max. 81 mm
30 COMPART.

T-VERSION



REF	△ max. (mm)	H (mm)*
TR12 H	122	140
TR12 HH	162	181
TR12 HHH	200	222
TR12 HHHH	240	262
TR12 HHHHH	279	302

 Ø max. 73 mm
36 COMPART.

FLAP RACK®



REF	△ max. (mm)	H (mm)*
P5360 E1	120	140
P5360 E2	160	180
P5360 E3	200	220
P5360 E4	240	260
P5360 E5	280	300

 Ø max. 70 mm
42 COMPART.

T-VERSION



REF	△ max. (mm)	H (mm)*
TR13 M	52	73
TR13 MM	91	114
TR13 MMM	130	156
TR13 MMMM	172	194

 Ø max. 63 mm
49 COMPART.

FLAP RACK®



REF	△ max. (mm)	H (mm)*
P5490 E1	120	140
P5490 E2	160	180
P5490 E3	200	220
P5490 E4	240	260
P5490 E5	280	300

* Altura total del conjunto
* Total set height
* Hauteur totale lot
* Gesamthöhe des Sets

Ver productos en / See products on / Voir produits en page / Siehe produkte in

P.
259

**CARRO PARA CESTAS /
TROLLEY FOR DISHWASHER RACKS /
CHARIOT POUR CASIERSÀ VAISSELLE /
WAGEN FÜR SPÜLKÖRBE**



9.1 CESTAS PARA VAJILLA / DISHWASHER RACKS / CASIERSÀ VAISSELLE/ SPÜLMASCHINENKÖRBE

CERRADAS / CLOSED / FERMÉS/ GESCHLOSSEN

Ø max. 151 mm

FLAP RACK®



P5090 F1
BASE9 COMPART.



P5091 F1
EXT. 9 COMPART.

REF	
P5090 F1	6
P5091 F1	12

Ø max. 113 mm

FLAP RACK®



P5160 F1
BASE16 COMPART.



P5161 F1
EXT. 16 COMPART.

REF	
P5160 F1	6
P5161 F1	12

Ø max. 89 mm

FLAP RACK®



P5250 F1
BASE25 COMPART.



P5251 F1
EXT. 25 COMPART.

REF	
P5250 F1	6
P5251 F1	12

Ø max. 73 mm

FLAP RACK®



P5360 F1
BASE36 COMPART.

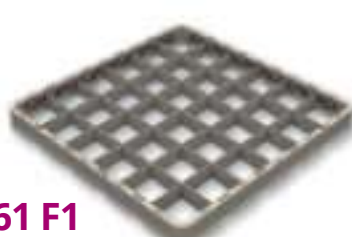

P5361 F1
EXT. 36 COMPART.

REF	
P5360 F1	6
P5361 F1	12

Ø max. 63 mm

FLAP RACK®



P5490 F1
BASE49 COMPART.

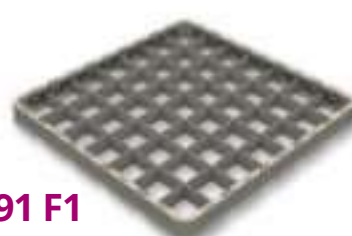

P5491 F1
EXT. 49 COMPART.

REF	
P5490 F1	6
P5491 F1	12

Indicar el código de color al final de la referencia.
Indicate the colour code at the end of the item reference.
Indiquer le code de couleur a la fin de la référence.
Angabe des Farbcodes am Ende der Artikelnummer.

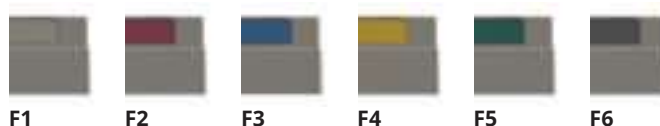

FLAP RACK®

 Ø max. 151 mm
9 COMPART.

**FLAP
RACK®**



REF	Δmax. (mm)	H (mm)*
P5090 E1F1	120	140
P5090 E2F1	160	180
P5090 E3F1	200	220
P5090 E4F1	240	260
P5090 E5F1	280	300

 Ø max. 113 mm
16 COMPART.

**FLAP
RACK®**



REF	Δmax. (mm)	H (mm)*
P5160 E1F1	120	140
P5160 E2F1	160	180
P5160 E3F1	200	220
P5160 E4F1	240	260
P5160 E5F1	280	300

 Ø max. 89 mm
25 COMPART.

**FLAP
RACK®**



REF	Δmax. (mm)	H (mm)*
P5250 E1F1	120	140
P5250 E2F1	160	180
P5250 E3F1	200	220
P5250 E4F1	240	260
P5250 E5F1	280	300

 Ø max. 73 mm
36 COMPART.

**FLAP
RACK®**



REF	Δmax. (mm)	H (mm)*
P5360 E1F1	120	140
P5360 E2F1	160	180
P5360 E3F1	200	220
P5360 E4F1	240	260
P5360 E5F1	280	300

 Ø max. 63 mm
49 COMPART.

**FLAP
RACK®**



REF	Δmax. (mm)	H (mm)*
P5490 E1F1	120	140
P5490 E2F1	160	180
P5490 E3F1	200	220
P5490 E4F1	240	260
P5490 E5F1	280	300

* Altura total del conjunto
* Total set height
* Hauteur totale lot
* Gesamthöhe des Sets

Indicar el código de color al final de la referencia.
Indicate the colour code at the end of the item reference.
Indiquer le code de couleur a la fin de la référence.
Angabe des Farbcodes am Ende der Artikelnummer.

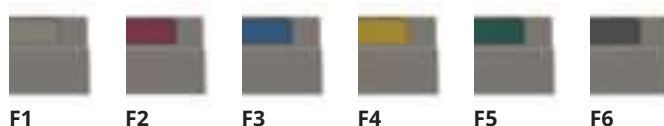

**FLAP
RACK®**

P5002 Cesta universal / Open rack / Panier universel / Universalspülkorb

FLAP RACK®



P5002



P5001

REF	
P5002	6
P5001	12
TRA*	12

P5001 Compatible sólo con las cestas FlapRack®. Compatible only with FlapRack® dishwasher racks. Compatible uniquement avec les casiers de lavage FlapRack®. Kompatibel nur mit den Körbe FlapRack®.

TRA* Compatible sólo con las cestas T-Version. Compatible only with T-Version dishwasher racks. Compatible uniquement avec les casiers de lavage T-Version. Kompatibel nur mit den Körbe T-Version.

P5000 Cesta para platos, bandejas y cubiertos / Plate, tray and cutlery baskets / Paniers pour plats, plateaux et couverts / Lagerbehälter und Körbe für Geschirr, Besteck und Tablett

FLAP RACK®

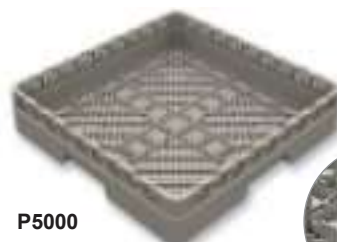

P5000

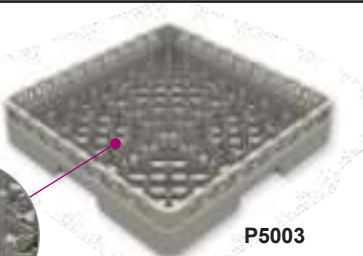

P5003

REF	
P5000	6
P5003	6

P5000 Cesta para cubiertos / Flatware rack / Panier a couverts / Besteckspülkorb

P5003 Cesta para platos y bandejas / Plates and trays rack / Panier pour assiettes et plateaux / Spülkorb für Teller und Tablett

TR33 Tapa para cestas / Rack lid / Couvercle pour panier / Spülkorbdeckel

FLAP RACK®



REF	
TR33	6

P5062 Cesta para almacenar cubiertos / Basket for cutlery storage / Panier pour rangement couverts / Besteckkorb

FLAP RACK®



REF				H (mm)*	Capacidad cubiertos / Cutlery storage / Capacité couverts / Korb für bestecke	
	max. (mm)					
P5062	23			26	400	1

*Altura total del conjunto
Total set height
Hauteur totale lot
Gesamthöhe des Sets

Media cesta para cubiertos / Flatware basket / Demi-panier pour couverts / Spülkorbeinsatz für Besteck

FLAP RACK®



P5018

P5019



52643

P5004

REF	
P5018	6
P5019	6
P5004	6
52643	12

P5018 Con asa / With handle
Avec anse / Mit griff

P5019 Sin asa / Without handle
Sans anse / Ohne Griff

P5004 Cestillo para cubiertos
Flatware basket
Petit panier pour couverts
Kleiner Spülkorbeinsatz für Besteck



CESTAS VAINILLA /
DISHWASHER RACKS /
CASERS/VASSELLE

FLAP RACK®

Cestas especiales para platos: Ideales para el lavado, almacenamiento y transporte de platos. Perfectas para banquetes, hoteles, colectividades y empresas de alquiler de material para la hostelería. Reducen las roturas de platos, minimizan el coste del transporte y manipulación.

Plate crate: Perfect dish washing, storing and transporting for banquets, hotels, institutions and catering equipment rental companies. They minimize the plate breakage, labour and handling cost.

Casiers pour assiettes: Idéales pour le lavage, stockage et transport d'assiettes. Parfaits pour banquets, hôtels, collectivités et sociétés de location de matériel pour l'hôtellerie. Ce type de casiers permet de réduire le nombre d'assiettes cassées ainsi qu'une diminution des coûts de transport et manipulation.

Spülkörbe speziell für teller: ideal für die Reinigung, lagerung und transport der teller. perfekt für banketts, hotels, catering und Firmen, die gastronomiematerial vermieten. Weniger zerbrochene Teller, Minimierung der Transport- und Abwicklungskosten.

Dos modalidades /
Two types /
Deux modèles /
Zwei Typen

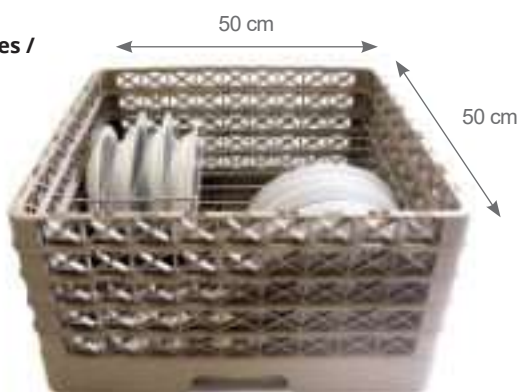

Limpieza y secado rápido.
Faster wash and rinse.
Propreté et séchage plus rapide.
Schnelle Reinigung und Trocknung.



Almacenamiento y transporte más seguro e higiénico.
More safety and hygienic storing and transporting.
Stockage et transport plus sûr et hygiénique.
Lagerung und Transport sicherer und hygienischer.

Nueve formatos de rejilla /
Nine different grids /
Neuf grilles différentes /
Neun Gitterformate

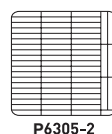
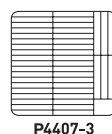
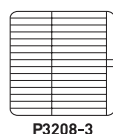
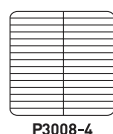
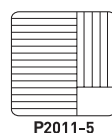

Mayor protección, resistencia y durabilidad.
Extra protection, strength and durability.
Plus grande protection, résistance et durabilité.
Extra Schutz, Resistenz und Langlebigkeit.

Como elegir la cesta de platos adecuada:
Debe medir el diámetro y altura del plato. Con estos datos escoger, de las 9 combinaciones posibles, aquella que se ajuste más a las medidas del plato.

How to chose the appropriate plate crate:
Measure the plate diameter and height. You have then to chose between the 9 different grids according to the measures you get previously.

Comment choisir le casier pour assiettes:
Mesurer le diamètre et l'hauteur de l'assiette. Selon ces mesures choisir entre le 9 possibles combinaisons de grille qui s'adapte au mieux.

Wie wählen Sie den geeigneten Tellerspülkorb:
Messen Sie den Diameter und die Höhe des Tellers. Mit diesen Massen wählen Sie eine von 9 verschiedenen Kombinationen aus, die sich am nächsten an die Masse der Teller anpasst.



P1412-6



**FLAP
RACK®**

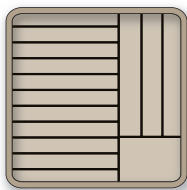

REF	I max. (cm)	Capacidad platos Capacity plates Capacité assiettes Tellerfassungsvermögen	
P1412-6	3,5	14	1
P1412-6 F1*	3,5	14	1

P1510-5

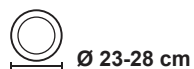

**FLAP
RACK®**

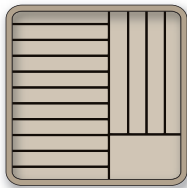

REF	I max. (cm)	Capacidad platos Capacity plates Capacité assiettes Tellerfassungsvermögen	
P1510-5	3,5	15	1
P1510-5 F1*	3,5	15	1

P1912-6

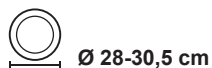

**FLAP
RACK®**

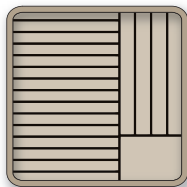

REF	I max. (cm)	Capacidad platos Capacity plates Capacité assiettes Tellerfassungsvermögen	
P1912-6	2,5	19	1
P1912-6 F1*	2,5	19	1

P2011-5



**FLAP
RACK®**

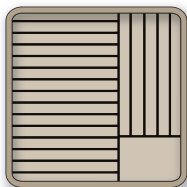

REF	I max. (cm)	Capacidad platos Capacity plates Capacité assiettes Tellerfassungsvermögen	
P2011-5	2,5	20	1
P2011-5 F1*	2,5	20	1

P2110-5



**FLAP
RACK®**

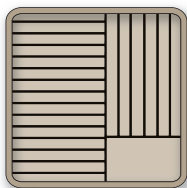

REF	I max. (cm)	Capacidad platos Capacity plates Capacité assiettes Tellerfassungsvermögen	
P2110-5	2,5	21	1
P2110-5 F1*	2,5	21	1

P3008-4



**FLAP
RACK®**

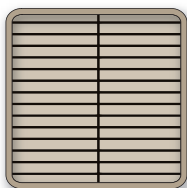

REF	I max. (cm)	Capacidad platos Capacity plates Capacité assiettes Tellerfassungsvermögen	
P3008-4	2,5	30	1
P3008-4 F1*	2,5	30	1

* Cestas cerradas
* Closed racks
* Paniers fermés
* Geschlossene Spülkörbe

Indicar el código de color al final de la referencia.
Indicate the colour code at the end of the item reference.
Indiquer le code de couleur a la fin de la référence.
Angabe des Farbcodes am Ende der Artikelnummer.

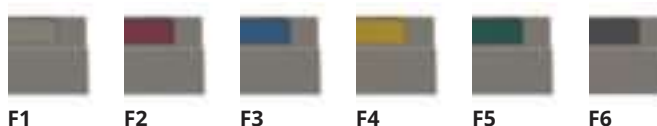

**FLAP
RACK®**

P3208-3



FLAP RACK

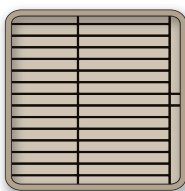

REF	max. (cm)	Capacidad platos Capacity plates Capacité assiettes Tellerfassungsvermögen	Icon
P3208-3	2,5	32	1
P3208-3 F1*	2,5	32	1

P4407-3



FLAP RACK

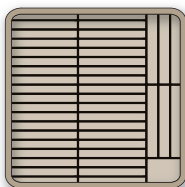

REF	max. (cm)	Capacidad platos Capacity plates Capacité assiettes Tellerfassungsvermögen	Icon
P4407-3	2	44	1
P4407-3 F1*	2	44	1

P6305-2

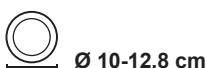

FLAP RACK

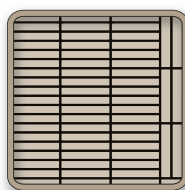

REF	max. (cm)	Capacidad platos Capacity plates Capacité assiettes Tellerfassungsvermögen	Icon
P6305-2	2,5	63	1
P6305-2 F1*	2,5	63	1

TR23 / TR30 Cesta para grandes bandejas / Open tray rack / Panier pour grands plateaux / Spülkorb für grosse tablett.

NSF T-VERSION



REF	H cm Interior / Inside / Intérieure / Beschreibung	H cm Exterior / Outside / Extérieure / Aussendurch	Icon
TR23*	13,3	13,3	1
TR30	8,3	10,2	1

* Capacidad para 4 bandejas extendidas de tamaño completo y también para bandejas isotérmicas Ref. 919000 (pag 220) Capacity for 4 full-size extended trays and also for isothermal trays Ref. 919000 (page 220) Capacité pour 4 plateaux longs de grande taille et également pour plateaux isothermes Réf. 919000 (page 220). Bietet Platz für 4 Tablett in voller Größe und auch für isotherme Tablett Ref. 919000 (S. 220)

TR21 / TR22 Cesta para bandejas isotérmicas, GN y platos / GN, isothermal trays and plates rack / Panier pour plateaux isothermes, GN et assiettes / Spülkorb für isothermische tablett, GN und teller

NSF T-VERSION

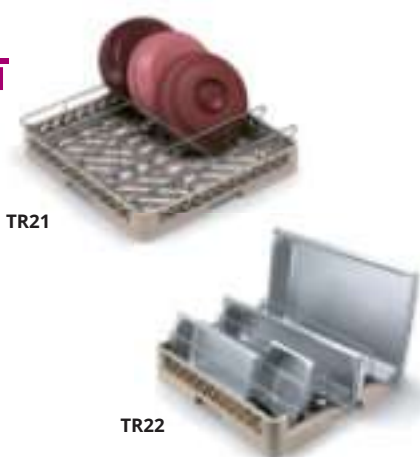

REF	H cm Interior / Inside / Intérieure / Beschreibung	H cm Exterior / Outside / Extérieure / Aussendurch	Icon
TR21	8,3	12,1	1
TR22	13,3	13,3	1

TR21 8 Compartimentos / Compartiments / Compartiments / Fächer 80 mm Distancia entre compart. / Distance between compart. / Distance entre compart / Fächerabstand No aptas para bandejas isotérmicas / Not suitable for isothermal trays / Ne convient pasaux bacsisothermiques/ Nicht für isothermische Tablett geeignet. Ref. 919000 (pag 220) TR22 5 Compartimentos / Compartiments / Compartiments / Fächer 75 mm Distancia entre compart. / Distance between compart. / Distance entre compart / Fächerabstand Ideal para bandejas isotérmicas / Ideal for isothermal trays / Idéal pour plateaux isothermes / Ideal für isotherme Tablett Ref. 919000 (pag 220)

Cesta de extremo abierto / Open end rack / Casierouvert à l'extrémité / Offener Korb

* Cestas cerradas / Closed racks / Paniers fermés / Geschlossene Spülkörbe

Indicar el código de color al final de la referencia. Indicate the colour code at the end of the item reference. Indiquer le code de couleur a la fin de la référence. Angabe des Farbcodes am Ende der Artikelnummer.

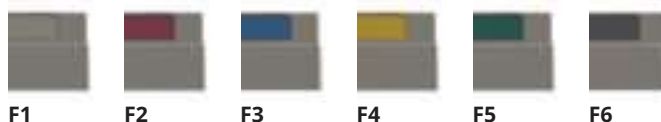

FLAP RACK

GUÍA DE SELECCIÓN PARA BASES Y EXTENSIONES /
REFERENCE GUIDE FOR BASES AND EXTENSIONS /
GUIDE DE SELECTION POUR BASES ET EXTENTIONS /
AUSWAHLÜBERSICHT FÜR DIE BASIS UND VERGRÖßERUNGEN

ALTURA DE LAS CESTAS DE TAMAÑO COMPLETO /
HEIGHT OF FULL-SIZE RACKS /
HAUTEUR DES CASIERSGRANDE TAILLE /
SPÜLKORB-HÖHE (HALBGRÖSSE)

ALTURA DE LAS CESTAS DE MEDIO TAMAÑO /
HEIGHT OF HALF-SIZE RACKS /
HAUTEUR DES CASIERSDEMI-TAILLE /
SPÜLKORB-HÖHE (STANDARDGRÖSSE)

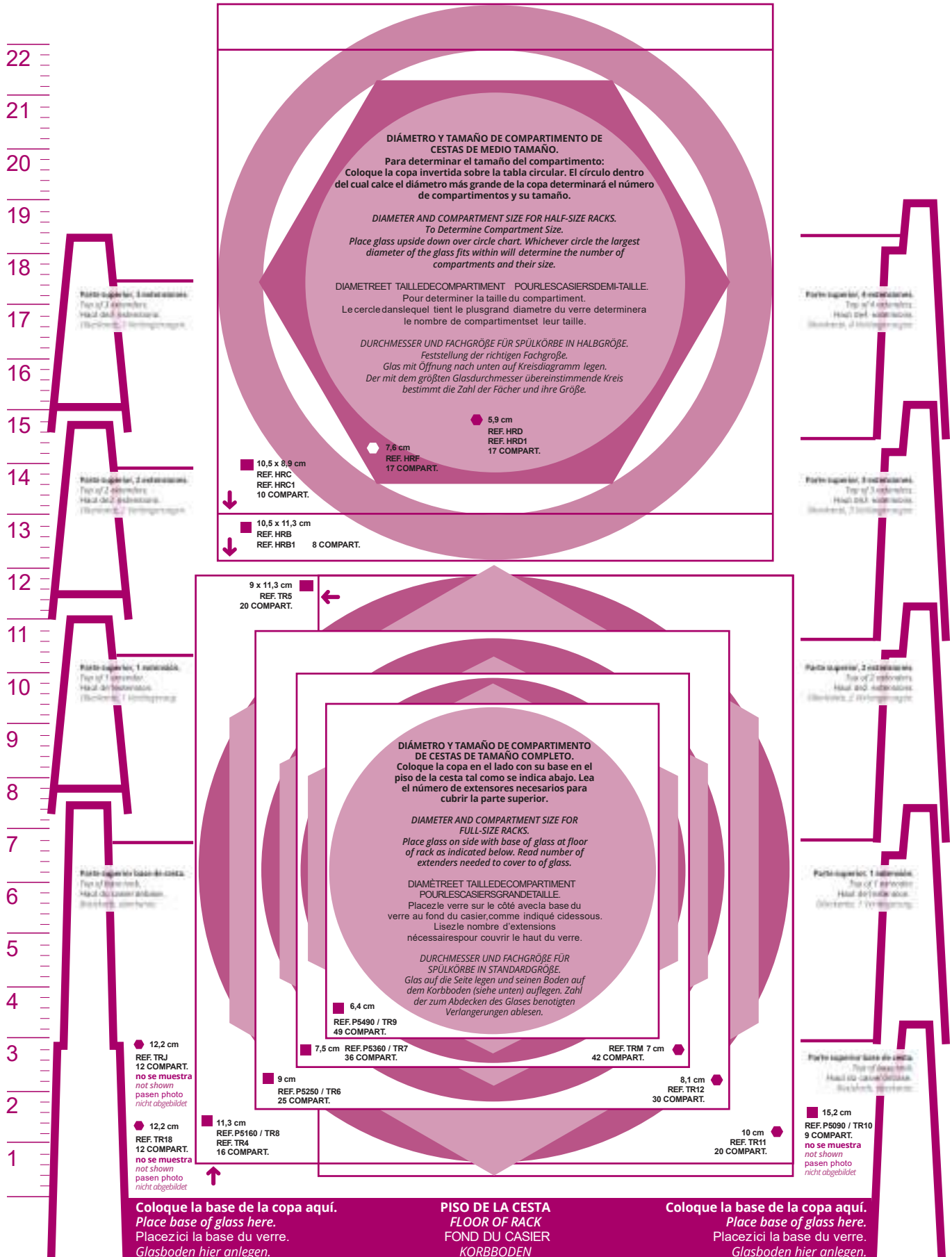

CESTAS VANILLA /
 DISHWASHER RACKS /
 CASIERSVANILLE



10.1	CARROS DE SERVICIO ALUMINIO / <i>ALUMINIUM SERVING TROLLEYS /</i> CHARIOTS DE SERVICE EN ALUMINIUM / <i>SERVICWAGEN AUS ALUMINIUM</i>	246
10.2	CARROS DE SERVICIO ACERO INOXIDABLE / <i>ST/STEEL SERVING TROLLEYS /</i> CHARIOTS DE SERVICE EN ACIER INOXYDABLE / <i>SERVIERWAGEN AUS EDELSTAHL</i>	247
10.3	CARROS GUÍAS EN ACERO INOXIDABLE / <i>ST/STEEL RAIL TROLLEYS /</i> CHARIOTS À GLISSIÈRE EN ACIER INOXYDABLE / <i>SERVIERWAGEN MIT EINSCHÜBEN AUS EDELSTAHL</i>	251
10.4	CARROS ESPECIALES / SPECIAL TROLLEYS / CHARIOTS SPÉCIAUX / SPEZIALWAGEN	257

P8090 Carro aluminio desembarace / Aluminium clearing trolley /
Chariot débarrassage en aluminium / Aluminium Abräumwagen

EXCLUSIVE



REF	
P80.900	1

Medidas de estantes adaptables a cubetas GN 1/1 y cestas FLAP-RACK® (500 x 500 mm). Carga máxima: total 150 Kg y con un máximo de 75 Kg por estante.

Racks adjustable to 1/1 GN containers and FLAP-RACK® (500 x 500 mm). Maximum load: 150 Kg and max. per level 75 Kg.

Clayettes adaptables à des bacs GN 1/1 et à casiers à vaisselle FLAP-RACK® (500 x 500 mm). Charge maximale: total 150 Kg et 75 Kg par niveau.

Masse der regale passend für GN behälter 1/1 und FLAP-RACK® spülkörbe (500 x 500 mm). Maximale tragkraft: total 150 Kg und maximal 75 Kg pro regal.

P6411 Carro de servicio / Trolley / Chariot de service / Servierwagen



REF	Dim. Estante / Shelf dimension / Dim. Niveau / Regalgröße mm	
P641.100	780 x 485	1

Carga máxima 120 kgs
Maximum weight load 120 kgs
Charge maximale 120 kgs
Maximale Tragkraft 120 kg

Soportes de aluminio
Aluminium supports
Supports en aluminium
Aluminiumständer

P642 / P643 Contenedor para cubiertos / Silverware container / Conteneur pour couverts / Besteckkasten
Contenedor para desperdicios / Refuse container / Conteneur pour déchets / Abfalleimer



REF	cm	Lts	
P642.000	32 x 19,5 x 16,5	9,00	1
P643.000	33,5 x 23 x 56	80,00	1

P640 Conjunto carro / Set trolley / Ensemble chariot / Servierwagen set

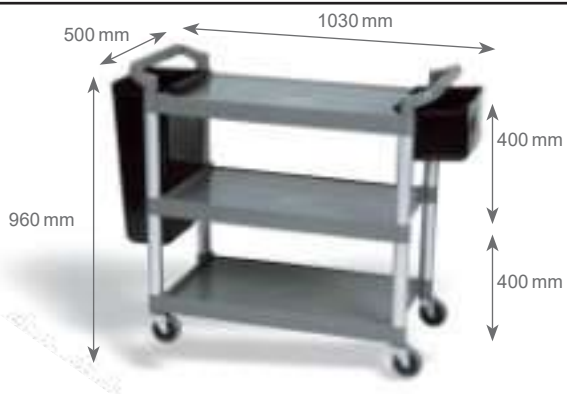

REF	Dim. Estante / Shelf dimension / Dim. Niveau / Regalgröße mm	
P640.000	780 x 485	1

Estructura tubular en acero inox de 1.5 mm espesor /
1.5 mm thick St/Steel tubular frame /
Structure tubulaire en acier inoxydable 1.5 mm. épaisseur /
Struktur aus Edelsathtrohr von 1,5 mm Dicke.



Carga máxima total 240 KG. Carga máxima por estante 80 kg /
Total maximum load 240 kg. Max. load per level 80 kg /
Charge maximale total 240 kg. Charge maximale per niveau 80 kg /
Maximale Tragkraft: Total 240 KG und max 80 KG pro regal.

Ruedas giratorias de 12 cm diámetro. Dos con frenos /
12 Cm diam. Revolving casters. Two with brakes /
Roues giratoires de 12 cm diam. Deux avec freins /
Drehbare räder 12 cm durchmesser. Zwei mit bremsvorrichtung



P8024 Carro servicio acero inox / St/steel serving trolley /
Chariot service en acier inox / Servierwagen Edelstahl

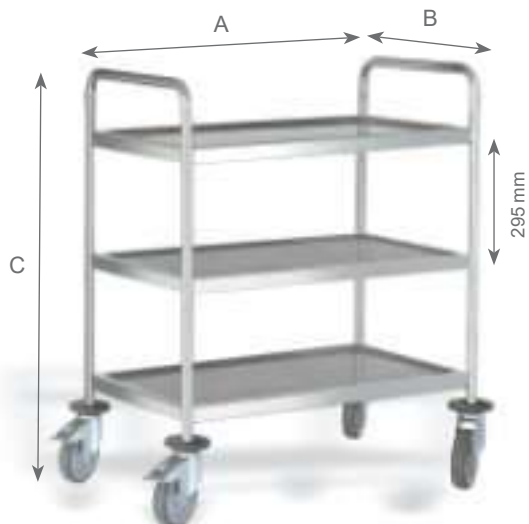
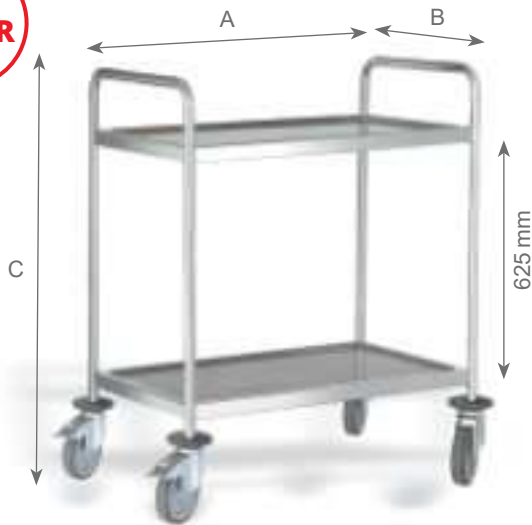

REF	Estantes / Levels / Niveaux / Regale	Dim. Estante / Shelf dimension / Dim. Niveau / Regalgröße mm	A x B x Cmm	
P80.240	2	800 x 500	880 x 580 x 1015	1
P80.250	2	900 x 500	980 x 580 x 1015	1
P80.260*	2	1000 x 600	1080 x 680 x 1015	1
P80.270	3	800 x 500	880 x 580 x 1015	1
P80.280	3	900 x 500	980 x 580 x 1015	1
P80.290*	3	1000 x 600	1080 x 680 x 1015	1
P80.300	4	800 x 500	880 x 580 x 1300	1
P80.310	4	900 x 500	980 x 580 x 1300	1
P80.320*	4	1000 x 600	1080 x 680 x 1300	1

*Estantes de chapa de mayor espesor / Thicker shelves /
Plateaux plus épais / Regal aus dickerem Blech.

Disponible también con ruedas poliamida. Consultar precio.
Available also on polyamide casters. Please ask for price.
Disponible aussi avec roulettes polyamide. Consulter prix.
Auch lieferbar mit Polyamidrädern. Bitte Preis nachfragen.

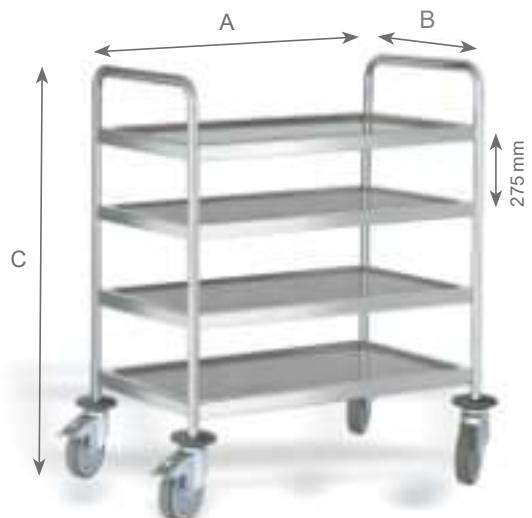

Estructura tubular en acero inox de 1.5 mm espesor /
1.5 mm thick St/Steel tubular frame /
Structure tubulaire en acier inoxydable 1.5 mm. épaisseur /
Struktur aus Edelsathlrohr von 1,5 mm Dicke.

Panelado / Paneled /
Panelé / Paneel



Carga máxima total 240 KG. Carga máxima por estante 80 kg /
Total maximum load 240 kg. Max. load per level 80 kg /
Charge maximale total 240 kg. Charge maximale per niveau 80 kg /
Maximale Tragkraft: Total 240 KG und max 80 KG pro regal.

Ruedas giratorias de 12 cm diámetro. Dos con frenos /
12 Cm diam. Revolving casters. Two with brakes /
Roues giratoires de 12 cm diam. Deux avec freins /
Drehbare räder 12 cm durchmesser. Zwei mit bremsvorrichtung

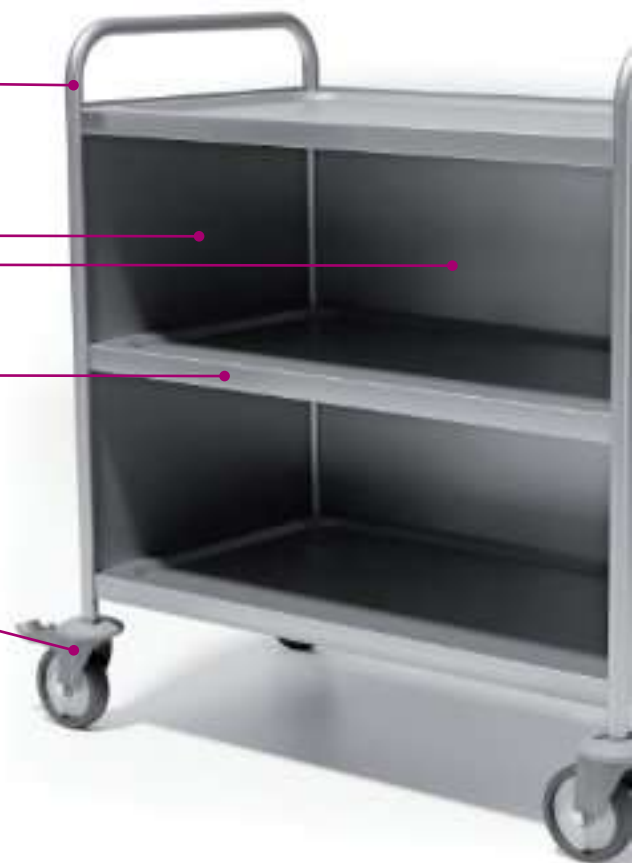

P80281 Carro servicio panelado / Paneled serving trolley /
Chariot service panelé / Paneel-Servierwagen mit Vordertüren.



REF	Estantes / Levels / Niveaux/ Regale	Dim. Estante / Shelf dimension / Dim. Niveau / Regalgröße mm	A x B x C mm	
P80.282	3	900 x 500	980 x 580 x 1015	1

Ver productos en / See products on / Voir produits en page / Siehe produkte in

P.
429

CARRO MADERA PRESENTACIÓN BUFFET /
WOODEN BUFFET SERVING TROLLEY /
CHARIOT BUFFET EN BOIS PRÉS.BUFFET /
BUFFETSERVIERWAGEN AUS HOLZ





Carga máxima total 240 KG. Carga máxima por estante 80 kg /
Total maximum load 240 kg. Max. load per level 80 kg /
Charge maximale total 240 kg. Charge maximale per niveau 80 kg /
Maximale Tragkraft: Total 240 KG und max 80 KG pro regal.

Ruedas giratorias de 12 cm diámetro. Dos con frenos /
12 Cm diam. Revolving casters. Two with brakes /
Roues giratoires de 12 cm diam. Deux avec freins /
Drehbare räder 12 cm durchmesser. Zwei mit bremsvorrichtung



P8033 Carro desmontable / Disassembled trolley / Chariot démontable / Demontierbarer Servierwagen

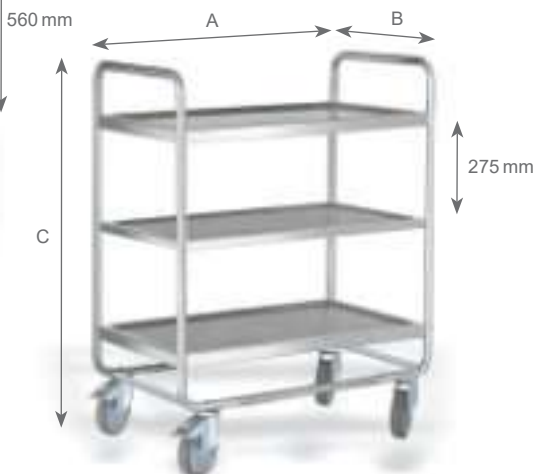
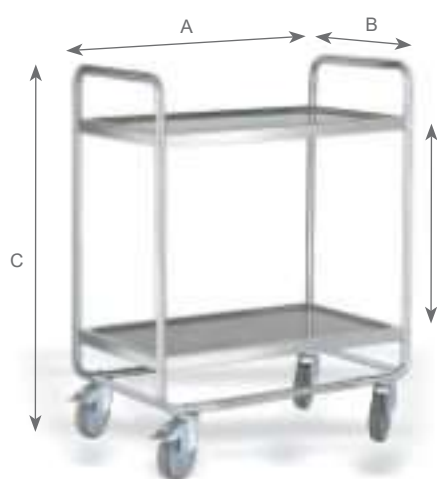

REF	Estantes / Levels / Niveaux / Regale	Dim. Estante / Shelf dimension / Dim. Niveau / Regalgröße mm	A x B x C mm	
P80.330	2	800 x 500	810 x 545 x 1040	1
P80.340	2	900 x 500	910 x 545 x 1040	1
P80.350	3	800 x 500	810 x 545 x 1040	1
P80.360	3	900 x 500	910 x 545 x 1040	1



**MONTAJE / ASSEMBLY /
MONTAGE / MONTAGE**

Se entregan desmontados. Muy
robustos y sólidos /

Delivered flatpacked. Very strong and
resistant once assembled /

Livrés démontés. Très robustes et
solides une fois montés /

Lieferung Unmontiert. einmal montiert sind
sie Sehr robust und solide

P8096 Carro desmontable ligero / Light disassembled trolley /
Chariot démontable légère / Leichter demontierbarer Servierwagen



REF	Estantes / Levels / Niveaux / Regale	Dim. Estante / Shelf dimension / Dim. Niveau / Regalgröße mm	
P80.960	2	830 x 510	1
P80.961	3	830 x 510	1

**Ruedas acero Ø 100 mm.
Dos con freno.**

Castors Ø 100 mm.
Two with brakes.

Roulettes Ø 100 mm.
Deux avec freins.

Edelstahlräder Ø 100 mm.
Zwei mit Bremsen.

**GAMA ECONÓMICA /
ECONOMIC LINE /
GAMME ECONOMIQUE /
ÖKONOMISCHE SERIE**

10.2 CARROS / TROLLEYS / CHARIOTS/ SERVIERWAGEN

**CARRO SERVICIO ACERO INOXIDABLE / ST/STEEL SERVING TROLLEY /
CHARIOT SERVICEENACIERINOXYDABLE / SERVIERWAGEN AUS EDELSTAHL**

**CARROS DE SERVICIO SOLDADOS / WELDED SERVING TROLLEYS /
CHARIOTS DE SERVICESOUDÉS/ GESCHWEISSTE SERVIERWAGEN**

P8094 Carro servicio con barandilla / Serving trolley with guard-rail shelf / Chariot service avec galerie / Servierwagen mit Geländer



REF	Estantes / Levels / Niveaux/ Regale	Dim. Estante / Shelf dimension / Dim. Niveau / Regalgröße mm	
P80.940	2	800 x 500	1
P80.941	3	800 x 500	1

Disponible también con ruedas poliamida. Consultar precio /

Available also on polyamide castors. Please ask for price /

Disponible aussi avec roulettes polyamide. Consulter prix /

Auch lieferbar mit Polyamidrädern. Bitte Preis nachfragen.

P8068 Carro desembarace inox / St/Steel clearing trolley / Chariot de débarrasse en inox / Abräumwagen



REF	Estantes / Levels / Niveaux/ Regale	Dim. Estante / Shelf dimension / Dim. Niveau / Regalgröße mm	
P80.680	2	1.000 x 600	1

Disponible también con ruedas poliamida. Consultar precio.
Available also on polyamide castors. Please ask for price.
Disponible aussi avec roulettes polyamide. Consulter prix.
Auch lieferbar mit Polyamidrädern. Bitte Preis nachfragen.

No incluye cubeta Gastronorm 1/2.
1/2 Gastronorm container not included.

BacGastronorme 1/2 non inclus.
1/2 Gastronorm Behälter nicht im Preis inklusive.

Ø 165 mm

P80374 Cubertero para carro servicio / Cutlery dispenser for serving trolley / Ramasse-couverts pour chariot service / Behälter für Servicewagen



REF	Mod	H mm	
P80.374	GN 1/3	150	1

P8043 Carro 17 guías GN 1/1 / 17 rails trolley for 1/1 GN pans /
Chariot 17 glissières pour bacs GN 1/1 / Servierwagen mit 17 Einschüben für GN 1/1



REF	
P80.430	1

Entrada 325 mm
Entrance 325 mm
Entrée 325 mm
Eingang 325 mm

Disponible también con ruedas poliamida. Consultar precio.
Available also on polyamide castors. Please ask for price.
Disponible aussi avec roulettes polyamide. Consulter prix.
Auch lieferbar mit Polyamidrädern. Bitte Preis nachfragen.

P8067 Carro doble 17 x 2 guías 1/1 / Double rail trolley 17 x 2 for 1/1 GN pans /
Chariot double 17 x 2 glissières pour bacs GN 1/1 / Doppelservierwagen mit 17 x 2 Einschüben für GN 1/1



REF	
P80.670	1

Entrada 325 mm
Entrance 325 mm
Entrée 325 mm
Eingang 325 mm

Disponible también con ruedas poliamida. Consultar precio.
Available also on polyamide castors. Please ask for price.
Disponible aussi avec roulettes polyamide. Consulter prix.
Auch lieferbar mit Polyamidrädern. Bitte Preis nachfragen.

CARROS /
TROLLEYS /
CHARIOTS

Ver productos en / See products on / Voir produits en page / Siehe produkte in

P.
84

P.
86

BANDEJAS GN Y PASTERÍA /
GN AND BAKING SHEET PANS /
PLAQUES GN ET PÂTISSERIE /
GN-TABLETTS UND BACKWAREN



P8052 Carro encastrable 17 guías GN 1/1 / Stackable trolley 17 rails for 1/1 GN pans /
Chariot emboîtable 17 glissières pour bacs GN 1/1 / Klappbarer Servierwagen mit 17 Einschüben für GN 1/1



REF	
P80.520	1

Entrada 325 mm
Entrance 325 mm
Entrée 325 mm
Eingang 325 mm

Disponibile también con ruedas poliamida. Consultar precio.
Available also on polyamide castors. Please ask for price.
Disponibile aussi avec roulettes polyamide. Consulter prix.
Auch lieferbar mit Polyamidrädern. Bitte Preis nachfragen.

P8047 Carro desmontable 17 guías GN 1/1 / Disassembled trolley 17 rails for 1/1 GN pans /
Chariot démontable 17 glissières pour bacs GN 1/1 / Demontierbarer Servierwagen mit 17 Einschüben für GN 1/1

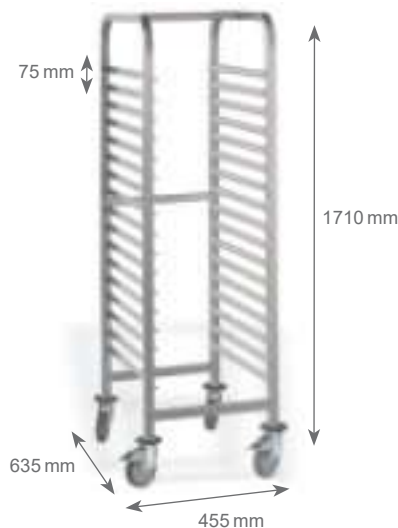

REF	
P80.470	1

Entrada 325 mm
Entrance 325 mm
Entrée 325 mm
Eingang 325 mm

Disponibile también con ruedas poliamida. Consultar precio.
Available also on polyamide castors. Please ask for price.
Disponibile aussi avec roulettes polyamide. Consulter prix.
Auch lieferbar mit Polyamidrädern. Bitte Preis nachfragen.

P8097 Carro desmontable ligero 15 guías GN 1/1 /
Light Disassembled trolley 15 rails for 1/1 GN pans /
Chariot démontable léger 15 glissières pour bacs GN 1/1 /
Leichter Demontierbarer Servierwagen mit 15 Einschüben für GN 1/1



REF	
P80.970	1

Entrada 325 mm
Entrance 325 mm
Entrée 325 mm
Eingang 325 mm

Ruedas acero Ø 120 mm. Dos con freno.
Castors Ø 120 mm. Two with brakes.
Roulettes Ø 120 mm. Deux avec freins.
Edelstahlrollen Ø 120 mm. Zwei mit Bremsen.

**GAMA ECONOMICA /
ECONOMIC LINE /
GAMME ECONOMIQUE /
ÖKONOMISCHE SERIE**

P8044 Carro 17 guías GN 2/1 / 17 rails trolley for 2/1 GN pans /
Chariot 17 glissières pour bacs GN 2/1 / Servierwagen mit 17 Einschüben für GN 2/1



REF	
P80.440	1 

Entrada 530 mm
Entrance 530 mm
Entrée 530 mm
Eingang 530 mm

Disponible también con ruedas poliamida. Consultar precio.
Available also on polyamide castors. Please ask for price.
Disponible aussi avec roulettes polyamide. Consulter prix.
Auch lieferbar mit Polyamidrädern. Bitte Preis nachfragen.

P8048 Carro desmontable 17 guías GN 2/1 / Disassembled trolley 17 rails for 2/1 GN pans /
Chariot démontable 17 glissières pour bacs GN 2/1 / Demontierbarer Servierwagen mit 17 Einschüben für GN 2/1



REF	
P80.480	1 

Entrada 530 mm
Entrance 530 mm
Entrée 530 mm
Eingang 530 mm

Disponible también con ruedas poliamida. Consultar precio.
Available also on polyamide castors. Please ask for price.
Disponible aussi avec roulettes polyamide. Consulter prix.
Auch lieferbar mit Polyamidrädern. Bitte Preis nachfragen.

Desmontado /
Flat packed /
Livré démonté /
Demontiert

P8051 Carro encastrable 17 guías GN 2/1 / Stackable trolley 17 rails for 2/1 GN pans /
Chariot emboîtable 17 glissières pour bacs GN 2/1 / Klappbarer Servierwagen mit 17 Einschüben für GN 2/1



Encastrable / Stackable /
Emboîtable / Klappbarer



REF	
P80.510	1 

Entrada 530 mm
Entrance 530 mm
Entrée 530 mm
Eingang 530 mm

Disponible también con ruedas poliamida. Consultar precio.
Available also on polyamide castors. Please ask for price.
Disponible aussi avec roulettes polyamide. Consulter prix.
Auch lieferbar mit Polyamidrädern. Bitte Preis nachfragen.

P8084 / P8085 / P8046 Carro pastelería / Pastry trolley / Chariot pâtisserie / Pâtisserieswagen



REF	Medida guías / Size of rails / Dimensions glissières / Einschubgrößen	Nº Guías / Nr. of Levels / Num. Niveaux / Nr. Einschübe	Distancia entre guías / Distance between levels / Espacedentre niveaux / Einschubabstände	1
	mm		mm	
P80.840	600 x 400	15	85	1
P80.850	600 x 400	20	70	1
P80.460	600 x 400	30	45	1

Entrada 400 mm
Entrance 400 mm
Entrée 400 mm
Eingang 400 mm

Disponible también con ruedas poliamida. Consultar precio.
Available also on polyamide castors. Please ask for price.
Disponible aussi avec roulettes polyamide. Consulter prix.
Auch lieferbar mit Polyamidrädern. Bitte Preis nachfragen.

**Carro desmontable bandejas pastelería /
Disassembled rail trolley for bakery /**

Chariots démontable pour plaques à pâtisserie /
Demontierbarer Wagen für Pâtisseries-Tabletts

P8087 / P8088 / P8050



REF	Medida guías / Size of rails / Dimensions glissières / Einschubgrößen	Nº Guías / Nr. of Levels / Num. Niveaux / Nr. Einschübe	Distancia entre guías / Distance between levels / Espacedentre niveaux / Einschubabstände	1
	mm		mm	
P80.870	600 x 400	15	85	1
P80.880	600 x 400	20	70	1
P80.500	600 x 400	30	45	1

Entrada 400 mm
Entrance 400 mm
Entrée 400 mm
Eingang 400 mm

Disponible también con ruedas poliamida. Consultar precio.
Available also on polyamide castors. Please ask for price.
Disponible aussi avec roulettes polyamide. Consulter prix.
Auch lieferbar mit Polyamidrädern. Bitte Preis nachfragen.



**Desmontado / Flat packed /
Livré démonté / Demontiert**

P8081 Carro descongelación 9 guías / Defrost trolley 9 rails /
Chariot à dégivrage 9 glissières / Auftauwagen mit 9 Einschüben

PATENTED / EXCLUSIVE



REF	Mod	A x B x C mm	
P80.810	GN 2/1	665 x 755 x 1720	1
P80.813	GN 1/1	455 x 635 x 1720	1

Ahorro de espacio en el proceso de descongelado de los alimentos.

*Space saver while foodstuff defrost.
Economie d'espace pendant le dégivrage des aliments.
Platzsparend im Auftauverfahren von Lebensmitteln.*

Disponible también con ruedas poliamida. Consultar precio.

*Available also on polyamide castors. Please ask for price.
Disponible aussi avec roulettes polyamide. Consulter prix.
Auch lieferbar mit Polyamidrädern. Bitte Preis nachfragen.*

P80811 Cubeta especial GN para carro descongelación / Special GN container for defrost trolley /
Bac GN spécial pour chariot dégivrage / Spezial GN Behälter zum Auftauen



REF	Mod	mm	Lts	H mm	
P80.811	GN 2/1	650 x 530	28,90	100,0	1
P80.814	GN 1/1	530 x 325	14,20	100,0	1

Cubeta con desagüe.
*Container with drainer hole.
Bac avec dégorgeement.
Behälter mit Abwasserloch.*

P215 / P115 Fondo perforado para cubeta / Perforated bottom /
Egouttoir pour bac / Gelochter Einlegeboden für Behälter



REF	Mod	
P215.000 ¹	GN 2/1	1
P115.000 ²	GN 1/1	1

¹ Recomendado para ref. P80811
*Recommended for item code P80811
Recommandé pour réf. P80811
Empfohlen für Art.Nr. P80811*

² Recomendado para ref. P80814
*Recommended for item code P80814
Recommandé pour réf. P80814
Empfohlen für Art.Nr. P80814*

Ver productos en / See products on / Voir produits en page / Siehe produkte in

P.
88

REJILLA / GRIDS /
GRILLES/ ROSTE



P8095 Carro self-service 12 guías / Self-service trolley 12 rails /
Chariot self-service 12 glissières / Selbstbedienungswagen 12 Einschübe

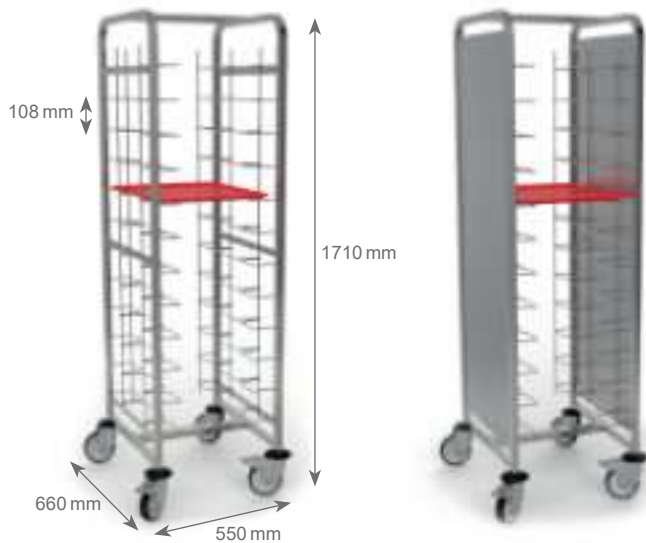

REF		
P80.950		1
P80.951*		1

Para bandejas de ancho 365 mm hasta 420 mm
For trays from 365 mm to 420 mm width
Pour plateaux de 365 mm à 420 mm
Für Tablett's der Breite von 365 mm bis 420 mm.

- * Con dos paneles laterales composite+aluminio.
- * With two side panels made of aluminium+composite.
- * Avec deux panneaux latéraux en composite+aluminium.
- * Mit zwei Seitenwänden aus composite+Aluminium.

Ver productos en / See products on /
Voir produits en page / Siehe produkte in

P.
224

BANDEJAS DE POLIPROPILENO PARA
COMIDA RÁPIDA /
POLYPROPYLENE FAST FOOD TRAYS /
PLATEAUX DE RESTAURATION
RAPIDE EN POLYPROPYLENE /
POLYPROPYLEN - IMBISSTABLETT'S



P8091 Carro doble para bandejas fast-food 12 guías / Double fast-food tray trolley 12 rails /
Chariot double pour plateaux fast-food 12 glissières / Doppelwagen für Fast-Food Tablett's 12 Einschübe



REF	Medida guías / Size of rails / Dimensions glissières / Einschubgrößen	
	mm	
P80.910	480 x 800	1

Entrada 480 mm
Entrance 480 mm
Entrée 480 mm
Eingang 480 mm

Ideal para bandejas 480 x 370 mm
Suitable for trays 480 x 370 mm
Ideal pour plateaux 480 x 370 mm
Ideal für Tablett's 480 x 370 mm

Disponible también con ruedas poliamida. Consultar precio.
Available also on polyamide castors. Please ask for price.
Disponible aussi avec roulettes polyamide. Consulter prix.
Auch lieferbar mit Polyamidrädern. Bitte Preis nachfragen.

P925 Carro transporte bandejas isotérmicas / Transport trolley for isothermal trays /
Chariot transport plateaux isothermes / Transportwagen für isothermische Tablett's



REF	Medida guías / Size of rails / Dimensions glissières / Einschubgrößen	Nº Guías / Nr. of Levels / Num.Niveaux / Nr. Einschübe	
	mm		
P925.001	550 x 375	10	1
P925.002	550 x 375	20	1

Carro fabricado en acero inoxidable y guías de plástico. Ideal para el transporte de bandejas de distintas medidas, gracias al diseño especial de sus guías. Ruedas giratorias insonoras de Ø 125 mm.

Chariot fabriqué en acier inoxydable et glissières en plastique. Idéal pour le transport des plateaux de différentes mesures, grâce au design spécial des glissières. Roulettes insonores de Ø 125 mm.

Trolley made of St/Steel and plastic rails. Perfect for many different size trays transport thanks to the special rail design. Soundproof revolving castors Ø 125 mm.

Wagen hergestellt aus rostfreiem Stahl mit Plastikeinschüben. Ideal für den Transport von Tablett's verschiedener Größen, dank seinem speziellen Design der Einschübe. Geräuschlose drehbare Räder Ø 125 mm.

P8039 Carro porta cubetas GN / GN containers transport trolley /
Chariot transport bacs GN / Transportwagen für GN Behälter



REF	
P80.390	1

No incluye cubetas GN.
GN containers not included.
Bacs GN non inclus.
GN Behälter nicht inklusive.

Disponible también con ruedas poliamida. Consultar precio.
Available also on polyamide castors. Please ask for price.
Disponible aussi avec roulettes polyamide. Consulter prix.
Auch lieferbar mit Polyamidrädern. Bitte Preis nachfragen.

P8038 Carro porta cubeta GN 2/1 / 2/1 GN transport trolley /
Chariot transport bac GN 2/1 / Transportwagen für GN Behälter 2/1



REF	
P80.380	1

No incluye cubetas GN.
GN containers not included.
Bacs GN non inclus.
GN Behälter nicht inklusive.

Disponible también con ruedas poliamida. Consultar precio.
Available also on polyamide castors. Please ask for price.
Disponible aussi avec roulettes polyamide. Consulter prix.
Auch lieferbar mit Polyamidrädern. Bitte Preis nachfragen.

REF.P80.390 / P80.380
Carro transporte para cubetas GN
Transport trolley for GN containers
Chariots de transport pour bacs GN
Transportwagen für GN behälter

Fabricados en acero inoxidable. Ideales para el almacenaje y transporte de alimentos preparados y salsas en grandes cantidades.
Made of St/Steel. Perfect for storing and transporting large quantities of prepared food and sauces.
Fabriqués en acier inoxydable. Idéales pour le stockage et le transport d'aliments cuisinés et sauces en grandes quantités.
Hergestellt aus Edelstahl. Ideal für die Lagerung und den Transport von vorbereiteten Lebensmittel und Sossen in grossen Mengen.

P8074 Carro portacubiertos GN 1/3 y porta bandejas / Trolley cutlery dispenser GN 1/3 /
Chariot porte-ramasse couverts GN 1/3 / Transportwagen für GN 1/3 Besteckbehälter und Tablett



REF	
P80.740	1

No incluye cubetas GN.
GN containers not included.
Bacs GN non inclus.
GN Behälter nicht inklusive.

Disponible también con ruedas poliamida. Consultar precio.
Available also on polyamide castors. Please ask for price.
Disponible aussi avec roulettes polyamide. Consulter prix.
Auch lieferbar mit Polyamidrädern. Bitte Preis nachfragen.

P8057 Carro para cargas pesadas / Trolley for heavy loads /
Chariot à charges lourdes / Wagen für schwere Last



REF		
P80.570		1

Carga máxima: 350 kg
Maximum load: 350 kg
Charge maximale: 350 kg
Maximale Tragkraft: 350 kg

P8054 Carro transporte bandejas 7 guías / Tray transport trolley 7 rails /
Chariot transport plateaux 7 glissières / Tabletttransportwagen 7 Einschübe

REF	Medida guías / Size of rails / Dimensions glissières / Einschubgrößen mm	A x B x C mm	Distancia entre guías / Distance between levels / Espace entre niveaux / Einschubabstände mm	
P80.540	GN 1/1	455 x 635 x 900	75	1
P80.550	GN 2/1	660 x 750 x 900	75	1
P80.560	Pastelería / Pastry / Pâtisserie / Pâtisserie (600 x 400 mm)	525 x 700 x 900	85	1
P80.780	GN 1/1 Doble	810 x 635 x 900	75	1

Ref. P80.540

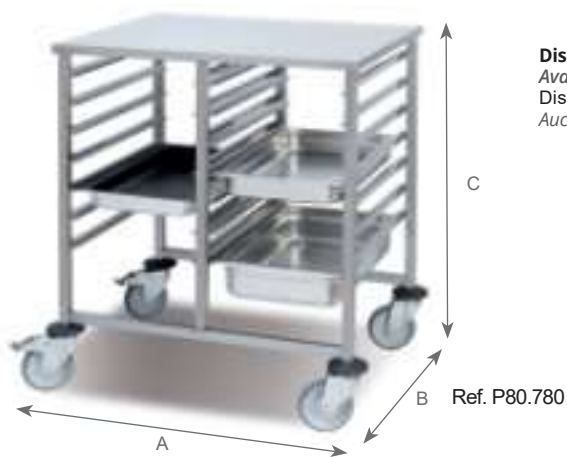

Disponible también con ruedas poliamida. Consultar precio.
Available also on polyamide castors. Please ask for price.
Disponible aussi avec roulettes polyamide. Consulter prix.
Auch lieferbar mit Polyamidrädern. Bitte Preis nachfragen.

Fundas desechables de polietileno para carros (rollo de 100 unidades) /
Disposable covers for trolleys (pack 100 pieces) /

P8061 / P8062 / P8063 Housses jetables pour chariots (rouleau de 100 unités) /
Einweghüllen aus Polyethylen für Wagen (Rollen von 100 Stück)





REF		
P80.610	para carro 1/1 / for trolley 1/1 / pour chariot 1/1 / für Wagen 1/1	1
P80.620	para carro 2/1 / for trolley 2/1 / pour chariot 2/1 / für Wagen 2/1	1
P80.630	para carro pastelería 600 x 400 / for pastry trolley 600 x 400 / pour chariot pâtisserie 600 x 400 / für Pâtisserieswagen 600 x 400	1
P80.640	dispensador / dispenser / distributeur / Rollenhalter	1

Poliétileno de densidad media.
Medium density polyethylene.
Poliéthylène de densité moyenne.
Polyethylen mittlere Stärke.

Para carros altos.
For high trolleys.
Pour chariots hauts.
Für hohe Wagen.

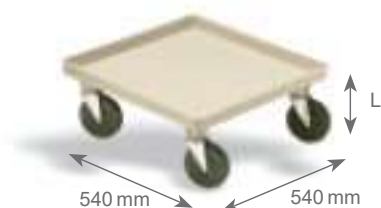
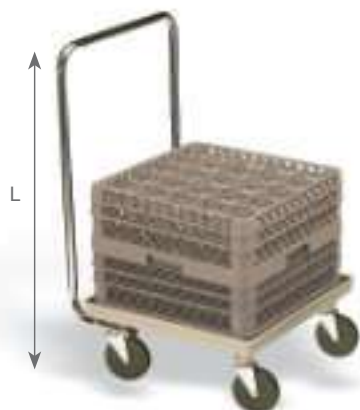
P5015 / P5017 Carro de plástico para cestas / Plastic trolley for dishwasher racks /
Chariot pour casiers à vaisselle / Plastikwagen für Spülkörbe



REF		L mm	
P5015	sin asa / without handle / sans anse / ohne Griff	230	1
P5017	con asa / with handle / avec anse / mit Griff	980	1

P8058 / P8059 Carro inox para cestas / St/steel trolley for dishwasher racks /
Chariot inox pour casiers à vaisselle / Edelstahlwagen für Spülkörbe

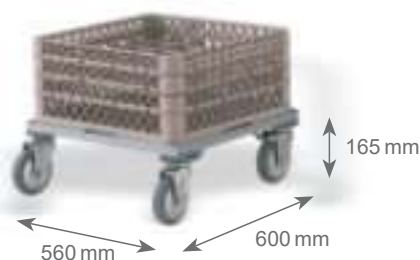

REF			
P80.590	sin asa / without handle / sans anse / ohne Griff		1
P80.580	con asa / with handle / avec anse / mit Griff		1

P8075 / P8076 / P8077 Carro para cestas Vajillas / Dishwasher rack trolley /
Chariot casiers à vaisselle / Wagen für Spülkörbe



REF	Medida guías / Size of rails / Dimensions glissières / Einschubgrößen mm	Nº Guías / Nr. of Levels / Num.Niveaux / Nr. Einschübe	A x B x C mm	
P80.750	500 x 500	5	640 x 633 x 1160	1
P80.760	500 x 500	9	640 x 633 x 1710	1
P80.770	500 x 500 (doble / double)	9	1185 x 633 x 1710	1

ADC-4 Carro ajustable para platos / *Adjustable dish caddy /*
Chariot modulable pour assiettes / *Einstellbarer Tellerwagen*



REF	
ADC-4	1

Se sirve con 4 columnas separadoras más una funda protectora.
Delivered with 4 posts plus 1 protection cover.
Livré avec 4 colonnes de séparation et 1 housse de protection.
Lieferung mit 4 Unterteilungssäulen und einer Schutzhülle.

Ajuste único y fácil por la parte superior.
Unique and easy adjustment from the top.
Reglage unique et facile de la partie supérieure.
Einzigartige und einfache Einstellung des Oberteils.

COMBINACIONES /
COMBINATIONS /
COMBINATIONS /
COMBINATIONS /
KOMBINATIONEN

Tamaño platos
Size plates
Taille assiettes
Tellergröße

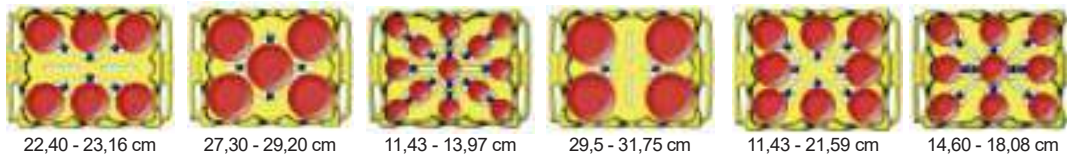

SAC-SQ5-06 Carro ajustable para platos cuadrados y redondos / *Adjustable caddy for square & round dishes /*
Chariot modulable pour assiettes carrées et rondes / *Einstellbarer Wagen für runde und quadratische Teller*



REF	
SAC-SQ5-06	1

Se sirve con 5 columnas separadoras una de ellas en forma de cruz más una funda protectora.
Delivered with 5 posts, one of them in cross shape plus 1 protection cover.
Livré avec 5 colonnes de séparation une desquelles en forme de croix plus 1 housse de protection.
Lieferung mit 5 Unterteilungssäulen, eine von Ihnen in Kreuzform und einer Schutzhülle.



Diseño exclusivo apilable.
Unique, stackable design.
Design exclusif empilable.
Exclusives Design stapelbar.



ADP Columna separadora carro platos / Post for dish trolley /
Colonne séparation chariot assiettes / Unterteilungssäule für Tellerwagen



REF	
ADP	1

Compatible ref: ADC-4 y SAC-SQ5-06.
Compatible ref: ADC-4 & SAC-SQ5-06.
Compatible réf: ADC-4 et SAC-SQ5-06.
Passend für Art.Nr.: ADC-4 und SAC-SQ5-06.

SAVC / ADVC Funda protectora de vinilo para carro platos / Vinyl cover for dish trolley /
Housse protection en vynil pour chariot assiettes / Vynilschutzhülle für Tellerwagen



REF	
SAVC	1

SAVC. Funda para ref. / ADVC. Funda para ref. /
Cover for item / Cover for item /
Housse pour réf. / Housse pour réf. /
Hülle für Art.Nr. / Hülle für Art.Nr.
ADC-4 SAC-SQ5-06

ICE140-06 Carro hielo / Ice caddy / Chariot à glaçons / Eiswagen



REF	KG	cm	Hcm	
ICE140-06	63,5	91,5 x 70	77,5	1



Con grifo desagüe para facilitar el vaciado del carro.
With drainage tap to facilitate emptying the trolley.
Avec robinet de vidange pour faciliter la vidange du chariot.
Mit Ablasshahn zum Entleeren des Wagens.



Dos ruedas con frenos para evitar movimientos no previstos.
Two wheels with brakes to prevent accidental movement.
Deux roues avec freins pour éviter des mouvements incontrôlés.
Zwei Räder mit Bremsvorrichtungen, um unvorhergesehene Bewegungen zu vermeiden.



Ideal para ser utilizado en banquetes y eventos en el exterior.
Ideal for use at banquets and external events.
Idéal pour banquets et événements extérieurs.
Ideal für den Gebrauch bei Banketten und Veranstaltungen im Freien.



ESTANTERÍAS /
SHELVING /
ÉTAGÈRES /
REGALE

11.1	ESTANTERÍAS COMPLETAS Y ANGULARES / <i>COMPLETE AND ANGULAR SHELVING /</i> ÉTAGÈRE PLEINE ET ANGULAIRES / <i>KOMPLETTE ECKIGE REGALE</i>	267
11.2	ESTANTERÍAS CON RUEDAS / <i>SHELVING ON CASTORS /</i> ÉTAGÈRES AVEC ROUES / <i>REGALE MIT ROLLEN</i>	274
11.3	BANCADAS / BENCH / <i>BANCS / BÄNKE</i>	274
11.4	COMPONENTES / PARTS / <i>COMPONENTS / KOMPONENTEN</i>	275

ESTANTERÍAS MODULARES / MODULAR SHELVING / ÉTAGÈRESMODULABLES / KOMBINIERBARE REGALMODULE

-30 °C
+75 °C

FACILIDAD Y RAPIDEZ DE MONTAJE /
EASY AND QUICK ASSEMBLY /
FACILE ET RAPIDE MONTAGE /
EINFACHE UND SCHNELLE MONTAGE



ALUMINIO Y POLIPROPILENO /
ALUMINIUM AND POLYPROPYLENE /
ALUMINIUM ET POLYPROPYLÈNE/
ALUMINIUM UND POLYPROPYLEN

ANTICORROSIÓN - Fabricadas con estructura de aluminio anodizado /

ANTICORROSIVE - Manufactured with special anodised aluminium /

ANTI-CORROSION-Fabriquéés avec une structure en aluminium anodisé /

ANTI-KORRUSION - Regale aus Spezial eloxiertem Aluminium hergestellt

**ROBUSTEZ Y RESISTENCIA / ROBUSTNESS AND RESISTANCE /
ROBUSTESSE ET RESISTANCE / ROBUST UND RESISTENT**



**COMPATIBLE / COMPATIBILITY / COMPATIBILITÉ/PASSEND
GN 1/1 & 2/3**

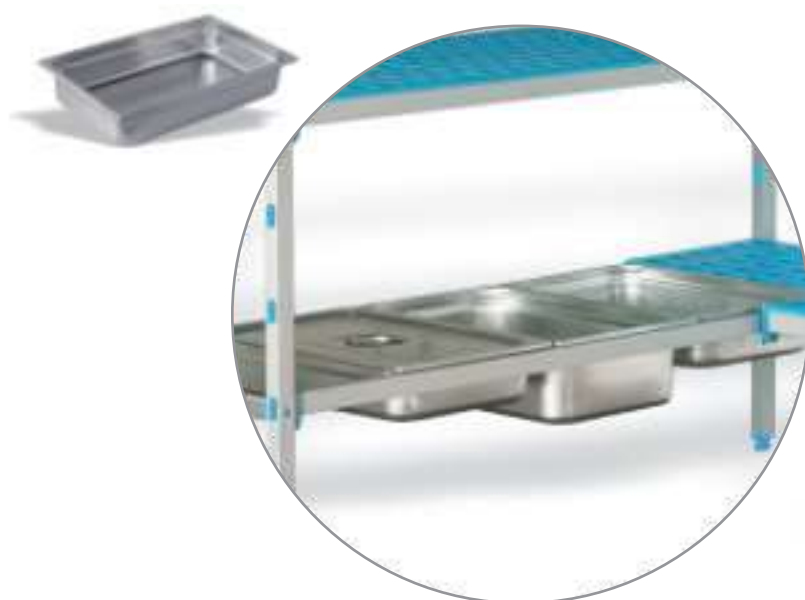

Parrillas / Rack shelves / Clayettes / Gitterböden

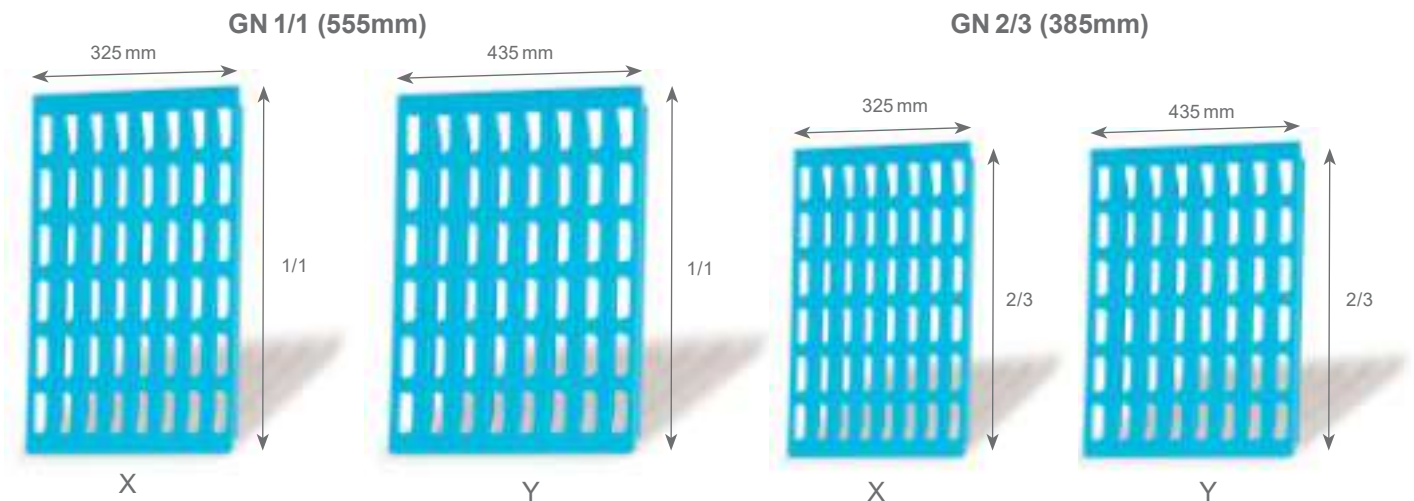

Apto para lavavajillas
Dishwasher safe
Apte pour lave-vaisselle
Geeignet für Spülmaschinen

Combinando parrillas de la misma profundidad (X/Y) permite personalizar las longitudes de las estanterías a cada una de las necesidades. (Ver en página siguiente combinaciones propuestas)

*Combining rack shelves among the same group (X/Y) allows to personalize the lengths of each shelf.
(Refer to next page for proposed combinations)*

*En combinant des clayettes du même groupe (X/Y) permet de personnaliser les longueurs des étagères à n'importe quel besoin.
(Voir page suivante pour des combinaisons proposées)*

*Die Kombination der Gitterböden gleicher Tiefe (X/Y) erlaubt die Länge der Regale individuell je nach Bedarf zu bestimmen.
(Siehe Kombinerungsvorschläge folgende Seite)*

Pieza soporte travesaños / Support for grossbars / Crochet support pour largerons / Halterungsteil Traversen

Sistema especial de fijación de soporte para travesaños que ofrece la máxima seguridad, fiabilidad y robustez.

Special fixing system support for crossbars which offers the highest security, reliability and robustness.

Système spécial de fixation des supports pour longerons qui offre la sécurité, fiabilité et robustesse maximale.

Spezielles System der Halterverankerung für die Traversen, welches die höchste Sicherheit, Zuverlässigkeit und Robustheit bietet.



Pies regulables / Leveling feet / Pieds régulateurs / Regulierbare Füße

Pies regulables con rosca oculta para suelos con desniveles. Con la posibilidad de adaptar ruedas de Ø 125 mm.

Levelling feet with hidden thread, for gradient floors. It is also possible to adapt Ø 125 mm wheels.

Pieds régulateurs avec filet cache. Il est aussi possible d'y adapter des roues de Ø 125 mm.

Regulierbare Füße mit verborgenem Gewinde für unebene Böden. Mit der Möglichkeit Räder Ø 125 mm anzubringen.

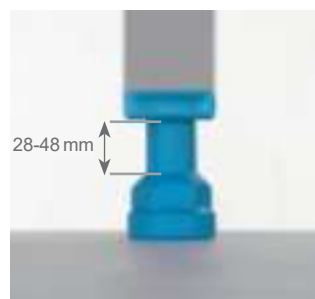

Alturas estándar de los niveles / Standard heights of levels / Hauteur standard des niveaux / Standardhöhe der Ebenen

Altura 1280 mm / 3 niveles
Height 1280 mm / 3 levels
Hauteur 1280 mm / 3 niveaux
Höhe 1280 mm / 3 Ebenen

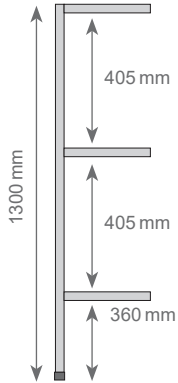

Más de 2000 mm altura consultar /
Higher than 2000 mm please ask /
Hauteur supérieure à 2000 mm veuillez nous consulter /
Höher als 2000 mm bitte fragen Sie uns

Combinaciones /
Combinations /
Combinaisons /
Kombinationen

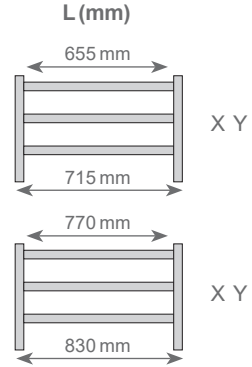

Altura 1750 mm / 3 niveles
Height 1750 mm / 3 levels
Hauteur 1750 mm / 3 niveaux
Höhe 1750 mm / 3 Ebenen

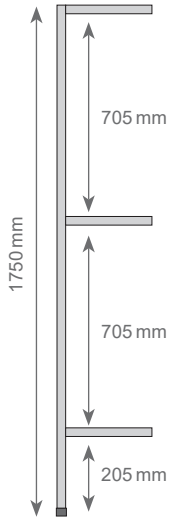

Altura 1750 mm / 4 niveles
Height 1750 mm / 4 levels
Hauteur 1750 mm / 4 niveaux
Höhe 1750 mm / 4 Ebenen

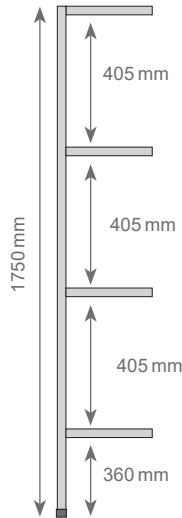

Altura 1750 mm / 5 niveles
Height 1750 mm / 5 levels
Hauteur 1750 mm / 5 niveaux
Höhe 1750 mm / 5 Ebenen

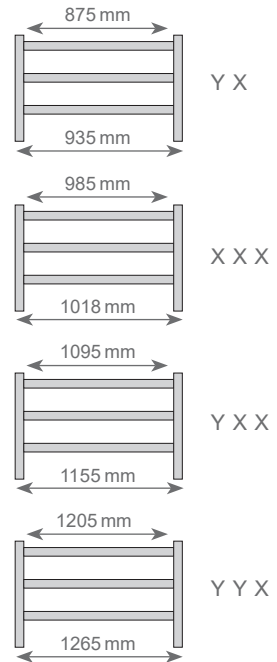
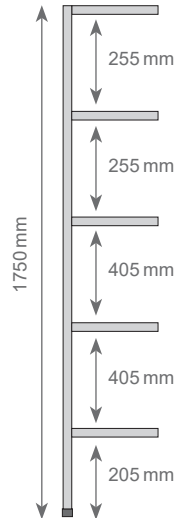

Altura 2050 mm / 4 niveles
Height 2050 mm / 4 levels
Hauteur 2050 mm / 4 niveaux
Höhe 2050 mm / 4 Ebenen

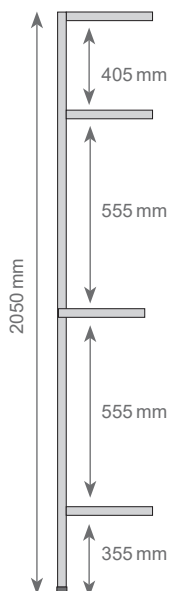

Altura 2050 mm / 5 niveles
Height 2050 mm / 5 levels
Hauteur 2050 mm / 5 niveaux
Höhe 2050 mm / 5 Ebenen

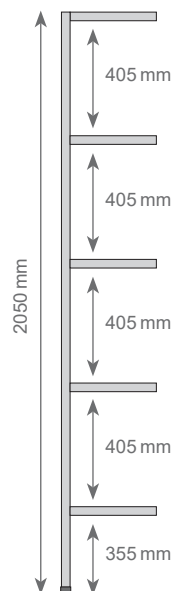

Altura 2050 mm / 6 niveles
Height 2050 mm / 6 levels
Hauteur 2050 mm / 6 niveaux
Höhe 2050 mm / 6 Ebenen

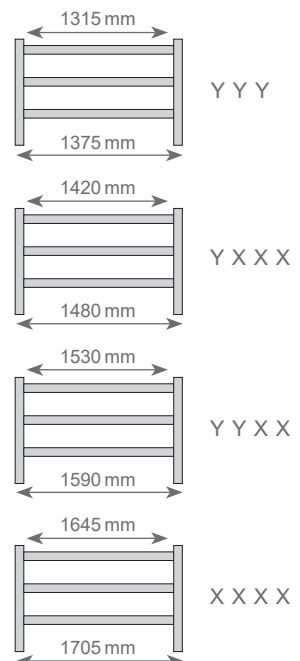
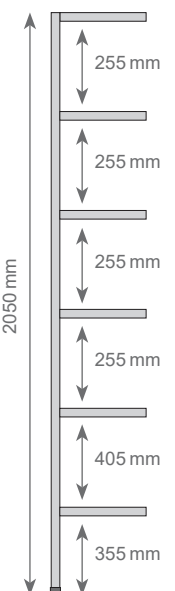

ESTANTERIAS COMPLETAS Y ANGULARES /

*COMPLETE AND ANGULAR
SHELVING /*

*ÉTAGÈRES COMPLÈTES
ET D'ANGLE /*

*KOMPLETTE
ECKIGE REGALE*



ESTANTERIAS /
SHELVING /
ÉTAGÈRES

3 NIVELES /
LEVELS /
NIVEAUX /
EBENEN

Kits completos / Complete kits / Kits préparés / Komplettssets

Distintas combinaciones /
Diferent combinations /
Diferentes combinaisons /
Verschiedene Kombinationen

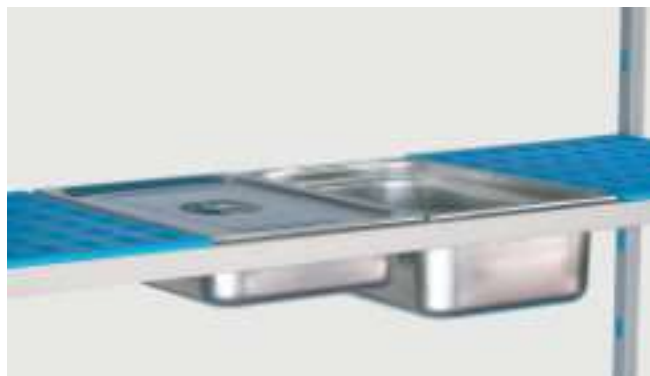

Compatible con cubetas 2/3 /
Compatible with 2/3 containers /
Compatible avec bacs 2/3 /
Kombinierbar mit Behältern 2/3

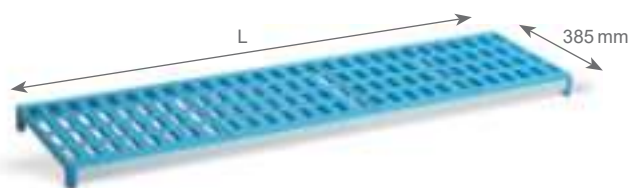

Compatible con cubetas 1/1 /
Compatible with 1/1 containers /
Compatible avec bacs 1/1 /
Kombinierbar mit Behältern 1/1

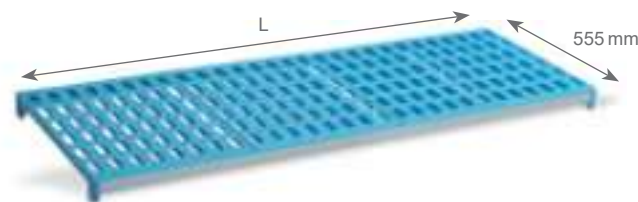

REF	L mm	REF	L mm
P7000	715	P7024	3380
P7001	830	P7025	3513
P7002	935	P7026	3621
P7003	1045	P7027	3729
P7004	1155	P7028	3841
P7005	1265	P7029	3953
P7006	1375	P7030	4065
P7007	1480	P7031	4170
P7008	1590	P7032	4275
P7009	1705	P7033	4380
P7010	1840	P7034	4490
P7011	1950	P7035	4600
P7012	2060	P7036	4710
P7013	2170	P7037	4825
P7014	2280	P7038	4940
P7015	2388	P7039	5055
P7016	2496	P7040	5186
P7017	2608	P7041	5298
P7018	2720	P7042	5410
P7019	2825	P7043	5515
P7020	2930	P7044	5620
P7021	3040	P7045	5725
P7022	3150	P7046	5830
P7023	3265		

REF	L mm	REF	L mm
P7141	715	P7165	3380
P7142	830	P7166	3513
P7143	935	P7167	3621
P7144	1045	P7168	3729
P7145	1155	P7169	3841
P7146	1263	P7170	3953
P7147	1375	P7171	4065
P7148	1480	P7172	4170
P7149	1590	P7173	4275
P7150	1705	P7174	4380
P7151	1840	P7175	4490
P7152	1950	P7176	4600
P7153	2060	P7177	4710
P7154	2170	P7178	4825
P7155	2280	P7179	4940
P7156	2388	P7180	5055
P7157	2496	P7181	5186
P7158	2608	P7182	5298
P7159	2720	P7183	5410
P7160	2825	P7184	5515
P7161	2930	P7185	5620
P7162	3040	P7186	5725
P7163	3150	P7187	5830
P7164	3265		



* Para otras alturas, consultar el Desglose (p. 278 - 281) / * For others heights, see the Table (p. 278 - 281) /
* Pour autres hauteurs, consulter l'Index numérique (p 278 - 281) / * Für weitere Größen, siehe Gliederung (S. 278 - 281)

3 NIVELES / LEVELS / NIVEAUX / EBENEN

Estanterías angulares / Shelvings for angle / Étagères angulaires / Rechtwinklige Regale

Distintas combinaciones /
Diferent combinations /
Diferentes combinaisons /
Verschiedene Kombinationen

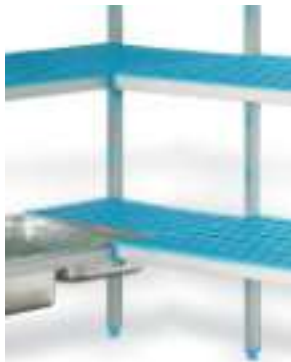

Incluido / Included / Compris / Inklusive:
Ganchos para formar ángulos /
Hooks to form angles /
Crochets pour faire les angles /
Haken für Winkelbildung

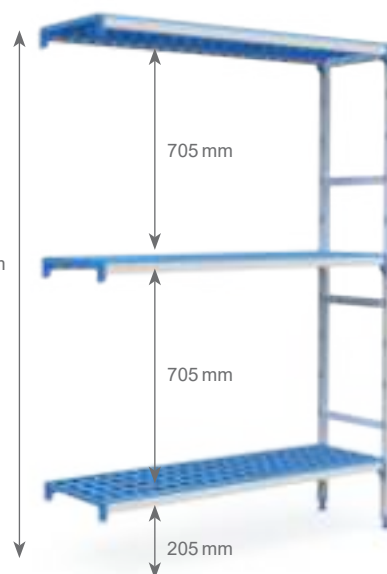

Compatible con cubetas 2/3 /
Compatible with 2/3 containers /
Compatible avec bacs 2/3 /
Kombinierbar mit Behältern 2/3

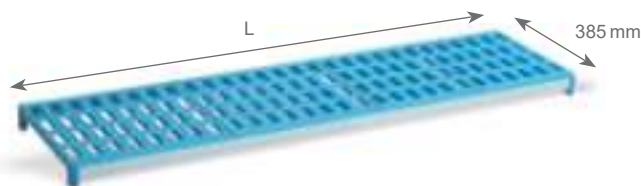

REF	L mm	REF	L mm
P7282	685	P7306	3350
P7283	800	P7307	3483
P7284	905	P7308	3591
P7285	1015	P7309	3699
P7286	1125	P7310	3811
P7287	1233	P7311	3923
P7288	1345	P7312	4035
P7289	1450	P7313	4140
P7290	1560	P7314	4245
P7291	1675	P7315	4350
P7292	1810	P7316	4460
P7293	1920	P7317	4570
P7294	2030	P7318	4680
P7295	2140	P7319	4795
P7296	2250	P7320	4910
P7297	2358	P7321	5025
P7298	2466	P7322	5156
P7299	2578	P7323	5268
P7300	2690	P7324	5380
P7301	2795	P7325	5485
P7302	2900	P7326	5590
P7303	3010	P7327	5695
P7304	3120	P7328	5800
P7305	3235		

Compatible con cubetas 1/1 /
Compatible with 1/1 containers /
Compatible avec bacs 1/1 /
Kombinierbar mit Behältern 1/1

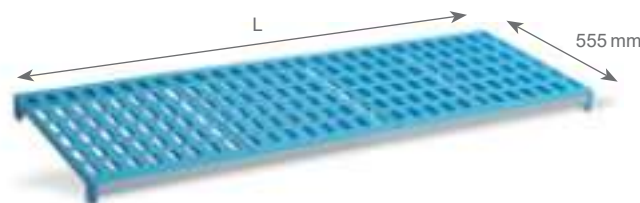

REF	L mm	REF	L mm
P7423	685	P7447	3350
P7424	800	P7448	3483
P7425	905	P7449	3591
P7426	1015	P7450	3699
P7427	1125	P7451	3811
P7428	1233	P7452	3923
P7429	1345	P7453	4035
P7430	1450	P7454	4140
P7431	1560	P7455	4245
P7432	1675	P7456	4350
P7433	1810	P7457	4460
P7434	1920	P7458	4570
P7435	2030	P7459	4680
P7436	2140	P7460	4795
P7437	2250	P7461	4910
P7438	2358	P7462	5025
P7439	2466	P7463	5156
P7440	2578	P7464	5268
P7441	2690	P7465	5380
P7442	2795	P7466	5485
P7443	2900	P7467	5590
P7444	3010	P7468	5695
P7445	3120	P7469	5800
P7446	3235		



* Para otras alturas, consultar el Desglose (p. 278 - 281) / * For others heights, see the Table (p. 278 - 281) /
* Pour autres hauteurs, consulter l'Index numérique (p 278 - 281) / * Für weitere Größen, siehe Gliederung (S. 278 - 281)

4 NIVELES /
LEVELS /
NIVEAUX /
EBENEN

Kits completos / Complete kits / Kits préparés / Komplettssets

Distintas combinaciones /
Diferent combinations /
Diferentes combinaisons /
Verschiedene Kombinationen

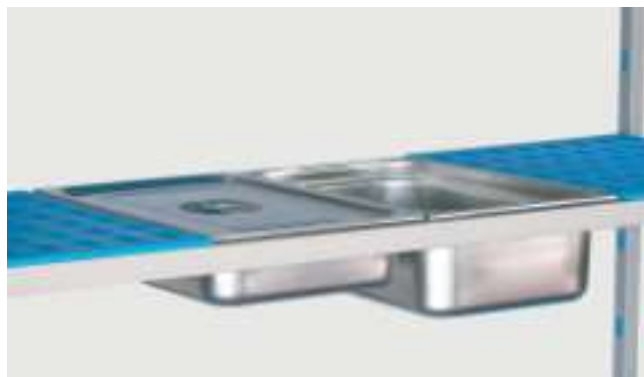

Compatible con cubetas 2/3 /
Compatible with 2/3 containers /
Compatible avec bacs 2/3 /
Kombinierbar mit Behältern 2/3

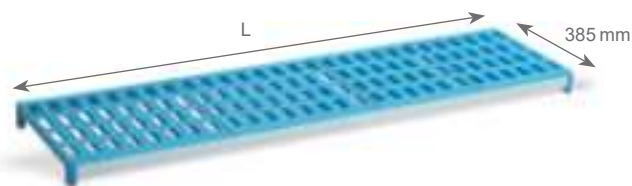

REF	L mm	REF	L mm
P7047	715	P7071	3380
P7048	830	P7072	3513
P7049	935	P7073	3621
P7050	1045	P7074	3729
P7051	1155	P7075	3841
P7052	1263	P7076	3953
P7053	1375	P7077	4065
P7054	1480	P7078	4170
P7055	1590	P7079	4275
P7056	1705	P7080	4380
P7057	1840	P7081	4490
P7058	1950	P7082	4600
P7059	2060	P7083	4710
P7060	2170	P7084	4825
P7061	2280	P7085	4940
P7062	2388	P7086	5055
P7063	2496	P7087	5186
P7064	2608	P7088	5298
P7065	2720	P7089	5410
P7066	2825	P7090	5515
P7067	2930	P7091	5620
P7068	3040	P7092	5725
P7069	3150	P7093	5830
P7070	3265		

Compatible con cubetas 1/1 /
Compatible with 1/1 containers /
Compatible avec bacs 1/1 /
Kombinierbar mit Behältern 1/1

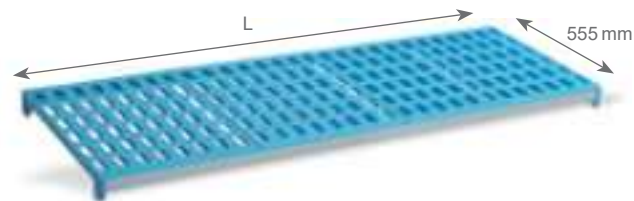

REF	L mm	REF	L mm
P7188	715	P7212	3380
P7189	830	P7213	3513
P7190	935	P7214	3621
P7191	1045	P7215	3729
P7192	1155	P7216	3841
P7193	1263	P7217	3953
P7194	1375	P7218	4065
P7195	1480	P7219	4170
P7196	1590	P7220	4275
P7197	1705	P7221	4380
P7198	1840	P7222	4490
P7199	1950	P7223	4600
P7200	2060	P7224	4710
P7201	2170	P7225	4825
P7202	2280	P7226	4940
P7203	2388	P7227	5055
P7204	2496	P7228	5186
P7205	2608	P7229	5298
P7206	2720	P7230	5410
P7207	2825	P7231	5515
P7208	2930	P7232	5620
P7209	3040	P7233	5725
P7210	3150	P7234	5830
P7211	3265		



* Para otras alturas, consultar el Desglose (p. 278 - 281) / * For others heights, see the Table (p. 278 - 281) /
* Pour autres hauteurs, consulter l'Index numérique (p 278 - 281) / * Für weitere Größen, siehe Gliederung (S. 278 - 281)

4 NIVELES /
LEVELS /
NIVEAUX /
EBENEN

Estanterías angulares / Shelvings for angle / Étagères angulaires / Rechtwinklige Regale

Distintas combinaciones /
Diferent combinations /
Diferentes combinaisons /
Verschiedene Kombinationen

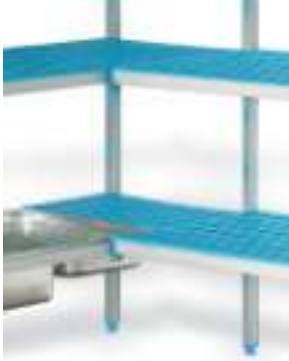

Incluido / Included / Compris / Inklusive:
Ganchos para formar ángulos /
Hooks to form angles /
Crochets pour faire les angles /
Haken für Winkelbildung



Compatible con cubetas 2/3 /
Compatible with 2/3 containers /
Compatible avec bacs 2/3 /
Kombinierbar mit Behältern 2/3

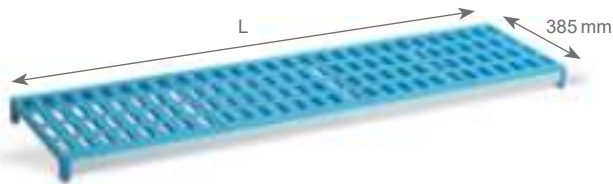

Compatible con cubetas 1/1 /
Compatible with 1/1 containers /
Compatible avec bacs 1/1 /
Kombinierbar mit Behältern 1/1

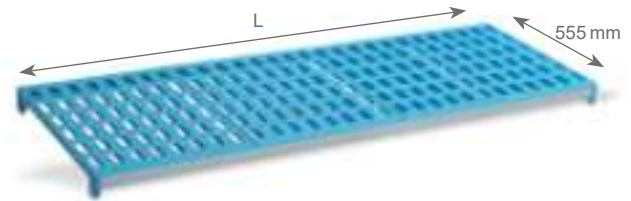

REF	L mm
P7329	685
P7330	800
P7331	905
P7332	1015
P7333	1125
P7334	1233
P7335	1345
P7336	1450
P7337	1560
P7338	1675
P7339	1810
P7340	1920
P7341	2030
P7342	2140
P7343	2250
P7344	2358
P7345	2466
P7346	2578
P7347	2690
P7348	2795
P7349	2900
P7350	3010
P7351	3120
P7352	3235

REF	L mm
P7353	3350
P7354	3483
P7355	3591
P7356	3699
P7357	3811
P7358	3923
P7359	4035
P7360	4140
P7361	4245
P7362	4350
P7363	4460
P7364	4570
P7365	4680
P7366	4795
P7367	4910
P7368	5025
P7369	5156
P7370	5268
P7371	5380
P7372	5485
P7373	5590
P7374	5695
P7375	5800

REF	L mm
P7470	685
P7471	800
P7472	905
P7473	1015
P7474	1125
P7475	1233
P7476	1345
P7477	1450
P7478	1560
P7479	1675
P7480	1810
P7481	1920
P7482	2030
P7483	2140
P7484	2250
P7485	2358
P7486	2466
P7487	2578
P7488	2690
P7489	2795
P7490	2900
P7491	3010
P7492	3120
P7493	3235

REF	L mm
P7494	3350
P7495	3483
P7496	3591
P7497	3699
P7498	3811
P7499	3923
P7500	4035
P7501	4140
P7502	4245
P7503	4350
P7504	4460
P7505	4570
P7506	4680
P7507	4795
P7508	4910
P7509	5025
P7510	5156
P7511	5268
P7512	5380
P7513	5485
P7514	5590
P7515	5695
P7516	5800



* Para otras alturas, consultar el Desglose (p. 278 - 281) / * For others heights, see the Table (p. 278 - 281) /
* Pour autres hauteurs, consulter l'Index numérique (p 278 - 281) / * Für weitere Größen, siehe Gliederung (S. 278 - 281)

5 NIVELES /
LEVELS /
NIVEAUX /
EBENEN

Kits completos / Complete kits / Kits préparés / Komplettssets

Distintas combinaciones /
Diferent combinations /
Diferentes combinaisons /
Verschiedene Kombinationen

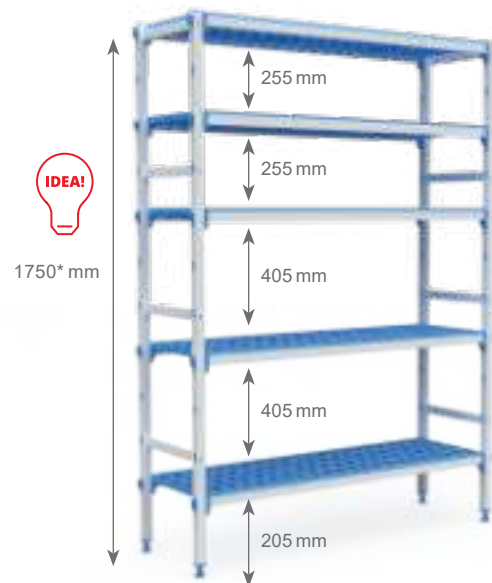
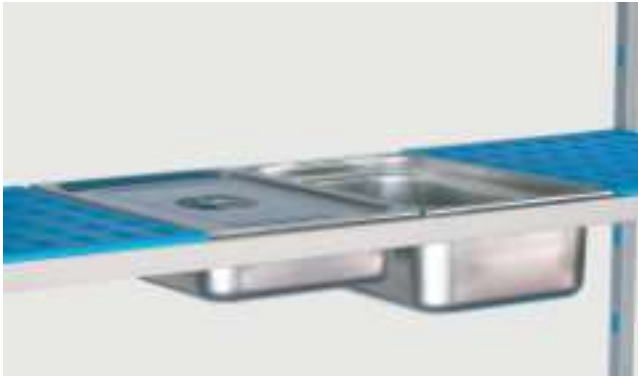

Compatible con cubetas 2/3 /
Compatible with 2/3 containers /
Compatible avec bacs 2/3 /
Kombinierbar mit Behältern 2/3



Compatible con cubetas 1/1 /
Compatible with 1/1 containers /
Compatible avec bacs 1/1 /
Kombinierbar mit Behältern 1/1

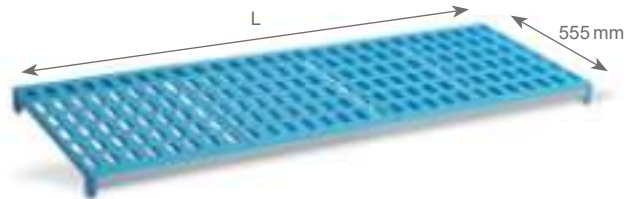

REF	L mm
P7094	715
P7095	830
P7096	935
P7097	1045
P7098	1155
P7099	1263
P7100	1375
P7101	1480
P7102	1590
P7103	1705
P7104	1840
P7105	1950
P7106	2060
P7107	2170
P7108	2280
P7109	2388
P7110	2496
P7111	2608
P7112	2720
P7113	2825
P7114	2930
P7115	3040
P7116	3150
P7117	3265

REF	L mm
P7118	3380
P7119	3513
P7120	3621
P7121	3729
P7122	3841
P7123	3953
P7124	4065
P7125	4170
P7126	4275
P7127	4380
P7128	4490
P7129	4600
P7130	4710
P7131	4825
P7132	4940
P7133	5055
P7134	5186
P7135	5298
P7136	5410
P7137	5515
P7138	5620
P7139	5725
P7140	5830

REF	L mm
P7235	715
P7236	830
P7237	935
P7238	1045
P7239	1155
P7240	1263
P7241	1375
P7242	1480
P7243	1590
P7244	1705
P7245	1840
P7246	1950
P7247	2060
P7248	2170
P7249	2280
P7250	2388
P7251	2496
P7252	2608
P7253	2720
P7254	2825
P7255	2930
P7256	3040
P7257	3150
P7258	3265

REF	L mm
P7259	3380
P7260	3513
P7261	3621
P7262	3729
P7263	3841
P7264	3953
P7265	4065
P7266	4170
P7267	4275
P7268	4380
P7269	4490
P7270	4600
P7271	4710
P7272	4825
P7273	4940
P7274	5055
P7275	5186
P7276	5298
P7277	5410
P7278	5515
P7279	5620
P7280	5725
P7281	5830



* Para otras alturas, consultar el Desglose (p. 278 - 281) / * For others heights, see the Table (p. 278 - 281) /
* Pour autres hauteurs, consulter l'Index numérique (p 278 - 281) / * Für weitere Größen, siehe Gliederung (S. 278 - 281)

5 NIVELES / LEVELS / NIVEAUX / EBENEN

Estanterías angulares / Shelvings for angle / Étagères angulaires / Rechtwinklige Regale

Distintas combinaciones /
Diferent combinations /
Diferentes combinaisons /
Verschiedene Kombinationen

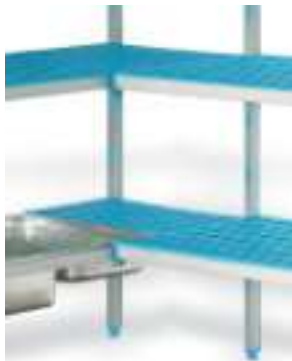

Incluido / Included / Compris / Inklusive:
Ganchos para formar ángulos /
Hooks to form angles /
Crochets pour faire les angles /
Haken für Winkelbildung



1750* mm

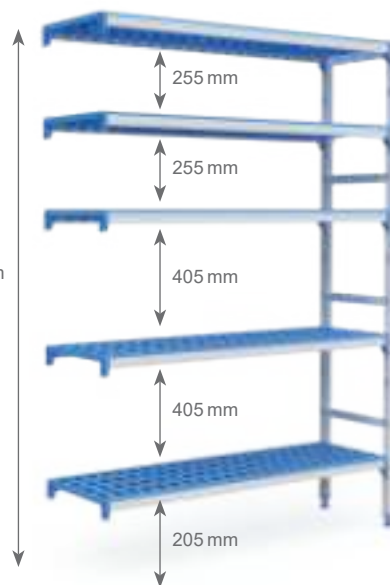

Compatible con cubetas 2/3 /
Compatible with 2/3 containers /
Compatible avec bacs 2/3 /
Kombinierbar mit Behältern 2/3

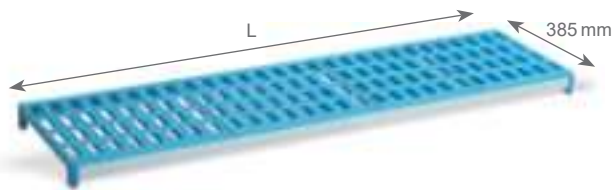

Compatible con cubetas 1/1 /
Compatible with 1/1 containers /
Compatible avec bacs 1/1 /
Kombinierbar mit Behältern 1/1

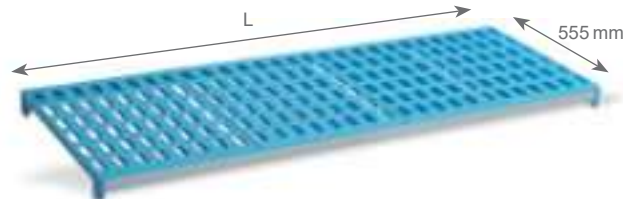

REF	L mm
P7376	685
P7377	800
P7378	905
P7379	1015
P7380	1125
P7381	1233
P7382	1345
P7383	1450
P7384	1560
P7385	1675
P7386	1810
P7387	1920
P7388	2030
P7389	2140
P7390	2250
P7391	2358
P7392	2466
P7393	2578
P7394	2690
P7395	2795
P7396	2900
P7397	3010
P7398	3120
P7399	3235

REF	L mm
P7400	3350
P7401	3483
P7402	3591
P7403	3699
P7404	3811
P7405	3923
P7406	4035
P7407	4140
P7408	4245
P7409	4350
P7410	4460
P7411	4570
P7412	4680
P7413	4795
P7414	4910
P7415	5025
P7416	5156
P7417	5268
P7418	5380
P7419	5485
P7420	5590
P7421	5695
P7422	5800

REF	L mm
P7517	685
P7518	800
P7519	905
P7520	1015
P7521	1125
P7522	1233
P7523	1345
P7524	1450
P7525	1560
P7526	1675
P7527	1810
P7528	1920
P7529	2030
P7530	2140
P7531	2250
P7532	2358
P7533	2466
P7534	2578
P7535	2690
P7536	2795
P7537	2900
P7538	3010
P7539	3120
P7540	3235

REF	L mm
P7541	3350
P7542	3483
P7543	3591
P7544	3699
P7545	3811
P7546	3923
P7547	4035
P7548	4140
P7549	4245
P7550	4350
P7551	4460
P7552	4570
P7553	4680
P7554	4795
P7555	4910
P7556	5025
P7557	5156
P7558	5268
P7559	5380
P7560	5485
P7561	5590
P7562	5695
P7563	5800



* Para otras alturas, consultar el Desglose (p. 278 - 281) / * For others heights, see the Table (p. 278 - 281) /
* Pour autres hauteurs, consulter l'Index numérique (p 278 - 281) / * Für weitere Größen, siehe Gliederung (S. 278 - 281)

Conjunto completo con ruedas / Complet kits with wheels / Kit préparés avec roues / Komplettes Set mit Rädern



REF	A mm	B mm	C mm	TIPO / TYPE	Niveles / Levels / Niveaux / Ebenen	
P7145R	1145	555	1880	GN 1/1	3	1
P7004R	1145	385	1880	GN 2/3	3	1
P7146R	1265	555	1880	GN 1/1	3	1
P7005R	1265	385	1880	GN 2/3	3	1
P7147R	1375	555	1880	GN 1/1	3	1
P7006R	1375	385	1880	GN 2/3	3	1



Peso máximo por nivel 150 kg
Peso máximo por estantería 400 kg /

Maximum weight per level 150 kg
Maximum weight per shelving unit 400 kg /

Poids maximum par niveau 150 kg
Poids maximum par étagère 400 kg

Maximales Gewicht pro Ebene 150 kg
Maximales Gewicht pro Regal 400 kg

Bancadas / Bench / Bancs / Bänke

Diseñadas para su uso en lugares donde se prohíbe depositar cajas directamente en el suelo. Capacidad de carga de hasta 175 Kg por bancada, repartidos a lo largo de la bancada. Pie regulable para suelos desnivelados.

Designed to be used in places where it is forbidden to put boxes directly on the floor. Maximum load charge 175 Kg per bench, distributed weight throughout the bench. Leveling feet for gradient floors.

Dessiné pour être utilisés quand il est interdit de poser les boîtes directement par terre. Charge maximale 175 Kg, distribués tout au long du banc. Pieds régulateurs pour sols inégaux.

Design für den Gebrauch in Räumen, in denen es verboten ist Kisten direkt auf den Boden zu stellen. Die Tragkraft beträgt bis zu 175 Kg pro Bank, wenn die Last gleichmässig auf der Länge verteilt ist. Regulierbare Füße für unebene Böden.

REF	A mm	B mm	C mm	
P7603	715	555	280	1
P7604	830	555	280	1
P7605	935	555	280	1
P7606	1045	555	280	1
P7607	1155	555	280	1
P7608	1265	555	280	1
P7609	1375	555	280	1
P7610	1480	555	280	1
P7611	715	385	280	1
P7612	830	385	280	1
P7613	935	385	280	1
P7614	1045	385	280	1
P7615	1155	385	280	1
P7616	1260	385	280	1
P7617	1375	385	280	1
P7618	1480	385	280	1

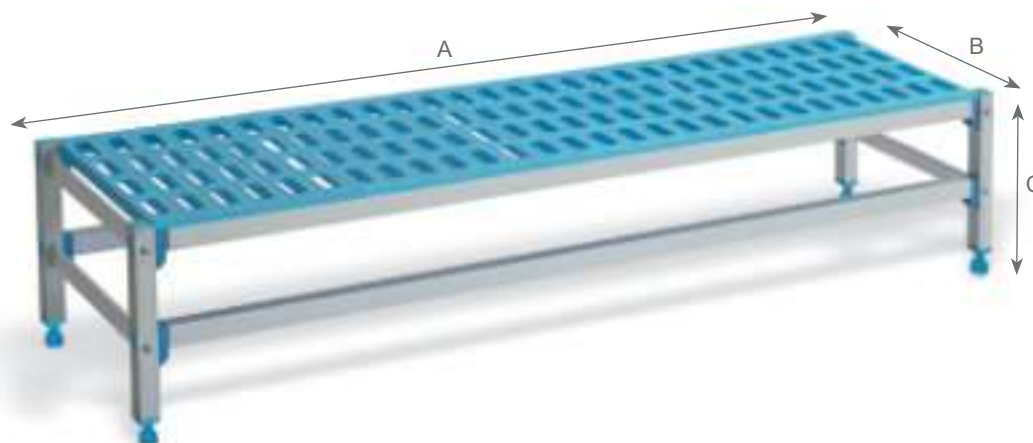

Soprote fijación estantería / Shelf support fixing / Support fixation étagère / Regal Fixierhalterung



REF	
P76.430	1

Conjunto de 2 soportes /
Two pieces kit /
Kit deux pièces /
Kit mit 2 Stück





Travesaños / Crossbars / Longérons / Traversen

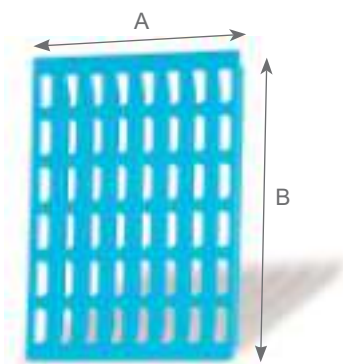

REF	L mm	
P7632	655	1
P7633	770	1
P7634	875	1
P7635	985	1
P7636	1095	1
P7637	1205	1
P7638	1315	1
P7639	1420	1
P7640	1530	1
P7641	1645	1

Parrillas / Rack-shelves / Clayettes / Einlegeböden



REF	TIPO / TYPE	A mm	B mm	GN Para / For / Pour / Für	
P7628	Y	435	555	1/1	1
P7629	X	325	555	1/1	1
P7630	Y	435	385	2/3	1
P7631	X	325	385	2/3	1

Ganchos para formar ángulos / Hooks to form angles / Crochets pour faire les angles / Haken für Winkelbildung



REF	
P7642	1

Pieza soporte para travesaños / Support for crossbars / Support pour largerons / Halterteil für Traversen



REF	
P7643	1

Soportes laterales / Lateral supports / Support latéraux / Seitliche Ständer

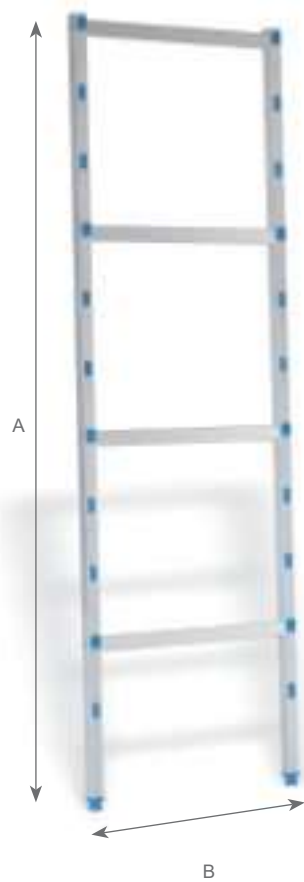

REF	MOD	A mm	B mm	Niveles / Levels / Niveaux / Ebenen	
P7585	S1	1750	555	3	1
P7586	S2	1750	555	4	1
P7587	S3	1750	555	5	1
P7646	S0	2000	555	4	1
P7588	S4	2000	555	5	1
P7589	S5	2000	555	6	1
P7590	S6	1300	555	3	1
P7591	S7	1750	385	3	1
P7592	S8	1750	385	4	1
P7593	S9	1750	385	5	1
P7647	S13	2000	385	4	1
P7594	S10	2000	385	5	1
P7595	S11	2000	385	6	1
P7596	S12	1300	385	3	1

2 Fondos disponibles :
555 mm, gastronorm 1/1
385 mm, gastronorm 2/3

2 Available depths:
555 mm, 1/1 gastronorm
385 mm, 2/3 gastronorm

2 profondeurs disponibles:
555 mm, gastronorme 1/1
385 mm, gastronorme 2/3

2 Tiefen erhältlich:
555 mm, Gastronorm 1/1
385 mm, Gastronorm 2/3

Soportes laterales con ruedas / Lateral support with wheels / Supports latéraux avec roues / Seitliche Ständer mit Räder

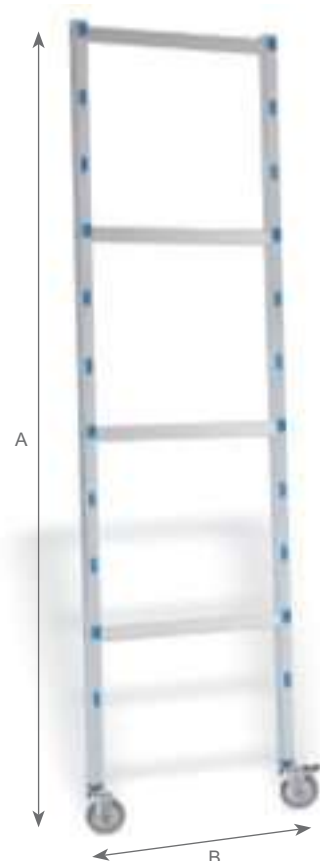

REF	A mm*	B mm	Niveles / Levels / Niveaux / Ebenen	
P7597	1.880	555	3	1
P7598	1.880	555	4	1
P7599	1.880	555	5	1

Para montar estanterías móviles con ruedas.
To assembly mobile shelving with wheels.
Pour monter étagères mobiles avec roues.
Für die Montage von mobilen Regalen mit Räder.

* Altura con rueda incluida
* Height including wheel
* Hauteur avec la roue
* Höhe inklusive Räder

Ruedas de Ø 125 mm, dos de ellas con freno.
Wheels Ø 125 mm, two of them with brake.
Roues de Ø 125 mm, deux avec frein.
Räder Ø 125 mm, zwei von ihnen mit Bremsen.

No se recomiendan longitudes de travesaños superiores a 1400 mm.
We do not advise crossbars longer than 1400 mm.
Nous ne recommandons pas des longerons plus longues de 1400 mm.
Wir empfehlen nicht die Länge der Traversen von 1400 mm zu überschreiten.

Fondo 385 mm. Adaptable a las cubetas gastronorm 2/3
Depth 385 mm. Suitable for 2/3 gastronorm containers
Profondeur 385 mm. Adaptable aux bacs gastronorme 2/3
Tiefe 385 mm. Passend für Gastronormbehälter 2/3

X significa una parrilla de ancho 325 mm.
Y significa una parrilla de ancho 435 mm.

X is a rack 325 mm width.
Y is a rack 435 mm width.

Xest une clayette de 325 mm de largeur.
Yest une clayette de 435 mm de largeur.

X Bezeichnet einen Einlegeboden der Breite von 325 mm.
Y Bezeichnet einen Gitterboden der Breite von 435 mm.

REF	MOD	Combinación / Combinaison / Kombination	A mm	B mm	
P7575	T61	X+X	655	385	1
P7576	T71	X+Y	770	385	1
P7577	T81	Y+Y	875	385	1
P7578	T91	X+X+X	985	385	1
P7579	T101	Y+X+X	1095	385	1
P7580	T111	Y+Y+X	1205	385	1
P7581	T131	Y+Y+Y	1315	385	1
P7582	T141	Y+X+X+X	1420	385	1
P7583	T151	Y+Y+X+X	1530	385	1
P7584	T161	Y+Y+Y+X	1645	385	1

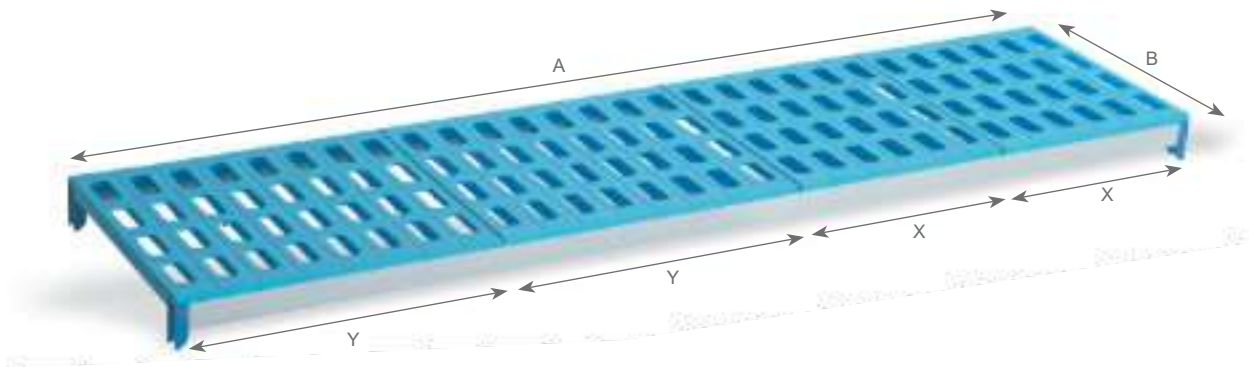

Fondo 555 mm. Adaptable a las cubetas gastronorm 1/1
Depth 555 mm. Suitable for 1/1 gastronorm containers
Profondeur 555 mm. Adaptable aux bacs gastronorme 1/1
Tiefe 555 mm. Passend für Gastronormbehälter 1/1

X significa una parrilla de ancho 325 mm.
Y significa una parrilla de ancho 435 mm.

X is a rack 325 mm width.
Y is a rack 435 mm width.

Xest une clayette de 325 mm de largeur.
Yest une clayette de 435 mm de largeur.

X Bezeichnet einen Einlegeboden der Breite von 325 mm.
Y Bezeichnet einen Gitterboden der Breite von 435 mm.

REF	MOD	Combinación / Combinaison / Kombination	A mm	B mm	
P7565	T6	X+X	655	555	1
P7566	T7	X+Y	770	555	1
P7567	T8	Y+Y	875	555	1
P7568	T9	X+X+X	985	555	1
P7569	T10	Y+X+X	1095	555	1
P7570	T11	Y+Y+X	1205	555	1
P7571	T13	Y+Y+Y	1315	555	1
P7572	T14	Y+X+X+X	1420	555	1
P7573	T15	Y+Y+X+X	1530	555	1
P7574	T16	Y+Y+Y+X	1645	555	1

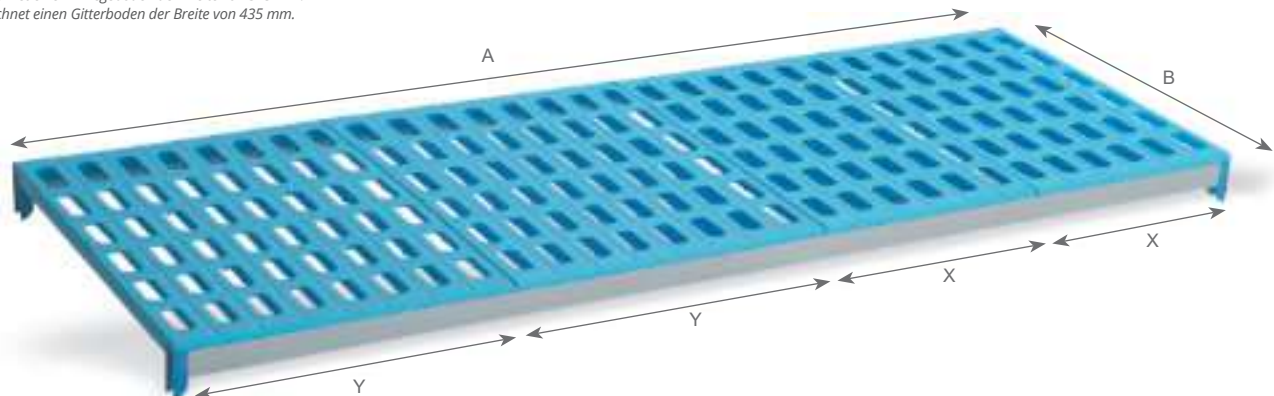

FONDO 385 MM. ADAPTABLE A GASTRONORM 2/3 / DEEPTH 385 MM. SUITABLE FOR 2/3 GASTRONORM /
PROFONDEUR385 MM. ADAPTABLEAUX GASTRONORME2/3 / TIEFE 385 MM. PASSEND FÜR GASTRONORM 2/3

REF. 3 niveles 3 levels 3 niveaux 3 Ebenen	DESGLOSE BREAKDOWN COMPOSITION AUFLISTUNG
P7000	2 S7 + 3 T61
P7001	2 S7 + 3 T71
P7002	2 S7 + 3 T81
P7003	2 S7 + 3 T91
P7004	2 S7 + 3 T101
P7005	2 S7 + 3 T111
P7006	2 S7 + 3 T131
P7007	2 S7 + 3 T141
P7008	2 S7 + 3 T151
P7009	2 S7 + 3 T161
P7010	3 S7 + 6 T81
P7011	3 S7 + 3 T81 + 3 T91
P7012	3 S7 + 6 T91
P7013	3 S7 + 3 T91 + 3 T101
P7014	3 S7 + 6 T101
P7015	3 S7 + 3 T101 + 3 T111
P7016	3 S7 + 6 T111
P7017	3 S7 + 3 T111 + 3 T131
P7018	3 S7 + 6 T131
P7019	3 S7 + 3 T131 + 3 T141
P7020	3 S7 + 6 T141
P7021	3 S7 + 3 T141 + 3 T151
P7022	3 S7 + 6 T151
P7023	3 S7 + 3 T151 + 3 T161
P7024	3 S7 + 6 T161
P7025	4 S7 + 6 T101 + 3 T111
P7026	4 S7 + 3 T101 + 6 T111
P7027	4 S7 + 9 T111
P7028	4 S7 + 6 T111 + 3 T131
P7029	4 S7 + 3 T111 + 6 T131
P7030	4 S7 + 9 T131
P7031	4 S7 + 6 T131 + 3 T141
P7032	4 S7 + 3 T131 + 6 T141
P7033	4 S7 + 9 T141
P7034	4 S7 + 6 T141 + 3 T151
P7035	4 S7 + 3 T141 + 6 T151
P7036	4 S7 + 9 T151
P7037	4 S7 + 6 T151 + 3 T161
P7038	4 S7 + 3 T151 + 6 T161
P7039	4 S7 + 9 T161
P7040	5 S7 + 6 T111 + 6 T131
P7041	5 S7 + 3 T111 + 9 T131
P7042	5 S7 + 12 T131
P7043	5 S7 + 3 T141 + 9 T131
P7044	5 S7 + 6 T131 + 6 T141
P7045	5 S7 + 3 T131 + 9 T141
P7046	5 S7 + 12 T141

REF. 4 niveles 4 levels 4 niveaux 4 Ebenen	DESGLOSE BREAKDOWN COMPOSITION AUFLISTUNG
P7047	2 S8 + 4 T61
P7048	2 S8 + 4 T71
P7049	2 S8 + 4 T81
P7050	2 S8 + 4 T91
P7051	2 S8 + 4 T101
P7052	2 S8 + 4 T111
P7053	2 S8 + 4 T131
P7054	2 S8 + 4 T141
P7055	2 S8 + 4 T151
P7056	2 S8 + 4 T161
P7057	3 S8 + 8 T81
P7058	3 S8 + 4 T81 + 4 T91
P7059	3 S8 + 8 T91
P7060	3 S8 + 4 T91 + 4 T101
P7061	3 S8 + 8 T101
P7062	3 S8 + 4 T101 + 4 T111
P7063	3 S8 + 8 T111
P7064	3 S8 + 4 T111 + 4 T131
P7065	3 S8 + 8 T131
P7066	3 S8 + 4 T131 + 4 T141
P7067	3 S8 + 8 T141
P7068	3 S8 + 4 T141 + 4 T151
P7069	3 S8 + 8 T151
P7070	3 S8 + 4 T151 + 4 T161
P7071	3 S8 + 8 T161
P7072	4 S8 + 8 T101 + 4 T111
P7073	4 S8 + 4 T101 + 8 T111
P7074	4 S8 + 12 T111
P7075	4 S8 + 8 T111 + 4 T131
P7076	4 S8 + 4 T111 + 8 T131
P7077	4 S8 + 12 T131
P7078	4 S8 + 8 T131 + 4 T141
P7079	4 S8 + 4 T131 + 8 T141
P7080	4 S8 + 12 T141
P7081	4 S8 + 8 T141 + 4 T151
P7082	4 S8 + 4 T141 + 8 T151
P7083	4 S8 + 12 T151
P7084	4 S8 + 8 T151 + 4 T161
P7085	4 S8 + 4 T151 + 8 T161
P7086	4 S8 + 12 T161
P7087	5 S8 + 8 T111 + 8 T131
P7088	5 S8 + 4 T111 + 12 T131
P7089	5 S8 + 16 T131
P7090	5 S8 + 4 T141 + 12 T131
P7091	5 S8 + 8 T131 + 8 T141
P7092	5 S8 + 4 T131 + 12 T141
P7093	5 S8 + 16 T141

REF. 5 niveles 5 levels 5 niveaux 5 Ebenen	DESGLOSE BREAKDOWN COMPOSITION AUFLISTUNG
P7094	2 S9 + 5 T61
P7095	2 S9 + 5 T71
P7096	2 S9 + 5 T81
P7097	2 S9 + 5 T91
P7098	2 S9 + 5 T101
P7099	2 S9 + 5 T111
P7100	2 S9 + 5 T131
P7101	2 S9 + 5 T141
P7102	2 S9 + 5 T151
P7103	2 S9 + 5 T161
P7104	3 S9 + 10 T81
P7105	3 S9 + 5 T81 + 5 T91
P7106	3 S9 + 10 T91
P7107	3 S9 + 5 T91 + 5 T101
P7108	3 S9 + 10 T101
P7109	3 S9 + 5 T101 + 5 T111
P7110	3 S9 + 10 T111
P7111	3 S9 + 5 T111 + 5 T131
P7112	3 S9 + 10 T131
P7113	3 S9 + 5 T131 + 5 T141
P7114	3 S9 + 10 T141
P7115	3 S9 + 5 T141 + 5 T151
P7116	3 S9 + 10 T151
P7117	3 S9 + 5 T151 + 5 T161
P7118	3 S9 + 10 T161
P7119	4 S9 + 10 T101 + 5 T111
P7120	4 S9 + 5 T101 + 10 T111
P7121	4 S9 + 15 T111
P7122	4 S9 + 10 T111 + 5 T131
P7123	4 S9 + 5 T111 + 10 T131
P7124	4 S9 + 15 T131
P7125	4 S9 + 10 T131 + 5 T141
P7126	4 S9 + 5 T131 + 10 T141
P7127	4 S9 + 15 T141
P7128	4 S9 + 10 T141 + 5 T151
P7129	4 S9 + 5 T141 + 10 T151
P7130	4 S9 + 15 T151
P7131	4 S9 + 10 T151 + 5 T161
P7132	4 S9 + 5 T151 + 10 T161
P7133	4 S9 + 15 T161
P7134	5 S9 + 10 T111 + 10 T131
P7135	5 S9 + 5 T111 + 15 T131
P7136	5 S9 + 20 T131
P7137	5 S9 + 5 T141 + 15 T131
P7138	5 S9 + 10 T131 + 10 T141
P7139	5 S9 + 5 T131 + 15 T141
P7140	5 S9 + 20 T141

**FONDO 555 MM. ADAPTABLE A GASTRONORM 1/1 / DEEPTH 555 MM. SUITABLE FOR 1/1 GASTRONORM /
PROFONDEUR555 MM. ADAPTABLEAUX GASTRONORME1/1 / TIEFE 555 MM. PASSEND FÜR GASTRONORM 1/1**

REF. 3 niveles 3 levels 3 niveaux 3 Ebenen	DESGLOSE BREAKDOWN COMPOSITION AUFLISTUNG	REF. 4 niveles 4 levels 4 niveaux 4 Ebenen	DESGLOSE BREAKDOWN COMPOSITION AUFLISTUNG	REF. 5 niveles 5 levels 5 niveaux 5 Ebenen	DESGLOSE BREAKDOWN COMPOSITION AUFLISTUNG
P7141	2 S1 + 3 T6	P7188	2 S2 + 4 T6	P7235	2 S3 + 5 T6
P7142	2 S1 + 3 T7	P7189	2 S2 + 4 T7	P7236	2 S3 + 5 T7
P7143	2 S1 + 3 T8	P7190	2 S2 + 4 T8	P7237	2 S3 + 5 T8
P7144	2 S1 + 3 T9	P7191	2 S2 + 4 T9	P7238	2 S3 + 5 T9
P7145	2 S1 + 3 T10	P7192	2 S2 + 4 T10	P7239	2 S3 + 5 T10
P7146	2 S1 + 3 T11	P7193	2 S2 + 4 T11	P7240	2 S3 + 5 T11
P7147	2 S1 + 3 T13	P7194	2 S2 + 4 T13	P7241	2 S3 + 5 T13
P7148	2 S1 + 3 T14	P7195	2 S2 + 4 T14	P7242	2 S3 + 5 T14
P7149	2 S1 + 3 T15	P7196	2 S2 + 4 T15	P7243	2 S3 + 5 T15
P7150	2 S1 + 3 T16	P7197	2 S2 + 4 T16	P7244	2 S3 + 5 T16
P7151	3 S1 + 6 T8	P7198	3 S2 + 8 T8	P7245	3 S3 + 10 T8
P7152	3 S1 + 3 T8 + 3 T9	P7199	3 S2 + 4 T8 + 4 T9	P7246	3 S3 + 5 T8 + 5 T9
P7153	3 S1 + 6 T9	P7200	3 S2 + 8 T9	P7247	3 S3 + 10 T9
P7154	3 S1 + 3 T9 + 3 T10	P7201	3 S2 + 4 T9 + 4 T10	P7248	3 S3 + 5 T9 + 5 T10
P7155	3 S1 + 6 T10	P7202	3 S2 + 8 T10	P7249	3 S3 + 10 T10
P7156	3 S1 + 3 T10 + 3 T11	P7203	3 S2 + 4 T10 + 4 T11	P7250	3 S3 + 5 T10 + 5 T11
P7157	3 S1 + 6 T11	P7204	3 S2 + 8 T11	P7251	3 S3 + 10 T11
P7158	3 S1 + 3 T11 + 3 T13	P7205	3 S2 + 4 T11 + 4 T13	P7252	3 S3 + 5 T11 + 5 T13
P7159	3 S1 + 6 T13	P7206	3 S2 + 8 T13	P7253	3 S3 + 10 T13
P7160	3 S1 + 3 T13 + 3 T14	P7207	3 S2 + 4 T13 + 4 T14	P7254	3 S3 + 5 T13 + 5 T14
P7161	3 S1 + 6 T14	P7208	3 S2 + 8 T14	P7255	3 S3 + 10 T14
P7162	3 S1 + 3 T14 + 3 T15	P7209	3 S2 + 4 T14 + 4 T15	P7256	3 S3 + 5 T14 + 5 T15
P7163	3 S1 + 6 T15	P7210	3 S2 + 8 T15	P7257	3 S3 + 10 T15
P7164	3 S1 + 3 T15 + 3 T16	P7211	3 S2 + 4 T15 + 4 T16	P7258	3 S3 + 5 T15 + 5 T16
P7165	3 S1 + 6 T16	P7212	3 S2 + 8 T16	P7259	3 S3 + 10 T16
P7166	4 S1 + 6 T10 + 3 T11	P7213	4 S2 + 8 T10 + 4 T11	P7260	4 S3 + 10 T10 + 5 T11
P7167	4 S1 + 3 T10 + 6 T11	P7214	4 S2 + 4 T10 + 8 T11	P7261	4 S3 + 5 T10 + 10 T11
P7168	4 S1 + 9 T11	P7215	4 S2 + 12 T11	P7262	4 S3 + 15 T11
P7169	4 S1 + 6 T11 + 3 T13	P7216	4 S2 + 8 T11 + 4 T13	P7263	4 S3 + 10 T11 + 5 T13
P7170	4 S1 + 3 T11 + 6 T13	P7217	4 S2 + 4 T11 + 8 T13	P7264	4 S3 + 5 T11 + 10 T13
P7171	4 S1 + 9 T13	P7218	4 S2 + 12 T13	P7265	4 S3 + 15 T13
P7172	4 S1 + 6 T13 + 3 T14	P7219	4 S2 + 8 T13 + 4 T14	P7266	4 S3 + 10 T13 + 5 T14
P7173	4 S1 + 3 T13 + 6 T14	P7220	4 S2 + 4 T13 + 8 T14	P7267	4 S3 + 5 T13 + 10 T14
P7174	4 S1 + 9 T14	P7221	4 S2 + 12 T14	P7268	4 S3 + 15 T14
P7175	4 S1 + 6 T14 + 3 T15	P7222	4 S2 + 8 T14 + 4 T15	P7269	4 S3 + 10 T14 + 5 T15
P7176	4 S1 + 3 T14 + 6 T15	P7223	4 S2 + 4 T14 + 8 T15	P7270	4 S3 + 5 T14 + 10 T15
P7177	4 S1 + 9 T15	P7224	4 S2 + 12 T15	P7271	4 S3 + 15 T15
P7178	4 S1 + 6 T15 + 3 T16	P7225	4 S2 + 8 T15 + 4 T16	P7272	4 S3 + 10 T15 + 5 T16
P7179	4 S1 + 3 T15 + 6 T16	P7226	4 S2 + 4 T15 + 8 T16	P7273	4 S3 + 5 T15 + 10 T16
P7180	4 S1 + 9 T16	P7227	4 S2 + 12 T16	P7274	4 S3 + 15 T16
P7181	5 S1 + 6 T11 + 6 T13	P7228	5 S2 + 8 T11 + 8 T13	P7275	5 S3 + 10 T11 + 10 T13
P7182	5 S1 + 3 T11 + 9 T13	P7229	5 S2 + 4 T11 + 12 T13	P7276	5 S3 + 5 T11 + 15 T13
P7183	5 S1 + 12 T13	P7230	5 S2 + 16 T13	P7277	5 S3 + 20 T13
P7184	5 S1 + 3 T14 + 9 T13	P7231	5 S2 + 4 T14 + 12 T13	P7278	5 S3 + 5 T14 + 15 T13
P7185	5 S1 + 6 T13 + 6 T14	P7232	5 S2 + 8 T13 + 8 T14	P7279	5 S3 + 10 T13 + 10 T14
P7186	5 S1 + 3 T13 + 9 T14	P7233	5 S2 + 4 T13 + 12 T14	P7280	5 S3 + 5 T13 + 15 T14
P7187	5 S1 + 12 T14	P7234	5 S2 + 16 T14	P7281	5 S3 + 20 T14

**FONDO 555 MM. ADAPTABLE A GASTRONORM 1/1 / DEPTH 555 MM. SUITABLE FOR 1/1 GASTRONORM /
PROFONDEUR 555 MM. ADAPTABLEAUX GASTRONORME 1/1 / TIEFE 555 MM. PASSEND FÜR GASTRONORM 1/1**

REF. 3 niveles 3 levels 3 niveaux 3 Ebenen	DESGLASE BREAKDOWN COMPOSITION AUFLISTUNG	REF. 4 niveles 4 levels 4 niveaux 4 Ebenen	DESGLASE BREAKDOWN COMPOSITION AUFLISTUNG	REF. 5 niveles 5 levels 5 niveaux 5 Ebenen	DESGLASE BREAKDOWN COMPOSITION AUFLISTUNG
P7423	1 S1 + 3 T6	P7470	1 S2 + 4 T6	P7517	1 S3 + 5 T6
P7424	1 S1 + 3 T7	P7471	1 S2 + 4 T7	P7518	1 S3 + 5 T7
P7425	1 S1 + 3 T8	P7472	1 S2 + 4 T8	P7519	1 S3 + 5 T8
P7426	1 S1 + 3 T9	P7473	1 S2 + 4 T9	P7520	1 S3 + 5 T9
P7427	1 S1 + 3 T10	P7474	1 S2 + 4 T10	P7521	1 S3 + 5 T10
P7428	1 S1 + 3 T11	P7475	1 S2 + 4 T11	P7522	1 S3 + 5 T11
P7429	1 S1 + 3 T13	P7476	1 S2 + 4 T13	P7523	1 S3 + 5 T13
P7430	1 S1 + 3 T14	P7477	1 S2 + 4 T14	P7524	1 S3 + 5 T14
P7431	1 S1 + 3 T15	P7478	1 S2 + 4 T15	P7525	1 S3 + 5 T15
P7432	1 S1 + 3 T16	P7479	1 S2 + 4 T16	P7526	1 S3 + 5 T16
P7433	2 S1 + 6 T8	P7480	2 S2 + 8 T8	P7527	2 S3 + 10 T8
P7434	2 S1 + 3 T8 + 3 T9	P7481	2 S2 + 4 T8 + 4 T9	P7528	2 S3 + 5 T8 + 5 T9
P7435	2 S1 + 6 T9	P7482	2 S2 + 8 T9	P7529	2 S3 + 10 T9
P7436	2 S1 + 3 T9 + 3 T10	P7483	2 S2 + 4 T9 + 4 T10	P7530	2 S3 + 5 T9 + 5 T10
P7437	2 S1 + 6 T10	P7484	2 S2 + 8 T10	P7531	2 S3 + 10 T10
P7438	2 S1 + 3 T10 + 3 T11	P7485	2 S2 + 4 T10 + 4 T11	P7532	2 S3 + 5 T10 + 5 T11
P7439	2 S1 + 6 T11	P7486	2 S2 + 8 T11	P7533	2 S3 + 10 T11
P7440	2 S1 + 3 T11 + 3 T13	P7487	2 S2 + 4 T11 + 4 T13	P7534	2 S3 + 5 T11 + 5 T13
P7441	2 S1 + 6 T13	P7488	2 S2 + 8 T13	P7535	2 S3 + 10 T13
P7442	2 S1 + 3 T13 + 3 T14	P7489	2 S2 + 4 T13 + 4 T14	P7536	2 S3 + 5 T13 + 5 T14
P7443	2 S1 + 6 T14	P7490	2 S2 + 8 T14	P7537	2 S3 + 10 T14
P7444	2 S1 + 3 T14 + 3 T15	P7491	2 S2 + 4 T14 + 4 T15	P7538	2 S3 + 5 T14 + 5 T15
P7445	2 S1 + 6 T15	P7492	2 S2 + 8 T15	P7539	2 S3 + 10 T15
P7446	2 S1 + 3 T15 + 3 T16	P7493	2 S2 + 4 T15 + 4 T16	P7540	2 S3 + 5 T15 + 5 T16
P7447	2 S1 + 6 T16	P7494	2 S2 + 8 T16	P7541	2 S3 + 10 T16
P7448	3 S1 + 6 T10 + 3 T11	P7495	3 S2 + 8 T10 + 4 T11	P7542	3 S3 + 10 T10 + 5 T11
P7449	3 S1 + 3 T10 + 6 T11	P7496	3 S2 + 4 T10 + 8 T11	P7543	3 S3 + 5 T10 + 10 T11
P7450	3 S1 + 9 T11	P7497	3 S2 + 12 T11	P7544	3 S3 + 15 T11
P7451	3 S1 + 6 T11 + 3 T13	P7498	3 S2 + 8 T11 + 4 T13	P7545	3 S3 + 10 T11 + 5 T13
P7452	3 S1 + 3 T11 + 6 T13	P7499	3 S2 + 4 T11 + 8 T13	P7546	3 S3 + 5 T11 + 10 T13
P7453	3 S1 + 9 T13	P7500	3 S2 + 12 T13	P7547	3 S3 + 15 T13
P7454	3 S1 + 6 T13 + 3 T14	P7501	3 S2 + 8 T13 + 4 T14	P7548	3 S3 + 10 T13 + 5 T14
P7455	3 S1 + 3 T13 + 6 T14	P7502	3 S2 + 4 T13 + 8 T14	P7549	3 S3 + 5 T13 + 10 T14
P7456	3 S1 + 9 T14	P7503	3 S2 + 12 T14	P7550	3 S3 + 15 T14
P7457	3 S1 + 6 T14 + 3 T15	P7504	3 S2 + 8 T14 + 4 T15	P7551	3 S3 + 10 T14 + 5 T15
P7458	3 S1 + 3 T14 + 6 T15	P7505	3 S2 + 4 T14 + 8 T15	P7552	3 S3 + 5 T14 + 10 T15
P7459	3 S1 + 9 T15	P7506	3 S2 + 12 T15	P7553	3 S3 + 15 T15
P7460	3 S1 + 6 T15 + 3 T16	P7507	3 S2 + 8 T15 + 4 T16	P7554	3 S3 + 10 T15 + 5 T16
P7461	3 S1 + 3 T15 + 6 T16	P7508	3 S2 + 4 T15 + 8 T16	P7555	3 S3 + 5 T15 + 10 T16
P7462	3 S1 + 9 T16	P7509	3 S2 + 12 T16	P7556	3 S3 + 15 T16
P7463	4 S1 + 6 T11 + 6 T13	P7510	4 S2 + 8 T11 + 8 T13	P7557	4 S3 + 10 T11 + 10 T13
P7464	4 S1 + 3 T11 + 9 T13	P7511	4 S2 + 4 T11 + 12 T13	P7558	4 S3 + 5 T11 + 15 T13
P7465	4 S1 + 12 T13	P7512	4 S2 + 16 T13	P7559	4 S3 + 20 T13
P7466	4 S1 + 3 T14 + 9 T13	P7513	4 S2 + 4 T14 + 12 T13	P7560	4 S3 + 5 T14 + 15 T13
P7467	4 S1 + 6 T13 + 6 T14	P7514	4 S2 + 8 T13 + 8 T14	P7561	4 S3 + 10 T13 + 10 T14
P7468	4 S1 + 3 T13 + 9 T14	P7515	4 S2 + 4 T13 + 12 T14	P7562	4 S3 + 5 T13 + 15 T14
P7469	4 S1 + 12 T14	P7516	4 S2 + 16 T14	P7563	4 S3 + 20 T14



12.1 COCCIÓN / COOKING / COUSSION/ KÜCHENMACHINEN 284

Placas inducción / Induction units / Plaque induction / Induktionseplatten	288
Placas inducción mantenedoras / Warming induction units / Plaque induction de maintien température / Warmhalte-induktionsplatte	291
Hornos y micro-ondas / Ovens & micro-waves / Fours et micro-ondes / Ofen und mikrowellen	293
Freidoras / Fryers / Friteuses / Friteusen	295
Crepera & gofrera / Crepe & waffle equipment / Crêpière & gaufrier / Crepes & waffel	296

12.2 TOSTADORAS Y GRILL DE CONTACTO / TOASTEURS & CONTACT GRILLS / TOASTER ET GRILL DE CONTACT / TOASTER - KONTACKGRILL 298

Tostadoras / Toasters / Toasteurs / Toaster	298
Grill de contacto / Contact grill / Grill de contact / Kontaktgrill	304

12.3 PROCESADORES DE ALIMENTOS / FOOD PROCESSORS / ROBOTSMULTIFONCTION / LEBENSMITTELMASCHINE 305

Batidoras planetarias / Mixers / Mélangeurs / Mixers	306
Corta fiambres / Slicing machines / Trancheurs / Aufschnittmaschine	307
Brazos trituradores / Stick blenders / Bras mixeurs / Mixer	308
Batidoras / Blenders / Mixeurs / Mixer	313

12.4 MAQUINARIA MANTENEDORA DE TEMPERATURA / FOOD WARMING EQUIPMENT / APPAREILS DE MAINTEN DE TEMPEÉRATURE/ WARMHALTEMASCHINEN 320

Rethermalizadores / Rethermalizers / Appareil de remise en température / Rethermalisier	322
Baños maría / Bain marie / Bain-marie / Wasserbad	326
Lámparas mantenedoras / Heating lamps / Lampe chauffante / Wärmelampen	331
Armarios calientes / Hot banquet trolleys / Armoires chaudes / Warmhalteschranke	335

12.5 MAQUINARIA HELADERÍA / ICE-CREAM MACHINES / TURBINES À GLACE/ EISMASCHINEN 338

PLACAS INDUCCIÓN / INDUCTION HOBS / PLAQUES INDUCTION / INDUKTIONSFELDER

La nueva forma de cocinar: más eficiente,
más rápida, más segura y más precisa /

*The new way of cooking: more efficient, faster,
safer and more precise /*

La nouvelle manière de cuisiner : plus
efficace, plus rapide, plus sûre et plus précise /

*Die neue form zu kochen: effizienter, schneller,
sicherer und präziser*



1 Rapidez / Speed / Rapidité / Schnelligkeit

Siendo transmitido directamente a la olla,
el calor, se concentra donde se necesita
ahorrando energía y, obviamente, tiempo /

*As heat is directly transmitted to the pan, it will
be concentrated where it is needed, saving both
energy and time /*

La chaleur étant transmise directement à
la casserole, elle se concentre là où elle est
nécessaire en économisant de l'énergie et, bien
sûr, du temps /

*Da die hitze direkt auf den topf übertragen wird
diese konzentriert und so energie und natürlich
zeit gespart*

2 Precisión / Precision / Précision / Präzision

Gracias a su sensibilidad, las placas de inducción
conceden al cocinero una capacidad de control
incomparable con las cocinas tradicionales /

*Thanks to their sensitivity, induction hobs give the chef an
unbeatable ability to control the heat when compared to
traditional hobs /*

Grâce à leur sensibilité, les plaques à induction offrent
au cuisinier une capacité de contrôle sans comparaison
avec les cuisinières traditionnelles /

*Dank ihrer sensibilität bieten die induktionsplatten dem
koch eine unvergleichliche kontrolle gegenüber traditioneller
herde*



Cocina de inducción /
Induction hob /
Cuisinière à induction /
Induktionsherd



Cocina de gas /
Gas hob /
Cuisinière à gaz /
Gasherd

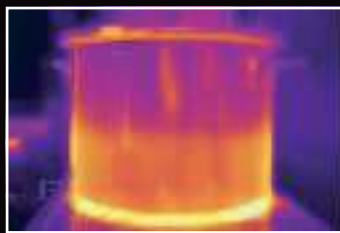

Cocina de inducción / Induction hob /
Cuisinière à induction / Induktionsherd

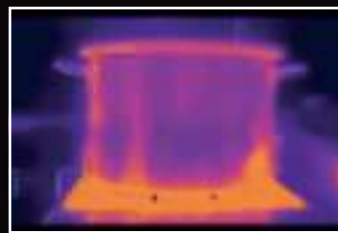

Cocina de gas / Gas hob /
Cuisinière à gaz / Gasherd



3

Eficiencia energética / Energy efficient / Efficacité énergétique / Energieeffizienz

El campo electromagnético producido por las placas de inducción transmite el calor directamente a la pieza evitando la dispersión de energía que se genera cocinando con gas /

The electromagnetic field produced by induction hobs transmits the heat directly to the pan, avoiding the dispersal of energy that happens when cooking with gas /

Le champ électromagnétique produit par les plaques à induction transmet la chaleur directement à la pièce en évitant la déperdition d'énergie générée quand on cuisine au gaz /

Das elektromagnetische feld, das durch die induktionsplatten entsteht, überträgt die hitze direkt auf den topf. So wird eine hitzestreuung, die bei gasherden auftritt, vermieden

4

Seguridad / Safety / Sécurité / Sicherheit

Sin una pieza específica que active el campo magnético, las placas de inducción no se calientan /
Without anything on the hob to activate the magnetic field, the induction hobs do not heat up /

À défaut d'une pièce adaptée capable d'activer le champ magnétique, les plaques ne chauffent pas /

Ohne ein spezialteil, das das magnetfeld aktiviert, erwärmen sich die induktionsplatten nicht





**PLACAS INDUCCIÓN / INDUCTION UNITS /
 PLAQUE INDUCTION / INDUKTIONSPLATTEN**

**COCINADO /
 COOKING /
 CUISSON /
 KOCHGERÄT**

Marca / Brand / Marque / Marke					
---	---	---	---	---	---



Modelo / Model / Modèle / Modell	59650	59601	6954702	P15078	P15072
Potencia (W) / Power (W) / Puissance (W) / Leistung (W)	1.800	1.800	3.800	3.500	3.500
Diámetro máx. (cm) / Max. diameter (cm) / Diamètre max. (cm) / Max. Durchmesser (cm)	26	36	30 x 2	26	26
Disipación calor / Heat dissipation / Dissipation de chaleur / Wärmeabgabe					
Tipo / Type / Type / Typ	Sobremesa Counter-top À poser sur table Tischgerät	Sobremesa Counter-top À poser sur table Tischgerät	Sobremesa Counter-top À poser sur table Tischgerät	Sobremesa Counter-top À poser sur table Tischgerät	Sobremesa Counter-top À poser sur table Tischgerät
Apto / Suitable / Convient / Geeignet	Ollas / Sartenes Pots / Pans Casseroles / Poêles Töpfe / Pfannen	Ollas / Sartenes Pots / Pans Casseroles / Poêles Töpfe / Pfannen	Ollas / Sartenes Pots / Pans Casseroles / Poêles Töpfe / Pfannen	Ollas / Sartenes Pots / Pans Casseroles / Poêles Töpfe / Pfannen	Ollas / Sartenes Pots / Pans Casseroles / Poêles Töpfe / Pfannen
Uso / Use / Usage / Gebrauch	Intensivo Intensive Intensif Intensiv	Intensivo Intensive Intensif Intensiv	Intensivo Intensive Intensif Intensiv	Semi-intensivo Semi-intensive Semi-intensif Häufig	Semi-intensivo Semi-intensive Semi-intensif Häufig

PLACAS INDUCCIÓN / INDUCTION UNITS /
 PLAQUE INDUCTION / INDUKTIONSPLATTEN

MANTENIMIENTO TEMPERATURA /
 TEMPERATURE MAINTENANCE /
 MAINTIEN EN TEMPÉRATURE /
 WARMHALTEN

					
					
P15079	P15077	P688065	595027502	595087502	59641
3.500	2.000	3.100	300	375	650
26	26	40	40	60	36
					
Sobremesa Counter-top À poser sur table Tischgerät	Sobremesa Counter-top À poser sur table Tischgerät	Sobremesa Counter-top À poser sur table Tischgerät	Sobremesa Counter-top À poser sur table Tischgerät	Sobremesa Counter-top À poser sur table Tischgerät	Encastrable Be built-in Encastrable Einbaubar
Ollas / Sartenes Pots / Pans Casseroles / Poêles Töpfe / Pfannen	Ollas / Sartenes Pots / Pans Casseroles / Poêles Töpfe / Pfannen	Wok	Ollas / Chaffing Pots / Chaffing dishes Casseroles / Chauffe-plats Töpfe / Warmhalten	Ollas / Chaffing Pots / Chaffing dishes Casseroles / Chauffe-plats Töpfe / Warmhalten	Ollas / Chaffing Pots / Chaffing dishes Casseroles / Chauffe-plats Töpfe / Warmhalten
Semi-intensivo Semi-intensive Semi-intensif Häufig	Moderado Moderate Modéré Mäßig	Semi-intensivo Semi-intensive Semi-intensif Häufig	Intensivo Intensive Intensif Intensiv	Intensivo Intensive Intensif Intensiv	Intensivo Intensive Intensif Intensiv

mirage®

INDUCTION

100
 Niveles de potencia /
 Power levels /
 Niveaux de puissance /
 Leistungsstufen

1-180 min
 Temporizador /
 Timer /
 Minuterie /
 Timer

LED
 Pantalla /
 Display /
 Ecran /
 Display

Memoria de temperatura – permite usar el último ajuste de temperatura programado. Cuadro de selección de temperatura y potencia /

Temperature memory — powers up to the last used temperature setting. Cutting-edge dial control with high-speed power and temperature level adjustment /

Mémoire de température – offre la possibilité d'utiliser le dernier réglage de température. Cadran de réglage avant-gardiste permettant un réglage rapide de la température et de la puissance /

Temperaturspeicher – beim Einschalten wird die zuletzt verwendete Temperatureinstellung wieder verwendet. Hochmoderne Wahlscheibenbedienung mit Hochgeschwindigkeitseinstellung der Leistungs- und Temperaturstufe.

Resistente caja de acero inoxidable con superficie cerámica 100% sellada /

Tough stainless steel case with 100% framed ceramic top for durability /

Boîtier inox solide avec une surface supérieure à 100 % en céramique afin de garantir de une durée de vie plus longue /

Robustes Edelstahlgehäuse mit zu 100 % gerahmtem Oberteil verbessert die Haltbarkeit.



59650 Placa inducción / Induction cooker / Plaque induction / Induktionskochplatten

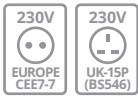

REF	Ø Mx cm	V	W	A	ENCH. PLUG	Hz	☐
59650	26	230	1.800	7,8	EU	50/60	1
59651	26	230	1.800	7,8	UK	50/60	1

Vidrio cerámico /
 Ceramic glass /
 Vitrocéramique /
 Glaskeramik



Potenciometro regulable /
 Adjustable potentiometer /
 Potentiomètre réglable /
 Temperaturregler

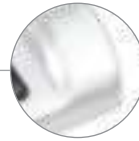

Carcasa antirradiación /
 Anti-radiation housing /
 Carcasseantiradiation /
 Strahlenschutzgehäuse

59601 Placa inducción encastrable / Drop in induction cooker / Plaque induction encastrable / Einsetzbare Induktionsplatte

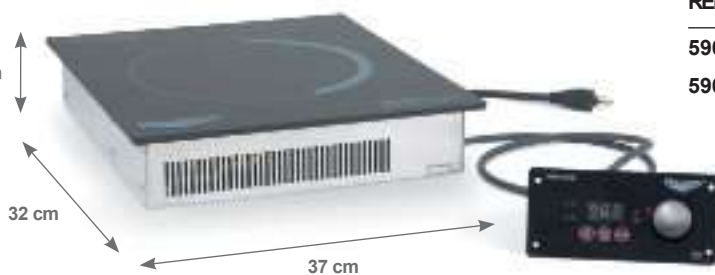

REF	Ø Mx cm	cm	V	W	A	ENCH. PLUG	Hz	☐
59601	36	34 x 30	230	1.800	7,8	EU	50/60	1
59602	36	34 x 30	230	1.800	7,8	UK	50/60	1

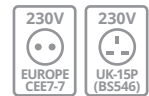

Control con ajuste de alta velocidad para nivel de potencia y temperatura. Cuerpo resistente de acero inoxidable con superficie cerámica. Memoria de temperatura, permite utilizar el último ajuste de temperatura usado.

Cutting-edge dial control with high-speed power and temperature level adjustment. Tough stainless steel case with 100% framed ceramic top for durability. Temperature memory — powers up to the last used temperature setting.

Cadran de réglage à la pointe de la technique permettant le réglage rapide de la température et de la puissance. Boîtier inox solide avec dessus 100 % céramique pour plus de durabilité. Mémoire de température – monte au dernier réglage de température utilisé.

Hochmoderne Wahlscheibenbedienung mit Hochgeschwindigkeitseinstellung der Leistungs- und Temperaturstufe. Robustes Edelstahlgehäuse mit zu 100 % gerahmtem Oberteil verbessert die Haltbarkeit. Temperaturspeicher – beim Einschalten wird die zuletzt verwendete Temperatureinstellung wieder verwendet.

69547 Placa inducción doble / Double induction plate / Plaque à induction double / Doppel-Induktionskochplatte



REF	Ø cm	V	W	A	ENCH. PLUG	Hz	
6954702	30 x 2	208-240	3.800	15,8	EU	50/60	1
6954703	30 x 2	208-240	3.800	15,8	UK	50/60	1



**Placas inducción estándar / Standard Induction /
Plaque induction standard / Induktionsplattenstandard**

P688065 Placa de inducción wok / Wok induction cooker / Plaque à induction wok / Induktionskochfeld wok



REF	Ø cm	V	W	ENCH. PLUG	Hz	
P688.065	36/40	220-240	3.100	EU	50/60	1

Cuerpo en acero inoxidable. Reloj temporizador (0-180 minutos). Pantalla LED. Temperatura 60-240 °C. 4 ventiladores.

St/steel housing. Timer (0-180 minutes). LED display. Temperatures: 60-240 °C. 4 fans.

Corps en acier inoxydable. Minuteur (0-180 minutes). Ecran LED. Température 60-240 °C. 4 ventilateurs.

Gehäuse aus rostfreiem Stahl. Timer (0-180 Minuten). LED Display. Temperaturbereich von 60-240 °C. 4 Kühlventilatoren.

P15078 Placa de inducción / Induction cooker / Plaque à induction / Induktionskochfeld



REF	Ø Mx cm	V	W	Hz	
P15.078	26	220 - 240	3.500	50/60	1

Cuerpo en acero inoxidable. Reloj temporizador (0-180 minutos). Pantalla LED con control táctil. Regulador de temperatura 1-10 (500-3500W). Rango temperatura 60-240 °C. Cuatro ventiladores de refrigeración.

St/steel housing. Timer. LED display (0-180 minutes). Touch control. 1-10 Power level (500-3500W). Temperatures: 60-240 °C. Four fans.

Corps en acier inoxydable. Minuteur. Ecran LED (0-180 minutes). Tactile. 1-10 Niveau de puissance (500-3500W). Température 60-240 °C. Quatre ventilateurs.

Gehäuse aus rostfreiem Stahl. Timer. Timer (0-180 Minuten). LED Display mit Touch control. Temperaturregler 1-10 (500-3500W). Temperaturbereich von 60-240 °C. 4 Kühlventilatoren.

MAQUINARIA /
EQUIPMENT /
EQUIPMENT

Ver productos en / See products on / Voir produits en page / Siehe produkte in P. 66 P. 71

WOKS



P15072 Placa de inducción / Induction cooker / Plaque à induction / Induktionskochfeld



REF	Ø Màx cm	V	W	Hz	
P15.072	26	230	3.500	50/60	1

Cuerpo en acero inoxidable. Mando digital de tiempo de 0-180 minutos. Temperatura de 60-240 °C. Potencia de 500-3500 W. 4 Ventiladores.

St/Steel housing. Digital regulation of time 0-180 minutes, thermostat 60-240 °C and power 500-3500 W. 4 Fans.

Corps en acier inoxydable. Minuterie digitale de 0-180 minutes. Température de 60-240 °C. Puissance: 500-3500 W. 4 Ventilateurs.

Gehäuse aus rostfreiem Stahl. Digitale Timersteuerung von 0-180 Minuten. Temperatur von 60-240 °C. Leistung von 500-3500 W. 4 Kühlventilatoren.

P15079 Placa de inducción / Induction cooker / Plaque à induction / Induktionskochfeld



REF	Ø Màx cm	V	W	Hz	
P15.079	26	230	3.500	50/60	1

Cuerpo en acero inoxidable. Reloj temporizador (0-180 minutos). Pantalla LED. Rango temperatura 60-240 °C. Un ventilador de refrigeración.

St/steel housing. Timer. LED display (0-180 minutes). Temperatures: 60-240 °C. One fan.

Corps en acier inoxydable. Minuteur. Ecran LED (0-180 minutes). Temperatures: 60-240 °C. Un ventilateur.

Gehäuse aus rostfreiem Stahl. Timer von 0-180 Minuten. LED Display. Temperaturbereich von 60-240 °C. 1 Kühlventilator.

P15077 Placa de inducción pequeña / Induction cooker / Plaque induction petite / Kleines induktionskochfeld



REF	Ø Màx cm	V	W	Hz	
P15.077	26	230	2.000	50/60	1

Cuerpo en plástico con panel control táctil LCD. Reloj temporizador (0-180 minutos). Rango temperaturas: 60-240 °C.

Plastic housing with touch control LCD panel. Timer (0-180 minutes). Temperatures: 60-240 °C.

Corps en plastique avec écran LCD tactile. Minuteur (0-180 minutes). Temperatures: 60-240 °C.

Gehäuse aus Plastik. Touch Control LCD Bildschirm. Timer (0-180 Minuten). Temperaturbereich von 60-240 °C.

MIRAGE®



INDUCTION

BUFET CALENTADORES INDUCCIÓN / BUFFET INDUCTION WARMER / BUFFETRECHAUD INDUCTION / BÜFFET-INDUKTIONS-RECHAUD

Mantener la comida caliente durante el servicio.
Low wattage to keep food warm during serving.
 Faible puissance pour garder les aliments au chaud pendant le service.
 Geringer Wattverbrauch zum Warmhalten der Speisen beim Servieren.

Con menos de 400W son el sistema más eficiente y eco-friendly del mercado.
With less than 400W, it is the most efficient and eco-friendly system on the market.
 Avec moins de 400 W c'est le système le plus efficace et eco-friendly du marché.
 Mit weniger als 400 W sind sie das effizienteste und umweltfreundlichste System auf dem Markt.

Parte superior de cristal templado negro.
Tempered, black glass top.
 Plateau en verre noir trempé.
 Haube aus schwarzem gehärtetem Glas.

Con 4 ajustes de potencia. Indicadores luminosos LED en el panel de control.
Touch control, 4 power settings. LED indicator lights on control panel & glass.
 Contrôle tactile, 4 réglages de puissance. Voyants LED lumineux sur le panneau de commande et verre.
 Touch Control mit 4 Stufen. LED-Anzeigeleuchten auf Steuerpanel und Glas.



Conecte hasta 3 placas a la vez.
Connect up to 3 units together with interconnect cords.
 Connectez jusqu'à 3 unités avec des cordons d'interconnexion.
 Schließen Sie bis zu 3 Geräte mit einer Weiterverbindungs-Geräteanschlussleitung an.

595027502 Placa inducción mantenedora de temperatura / Buffet induction warmer / Plaque induction de maintien température / Warmhalte-Induktionsplatte



595087502
 595087503



595027502
 595027503

REF	mm	VOLT. CA/ AC	W	A	ENCH. PLUG	Hz	
595027502	400 x 400 x 80	230	300	1,30	EU	50/60	1
595027503	400 x 400 x 80	230	300	1,30	UK	50/60	1
595087502	600 x 400 x 80	230	375	1,63	EU	50/60	1
595087503	600 x 400 x 80	230	375	1,63	UK	50/60	1

MAQUINARIA /
 EQUIPMENT /
 EQUIPEMENT

12.1 MANTENEDORES DE TEMPERATURA / WARMING EQUIPMENT /
MAINTENANCE DE TEMPÉRATURE / WARMHALTEMASCHINEN



59641 Placa inducción mantenedora de temperatura encastrable / Drop in warmer /
Plaque induction de maintien température encastrable / Einsetzbare Warmhalte-Induktionsplatte

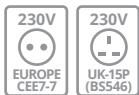

REF	Ø MÀX cm	cm*	VOLT. CA/ AC	W	A	ENCH. PLUG	Hz	
59641	36	34 x 30	230	650	2,8	EU	50/60	1
59642	36	34 x 30	230	650	2,8	UK	50/60	1

* Encastrable / Drop in / Encastrable / Einsetzbare



P15035 Horno multifuncional de convección / Convection oven /
 Four à air pulse / Multifunktionseller Konvektionsbackofen



REF	Rejilla / Grill / Grille / Rost	V	W	
P15.035	43 x 32	230	2.670	1

4 rejillas incluidas / 4 grids included /
 4 grilles incluses / 4 Roste inklusive



Temporizador, pilotos luminosos, termostato (max. 300 °C), termostato de seguridad y doble vidrio anti-quemaduras.
Timer, indicator lights, thermostat, (max. 300 °C) thermal cut-out and double glass.

Avec minuterie, voyants lumineux, thermostat (max. 300 °C), thermostat de sécurité et avec double vitre. mostat, thermostat de sécurité et avec vitre double.
Timer, Kontrollleuchten, Thermostat (max. 300 °C), Sicherheitsthermostat und Doppelglas gegen Verbrennungen.

P15080 Microondas combi / Combi micro - wave / Four micro - ondes / Kombi - Mikrowelle



REF	Lts	Dim int / Inner sizes / Dim. int. / Innenmasse cm	V	Max W	Hz	
P15.080	25,0	33,5 x 33,5 x 17	230	1.950	50	1



Input: 1.400 W
Output: 900 W
Grill: 1.950 W
Convección / Convection / Konvektion: 1.950 W

Ø plato giratorio / Glass round dish /
 Plateau tournant / Drehplatte **27 cm**

Funciones: descongelar, gratinar y calentar
Functions: defrosting, baking and heating
 Fonctions: décongeler, gratiner et chauffer
 Funktionen: Auftauen, überbacken und erhitzen

10

Niveles de potencia / Power levels /
 Niveaux de puissance / Leistungsstufen



Freidoras equipadas con un termostato EGO, un termostato de seguridad, luces piloto indicadoras y zona fría. Las unidades de calentamiento se quitan y ponen fácilmente para facilitar la limpieza. Temperatura variable hasta 190 °C. Las cubas llevan asas entrantes móviles (15070, 15071, 15000, 15001).

The deep fat fryers equipped with EGO thermostat, thermal cut-out, indicator lights, cold zone. The heating unit is easily removable and thus facilitating maintenance and cleaning. Variable temperature control up to 190 °C. Removable inner pan with recessed handles (15070, 15071, 15000, 15001).

Les friteuses sont équipées d'un thermostat EGO, un thermostat de sécurité, des voyants lumineux et une zone froide. Résistance amovible pour faciliter le nettoyage. Température variable jusqu'à 190 °C. Les cuves, avec anses pliables, sont amovibles (15070, 15071, 15000, 15001).

Fritteuse hergestellt ausgestattet mit EGO-Thermostat, ein Sicherheitsthermostat, Kontrolllichter und kalte Zone. Zur besseren Reinigung lassen sich die Hitzelemente einfach herausnehmen und zusammenbauen. Variable Temperatur bis 190 °C. Die Frittierkörbe werden mit abnehmbaren Griffen geliefert (15070, 15071, 15000, 15001).

P15070 Freidora 5 lts / 5 lts fryer /
Friteuse 5 lts / 5 Liter Fritteuse

INOX - ST/STEEL
EDELSTAHL
18/10

Mango termoresistente /
Thermo-resistant handle /
Manche thermorésistant /
Hitzebeständiger Griff

Control de temperatura /
Temperature control /
Contrôle de la température /
Temperaturregler



REF	Lts	V	W	Hz	
P15.070	5,00	230	2.000	50/60	1

Medida cesta / Basket size / Mesure panier / Frittierkorbgröße 21 x 14 x 12,5 cm

P15071 Freidora 5+5 lts / 5+5 lts fryer /
Friteuse 5+5 lts / 5+5 Liter Fritteuse

INOX - ST/STEEL
EDELSTAHL
18/10



REF	Lts	V	W	Hz	
P15.071	5,00+5,00	2 x 230	2 x 2.000	50/60	1

Medida cesta / Basket size / Mesure panier / Frittierkorbgröße 21 x 14 x 12,5 cm

P15000 Freidora 8 lts / 8 lts Fryer /
Friteuse 8 lts / 8 Liter Fritteuse

INOX - ST/STEEL
EDELSTAHL
18/10



REF	Lts	V	W	Hz	
P15.000	8,00	230	3.250	50/60	1

Medida cesta / Basket size / Mesure panier / Frittierkorbgröße 24 x 18 x 14 cm

P15001 Freidora 8+8 lts / 8+8 lts Fryer /
Friteuse 8+8 lts / 8+8 Liter Fritteuse

INOX - ST/STEEL
EDELSTAHL
18/10



REF	Lts	V	W	Hz	
P15.001	8,00+8,00	2 x 230	2 x 3.250	50/60	1

Medida cesta / Basket size / Mesure panier / Frittierkorbgröße 24 x 18 x 14 cm

Freidora 8 lts con grifo de vaciado /
8 lts fryer with drainage tap /
Friteuse 8 lts avec robinet vidange /
8 Liter Fritteuse mit Ablaufhahn

P15002



INOX - ST/STEEL
EDELSTAHL
18/10

Grifo de drenaje /
Drain valve /
Robinet de vidange /
Ablasshahn



REF	Lts	V	W	Hz	
P15.002	8,00	230	3.250	50/60	1

Medida cesta / Basket size / Mesure panier / Frittierkorbgröße 24 x 18 x 14 cm

Freidora 8+8 lts con grifo de vaciado /
8+8 lts fryer with drainage tap /
Friteuse 8+8 lts avec robinet vidange /
8+8 Liter Fritteuse mit Ablaufhahn

P15003



INOX - ST/STEEL
EDELSTAHL
18/10



REF	Lts	V	W	Hz	
P15.003	8,00+8,00	2 x 230	2 x 3.250	50/60	1

Medida cesta / Basket size / Mesure panier / Frittierkorbgröße 24 x 18 x 14 cm

P688085 Hervidor de arroz / Rice cooker / Cuisneur à riz / Reiskocher



REF	Ø cm	Capacidad arroz / Rice capacity / Riz capacite / Reis kapazität Kg	Lts	H cm	V	W	Hz	
P688.085	46	3,0	5,40	40	220-230	1.950	50/60	1
P688.087	56	6,1	8,20	40	220-240	2.500	50/60	1



Ref: P688.085



Ref: P688.087



P15075 Crêpera / Crêpe maker / Crêpière / Crêpe

Termostato / Thermostat / Thermostat / Thermostat :
 Temp. Max 300 °C

REF	Ø cm	cm	V	W	Hz	
P15.075	40	45 x 49	230	3.000	50/60	1



Acero inoxidable con planchas de
 hierro fundido teflonadas.
 Indicador temperatura, cajón y
 espátula.

St/Steel with cast iron teflon coated
 plates. Indicator light, drawer/
 warming tray and batter spreader.

Acier inoxydable avec plaques en
 fonte avec revêtement en téflon.
 Témoin de contrôle, tiroir/plaque
 chauffante et étaleur de pâte.

Rostfreier Stahl und Platten aus
 Teflon- Gusseisen. Temperaturanzeige,
 Schublade und Spachtel.

BUBBLE WAFFLE

Gofrera con base de burbujas / Waffle-press with bubbled base /
 Gaufrier à bulles / Waffeleisen mit Bubble-Backplatte



REF	Cap. Max.	Tipo / Type	Ø cm	V	W	Hz	
WBW300XCE	25 u/h	sencilla/ single	19	230	1.200	50/60	1

Moldes con triple capa
 antiadherente, para retirar
 fácilmente los gofres y limpiar
 rápidamente el aparato.

Triple-coated nonstick plates allow
 for easy removal of waffle and quick
 cleanup.

Plaques à triple revêtement
 antiadhésif, pour retirer facilement
 les gaufres et nettoyer rapidement.

Formen mit dreifacher
 Antihaftbeschichtung, um die Waffeln
 einfach abzulösen und für eine
 einfache und schnelle Reinigung.

WW180E / WW200E

Gofrera profesional / Heavy - duty waffle maker /
Gaufrier professionnelle / Professionelles Waffeleisen



Ø 18 cm
H 2,5 cm
Gofre / Waffle /
Gaufre / Waffel



REF	Cap. Max.	Max. U DÍA / DAY / JOURNÉE / TAG	Tipo / Type	Ø cm	V	W	Hz	
WW180XCE	25 u/h	100	sencilla / single	19,5	230	1.200	50/60	1
WW200E	50 u/h	200	doble / double	19,5 x 2	230	1.400	50/60	1

Moldes con triple capa antiadherente, para retirar fácilmente los gofres y limpiar rápidamente el aparato.

Triple-coated nonstick plates allow for easy removal of waffle and quick cleanup.

Plaques à triple revêtement antiadhésif, pour retirer facilement les gaufres et nettoyer rapidement.

Formen mit dreifacher Antihafbeschichtung, um die Waffeln einfach abzulösen und für eine einfache und schnelle Reinigung.

WWCM180E

Máquina profesional para hacer conos de galleta / Professional machine for making waffle cones /
Machine professionnelle pour faire des cônes en biscuit / Gewerbliche Maschine zur Herstellung von Waffeltüten



3 mm
Espesor conos galleta / Waffle cones thickness /
Epaisseur cônes biscuit / Waffeltüten dicke



Ref. CAC121
Incluido / Included / Inclus / Inklusiv

REF	Cap. Max.	Tipo / Type	Ø cm	V	W	Hz	
WWCM180E	60 u/h	sencilla / single	19	230	1.200	50/60	1

Resistente base de fundición. Placas con triple capa antiadherente. Indicadores de "encendido", "listo para cocer" y "listo para comer".

Durable cast-iron base. Plates with triple non-stick layer. "Power on", "ready to cook" and "ready to eat" indicators.

Résistant base en fonte. Plaques à triple couche anti-adhérente. Voyants "allumage", "prêt à cuire" et "prêt à manger".

Solides Gusseisengestell. Dreifach-antihafbeschichtete Platten. Signalleuchten: "ein", "kochbereit" und "gar/essfertig".

GELATO PANINI PRESS

Gofrera panini de helado / Ice cream panini press / Presse à panini Gelato / Waffeleisen Eis-Panini



REF	Cap. Max.	Tipo / Type	Ø cm	V	W	Hz	
WICSP180E	25 u/h	sencilla / single	10	230	1.200	50/60	1

Moldes con triple capa antiadherente, para retirar fácilmente los gofres y limpiar rápidamente el aparato.

Moulds with triple non-stick layer, to easily remove waffles and quickly clean the appliance.

Moules à triple couche antiadhésive, pour retirer facilement les gaufres et nettoyer rapidement l'appareil.

Backplatten mit dreifacher Antihafbeschichtung zum einfachen Lösen der Waffeln und zur schnellen Reinigung des Gerätes.



Ahorre hasta un 75% de energía* /
Save up to 75% energy /*
Économisez jusqu'à 75% d'énergie*
*Sparen Sie bis zu 75% Energie**

**TOSTADORAS CON
CORREA TRANSPORTADORA**

La convección forzada y las resistencias de cuarzo energéticamente eficientes brindan un tostado uniforme y rápido.

*La función en Stand by permite ahorrar un 75% de energía en el momento de baja demanda.

GRILLE-PAIN CONVOYEURS

La convection forcée et les résistances à quartz énergétiquement efficaces offrent un grillage uniforme et rapide.

*La fonction Stand by permet d'économiser 75% d'énergie aux moments de faible demande.

CONVEYOR TOASTERS

Forced convection and energy-efficient quartz resistors provide a uniform and fast toasting.

* The Stand by function saves 75% of energy during periods of low demand.

DURCHLAUFSTOASTER

Durch die erzwungene Konvektion und die energieeffizienten Quarzwiderstände kann eine gleichförmige und schnelle Bräunung erreicht werden.

* Die Stand-by-Funktion spart 75% Energie für Momente mit geringerer Nachfrage.

CT4-3600W Tostadora continua / Conveyor toaster / Grille - pain à convoyeur / Durchlaufstoaster

INOX - ST/STEEL
EDELSTAHL

REF	V	W	Hz	A	cm	H cm	
CT4-2301000	230	3.600	50/60	15	35 x 46	60	1



1.000

Rebanadas por hora /
Slices per hour /
Tranches heure /
Scheiben pro Stunde



Control de temperatura /
Temperature control /
Contrôle de la température /
Temperaturregler



Control de velocidad /
Speed control /
Contrôle de vitesse /
Geschwindigkeitsregler



Sistema stand-by /
Stand-by system /
Système stand-by /
Stand-by-System

**Resistencias de cuarzo
recambiables.**

Replaceable quartz
resistance.

Résistances à quartz
remplaçables.

Austauschbare
Quarzwiderstände.

Entregado sin clavija.

Delivered without plug
(stripped ends).
Livré sans prise.
Lieferung ohne Stecker.

CT4-2800W Tostadora continua / Conveyor toaster / Grille - pain à convoyeur / Durchlaufstoaster

INOX - ST/STEEL
EDELSTAHL

REF	V	W	Hz	A	cm	H cm	ENCH. PLUG	
CT4-23080002	230	2.800	50/60	12,7	35 x 36	60	EU	1
CT4-23080003	230	2.800	50/60	12,7	35 x 36	60	UK	1



450-800

Rebanadas por hora /
Slices per hour /
Tranches heure /
Scheiben pro Stunde



**Dispone de control de velocidad
y temperatura. Resistencias de
cuarzo recambiables.**

Avec contrôle de la vitesse et
température. Résistances à quartz
remplaçables.

Speed and temperature control.
Replaceable quartz resistance.

Geschwindigkeits- und
Temperatursteuerung.
Austauschbare Quarzwiderstände.

CT2-1500W Tostadora continua / Conveyor toaster / Grille - pain à convoyeur / Durchlaufstoaster

INOX - ST/STEEL
EDELSTAHL

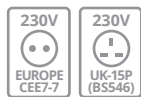

REF	V	W	Hz	A	cm	H cm	ENCH. PLUG	
CT2-23035002	230	1.500	50/60	12,5	35 x 36	41	EU	1
CT2-23035003	230	1.500	50/60	12,5	35 x 36	41	UK	1

Dispone de control de velocidad.
Resistencias de cuarzo recambiables.

Speed control.
Replaceable quartz resistance.

Avec contrôle de la vitesse.
Résistances à quartz remplaçables.

Geschwindigkeitssteuerung.
Austauschbare Quarzwiderstände.

350

Rebanadas por hora /
Slices per hour /
Tranches heure /
Scheiben pro Stunde

HORNO CINTA / CONVEYOR HEATING OVEN / FOUR CHAUFFANT À BANDE / FÖRDERBAND-AUFWÄRMOFEN

Diseñado para calentar cualquier tipo de snack y fundir queso de manera rápida y eficiente. Fabricado en acero inoxidable con un sistema de control de la velocidad variable y control de temperatura tanto por encima como por debajo de la cinta. Incluye bandeja para recoger migas. Su sistema de convección forzada y la posibilidad de regular la altura de la cinta, aseguran un tostado uniforme y la mayor eficiencia energética. Pueden remontarse dos unidades al mismo tiempo con un accesorio para ahorrar espacio.

Conçue pour préparer toute sorte de snack et faire fondre le fromage rapidement et efficacement. Fabriqué en acier inoxydable avec un système de contrôle de vitesse variable et un contrôle de température au-dessus comme en-dessous de la bande. Inclut bac de récupération de miettes. Son système de convection forcée et la possibilité de régler la hauteur de la bande, assurent un grillé uniforme et la meilleure efficacité énergétique. Il est possible de remonter deux unités à la fois avec un accessoire pour économiser de l'espace.

Designed to heat any type of snack and melt cheese quickly and efficiently. Made of stainless steel with a variable speed control system and temperature control both above and below the conveyor belt. It includes a crumb collection tray. It has a forced convection system and has the possibility of regulating the height of the belt, ensuring uniform toasting and the highest energy efficiency. Two units can be mounted one top of the other with a space-saving accessory.

Zum Erwärmen von Snacks aller Art und zum Schmelzen von Käse auf eine schnelle und effiziente Weise. Hergestellt aus rostfreiem Edelstahl mit Geschwindigkeits- und Temperatur-Steuervorrichtung sowohl oberhalb als auch unterhalb des Förderbands. Enthält Krümelauffangschale. Durch sein Umluftsystem und die Möglichkeit, die Bandhöhe einzustellen, werden eine gleichmäßige Bräunung und eine höhere Energieeffizienz sichergestellt. Um Platz zu sparen, können mit einem Zubehörteil zwei Geräte gleichzeitig montiert werden.

SO2-2800W Horno calentador de cinta / Conveyor heating oven / Four chauffant à bande / Förderband-Aufwärmofen

INOX - ST/STEEL
EDELSTAHL

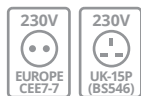

REF	V	W	Hz	A	cm	H cm	ENCH. PLUG	
SO2-23010.5	230	2.800	50	13,3	34 x 104	41	EU	1

26,7 cm

Ancho de cinta / Belt width /
Largeur de la bande / Bandbreite

3,8 - 7,6 cm

Altura entrada ajustable /
Adjustable entrance height /
Hauteur de l'entrée réglable /
Einstellbare Eintrittshöhe



SO2-3600W Horno calentador de cinta / Conveyor heating oven / Four chauffant à bande / Förderband-Aufwärmofen

INOX - ST/STEEL
EDELSTAHL



REF	V	W	Hz	A	cm	H cm	ENCH. PLUG	
SO2-23014.5	230	3.600	50	13,3	39 x 103,5	51	EU	1

36,8 cm

Ancho de cinta / Belt width /
Largeur de la bande / Bandbreite

3,8 - 7,6 cm

Altura entrada ajustable /
Adjustable entrance height /
Hauteur de l'entrée réglable /
Einstellbare Eintrittshöhe

MAQUINARIA /
EQUIPMENT /
EQUIPEMENT

**Tostadoras Estándar / Standard Toasters /
Toasteurs Standard / Toasters Standard**

P15042 Tostadora continua / Conveyor toaster / Toasteur convoyeur / Durchlauf toaster

INOX - ST/STEEL
EDELSTAHL

500
Rebanadas por hora /
Slices per hour /
Tranches heure /
Scheiben pro Stunde



REF	V	W	Hz	
P15.042	230	2.240	50/60	1

El color de las tostadas puede determinarse por la velocidad de la banda transportadora, así como por las resistencias superior e inferior que se controlan independientemente. El aparato está completamente aislado para que emita un calor mínimo a su alrededor. El interruptor encendido-apagado contempla la posición extra de standby. La longitud de la banda transportadora permite 2 hileras de tostadas (tipo 200) y 3 hileras (tipo 300).

La couleur du pain se détermine par la vitesse de la bande de transport ainsi que par les résistances contrôlées indépendamment. Les appareils sont isolés entièrement et n'émettent qu'une chaleur minimale à la température ambiante. Interrupteur marche-arrêt qui inclut le mode veille standby. La Largeur de la bande de transport permet 2 rangées de tranches, type 200 et 3 rangées, type 300.

Toast colour can be determined by conveyor speed as well as by independently controlled heating elements. Units are fully insulated to emit only minimal heat to surroundings. Main switch with extra standby position. The toasters can be used for bread as well as for buns. The toasting belt is suitable for 2 rows for toast, 200 type and 3 rows, 300 type.

Die Farbe der Toasts kann durch die Geschwindigkeit des Laufbands bestimmt werden, sowie durch die oberen als auch durch die unteren Heizelemente, welche unabhängig von einander kontrolliert werden können. Das Gerät ist komplett isoliert um die Umgebungstemperatur minimal zu beeinflussen. Ein/ Aus Schalter mit extra Standby Position. Die Breite des Laufbands erlaubt 2 Toastreihen (Typ 200) y 3 Toastreihen (Typ 300).

**CTS1000E Tostadora comercial de servicio pesado con transportador / Heavy - Duty Commercial Conveyor Toaster /
Grille - pain à convoyeur à usage intensif / Kommerzieller Hochleistungs- Durchlauf toaster**



450
Rebanadas por hora / Slices per hour /
Tranches heure / Scheiben pro Stunde



REF	V	W	A	Hz	
CTS1000E	230	2.700	11,25	50/60	1

Pre-calentamiento ultra rápido de 5 minutos.
Ancha abertura de 5 cm para tostar rebanadas gruesas y panecillos.
Modo de espera para ahorrar energía.
Transportador con velocidad variable.
Permite tostar por una sola cara.

Mise à température rapide (5 minutes).
Ouverture de 5 cm, pour les tranches épaisses.
Mode veille pour économiser de l'énergie.
Convoyeur à vitesse variable.
Permet de griller d'un seul côté.

Ultra-fast, 5-minute heat-up time.
Large 5 cm opening accommodates thick breads and bagels.
Energy-saving standby function
Conveyor speed control to suit all toasting preferences.
Allows toasting on one side only.

Ultra schnelle Vorerhitzung von 5 Minuten.
Öffnungshöhe von 5 cm zum Toasten von dicken Scheiben und Brötchen.
Energiesparende Standby Funktion.
Laufband mit regulierbarer Geschwindigkeit. Einseitiger Toaster.

P15038 Tostadora / Sandwich toaster / Toasteur / Sandwichtoaster

INOX - ST/STEEL
EDELSTAHL

80-100

Rebanadas por hora / Slices per hour /
Tranches heure / Scheiben pro Stunde

REF	V	W	Hz	
P15.038	230	1.700	50/60	1



Las resistencias se pueden controlar por separado. Con temporizador y bandeja limpieza recoge migas. 4 tubos de cuarzo.

Heating elements separately controllable. With timer, drip tray and 4 quartz heating elements.

Les résistances se contrôlent séparément. Avec minuterie, tiroir ramasse miettes et 4 tubes quartz.

Unabhängig steuerbare Hitzestäbe. Mit Timer und reinigbarer Krümelplatte, 4 Quarzrohre.

Se entregan con 3 pinzas para sandwich /
Delivered with 3 sandwich tongs /
Livrées avec 3 pinces à sandwich /
Lieferung mir 3 Sandwichzangen

P15039 Tostadora / Sandwich toaster / Toasteur / Sanwichtoaster

INOX - ST/STEEL
EDELSTAHL

120-130

Rebanadas por hora / Slices per hour /
Tranches heure / Scheiben pro Stunde

REF	V	W	Hz	
P15.039	230	3.000	50/60	1



2 niveles. Las resistencias funcionan por separado. Con temporizador, bandeja recoge migas. 9 tubos de cuarzo.

2 levels. Heating elements separately controllable. With timer, drip tray and 9 quartz heating elements.

2 niveaux. Les résistances se contrôlent séparément. Avec minuterie, tiroir ramasse miettes et 9 tubes quartz.

2 Ebenen. Unabhängig steuerbare Hitzestäbe. Mit Timer und reinigbarer Krümelplatte, 9 Quarzrohre.

Se entregan con 6 pinzas para sandwich /
Delivered with 6 sandwich tongs /
Livrées avec 6 pinces à sandwich /
Lieferung mir 6 Sandwichzangen

MAQUINARIA /
EQUIPMENT /
EQUIPMENT

Ver productos en / See products on / Voir produits en page / Siehe produkte in

P.
456

PINZA DE PAN DE MADERA /
WOODEN BREAD SPOON /
PINCE À PAIN EN BOIS /
HOLZBROTZANGE



IDEA!
Ideal para manipular las tostadas /
Ideal for handling toast /
Idéal pour manipuler le pain grillé /
Ideal zum Servieren von Toasts

P15040 / P15041 Tostadora / Toaster / Toasteur / Toaster



REF	Ranuras / Slots / Fentes / Schlitz	V	W	Hz	
P15.040	4	230	1.800	50/60	1
P15.041	6	230	2.500	50/60	1

Ref. P15.040

120

Rebanadas por hora / Slices per hour / Tranches heure / Scheiben pro Stunde



Fabricada en acero inoxidable. Con conmutador ahorro energía para decidir la cantidad de rebanadas a tostar. 2 ó 4 (ref.15040) 3 ó 6 (ref.15041). Con temporizador. Ranura: 2,5 x 14,5 x 14,5 cm.

All St/Steel construction. With energy-saving switch to decide how many slices to toast. 2 or 4 (ref.15040) 3 or 6 (ref.15041). With timer. Slot: 2,5 x 14,5 x 14,5 cm.

Habillage en acier inoxydable. Avec commutateur économiseur pour choisir le nombre de tranches à griller: 2 ou 4 (ref. 15040) 3 ou 6 (ref. 15041). Avec minuterie. Fente: 2,5 x 14,5 x 14,5 cm.

Hergestellt aus rostfreiem Stahl. Mit energiesparendem Schalter um die Anzahl der zu toastenden Scheiben zu bestimmen. 2 oder 4 (Art.Nr.15040) 3 oder 6 (Art.Nr.15041). Mit Timer. Schlitz: 2,5 x 14,5 x 14,5 cm.

Ref. P15.041



WCT708E Tostadora de servicio mediano de 4 rebanadas / 4 - Slice Medium - Duty Toaster / Grille - pain à usage moyen / 4 Scheiben Mittelleistungs Toaster



REF	Ranuras / Slots / Fentes / Schlitz	V	W	A	Hz	
WCT708E	4	230	1.800	7,8	50/60	1

225

Rebanadas por hora / Slices per hour / Tranches heure / Scheiben pro Stunde



3,5 x 13,5 x 13,5 cm

Ranura / Slot / Fente / Schlitz

Con expulsión automática / With pop up system / Avec éjection automatique / Automatischer Auswurf



Planchas de fundición.
Bandeja y recoge jugos.
Borde antisalpicaduras.
Luces piloto.
Termostato ajustable hasta 300 °C.

Plaque en fonte.
Tiroir de propreté.
Bordure anti projections haute.
Voyants lumineux.
Thermostat réglable jusqu'à 300 °C.

Cast iron griddle plates.
Large drip tray.
High turned-up spatter rim.
Indicator lights.
Adjustable thermostat to 300 °C.

Grillplatten aus Gusseisen.
Fettauffangsschale.
Seiten mit Antispritzschutz.
Kontrollleuchten.
Einstellbares Thermostat bis 300 °C.

Incluido en el precio / Included on the price /
Inclus dans le prix / Inklusivim Preis

Ref. P818.000



Ver productos en / See products on /
Voir produits en page / Siehe produktein

P.
121

MOLDE HUEVO SANDWICH CUADRADO /
SQUARED EGG MOULD /
MOULE À OEUF CARRÉ /
RECHTECKIGE SPIEGELEIERFORM



P15004 Grill de contacto "SOLO COMPACT" / "SOLO COMPACT" Contact grill /
Grill de contact "SOLOCOMPACT" / "SOLO COMPACT" Kontaktgrill

INOX - ST/STEEL

EDELSTAHL

18/10



Ranura arriba y abajo /
Upper and lower grooves /
Quadrillage en haut et en bas /
Schlitz oben und unten



REF	Superficie de cocción / Cooking surface / Surface de cuisson / Grillplattenfläche cm	V	W	Hz	
P15.004	22 x 23	230	1.800	50/60	1



Control de temperatura /
Temperature control
Contrôle de la température /
Temperaturregler



Bandeja recoge grasa /
Fat collection tray /
Bac de récupération de graisse /
Fettauffangsschale

P15005 Grill de contacto "SOLO GRANDE" /
"SOLO GRANDE" Contact grill /
P15006 Grill de contact "SOLO GRANDE" /
"SOLO GRANDE" Kontaktgrill

INOX - ST/STEEL

EDELSTAHL

18/10



Ranura arriba y abajo /
Upper and lower grooves /
Quadrillage en haut et en bas /
Schlitz oben und unten
P15.005

Ranura arriba /
Upper groove /
Quadrillage en haut /
Schlitz oben
P15.006



P15007 Grill de contacto "DUETTO COMPACT" /
"DUETTO COMPACT" Contact grill /
P15008 Grill de contact "DUETTOCOMPACT" /
"DUETTO COMPACT" Kontaktgrill

INOX - ST/STEEL

EDELSTAHL

18/10



Ranura arriba y abajo /
Upper and lower grooves /
Quadrillage en haut et en bas /
Schlitz oben und unten
P15.007

Ranura arriba /
Upper groove /
Quadrillage en haut /
Schlitz oben
P15.008



REF	Superficie de cocción / Cooking surface / Surface de cuisson / Grillplattenfläche cm	V	W	Hz	
P15.005	32 x 21	230	2.200	50/60	1
P15.006	32 x 21	230	2.200	50/60	1

REF	Superficie de cocción / Cooking surface / Surface de cuisson / Grillplattenfläche cm	V	W	Hz	
P15.007	47 x 23	230	3.600	50/60	1
P15.008	47 x 23	230	3.600	50/60	1



MAQUINARIA /
EQUIPMENT /
EQUIPMENT

BATIDORAS PLANETARIAS / MIXERS / MÉLANGEURS / MIXERS

Engranajes y ejes de acero de fundición permiten alargar la vida del producto y proporcionan un funcionamiento más silencioso/

Gears and shafts are made of heat-treated alloy steel for long life and quieter operation/

Engrenageset arbres en acier allié traité à la chaleur pour une longue durée et un fonctionnement plus silencieux/

Zahnräder und Wellen aus wärmebehandeltem legiertem Stahl gewährleisten eine lange Lebensdauer und einen leiseren Betrieb

Acción de batido elíptico /
Planetary mixing action /
Mélangeur planétaire /
Planetenrad-Misch-getriebe



Paro automático por sobre calentamiento /
Thermal overload protection automatically shuts off mixer to protect from damage /
Arrêt automatique par la surchauffe /
Wärmeüberlastschutz schaltet den Mixer zur Schadens-verhütung automatisch aus

Temporizador digital 30 minutos, con paro automático con señal acústica /
30 minute digital timer with automatic stop and audible shutoff signal /

Minuterie numérique (30 minutes) à arrêt automatique et signal d'arrêt sonore /
30-Minuten-Digitalzeituhr mit automatischem Stopp und akustischem Abschaltsignal

Velocidades de mezcla constantes independientemente del volumen /
Consistent mixing speeds regardless of volume/
Vitessesde mélange uniformes, quel que soit le volume /
Gleichmäßige, von der Menge unabhängige Mischgeschwindigkeiten

Protección Seguridad /
Safety guard /
Protecteur de sécurité /
Schutzblende

Construcción extra robusta /
Heavy-duty construction /
Construction robuste /
Stark belastbare Ausführung

Incluye / Comes with / Livré avec / Standardausstattung:

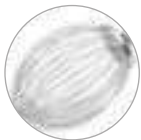

Batidor varilla /
Wire Wishk /
Fouet à fil /
Schlagbesen



Gancho para masa /
Dough hook /
Crochet de pâte /
Kneithaken

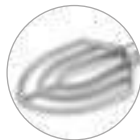

Espátula /
Spatula /
Spatule /
Schaber



Bol acero inoxidable /
S/Steel mixing bowl /
Bol mélangeur en acier inoxydable /
Edelstahl-Mischschüssel

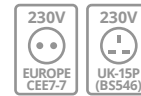

4075502 Amasadora sobre mesa / Countertop Mixers / Mélangeurs de comptoir / Arbeitsflächen-Mixer



1/3 HP / 250 W / 3 A

REF	Lts.	cm (W X D X H)	Velocidad / Speed / Vitesse / Geschwindigkeit	V	Enchufe / Plug / Prise / Stecker	
4075502	6,6	33,5 x 45 x 51,5	5	220-230	Europe	1
4075503	6,6	33,5 x 45 x 51,5	5	220-230	UK	1
4075602	9,5	33,5 x 45 x 54	5	220-230	Europe	1
4075603	9,5	33,5 x 45 x 54	5	220-230	UK	1



4075503

REF	Para / For / Pour / Für (Lts)		REF	Para / For / Pour / Für (Lts)	
Batidor varilla / Wire Wishk / Fouet à fil / Schlagbesen			Espátula / Spatula / Spatule / Schaber		
XMIX0705	6.6	1	XMIX0703	6.6	1
40762	9.5	1	40764	9.5	1
Gancho para masa / Dough hook / Crochet de pâte / Kneithaken			Bol acer / Mixing bowl / Bol mélangeur / Mischschüssel		
XMIX0704	6.6	1	XMIX0702	6.6	1
40763	9.5	1	40761	9.5	1

Panel de control digital para simplificar el cambio de velocidades mientras la unidad está funcionando

Panneau de commande numérique pour faciliter les changements de vitesse pendant le fonctionnement de l'appareil

Digital control panel to make easy speed shifts while unit is running.

Digitalbedienfeld ermöglicht einfache Drehzahländerungen bei laufendem Gerät

4075702 Amasadora de pié / Floor-Bench mixers /
Mélangeurs au sol-sur plan de travail / Boden-Tisch-Mixer

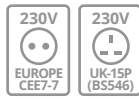

4075702

REF	Lts.	cm (W X D X H)	Velocidad / Speed / Vitesse / Geschwindigkeit	V	HP	W	A	Enchufe / Plug / Prise / Stecker	
4075702	19	52 x 52 x 91	3	220-230	0,5	370	4	Europe	1
4075703	19	52 x 52 x 91	3	220-230	0,5	370	4	UK	1
4075802	28	64 x 62 x 122	3	220-230	1,0	750	8	Europe	1
4075803	28	64 x 62 x 122	3	220-230	1,0	750	8	UK	1
4075902	38	68 x 68 x 120	3	220-230	1,5	1.120	11	Europe	1
4075903	38	68 x 68 x 120	3	220-230	1,5	1.120	11	UK	1

REF	Para / For / Pour / Für (Lts)		REF	Para / For / Pour / Für (Lts)	
Batidor varilla / Wire Wishk / Fouet à fil / Schlagbesen			Espátula / Spatula / Spatule / Schaber		
40766	19	1	40768	19	1
40770	28	1	40772	28	1
40774	38	1	40776	38	1
Gancho para masa / Dough hook / Crochet de pâte / Knehtaken			Bol acer / Mixing bowl / Bol mélangeur / Mischschüssel		
40767	19	1	40765	19	1
40771	28	1	40769	28	1
40775	38	1	40773	38	1

P15089 / P15090 / P15091 Cortadora eléctrica de fiambres / Electric slicing machine /
Trancher électrique / Elektrische Aufschnittmaschine



Cuerpo: aluminio pintado.
Body: painted aluminium.
Corps: aluminium peint.
Körper: Aluminiumbeschichtet.

REF	V	Hz	W	Ø Cuchilla / BlaDe Lame / Messer cm	Espesor corte / Slicer thickness Epaisseur de coupe / Schnittbreite mm	Dim cm	Kg	
P15.089	230	50	120	22	0-9	48 x 40 x 37	14,8	1
P15.090	230	50	150	25	0-9	48 x 40 x 37	16,0	1
P15.091	230	50	250	30	0-11	59 x 38 x 43	22,6	1

Ref. P15.090

Ø 25 cm
Cuchilla / Blade /
Lame / Messer



Ref. P15.091

Ø 30 cm
Cuchilla / Blade /
Lame / Messer



Ref. P15.089

Ø 22 cm
Cuchilla / Blade /
Lame / Messer



Ver productos en / See products on /
Voir produits en page / Siehe produktein

P.
137

GEL LUBRICANTE SANITARIO /
SANITARY GEL LUBRICANT /
GEL LUBRIFIANT SANITAIRE /
MEDIZINISCHES Gleitgel





Lleve a cabo cualquier tarea de mezclado/licuado con los brazos trituradores portátiles Waring Commercial. Desde el versátil modelo QuickStik hasta el modelo de servicio pesado de 1 HP Big Stix, estos brazos trituradores son herramientas básicas para las cocinas más atareadas de hoy. Con varillas de 17.75 a 53.5 cm, permiten procesar desde 11.5 hasta 200 litros a la vez. Las cuchillas multifunción de acero inoxidable garantizan un licuado homogéneo, y el cómodo mango ofrece mayor control. ¡Licue, bata, mezcle y haga purés sin esfuerzo gracias a Waring!

Power through any mixture with the portable handheld Waring Commercial Immersion Blenders. From the versatile QuikStik to the heavy-duty 1 HP Big Stix, these are essential tools for today's busy kitchens. The shaft sizes range from 17.75 cm to 53.5 cm with capacities from 11.5 to 200 liters. The all-purpose stainless steel blades ensure smooth, consistent blending, and the comfort grips keep the user in control. Blend, whisk, mix, purée and whip with Waring!

Mixez en toute facilité grâce aux mixeurs Waring Commercial. Du plus pratique (le QuikStik) au plus puissant (le Big Stix de 1 HP), ce sont des outils essentiels pour les cuisines modernes. Leurs pieds de 17,75 à 53,5 cm permettent de mixer 11,5 à 200 L à la fois. Leurs lames en acier inoxydable garantissent des résultats homogènes. Leurs poignées ergonomiques offrent un maximum de confort. Mixez, fouettez, mélangez et réduisez en purée sans effort grâce à Waring !

Leistungsstarkes Mixen und Verflüssigen mit den Stabmixern Waring Commercial. Von dem vielseitigen Modell QuikStik bis hin zum robusten 1 HP Big Stix sind diese Stabmixer heutzutage ein wesentliches Werkzeug der vielbeschäftigten modernen Küchen. Mit Stablängen von 17.75 bis 53.5 cm kann man von 11.5 bis 200 Liter auf einmal bearbeiten. Die Multifunktionsmesser aus rostfreiem Stahl garantieren ein homogenes Zerkleinern und die bequemen Griffe bieten eine gute Kontrolle. Verflüssigen, Mixen und Pürieren Sie mühelos mit Waring!

Brazo triturador de servicio pesado Big Stix / Heavy-Duty Big Stix / Bras mixeur à usage intensif Big Stix / Einarmiger Hochleistungsstabmixer Big Stix

Bloque motor universal adaptable a todos los brazos y batidores. Motor de servicio pesado de 1 HP (potencia de entrada máxima). Velocidad variable. 18 000 RPM a velocidad alta (1600 RPM con los batidores). Función de encendido continuo. Acoplamientos (bloque-motor y varilla) reemplazables por el usuario. Cómodo mango cubierto de caucho y empuñadura auxiliar, para mayor control y seguridad. Varilla de acero inoxidable sellada, removible y apta para lavavajillas.

Universal power pack fits all shafts and whisk attachments. 1 peak input HP heavy-duty motor. Variable speed operation. 18,000 RPM on high (1,600 for whipping paddles). Continuous ON feature. User-replaceable couplings on power pack and shaft. Rubberized comfort grip and second handle for safe and controlled operation. Completely sealed stainless steel shaft is easily removable and dishwasher safe.

Bloc-moteur universel adaptable à tous les pieds et fouets. Moteur haute performance de 1 HP (puissance d'entrée maximale). Vitesse variable. 18.000 tr/mn à haute vitesse (1 600 tr/mn avec les fouets). Marche continue. Accouplements (bloc-moteur et pied) faciles à changer. Poignée caoutchoutée et poignée auxiliaire, pour davantage de confort et de sécurité. Pied hermétique en acier inoxydable, amovible et compatible lave-vaisselle.

Universeller Motorblock geeignet für alle Stablängen und Halter. Hochleistungsmotor von 1 HP (max. Eingangsleistung). Variable Geschwindigkeit. Max. 18.000 U/min (1.600 U/min. Rührbesen). Funktion Dauerbetrieb. Durch Kopplung (Motorblock - Stab) vom Benutzer austauschbar. Bequemer Griff mit Kautschukbeschichtung und Hilfsgriff bieten eine höhere Kontrolle und Sicherheit. Stab aus versiegeltem rostfreiem Stahl, austauschbar und Spülmaschinen geeignet.



Sistema bloqueo para trabajar sin operador /
Locking system to work without operator /
Système de blocage pour fonctionnement sans opérateur /
Sperrvorrichtung für den Einsatz ohne Bediener /

Doble asa /
Double handle /
Double poignée /
Doppelgriff /

Velocidad regulable /
Adjustable speed /
Vitesse réglable /
Verstellbare Geschwindigkeit /

WSBPPCE **Bloque motor / Power Pack** **Bloc-moteur / Motorblock**

REF	W	Hz	
WSBPPCE	1 HP/ 750 W	50/60	1

WSB50ST WSB55ST WSB60ST WSB65ST WSB70ST



Varilla / Shaft / Pied / Stab

REF	Varilla extraíble / Removable Shaft / Pied amovible / Abnehmbarer Stab	Capacidad / Capacity / Capacité / Kapazität	
WSB50ST	30,5 cm	40 L	1
WSB55ST	35,5 cm	60 L	1
WSB60ST	40,5 cm	100 L	1
WSB65ST	45,5 cm	140 L	1
WSB70ST	53,5 cm	200 L	1

Triple sellado del brazo / Triple-sealed shaft /
Triple fixation du bras / Dreifach versiegelter Stab



WSBPPCE
+WSB50ST
30,5 cm / 40 L

WSBPPCE
+WSB55ST
35,5 cm / 60 L

WSBPPCE
+WSB60ST
40,5 cm / 100 L

WSBPPCE
+WSB65ST
45,5 cm / 140 L

WSBPPCE
+WSB70ST
53,5 cm / 200 L



INOX - ST/STEEL
EDELSTAHL

WSB2W

Accesorio batidor / Whisk Attachment /
Fouets / Rührbesen Zubehör

REF	L cm	
WSB2W	25,5	1

Caja de engranaje de fundición, para mejor desempeño.

Die-cast gears for optimal performance.

Engrenage en acier moulé, pour des performances optimales.

Gegossenes Getriebegehäuse für eine bessere Performenz.



LOW: 17.000 RPM
HIGH: 18.000 RPM



WSB40E

Brazo triturador de servicio mediano /
Quik Stik Plus / Medium-Duty Quik Stik Plus /
Bras mixeur Quick Stik Plus à usage moyen /
Stabmixer mittlerer Gebrauch Quik Stik Plus

REF	Hz	
WSB40E	50/60	1

Motor de servicio pesado de ½ HP, con 2 velocidades/370 W.
Varilla fija de 25.5 cm.
Capacidad de 23 litros .
230V, 50 Hz, 1.5 A.
Homologado CE y RoHS.

*½ HP, 2-speed.
heavy-duty motor/370 W.
25.5 cm fixed shaft.
23-liter capacity.
230 volts, 50 Hz, 1.5.
amps. CE, RoHS.*

Puissant moteur de ½HP, à deux vitesses/370 W.
Pied fixe de 25,5 cm.
Capacité de 23 litres.
230V, 50 Hz, 1,5A.
Homologué CEet RoHS.

*Ochleistungsmotor von ½ HP,
mit 2 Geschwindigkeiten /370
W. Fester Stab von 25.5 cm.
Bearbeitungsvermögen 23 Liter.
230 V, 50 Hz, 1,5 A, Zertifiziert mit CE
und RoHS.*



LOW: 14.500 RPM
HIGH: 15.000 RPM



WSB33XE

Brazo triturador de servicio ligero Quik Stik /
Light-Duty Quik Stik /
Bras mixeur Quick Stik à usage léger /
Stabmixer leichter Gebrauch Quik Stik

REF	Hz	
WSB33XE	50/60	1

Motor de alta eficacia, con dos velocidades.
Varilla fija de 17.75 cm.
Capacidad de 11.5 litros.
230V, 50 Hz, 0.4 A, 175 W.
Homologado CE y RoHS.

*2-speed high-efficiency motor.
17.75 cm fixed shaft.
11.5-liter capacity.
230 volts, 50 Hz, 0.4 amps,
175 W. CE, RoHS.*

Moteur hautement efficace à deux vitesses.
Pied fixe de 17,75 cm.
Capacité de 11,5 litres.
230V, 50 Hz, 0,4A, 175 W.
Homologué CEet RoHS.

*Motor mit hoher Leistung und zwei
Geschwindigkeiten und festem Stab von
17.75 cm Länge. Bearbeitungsvermögen
11.5 Liter. 230 V, 50 Hz, 0.4 A, 175 W.
Zertifiziert mit CE und RoHS*



Una batidora de vaso para cada necesidad / A Blender For Every Need /
Un blender pour tous les besoins / Ein Standmixer für jedes Bedürfnis



BLADE

TORQ

X POWER

Batidora de vaso para cócteles
Bar Blender
Blender de bar
Barcocktailstandmixer

Batidoras de vaso profesionales
NuBlend Commercial Blenders
Blenders professionnels NuBlend
NuBlend professioneller Standmixer

Torq Series

Batidoras de vaso de servicio pesado
Heavy Duty Blenders
Blenders haute puissance
Hochleistungsstandmixer

Batidoras de vaso de 4 L
4-Liter Food Blenders
Blenders de 4 L
4 Liter Standmixer

BEBIDAS POR DÍA / DRINKS PER DAY / BOISSONS- JOUR/ GETRÄNKE PRO TAG

1 - 25

25 - 49

50 - 74

75 +

100 +

USO Y SERVICIO / USAGE AND APPLICATION TYPE / UTILISATION/ GEBRAUCH UND EINSATZMÖGLICHKEIT

Preparación de bebidas Servicio ligero a mediano	Preparación de alimentos y bebidas Servicio ligero a mediano	Preparación de alimentos y bebidas Servicio mediano a pesado	Preparación de bebidas y alimentos Servicio pesado	Preparación de alimentos Servicio pesado
<i>Light to Medium Beverage Prep</i>	<i>Light to Medium Food and Beverage Prep</i>	<i>Medium to Heavy Food and Beverage Prep</i>	Heavy Food and Beverage Prep	<i>Heavy Food Prep</i>
Préparation de boissons Usage léger à moyen	Préparation de boissons et culinaire, usage léger et moyen	Préparation de boissons et préparation culinaire Usage moyen à intensif	Préparation de boissons et préparation culinaire Usage intensif	Préparation culinaire Usage intensif
<i>Zubereitung von Getränken</i> Gering- oder Mittelgebrauch	<i>Zubereitung von Lebensmittel und Getränken</i> Gering- oder Mittelgebrauch	<i>Zubereitung von Lebensmittel und Getränken</i> Mittel- und Vielgebrauch	<i>Zubereitung von Lebensmittel und Getränken</i> Vielgebrauch	<i>Zubereitung von Lebensmittel</i> Vielgebrauch

IDEAL PARA / GREAT FOR USE IN / TYPESDECOMMERCE/ IDEAL FÜR

Bares	Bares, restaurantes pequeños y heladerías	Bares, restaurantes y heladerías	Heladerías, cafeterías, restaurantes, bares, establecimientos de cuidado de la salud, escuelas, instituciones	Restaurantes grandes, establecimientos de cuidado de la salud, escuelas, instituciones
<i>Bars</i>	<i>Bars, Small Restaurants, Smoothie Shops</i>	<i>Bars, Restaurants, Smoothie Shops</i>	<i>Smoothie Shops, Coffee Shops, Restaurants, Bars, Healthcare, Schools, Institutions</i>	<i>Large Restaurants, Healthcare, Schools, Institutions</i>
<i>Bars</i>	<i>Bars, petits restaurants, commerces de jus de fruits frais</i>	<i>Bars, restaurants, commerces de jus de fruits frais</i>	<i>Bars/Commerces de jus de fruit, salons de thé, restaurants, centres de remise en forme, établissements scolaires ou médicaux, institutions</i>	<i>Restaurants, brasseries, établissements scolaires ou médicaux, institutions</i>
<i>Bars</i>	<i>Bars, kleine Restaurants und Eisdielen</i>	<i>Bars, Restaurants und Eisdielen</i>	<i>Eisdielen, Bsitros, Restaurants, Bars, Wellnesseinrichtungen, Schulen, Institute</i>	<i>Grosse Restaurants, Wellnesseinrichtungen, Schulen, Institute</i>

APLICACIONES RECOMENDADAS / RECOMMENDED APPLICATIONS / IDEÁL POUR LA PRÉPARATIONDE/ IDEAL FÜR DIE ZUBEREITUNG VON

Bebidas heladas, batidos de fruta, margaritas y mucho más	Cócteles helados, batidos de helado, salsas frías y calientes, aderezos y más	Margaritas, daiquiris, granitas, salsas, sopas y más	Batidos de fruta, bebidas de café helado, cócteles helados, salsas, aderezos, sopas, postres, aliños y mucho más	Aliños, salsas, aderezos, sopas y más
<i>Frozen Drinks, Smoothies, Margaritas and More</i>	<i>Frozen Cocktails, Ice Cream Drinks, Dips, Salsas, Sauces and More</i>	<i>Margaritas, Daiquiris, Granitas, Sauces, Soups and more</i>	<i>Fruit Smoothies, Iced Coffee Drinks, Frozen Cocktails, Salsas, Sauces, Soups, Desserts, Dressings and more</i>	<i>Dressings, Salsas, Sauces, Soups and More</i>
<i>Milkshakes, boissons glacées, cocktails, Margaritas, etc.</i>	<i>Boissons glacées, milkshakes, cocktails, sauces, etc.</i>	<i>Margaritas, Daiquiris, Granitas, sauces, soupes, etc.</i>	<i>Smoothies, café glacé, cocktails glacés, sauce, crèmes, soupes, desserts, vinaigrettes, etc.</i>	<i>Vinaigrettes, sauces, crèmes, soupes, etc.</i>
<i>Gefrorene Getränke, Fruchtcocktails, Margaritas und vieles mehr</i>	<i>Eiscocktails, Eishakes, kalte und heisse Sossen, Dressings und vieles mehr</i>	<i>Magaritas, Daiquiris, Granitas, Sossen, Suppen und vieles mehr</i>	<i>Fruchtcocktails, gefrorene Kaffegetränke, Eiscocktails, Sossen, Nachtisch, Dressings und vieles mehr</i>	<i>Dressing, Sossen, Suppen und vieles mehr</i>

MAQUINARIA /
EQUIPMENT /
EQUIPMENT



Las batidoras de vaso profesionales Waring Commercial son herramientas esenciales para cualquier bar o restaurante. Esta línea clásica siempre logra resultados profesionales, gracias a características profesionales: resistentes jarras de alta capacidad de acero inoxidable, copoliéster sin bisfenol-A o cristal; potentes motores de hasta 1120W y cuchillas de acero inoxidable que siempre logran resultados rápidos y homogéneos. ¡Pique hielo y prepare bebidas en tan sólo segundos con las potentes licuadoras profesionales Waring Commercial!

The staple in any bar or restaurant, the Waring Commercial Blender consistently delivers a professional blend. This classic product line offers a variety of sizes, styles and capacities in durable stainless, BPA-free copolyester, or glass containers. Powerful, professional motors with up to 1120W HP drive stainless steel cutting blades for quick, consistent results. Crush ice in seconds and make drinks instantly with the power of Waring Commercial!

Les blenders Waring Commercial sont les outils de base par excellence pour tout type de bar ou restaurant. Disponibles en plusieurs tailles et styles (acier inoxydable, copolyester sans BPA, verre), ces outils classiques sont équipés de puissants moteurs professionnels jusqu'à 1120W et de couteaux en acier inoxydable, pour des résultats rapides et homogènes. Broyez de la glace et préparez des boissons en quelques secondes grâce aux puissants bols mixeurs Waring Commercial!

Die professionellen Standmixer von Waring Commercial sind essentielle Werkzeuge für jede Bar oder Restaurant. Die klassische Produktlinie bietet immer professionelle Ergebnisse, dank seiner professionellen Eigenschaften: Resistente Behälter von grossem Fassungsvermögen aus rostfreiem Stahl, Glas oder Copolyester ohne Bisfenol-A (BPA); leistungsstarken Motoren von bis zu 1120W und messer aus rostfreiem Stahl, die immer für ein schnelles und homogenes Ergebnis sorgen. Zerkleinern Sie Eis und bereiten Sie Getränke in Sekundenschnelle mit den leistungsstarken Mixern von Waring Commercial!

BB340E

Batidora de vaso comercial Blade Series / Blade Series Commercial Blender / Mixeur à jarre commerciale Blade Series / Gewerblicher Standmixer Blade Series

BLADE



21.700 RPM - 3,6 A



25-49

Bebidas por día /
Drinks per day /
Boissons - jour /
Getränke pro tag



REF	V	W	Hz	
BB340E	220-240	1 HP / 750 W	50/60	1

Jarra copoliéster.
Controles electrónicos: Alto, Bajo,
Apagado y Pulso.
Con temporizador de cuenta
regresiva de 99 segundos.

Copolyester container.
High, Low, Off and Pulse electronic
controls.
With 99-second countdown timer.

Copolyester.
Contrôle électronique: Haut, Bas,
Arrêt et Pulse.
Avec minuteur de 99 secondes

Copolyester.
Elektronische Kontrolle: High, Low, Off
und Puls.
Mit 99 Sekunden Countdown Timer.

BB300E

Batidora de vaso comercial Blade Series / Blade Series Commercial Blender / Mixeur à jarre commerciale Blade Series / Gewerblicher Standmixer Blade Series

BLADE



21.700 RPM - 3,6 A



25-49

Bebidas por día /
Drinks per day /
Boissons - jour /
Getränke pro tag



REF	V	W	Hz	
BB300E	220-240	1 HP / 750 W	50/60	1

Jarra copoliéster.
Controles mecánicos: Alto, Bajo,
Apagado y Pulso.

Copolyester container.
High, Low, Off and Pulse toggle
switches.

Bol en copolyester.
Interrupteurs à bascule: Haut, Bas,
Arrêt et Pulse.

Behälter aus copolyester.
Mechanische Kontrolle: High, Low, Off
und Puls.

CAC132

Jarra / Container / Bol / Karaffen

REF	Lts	
CAC132	1,40	1

Apilable / Stackable / Empilable / Stapelbar



Compatible / Compatible /
Compatible / Kompatibel
BB340 - BB300

BB255E

Batidoras de vaso para cócteles básicas / Basic Bar Blenders / Blenders de bar / Basis Cocktail Mixer



21.000 RPM - 2,2 A



1-25

Bebidas por día /
Drinks per day /
Boissons - jour /
Getränke pro tag



REF	Lts	V	W	Hz	
BB255E	1,30	220-240	3/4 HP / 550 W	50/60	1

2 velocidades. Resistente cuchilla
de acero inoxidable de dos piezas.
Acoplamiento de goma reforzado
con metal y reemplazable por el
usuario. Jarra copoliéster.

2 speeds. Rugged, two-piece stainless
steel cutting blade. User-replaceable,
metal-reinforced rubber drive
coupling.
Copolyester container.

2 vitesses. Couteau 2 pièces robuste
et en acier inoxydable.
Bol en copolyester.

2 geschwindigkeiten. Zweiteilige
robuste Edelstahl Klinge
Behälter aus copolyester.

CAC134

Jarra / Container / Bol / Karaffen

REF	Lts	
CAC134	1,30	1



TORQ 2.0



**Tapa para alimentos/
líquidos calientes de vinilo
con tapón extraíble.**

*Vinyl lid for hot food/
beverage blending and
removable center cap
that locks into place or
can be removed to feed
ingredients while blending.*

Couvercle en vinyle pour
aliments/liquides chauds
avec bouchon doseur
amovible.

*Deckel für heiße
Lebensmittel/
Flüssigkeiten aus Vinyl
mit abnehmbaren
Verschlusskopf.*

**Jarra apilable transparente
de 1.4 L resistente, de
servicio pesado y de
calidad profesional. Diseño
único, para máxima
eficacia y
rendimiento.**

*1.4L clear-view stackable jar
- commercial grade, heavy-
duty and breakresistant.
Uniquely shaped for
maximum efficiency and
performance.*

Bol transparent empilable de
1,4 L résistant, à usage
intensif et de qualité
professionnelle.
Spécialement conçu pour
maximiser l'efficacité et le
rendement.

*1,4 l stapelbarer transparenter
Behälter, resistent gegen
häufigen Gebrauch und mit
professioneller Qualität.
Einzigartiges Design für
höchste Effizienz und Leistung.*

**Resistente cuchilla de
acero inoxidable con
robustas piezas de
acero, hechas para durar
pero reemplazables por
el usuario. Su forma
"agresiva" ha sido
especialmente diseñada
para este vaso y es capaz
de picar hielo al instante.**

*Heavy-duty stainless steel
blade with solid steel blending
assembly - built to last but
completely user-replaceable.
This aggressive blade design is
configured specifically for this
jar and is engineered to crush
ice instantly.*

Couteau en acier inoxydable
avec pièces en acier massif
construits pour durer mais
remplaçables par l'utilisateur.
Couteau "agressif"
spécialement conçu pour le
bol et capable de broyer la
glace instantanément.

*Resistente Messer aus
rostfreiem Stahl mit robusten
Stahlteilen, gemacht für
Langlebigkeit aber auch durch
den Benutzer austauschbar.
Die "aggressive" Form ist
speziell für den Behälter
disign und ist in der Lage Eis
sehr schnell zu crashen.*

**Controles HI/LO/STOP/
PULSE con temporizador
de cuenta progresiva de
60 segundos (modelos
sin temporizador
también disponibles) -
Las batidoras de vaso
Margarita Madness®
Elite vienen equipadas
con tres tipos de
controles: mecánicos,
electrónicos y
electrónicos con
temporizador.**

*HI/LO/STOP/PULSE controls
with 60-second countdown
timer (non-timer versions
available) - the Margarita
Madness Elite Series
Blenders feature three
control styles - a simple
toggle switch control,
electronic keypad and
electronic keypad with
60-second countdown
timer.*

Commandes HAUT/BAS/
ARRÊT et PULSE avec
minuteur de 60 secondes
(modèles sans minuteur
également disponibles).
Les bols mixeurs de la
série Margarita Madness
Elite sont disponibles en
trois styles : commandes
mécaniques, commandes
électroniques ou
commandes électroniques
avec minuteur de 60
secondes.

*HI/LO/STOP/PULSE Kontrolle
mit 60 Sekunden Countdown.
(Modelle ohne Timerfunktion
auch erhältlich) - Die Mixer
Margarita Madness® Elite
sind ausgestattet mit 3
verschiedenen Kontrollen:
Mechanisch, Elektronisch
oder Elektronisch mit
Timerfunktion.*

**Base resistente y
compacta con potente
motor de 2 HP/1490
vatios y cojinete
amortiguador removible
para facilitar la limpieza.**

*Heavy-duty base with
powerful 2 HP, 1490W
motor - this amazing
combination makes for big
power yet small foot print
and includes a removable
jar pad for easy cleanup.*

Boitier résistant et compact
avec puissant moteur
de 2 HP/1490W et coussin
amortisseur amovible
pour faciliter le nettoyage.

*Resistente und kompakte
Basis mit einem
leistungsstarkem
Motor von 2 HP, 1490W
und mit abnehmbarer
Stossdämpfungseinheit zur
einfachen Reinigung*

TORQ 2.0

2 HP / 1490 W
24.500 - 27.000 RPM - 6,1 A

1,4 Lts
Jarra.
Container.
Bol.
Karaffen.



Capaz de preparar 3 margaritas de 470 ml en 8 segundos o menos.

Blend three 470 ml margaritas in 8 seconds or less.

Permet de préparer 3 margaritas de 470 ml en 8 secondes ou moins.

Fähig 3 margaritas von 470 ml in 8 oder weniger Sekunden herzustellen

50-74

Bebidas por día /

Drinks per day /

Boissons - jour /

Getränke pro tag



TBB145E

Batidora de vaso Torq / Torq blender /
Blender Torq / Mixer der Torq



REF	Lts	V	W	Hz	
TBB145E	1,40	220-240	2 HP / 1.400 W	50/60	1

Controles mecánicos clásicos.

Classic toggle switch.

Interrupteur à bascule.

Klassischer.



TBB160E

Batidora de vaso Torq / Torq blender /
Blender Torq / Mixer der Torq



REF	Lts	V	W	Hz	
TBB160E	1,40	220-240	2 HP / 1.400 W	50/60	1

Controles electrónicos con temporizador de cuenta regresiva de 60 segundos.

Electronic keypad with 60-second countdown timer.

Contrôle électronique avec minuteur de 60 secondes.

Elektronische Kontrolle mit 60 Sekunden Countdown Timer.

CAC139

Jarra / Container / Bol / Karaffen

REF	Lts	
CAC139	1,40	1



Cojinete amortiguado de una sola pieza extraíble y apto para lavavajillas.
One-piece dishwasher-safe removable jar pad.

Coussin amortisseur d'une pièce, amovible et compatible lave-vaisselle.
Stosdämpfereinheit aus einem Stück.

MX1500XTXSEE



45.000 RPM

+75
Bebidas por día /
Drinks per day /
Boissons - jour /
Getränke pro tag



REF	Lts	W	Hz	
MX1500XTXSEE	2,00	3,5 HP / 2.600 W	50	1

4 botones programables para preparar bebidas
Pantalla LCD con retroiluminación azul, para mayor comodidad
Contador de bebidas con total y total diario
Velocidad variable
Función de pulso con control de velocidad programable
Con recinto de insonorización.

4 reprogrammable beverage stations
LCD display with blue backlight for easy viewing and program selection
Daily and total drink counter display
Adjustable speed controls
Dual PULSE feature with reprogrammable speed control.
With sound enclosure.

Quatre boutons programmables pour la préparation des boissons
Écran numérique avec rétro-éclairage
Compteur qui affiche le total de préparations du jour et le grand total
Vitesse variable
Double fonction PULSE avec vitesse programmable
Avec système d'insonorisation.

Station mit 4 programmierbaren Knöpfen zur Getränkezubereitung.
LCD Display mit blauer Beleuchtung für die einfache Handhabung.
Gesamt- und Tageseinheitenzähler.
Variable Geschwindigkeit
PULSE Funktion mit programmierbarer Geschwindigkeit.
Gehäuse mit Geräuschisolierung.



Batidora de vaso de alta potencia con velocidad variable /
Hi-Power Variable Speed Blender /

Blender haute puissance à vitesse variable /
Hochleistungsstandmixer mit variabler Geschwindigkeit

MX1200XTXEE



20.000 RPM

+75
Bebidas por día /
Drinks per day /
Boissons - jour /
Getränke pro tag



REF	Lts	W	Hz	
MX1200XTXEE	2,00	3,5 HP / 2.600 W	50	1

Cojinete amortiguador de una pieza, extraíble y apto para lavavajillas.
Jarras y recintos de insonorización disponibles.

One-piece dishwasher-safe removable jar pad. All units available with the following jars and sound enclosures.

Coussin amortisseur d'une pièce, amovible et compatible lave-vaisselle. Bols et systèmes d'insonorisation disponibles.

Stosdämpfereinheit aus einem Stück, austauschbar und spülmaschinengeeignet. Behälter und Gehäuse mit Geräuschisolierung erhältlich.



Ideal para amasar masa de pan, montar claras, licuar sopas y batidos y mucho más.

Ideal for whipped egg whites, soups, smoothies and everything in between.

Idéal pour pain aux blancs d'œufs en neige, soupes, milk-shakes et plus encore.

Ideal für durchzuführen, Durchkneten von Teigmassen, Eiweiss schlagen, Suppen verflüssigen, Mischen und vieles mehr.

**Batidora de vaso de alta potencia con velocidad variable /
Hi-Power Variable Speed Blender /**

MX1100XTXSEE

Blender haute puissance à vitesse variable /
Hochleistungsstandmixer mit variabler Geschwindigkeit



45.000 RPM

+75
Bebidas por día /
Drinks per day /
Boissons - jour /
Getränke pro tag



REF	Lts	W	
MX1100XTXSEE	2,00	3,5 HP / 2.600 W	1

Controles electrónicos fáciles de limpiar con funciones de ENCENDIDO/APAGADO, ALTO, BAJO, PAUSA y PULSO. Temporizador electrónico de cuenta regresiva de 30 segundos. Con recinto insonorización.

Easy-to-clean electronic membrane keypad with simple ON/OFF, HIGH, LOW, STOP and PULSE controls. 30-second electronic countdown timer. With sound enclosure.

Contrôle électronique facile à nettoyer avec boutons MARCHÉ/ARRÊT, HAUT, BAS, PAUSE et PULSE. Minuteur électronique de 30 secondes. Avec système d'insonorisation.

Elektronische Kontrolle einfach zu reinigen mit Funktionen ON/OFF, HIGH, LOW, STOP und PULSE. Elektronischer Timer mit 30 Sekunden Countdown Funktion. Gehäuse mit Geräuschisolierung



MX1000XTXEE

Batidora de vaso de alta potencia con velocidad variable / Hi-Power Variable Speed Blender /
Blender haute puissance à vitesse variable / Hochleistungsstandmixer mit variabler Geschwindigkeit



30.000 RPM

+75
Bebidas por día /
Drinks per day /
Boissons - jour /
Getränke pro tag



REF	Lts	W	
MX1000XTXEE	2,00	3,5 HP / 2.600 W	1

Sencillos controles mecánicos: ALTO/BAJO/APAGADO y PULSO.

Simple HIGH, LOW, OFF and PULSE paddle switches.

Interrupteurs à bascule HAUT/BAS/ARRÊT et PULSE.

Einfache mechanische Kontrolle: HIGH, LOW, OFF und PULSE.



ADAPTABLES A / ADJUSTABLES TO / ADAPTABLE À / PASSEND ZU:



CAC95I

REF	L	
CAC95I	2	1

Jarra de copoliéster.
Copolyester jar.
Bol en copolyester.
Behälter aus Copolyester.



CAC93XI

REF	L	
CAC93XI	1,4	1

Jarra de copoliéster.
Copolyester jar.
Bol en copolyester.
Behälter aus Copolyester.



MAQUINARIA /
EQUIPMENT /
EQUIPMENT

521035 / 521030 Batidora helado / Mix-in blenders / Blenders mixeurs / Eis-Shakemschine

0-3000 RPM

REF	cm	H cm	W	Kg	
521035	19 x 20,5	62	560	7,9	1
521030	19 x 20,5	62	560	7,9	1



521035



521030

Clavija / Plug / Tige / Stecker:
SCHUKO 55272
UK 55271

Se vende por separado /
Sold separately /
Vendu séparément /
Separat erhältlich



- Ventosas de fijación en la base.
- Control de dial (521035) o control de velocidad variable operado con el pie (521030). Deja tus manos libres para una mezcla rápida y fácil.
- Protección anti salpicaduras prácticamente irrompible que mantiene el área de trabajo limpia.
- Esquinas interiores curvadas que facilitan la limpieza.
- Ventilación forzada de aire para aumentar la vida útil del motor y del cojinete.
- Cuerto estanco fabricado en acero inoxidable.
- El motor de velocidad variable ofrece versatilidad ideal para batidos con helados.
- Bottom-mounted stay-in-place suction cups.
- Dial Control (521035) or Foot-Operated (521030) variable-speed control leaves your hands free for quick and easy mix-in blending.
- Virtually unbreakable lexan splatter guard keeps work area neat and slides off easily for clean up.
- Curved inside corners and easy-to-clean cup-saver mixing head.
- Forced air ventilation for long bearing and motor life.
- Attractive stainless steel cabinet.
- Variable-speed blender motor offers versatility and control.
- The versatile blender also doubles to make standard shakes, smoothies, freezes, and sodas.
- Ventouses de fixation au bas de la machine.
- Commande via molette (521035) ou commande au pied (521030) à vitesse variable de façon à avoir les mains libres pour un mélange facile et rapide.
- Pare-éclaboussures en lexan pratiquement incassable, garde la zone de travail propre et se démonte facilement pour le nettoyage.
- Coins intérieurs incurvés et tête de mélange facile à nettoyer.
- Ventilation forcée pour une longue durée de vie des roulements et des moteurs.
- Corps en acier inoxydable élégant.
- Le moteur à vitesse variable du mixeur offre polyvalence et contrôle.
- Le mélangeur polyvalent permet également de réaliser des milk-shakes des smoothies, des freezes et des sodas.
- Feste, bodenmontierte Saugnäpfe.
- Drehzahlregelung per Wählscheibensteuerung (521035) oder Fußsteuerung lässt (521030) die Hände frei und gestattet schnelles und einfaches Mixen.
- Ein Spritzschutz aus praktisch unzerbrechlichem Lexan hält den Arbeitsbereich sauber und lässt sich zum Reinigen einfach entfernen.
- Ein Spritzschutz aus praktisch unzerbrechlichem Lexan hält den Arbeitsbereich sauber und lässt sich zum Reinigen einfach entfernen.
- Gerundete Innenkanten und einfach zu reinigender Mixerkopf, der Näpfe spart.
- forcierte Lüftung für lange Lebensdauer von Lager und Motor.
- Attraktives Edelstahlgehäuse.
- Mixeromotor mit variabler Drehzahl für Vielseitigkeit und individuelle Steuerung.
- Der vielseitige Mixer kann gleichzeitig für normale Shakes, Smoothies, Freezes und Sodas verwendet werden.

6001X Licuadora de servicio pesado / Heavy-Duty Juice Extractor /
Centrifugeuse à usage intensif / HochleistungsEntsafter

3600 RPM - 1,4 A



REF	V	W	Hz	
6001X	230	330	50/60	1



Cuchilla flotante de acero inoxidable, para extraer el zumo y eliminar la pulpa rápidamente.

Stainless steel blade speeds up juice flow with faster distribution of pulp.

Lame flottante en acier inoxydable qui extrait le jus rapidement, réduisant ainsi la quantité de pulpe.

Messer aus rostfreiem Stahl, zum schnellen Entsaften und Fruchtfleiscentfernung.

8,00 - 10,00 L

Preparación máxima horaria / Maximum hourly preparation /
Préparation maximum horaire / MaximiertestündlicheZubereitung

WKS800E Afilador de cuchillos comercial / Commercial Knife Sharpener
Aiguiseur électrique commercial / KommerziellerMesserschärfer



REF	V	W	Hz	A	
WKS800E	230	25	50/60	0,1	1



Dos ruedas de afilar (fino/grosso) y una rueda de pulir.
Afila a un ángulo de 18-22°, el ángulo recomendado por los fabricantes de cuchillos.
La rueda de pulir gira en dirección opuesta para remover las asperezas en el filo del cuchillo de manera óptima y lograr un pulido más efectivo

Two grinding wheels (fine/coarse), one stropping wheel.
Grinds at 18-22° angles — optimum angles recommended by knife manufacturers.
Stropping wheel also operates in reverse direction, allowing for a more efficient removal of burrs and polishing of the blade.

Deux meules d'affûtage (grains fins/grossiers) et une meule de polissage.
Aiguise à un angle de 18-22°, l'angle recommandé par les fabricants de couteaux.
La meule de polissage tourne dans les deux sens, pour un meilleur affilage.

Zwei Schärfräder (fein/grob) und ein Polierrad.
Schärfwinkel 18-22°, von den Messerhersteller empfohlen.
Das Polierrad dreht sich in der entgegengesetzten Richtung, um die Schärfrückstände optimal zu entfernen und um eine effiziente Polierung zu erreichen.

MAQUINARIA /
EQUIPMENT /
EQUIPMENT

Guía de selección: calentadores y retermalizadores /

Rethermalizer and Warmer: selection guide /

Guide de sélection: appareils de remise à température et appareils de maintien à température /

Rethermalisierer und Speisenwärmer im Vergleich Auswahlübersicht

**RETERMALIZADORES / RETHERMALIZERS /
 AP. DE REMISE EN TEMPÉRATURE/ RETHERMALISIERER**

Diseñado para calentar y mantener alimentos a la temperatura deseada. Incluso permite calentar comidas salidas directamente del refrigerador en menos de 90 minutos.

Designed to take a container of prepared food from a chilled state to a temperature in less than 90 minutes.

Conçu pour chauffer un aliment préparé congelé jusqu'à la température de service en moins de 90 minutes.

Ausgelegt, um einen Behälter mit gekühlten zubereiteten Speisen in weniger als 90 Minuten auf Temperatur zu bringen.

Aplicación
Retermaliza alimentos fríos.
Mantiene calientes los alimentos.

Application
Retherm Chilled Food. Hold Heated Food.

Application
 Remise à température des aliments réfrigérés. Tenir les aliments chauffés.

Anwendung
Aufwärmen von gekühlten Speisen. Halten der Temperatur von aufgewärmten Speisen.

	INDUCTION 3D	RETRO	CAYENNE	CAYENNE
				
Calentadores y retermalizadores / Warmer and rethermalizer / Ap. de remise à température et ap. de maintien à température / Rethermalisierer und Speisenwärmer im Vergleich	✓	✓	✓	✓
Solo calentador / Warmer only / Chauffant seulement / Nur speisenwärmer				
Potencia (W) / Power (W) / Puissance (W) / Leistung (W)	800	800	800	1000
Calentamiento a través de contacto directo / Direct contact heating system / Système de chauffage par contact direct / Direktkontakt Erhitzungssystem			✓	✓
Agua / Water / Eau / Wasser		✓	✓	✓
Luz indicadora nivel de agua bajo / Low water light / Contrôle du niveau d'eau par voyant lumineux / Wassertiefstandsanzeige			✓	✓
Inducción / Induction / Induction / Induktion	✓			
Capacidad (L) / Capacity (L) / Capacité (L) / Fassungsvermögen (L)	6,6 - 10,4	6,6 - 10,4	6,6 - 10,4	20
Control de Temperatura / Temperature control / Contrôle de température / Temperaturüberwachung	✓	✓	✓	✓

CALENTADORES / WARMERS / CHAUD / SPEISEWÄRMER

Diseñado para mantener calientes las comidas preparadas.

Designed to hold heated prepared foods.

Conçu pour contenir des aliments préparés et chauffés.

Aplicación
Mantiene calientes los alimentos.

Application
Hold Heated Food.

Application
Tenir les aliments chauffés.

OLLA ELÉCTRICA / SOUP KETTLE / MARMITECHAUD / ELEKTRISCHER BUFFERTOP	BAÑO MARÍA / BAIN MARIE / BAIN MARIE / WASSERBAD	CHAFING DISH
		
✓	✓	✓
400	1200	
✓	✓	✓
10	20	9
✓	✓	

✓ INCLUIDO / INCLUDED /
INCLUS / INBEGRIFFEN

MAQUINARIA /
EQUIPMENT /
EQUIPMENT

INDUCTION 3D

REHERMALIZER

MIRAGE®



Inducción 3D de bajo consumo, sin necesidad de utilizar agua. Tiempo de rethermalización rápido (50-60 min). Los alimentos no necesitan ser precalentados. Directamente del congelador al Retermalizador. Menú de preselección y regulador de temperatura preciso.

Low power, 3D induction, without the need to use water. Rapid heating time (50-60 min). Food does not need to be pre-heated. Directly from the freezer to the Rethermalizer. Pre-selection menu and precise temperature regulator.

Induction 3D basse consommation, sans nécessité d'utiliser de l'eau. Temps de rethermalisation rapide (50-60 min). Les aliments n'ont pas besoin d'être préchauffés. Directement du congélateur au rethermalisateur. Menu de présélection et régulateur de température précis.

3D-Induktion mit niedrigem Stromverbrauch, Verwendung von Wasser nicht erforderlich. Schnelle Rethermalisierungszeit (50 - 60 Min.). Die Speisen brauchen nicht vorgewärmt werden. Direkt vom Tiefkühler in den Rethermalisierer. Vorauswahl-Menü und Regler für präzise Temperatureinstellung.

747-7411 Retermalizador de inducción Mirage® / *Mirage® Induction Rethermalizers /*
Appareil de remise en température à induction Mirage® / *Mirage® InduktionsRethermalisierer*

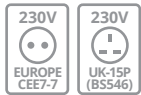

REF	L	cm (Ø x H)	Prof. cm	Volt. CA/ AC	W	A	Ench. Plug	Hz	☐
NEW 7470210	6,6	30,3 x 34,2	17,6	230	800	3,5	EU	50/60	1
7470240	6,6	30,3 x 34,2	17,6	230	800	3,5	EU	50/60	1
7470310	6,6	30,3 x 34,2	17,6	230	800	3,5	UK	50/60	1
7470340	6,6	30,3 x 34,2	17,6	230	800	3,5	UK	50/60	1
74110210	10,4	35,3 x 34,2	17,6	230	800	3,5	EU	50/60	1
74110240	10,4	35,3 x 34,2	17,6	230	800	3,5	EU	50/60	1
74110310	10,4	35,3 x 34,2	17,6	230	800	3,5	UK	50/60	1
74110340	10,4	35,3 x 34,2	17,6	230	800	3,5	UK	50/60	1

■ Natural / *Natural / Nature / Naturfarben*
■ Rojo / *Red / Rouge / Rot*



747D-7411D Retermalizador de inducción Mirage® encastrable / *Mirage® Drop-In Induction /*
Appareil de remise en température à induction encastrable Mirage® / *Mirage® Einbau-Induktionswärmer*

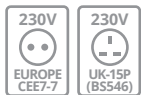

1,8 m



1,5 m



REF	L	cm (Ø x H)	Prof. cm	Volt. CA/ AC	W	A	Ench. Plug	Hz	☐
74702D	6,6	30,3 x 31,3	17,6	230	800	3,5	EU	50/60	1
74703D	6,6	30,3 x 31,3	17,6	230	800	3,5	UK	50/60	1
741102D	10,4	35,3 x 31,3	17,6	230	800	3,5	EU	50/60	1
741103D	10,4	35,3 x 31,3	17,6	230	800	3,5	UK	50/60	1

Drop-In / *Drop-In / Encast. / Einbau*

88184 Cubetas aptas para Retermalizadores Mirage® 3D /
Induction ready inserts for Mirage® 3D Induction Rethermalizers /
Conteneur pour Appareil de remise de température Mirage® 3D /
Behälter geeignet für Mirage® 3D Rethermalizer



REF	L	Para abertura Fits opening cm	Prof. cm	☐
88184	6,6	21,6	20,8	6
88204	10,4	26,7	20,8	6

47488 Tapa con visagra y orificio / *Lid with hinge / Couvercle / Deckel*



REF	Para / For	Ø cm	☐
47488	78184 / 88184	24,0	6
47490	78204 / 88204	28,7	6

Retro



El Retermalizador Retro calienta los productos con agua, como cualquier baño maría. Calienta la comida fría hasta una temperatura deseada en menos de 90 minutos.

El elemento de base cerámica garantiza un arranque rápido y un rendimiento uniforme. El cuerpo exterior no se calienta durante el uso del Retermalizador. Los cacillos se venden por separado.

Retro Rethermalizer unit heats products with water, like any bain marie. Heats food from a chilled state to a temperature in less than 90 minutes.

Ceramic base element ensures a fast start-up and consistent performance. Heavy duty exterior body ensures the unit remains cool to the touch while operating. Ladles sold separately.

L'unité de remise à la température Retro chauffe les produits avec de l'eau, comme tout bain marie. Chauffe les aliments d'un état réfrigéré à une température en moins de 90 minutes.

L'élément de base en céramique garantit un démarrage rapide et une performance homogène. L'extérieur reste frais au toucher tout en fonctionnant.

Der Retro Rethermalisierer erhitzt Speisen mit Wasser wie im Wasserbad. Er erhitzt gekühlte Speisen in weniger als 90 Minuten.

Keramik-Grundelement garantiert ein schnelles Aufwärmen beim Einschalten und eine gleichmäßige Leistung. Strapazierbare Ummantelung gewährleistet, dass das Gerät sich während des Betriebs kalt anfühlt.

7217 Retermalizadores Estilo Retro / Retro Stock Pot Kettle Rethermalizers /
 Marmite de remise en température Rétro / Retro-Suppenkessel-Rethermalisierer

Retro CE

-  **Natural /**
Natural /
Naturel /
Naturfarben
-  **Rojo /**
Red /
Rouge /
Rot
-  **Blanco perla /**
Blanc cassé /
Pearl white /
Perlweiß
-  **Negro /**
Black /
Noir /
Schwarz



REF	L	VOLT. CA/ AC	W	A	ENCH. PLUG	Hz	
7217810	6,6	230	1400	6,1	EU	50/60	1
7217910	6,6	230	1400	6,1	UK	50/60	1
7217850	6,6	230	1400	6,1	EU	50/60	1
7217950	6,6	230	1400	6,1	UK	50/60	1
7217855	6,6	230	1400	6,1	EU	50/60	1
7217955	6,6	230	1400	6,1	UK	50/60	1
7217860	6,6	230	1400	6,1	EU	50/60	1
7217960	6,6	230	1400	6,1	UK	50/60	1
7217310	10,4	230	1400	6,1	EU	50/60	1
7217410	10,4	230	1400	6,1	UK	50/60	1
7217350	10,4	230	1400	6,1	EU	50/60	1
7217450	10,4	230	1400	6,1	UK	50/60	1
7217355	10,4	230	1400	6,1	EU	50/60	1
7217455	10,4	230	1400	6,1	UK	50/60	1
7217360	10,4	230	1400	6,1	EU	50/60	1
7217460	10,4	230	1400	6,1	UK	50/60	1

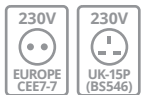

4980 Cacillos ErgoGrip™ de una sola pieza Kool-Touch® / One-Piece Ergo Grip™ Ladles with Kool-Touch® Handles /
 Louches Ergo Grip™ monobloc avec manche Kool-Touch® / Einteilige Ergo Grip™ Schöpflöffel mit Kool-Touch® Griffen



REF	ml	BOL / BOWL Ø cm	TOTAL cm	*cm	
4980422	118,3	7,9	33,3	27,6	6
4980622	177,4	8,6	33,6	27,6	6

*Largo desde el fondo del porcionador hasta el gancho del asa /
 *Length from bowl bottom to bend in handle /
 *Longueur du fond du bol à la courbure dans le manche /
 *Länge von der Unterseite der Höhlung bis zur Krümmung im Griff

Construcción de una sola pieza en acero inoxidable.
Asas revestidas de plástico que resisten el calor hasta 82 °C.

One-piece construction. Stainless steel. Plastic-coated handles are heat resistant to 82 °C.

Construction monobloc Inox.
 Manches plastifiés résistant à 82 °C.

Einteilige Ausführung. Präzise Schöpfteilabmessungen. Kunststoffbeschichtete Griffe sind bis 82 °C hitzebeständig.

46527 Tapa con visagra y orificio / Lid with hinge / Couvercle / Deckel

Retro CE



REF	Ø cm	
46527	24,0	6



BAÑO MARÍA / BAIN MARIES / BAIN-MARIE / WASSERBAD

Borde superior diseñado para evitar goteos y drenar la humedad.

Upper rim designed to prevent drips and to drain off the moisture.

Bordure supérieure conçue pour éviter l'égouttement et drainer l'humidité.

Der obere Rand ist darauf ausgelegt, Tropfenbildung zu verhindern und Feuchtigkeit abzuleiten.

Calentador con cúpula usa hasta un 25% menos de energía. La superficie antiadherente evita la acumulación de comida, facilitando la limpieza y prolongando la vida útil. Resistencia incrustada que alarga la vida útil y ayuda a difundir mejor el calor. Concentra la energía dentro del recipiente; produce vapor rápidamente.

Dome Heater. Uses up to 25% less energy. Non-stick surface prevents scale build-up for easy cleaning and longer operating life. Cast-in heating element for longer service life and greater energy transfer. Concentrates energy into the well - producing steam quickly.

Élément chauffant avec dôme qui utilise jusqu'à 25 % d'énergie en moins. La surface anti-adhésive empêche l'accumulation de dépôts calcaires pour faciliter le nettoyage et prolonger la durée de vie. Élément chauffant moulé pour prolonger la durée de service et augmenter le transfert d'énergie. Concentre l'énergie dans le compartiment ; produit rapidement de la vapeur.

Haubenheizung Verbraucht bis zu 25 % weniger Energie. Antihaftoberfläche verhindert Kalkablagerungen, vereinfacht das Reinigen u. gewährleistet eine längere Nutzungsdauer. Eingegossenes Heizelement stellt längere Nutzungsdauer und besseren Energietransfer sicher. Konzentriert die Energie in der Wanne für eine schnelle Dampferzeugung.

Termostato de tubo capilar, suministra energía solamente cuando es necesario, para alcanzar la temperatura deseada.

Capillary tube thermostat, provides energy only when it is required to reach the desired temperature.

Thermostat à tube capillaire, il fournit de l'énergie que lorsque c'est nécessaire pour atteindre la température souhaitée.

Ein Thermostat mit Kapillarrohr liefert Energie nur bei Bedarf, um die gewünschte Temperatur zu erreichen.

**Pies antideslizantes / Non-skid Feet /
Pieds antidérapants / Rutschsichere Standfüße**

Cuerpo de resina reforzada con fibra termofijada auto aislante. Máxima eficiencia energética. Fácil de limpiar.

Thermoset Fiber-Reinforced Resin Well Selfinsulating. Maximum energy efficiency. Easy to clean.

Compartiment en résine thermodurcie renforcée Isotherme. Rendement énergétique maximal. Nettoyage facile.

Faserverstärkte Duroplast-Wanne Selbstisolierend. Maximale Energieeffizienz. Einfach zu reinigen.

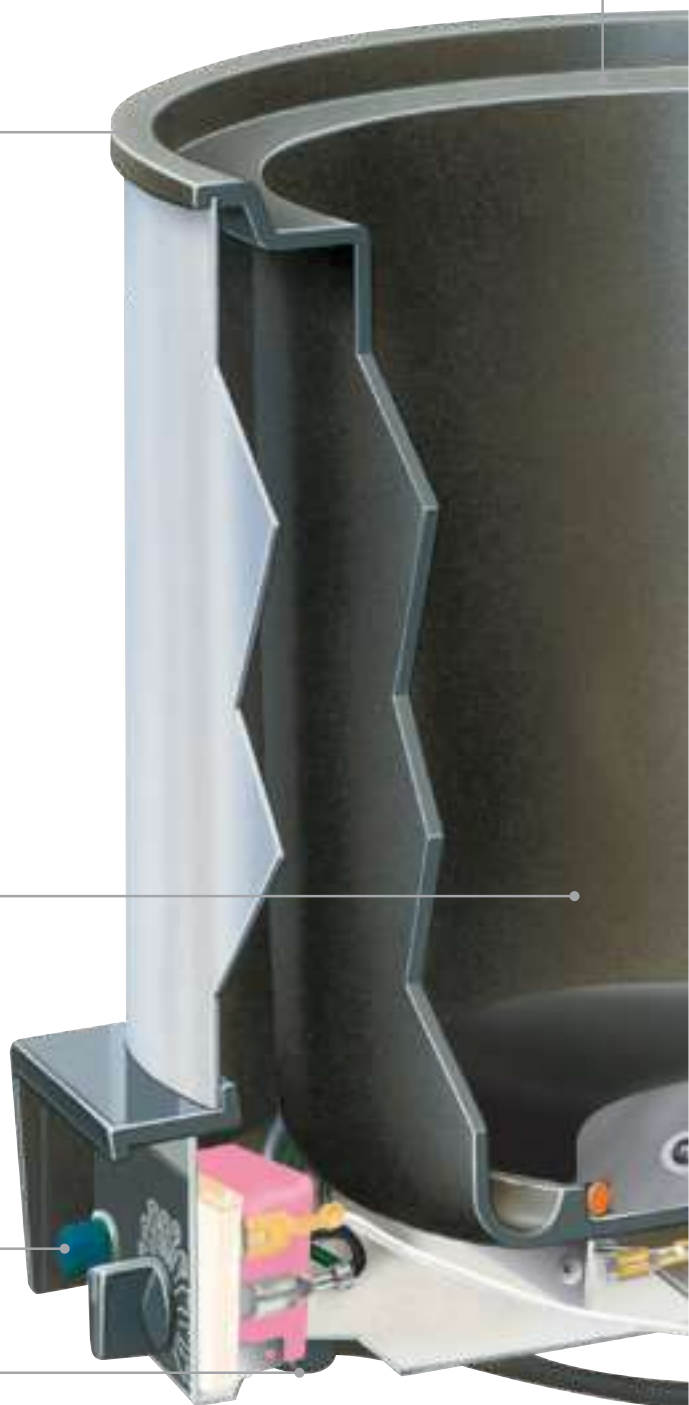

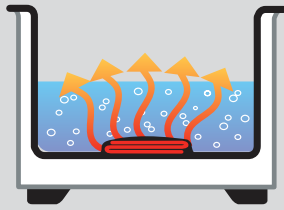

SIN VENTILACIONES
NO VENTS
SANS VENTILATION
KEINE ENTLÜFTUNGSÖFFNUNGEN



ALTA EFICIENCIA
HIGH EFFICIENCY
TRÈS ÉCOÉNERGÉTIQUE
HOHE EFFIZIENZ

SISTEMA DE CALENTAMIENTO DE CONTACTO DIRECTO / DIRECT CONTACT HEATING SYSTEM /
SYSTÈME DE CHAUFFAGE PAR CONTACT DIRECT / DIREKTKONTAKT-HEIZSYSTEM

La última palabra en rendimiento y eficiencia / The ultimate in performance and efficiency /
Performance et efficacité maximales / Ultimative Leistung und Effizienz

La resistencia está en contacto directo con el agua, transfiriendo el calor de una forma más eficiente. Esto se combina con el exclusivo cuerpo de resina reforzada, permitiendo un máximo aislamiento y máxima eficiencia energética. No necesita ventilación.

L'élément chauffant est en contact direct avec l'eau afin de permettre un transfert de la chaleur le plus efficace possible. De plus, le compartiment exclusif de Vollrath en résine thermodurcie renforcée offre une isolation supérieure rendant possible un rendement écoénergétique maximum. La conservation de chaleur est telle qu'il est inutile d'utiliser des éventails.

The heating element is in direct contact with the water for the most efficient heat transfer possible. This is coupled with Vollrath's exclusive Thermoset fiber-reinforced resin well, which provides superior insulation for maximum energy efficiency. So much heat is saved that there is no need for vents.

Das Heizelement befindet sich in direktem Kontakt mit dem Wasser und gewährleistet dadurch einen möglichst effizienten Wärmetransfer. In Verbindung mit Vollraths exklusiver, faserverstärkter Duroplast-Wanne ist für eine hervorragende Isolierung und damit eine maximale Energieeffizienz gesorgt. Es wird so viel Wärme gespart, dass keine Entlüftungsöffnungen notwendig sind.



Mayor capacidad de agua reducen los costos de mano de obra. Mejoran la calidad de la comida manteniendo el máximo calor húmedo.

Increased Water Capacity. Reduce labor costs. Improve food quality by maintaining maximum moist heat.

Capacité d'eau supérieure ayant pour conséquence une diminution des frais de main-d'oeuvre Amélioration de la qualité des aliments grâce au maintien d'un maximal de chaleur humide.

Erhöhtes Wasservolumen Arbeitskosten werden gesenkt. Durch Aufrechterhaltung eines Maximums an feuchter Wärme wird die Speisenqualität verbessert.

Exterior más fresco concentra el calor dentro del receptáculo, no en la superficie exterior ni en el reborde.

Cooler Exterior Concentrates heat inside the well, not to the outside surface and rim.

Extérieur plus frais qui concentre la chaleur à l'intérieur du compartiment et non sur la surface extérieure ou sur le rebord.

Kühlere Außenausführung Konzentriert die Wärme in der Wanne, nicht aber an den Außenflächen oder am Rand.

Cable eléctrico con salida inferior se adapta a la ubicación de la toma de corriente para una instalación segura. Permite controlar la ubicación en 360°. Largo estándar del cable de 183 cm.

Low positioning of electrical cord outlet adapts to the location of the power socket for safe installation. Allows the location to be controlled 360°. Standard cable length of 183 cm.

Câble d'alimentation muni d'une sortie située à la base S'adapte à la prise de courant pour une installation sûre. Permet le positionnement des commandes à 360 degrés. Câble d'une longueur standard de 183 cm.

Unten aus dem Gerät austretendes Netzkabel lässt sich der Steckdosenposition anpassen und ermöglicht so eine sichere Installation Ermöglicht eine 360-Grad Platzierung des Steuerteils. 183 cm langes Standardkabel.

CAYENNE®



72522 Olla Retermalizadora Cayenne® Heat'N'Serve / Cayenne® Heat'N'Serve Rethermalizer /
Ap. de remise en temp. Heat 'N Serve ronds Cayenne® / Runde Cayenne® Heat 'N Serve-Rethermalisierer

CE 800 W - 3,5 A
230 V

REF	cm (Ø x H)	L	V	W	ENCH. PLUG	
72522	32,0 x 24,5	10,4	230	800	EU	1



HS-11

Con recipiente interior y tapa con visagra /
With inset, hinged cover /
Avec conteneur et couvercle /
Mit Einsatz, Scharnierdeckel.

78204 Recipiente interior / Insert container /
Conteneur pour appareil de remise en température Heat 'N Serveronds Cayenne® / Einsatzbehälter

CE

REF	PARA / FOR	Ø cm	AL cm	L	
78204	72522	28,7	20,8	10,4	6



*Cubeta no apta para Inducción /
*Not induction-ready insert /
*Conteneur non Induction /
*Behälter nicht für Induktion geeignet.

47488 / 47490 Tapa con visagra y orificio / Lid with hinge / Couvercle / Deckel

CE

REF	PARA / FOR	Ø cm	
47488	78184 / 88184	24,0	6
47490	78204 / 88204	28,7	6



Retermalizador Cayenne® Heat'N'Serve 1/1 Gastronorm /
Rethermalizer Cayenne® Heat'N'Serve full size /

Appareils de remise en temp. Cayenne® Heat'N Serve 1/1 Gastronorme /
Cayenne® Heat'N Serve-Rethermalisierer in Standardgröße

72630 / 72550

CE 1.000 W - 4,3 A
 230 V

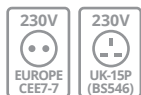

REF	PROFUNDIDAD WELL DEPTH cm	ENCH. PLUG	
72630	16,8	EU	1
72550	16,8	UK	1

Recipiente de resina reforzada con fibra termofijada aislante. Máxima eficiencia energética. Control de termostato /

Thermoset fiber reinforced well — self-insulating with maximum energy efficiency. Capillary Tube Thermostat Control /

Compartiment en résine thermodurcie renforcée – isotherme pour un rendement énergétique maximal. Thermostat à tube capillaire /

Faserverstärkte Duroplastwanne – selbstisolierend und maximale Energieeffizienz. Kapillarrohr-Thermostatregelung.

Baño maría 1/1 Gastronorm / Baño maría 1/1 Gastronorm con grifo drenaje /

Bain-marie 1/1 Gastronorm / Bain-marie 1/1 Gastronorm with drain valve /

Bain-marie 1/1 Gastronorme / Bain-marie 1/1 Gastronorm avec robinet de drainage /

Wasserbad 1/1 Gastronorm / Wasserbad 1/1 Gastronorm mit Ablasshahn

P15020

CE +30 °C
 +90 °C



REF	TIPO / TYPE	V	W	Hz	
P15020	A	230	1.200	50/60	1

Sin cubetas /
Without bags /
 Sans bacs /
 Ohne Behälter

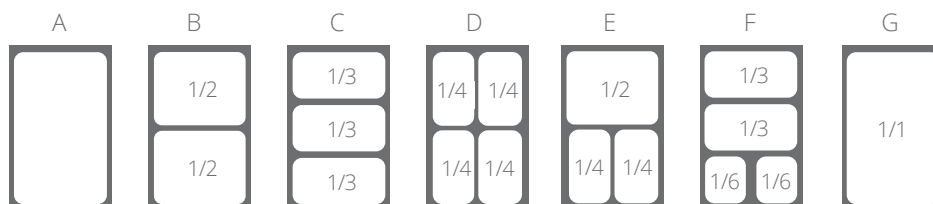

Max H 100 mm

P910008 Olla eléctrica para buffet / *Soup kettle* / Marmite buffet chaud / *Elektrischer Buffettopf*



Cuerpo de aluminio con baño epoxy.

External aluminium body with epoxy coating.

Corps en aluminium laque epoxy.

Aluminiumkörper mit Epoxybeschichtung.

REF	mm	L	
P910.008	345 x 360	10,0	1

Termostato regulador de temperatura. Resistencia 400 W, 1,9 amperios, 230 V monofase, 50/60 Hz. Tapa de acero inox. Cuba interior de acero inox. con capacidad para 10 litros.

Thermostat to regulate the temperature. Resistance 400 W, 1,9 amperes, 230 V single phase, 50/60 Hz. St/Steel lid. Inside pool St/Steel, 10 lts. capacity.

Thermostat pour le réglage de la température. Résistance 400 W, 1,9 ampères, 230 V monophasée, 50/60 Hz. Couvercle en acier inox. Cuve intérieure en acier inox. capacité 10 lts.

Temperaturkontrolle. Kotrolleuchten. Deckel Thermostat regulierbar Heizelement 400W, 1,9 A, 230V, 50/60 Hz. Edelstahldeckel. Innenbehälter aus Edelstahl mit Fassungsvermögen von 10 Liter.

P688130 Envasadora al vacío / *Vacuum sealer* / Machine sous vide / *Vakuuiergerät*



REF	V	W	Hz	Kg	
P688.130	230	200	50	7,5	1



Envasadora al vacío compacta CATERCHEF.

Los tiempos de conservación de los alimentos al vacío son mucho mayores.

Los microorganismos no se desarrollan ante la ausencia de oxígeno.

Puede ahorrar tiempo al cocinar en exceso y poder conservarlo en perfectas condiciones para un posterior uso.

- 400mm de banda de soldadura
- Función de vacío para cubetas
- Función marinado / Líquidos
- Función vacío parcial
- 20 L/min bomba vacío
- Posibilidad de usar solo como selladora de bolsas

CATERCHEF compact vacuum sealer.

Food sealed under vacu-um can be preserved for much longer periods.

With the absence of oxygen, micro-organisms do not develop.

You can save time by cooking more than you need and keeping the excess in perfect condi-tion for later use.

- 400mm sealing width
- Vacuum function for table pans
- Marinated / Liquids function
- Partial vacuum function
- 20 L/min vacuum pump
- Possibility of using as bag sealer only

Machine sous vide com-pacte CATERCHEF.

Les durées de conserva-tion des aliments sous vide sont largement supérieures.

Les microorganismes ne se développent pas en raison de l'absence d'oxygène.

Vous pouvez gagner du temps en cuisinant en grande quantité que vous pouvez conserver dans de parfaites condi-tions pour une consom-mation ultérieure.

- Bande de soudure de 400 mm
- Fonction sous vide pour bacs
- Fonction marinade / Liquides
- Fonction sous vide partiel
- 20 L/min pompe à vide
- Peut s'utiliser comme scelleuse de sachets

Kompaktes CATERCHEF Vakuuiergerät.

Die Konservierungszei-ten für vakuuimierte Lebensmittel sind viel länger.

Durch den fehlenden Sauerstoff können sich keine Mikroorganismen entwickeln.

Sie können sich die Zeit eines übermäßigen Einkochens sparen und Speisen für einen späte-ren Gebrauch in ein-wandfreiem Zustand konservieren.

- 400 mm Schweißnaht
- Vakuuierfunktion für Behälter
- Marinierfunktion / Flüssigkeiten
- Teilvakuu-Funktion
- 20 l/min Vakuumpum-pe
- Kann nur zur Beutel-versiegelung benutzt werden

P688133 / P688134 Bolsas vacío / *Vacuum bags* / Sachets sous vide / *Vakuuierbeutel*



REF	L m	W cm	
P688.133	6	30	1
P688.134	6	40	1

P688265 Lámpara mantenedora de comida caliente / Heat shade /
Abat - jour pour lampe chauffante / Wärmelampe



REF		Ø cm	V	W	Hz	
P688.265	Inox / St/Steel / Edelstahl	23	230	250	50/60	1
P688.266	Cobre / Copper / Cuivre / Kupfer	23	230	250	50/60	1

Bombilla no incluida.
Bulb not included.
Ampoule non comprise.
Glühbirne nicht inklusive.

Cable extensible hasta 180 cm.
Cable with rise and fall mechanism upto 180 cm.
Avec cable extensible jusqu'à 180 cm.
Auseinanderziehbares Kabel bis 180 cm.

P688045 Lámpara mantenedora de comida caliente / Heat shade /
Abat - jour pour lampe chauffante / Wärmelampe



REF	Ø cm	V	W	Hz	
P688.045	23	230	250	50/60	4

Aluminio. Con interruptor. Se entrega sin bombilla. Cable extensible hasta 180 cm.
Aluminium with on/off switch. Delivered without bulb. Cable with rise and fall mechanism upto 180 cm.

Aluminium avec interrupteur. Livraison sans ampoule. Avec cable extensible jusqu'à 180 cm.
Aluminium. Mit Schalter. Lieferung ohne Birne. Auseinanderziehbares Kabel bis 180 cm.

P15029 / P15030 Lámpara mantenedora de comida caliente / Heat shade with lamp /
Abat - jour pour lampe chauffante infra-rouge / Wärmelampe



REF	Ø cm	V	W	Hz	
P15.029	23	230	250	50/60	1
P15.030	23	230	250	50/60	1

Cable extensible
Rise&fall cable
Cable extensible
Festes Kabel

Se entrega con lámpara roja
Delivered with red bulb
Livraison avec ampoule rouge
Lieferung mit roter Lampe

Aluminio o cobre. Con interruptor. Se pone en funcionamiento rápidamente y proporciona un calor penetrante sin solidificar la superficie de las salsas. Fácil de instalar. Se entrega con lámpara (250 W max). Versión con cable de mecanismo extensible (máx. 140 cm).
Aluminium or copper. With on/off switch. It gives instant direct heat. Provides a penetrating heat without congealing surfaces, gravies, etc. Simple to install. Delivered with bulb (250 W max). Cable with rise and fall mechanism (max. 140 cm).

Aluminium ou cuivre. Avec interrupteur. Mise en service rapide. Chaleur pénétrante sans coaguler la surface des sauces, etc. Facile à installer. Livraison avec ampoule (250 W max). Avec cable extensible (max. 140 cm).
Aluminium oder Kupfer. Mit Schalter. Schnelles Einschalten und verteilt eine durchdringende Wärme ohne die Oberfläche der Sossen zu verbrennen. Einfache Installation. Lieferung mit Birne (250 W max). Mit ausziehbarem Kabel (máx. 140 cm).

P15033 / P15034 Bombilla / Bulb only / Ampoule seule / Ersatzbirnen



REF	Color / Colour / Couleur / Farbe	W	
P15.033	rojo / red / rouge / Rot	175	1
P710.205	rojo / red / rouge / Rot	250	1
P15.034	blanco / white / blanc / Weiss	175	1
P710.206	blanco / white / blanc / Weiss	250	1

MAQUINARIA /
EQUIPMENT /
EQUIPMENT

P15031 / P15032 Lámpara mantenedora de comida caliente / Heat shade with lamp /
Abat - jour pour lampe chauffante infra - rouge / Wärmelampe

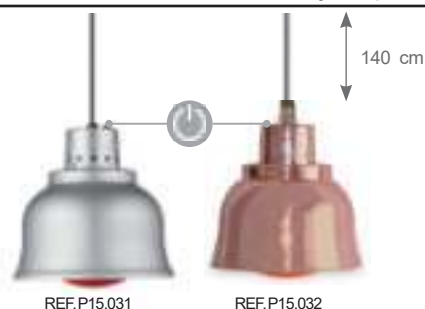

REF	Ø cm	V	W	Hz	
P15.031	23	230	250	50/60	1
P15.032	23	230	250	50/60	1

Cable fijo
Fixed cable
Cable fixe
Festes Kabel

250 W
Se entrega con bombilla roja.
Delivered with red bulb.
Livraison avec ampoule rouge.
Lieferung mit roter Lampe.

Aluminio o cobre.
Aluminium or copper.
Aluminium ou cuivre.
Aluminium oder Kupfer.

P688260 Lámpara mantenedora de comida caliente con mármol / Heat shade with marble /
Abat - jour pour lampe chauffante avec marbre / Wärmelampe mit marmor



REF		cm	H cm	V	W	Hz	
P688.260	Inox / St/Steel / Edelstahl	50 x 45	70	230	250	50/60	1
P688.261	Cobre / Copper / Cuivre / Kupfer	50 x 45	70	230	250	50/60	1

Bombilla no incluida.
Bulb not included.
Ampoule non comprise.
Glühbirne nicht inklusive.

P688250 Lámpara mantenedora de comida caliente / Heat shade /
Abat - jour pour lampe chauffante / Wärmelampe



REF		Ø cm	H cm	V	W	Hz	
P688.250	Inox / St/Steel / Edelstahl	24	70	230	250	50/60	1
P688.251	Cobre / Copper / Cuivre / Kupfer	24	70	230	250	50/60	1

Bombilla no incluida.
Bulb not included.
Ampoule non comprise.
Glühbirne nicht inklusive.

P508015 Lámpara mantenimiento comida caliente con soporte mesa / Heat shade with table support /
Lampe chauffante avec support / Wärmelampe mit Tischständer



REF	cm	V	W	Hz	
P508.015	22 x 22 x 65	230	250	50/60	1

Lámpara adaptada para mantener caliente todos platos. Estructura compuesta de lámpara infrarojos con base en acero inoxidable. Bombilla roja (250 W) incluida en el precio.

Appliance adapted to heat and keep warm snacks and ready meals. Structure is composed by an infrared lamp with a stainless steel base. Delivered with red bulb (250 W).

Lampe adaptée pour maintenir au chaud tous vos plats. Structure composée par lampe infrarouge avec base en inoxydable. Livrée avec ampoule rouge (250 W).

Lampe geeignet zum Warmhalten von allen Speisen. Struktur zusammengesetzt aus Infrarotbirne mit Gehäuse aus rostfreien Stahl. Rote Birne (250 W) im Preis inklusive.

ESTACIÓN BUFFET TRINCHANTE /
CONTOURED CARVING STATION /
STATION DE DÉCOUPAGE CONCAVE /
GEWELLTE TRANCHIERSTATION



2 x 175 W (Ref. P15033 / P15034)

Lámparas calentadoras dobles.
Dual heat lamps.
Deux lampes chauffantes.
Zwei Heizlampen.

Pantallas de aluminio para disipar el calor /
Spun aluminum shades for heat dissipation /
Abat-jour en aluminium repoussé pour
dissiper la chaleur /
Schirme aus gedrehtem Aluminium zur
Wärmeabfuhr.

Protección contra aliento con vidrio
templado transparente /
Clear tempered glass customer breath guard /
Pare-haleineen verre trempé transparent /
Durchsichtiger Kundenatemschutz aus
gehärtetem Glas

Marco de acero cromado altamente
resistente /
Heavy-duty steel frame, chrome-plated /
Cadre en acier chromé extra-robuste /
Strapazierfähiger Stahlrahmen, verchromt.

Piés antideslizantes que ofrecen una
mayor estabilidad /
Rubber feet provide stability and protect tabletop /
Les pieds en caoutchouc stabilisent et protègent la table /
GummifüÙe sorgen für Stabilität und Schutz der Tischfläche

Atractiva estación trinchante (para
carnes) con lámparas calentadoras.
Interruptor iluminado de
encendido/apagado en la base.

Station de découpage attrayante
disposant de lampes pour plus de
chaleur durant le service. Interrupteur
lumineux de marche/arrêt sur la base.

Attractive Carving Station with lamps
for additional heat while serving.
On/off lighted switch on base.

Attraktive Tranchierstation mit Lampen
für zusätzliche Wärme beim Servieren.
Ein/Aus-Schalter an der Basis.



Base y parte superior elegantes con
superficie lisa /

Stylish solid surface base & top /
Surface pleine esthétique (base et
dessus) /

Oberflächen, Schneidfläche und Oberteil
sind elegant und solide ausgeführt

Incluye tabla de corte, apta para
Certificación NSF /

Knife-friendly, dishwasher safe NSF
Certified cutting board included /

Planche à découper certifiée NSF incluse;
apte pour le lave-vaisselle /

Messerfreundliches, spülmaschinenfestes
Schneidbrett mit NSF Zertifizierung
inbegriffen.

La base empotrada canaliza los líquidos hacia una cubeta
para goteo retirable /

Recessed base channels liquids into removable drip pan /

La base renfoncée conduit les liquides dans un plateau
ramasse-gouttes /

Eingesenkter Boden leitet Säfte in entnehmbare Abtropfwanne ab

4667 Estación buffet trinchante / Contoured Carving Station /
Station de découpage concave / Gewellte Tranchierstation



Cable / Cord / Cordon / Kabel
L: 1,8 m.



REF	mm	VOLT. CA/ AC	ENCH. PLUG	Hz	
46671	610 x 559 x 686	230	EU	50/60	1
46672	610 x 559 x 686	230	UK	50/60	1

Bombilla de infrarrojos / Infrared bulb /
Ampoule infrarouge / Infrarot-Lampe

Incluye 2 bombillas de infrarrojos
2 Infrared bulb included
Inclus 2 ampoules infrarouges
Inclusive 2 infrarot-Lamp

P15.033

P15073 Placa caliente / Heating plate /
P15074 Plaque chauffante / Heizplatte



(gastronorm 1/1)



Control de temperatura /
Temperature control /
Contrôle de la température /
Temperaturregler

Fabricada en acero inoxidable 18/10. Termostato regulable hasta 75 °C.
Con interruptor central y piloto de control.

18/10 St/Steel. Adjustable thermostat up to 75 °C. With on / off switch and
indicator light.

Habillado en inox 18/10. Termostato réglable jusqu'à 75 °C. Interrupteur
central et voyant de contrôle.

Hergestellt aus Edelstahl 18/10. Thermostat regulierbar bis 75 °C. Mit zentralem
Schalter und Kontrollleuchten.

REF	mm	V	W	Hz	
P15.073	600 x 400	230	600	50/60	1
P15.074	530 x 325	230	600	50/60	1

Elemento eléctrico universal para chafing dish /
Universal electric chafer heater /
Résistance électrique pour chafers /
Universelle Rechaud-Elektroheizung

46110

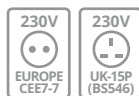

Dimensiones compatibles con el orificio para combustible estándar.
Sized to fit standard fuel opening.
Dimensions compatibles avec l'orifice pour combustible standard.
Abmessungen sind kompatibel mit den Öffnungen für Standardbenzin.

REF	Para / For	V	W	A	Ench. Plug	
46110	EU	230	120/230	1.0	EU	1
46115	UK	230	120/230	1.0	UK	1

Elemento eléctrico para chafing dish /
Electric heating unit for chafing dish /
Corps de chauffe pour chafing dish /
Elektrisches Element für chafing dish

P950000



Para / For /
Pour / Für:
P379.065
P387.065

REF	W	
P950.000	240	1

P15096 Fuente Fondue chocolate /
Chocolate fountain /
P15097 Fontaine à chocolat /
Schokoladenbrunnen

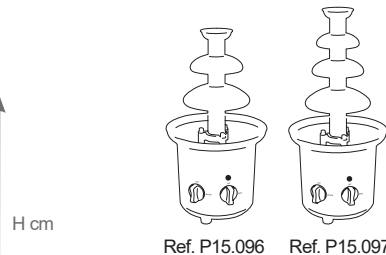

Ref. P15.096 Ref. P15.097

Cuerpo y partes de acero inoxidable. Incorpora un regulador de temperatura. Muy fácil de desmontar y limpiar. Pie regulador para apoyo estable.

St/Steel body and parts. Temperature and control. Easy to clean. Adjustable foot for a stable standing.

Corps et composants en acier inoxydable. Régulateur température. Très facile à nettoyer. Pied de régulation pour un appui stable.

Gehäuse und Teile aus rostfreiem Stahl. Eingebauter Temperaturregler. Einfach auseinander zu nehmen und zu reinigen. Regulierbarer Fuss für einen stabilen Stand.

REF	ml	Niveles / Levels / Niveaux / Ebenen	V	Hz	Ø cm	H cm	W	
P15.096	700	3	230	50	21	38,0	250	1
P15.097	1200	4	230	50	23	45,0	250	1

Baño maría chocolate /
Chocolate warmer /
Chauffe-chocolat /
Wasserbad

P15010



INOX - ST/STEEL
EDELSTAHL
18/10

Temp. Max 40 °C



IDEA! Especial chocolate
Special chocolate
Spécial chocolat
Spezial Schokolade

REF	Unidades / Units / Unités / Einheit	Lts	V	W	
P15.010	1	3,50	230	250	1

Nueva gama de carros calientes para banquetes y catering, que le permitirán acercar la cocina allí donde esté el cliente, asegurando la máxima calidad y la entrega de los platos por encima de los 65 °C.

New range of heated trolleys for banquets and other catering events, a range that enables you to take the kitchen to customer, guaranteeing maximum quality and the delivery of dishes at temperatures above 65 °C.

Nouvelle gamme de chariots chauds pour banquetes et service traiteur (catering), pour vous permettre de rapprocher la cuisine du lieu où se trouve le client, en garantissant la qualité maximale et la livraison des plats au-dessus de 65 °C.

Neue Produktpalette von Warmhalteschränken für Banketts und Catering, um die Küche dem Kunden anzunähern, um ihm eine maximale Qualität und eine Speisenslieferung von über 65 °C zu versichern.

UNIFORMIDAD DE CIRCULACIÓN DEL AIRE CALIENTE / EVEN CIRCULATION OF HOT AIR / UNIFORMITÉ CIRCULATION AIR CHAUD / EINHEITLICHE HEISSLUFTZIRKULATION

Circulación uniforme y constante del aire gracias a un sistema único que imposibilita el contacto de las cubetas con el fondo o las paredes.

The circulation of air is even and constant thanks to a unique system that makes it impossible for the containers to touch the cabinet base or sides.

La circulation d'air chaud est uniforme et constant grâce à un système unique qui empêche que les bacs touchent le fond ou les parois.

Einheitliche und konstante Heissluftzirkulation dank eines einzigartigen Systems, welches den Kontakt der Behälter mit den Böden oder Wänden unmöglich macht.



1 AISLAMIENTO EN LANA DE ROCA / ROCKWOOL INSULATION / ISOLATION EN LAINE DE ROCHE / ISOLIERUNG MIT STEINWOLLE

+ DURADERO

Aislamiento térmico en lana de roca evitando la deformación con el calor y ampliando la vida útil del armario.

+ AHORRO ENERGÉTICO

Gracias al extraordinario sistema de aislamiento, se consigue el grado de temperatura deseado, con mayor rapidez y permite conservar el calor durante un periodo de tiempo más prolongado.

+ HIGIÉNICO

Con el sistema de guías monobloc (sin soldaduras) la limpieza interior es mayor, más fácil y rápida.

+LONG LASTING

Thermal insulation provided by rockwool preventing deformation through heat and lengthening the useful life of the cabinet.

+ENERGY SAVING

Thanks to the extraordinary thermal insulation system, the desired temperature is achieved more quickly and the heat is conserved for longer periods.

+HYGIENE

With the exclusive system of monoblock guides (without welds) cleanliness inside is grater, easier and faster.

+DURABLE

Isolation thermique en laine de roche pour éviter la déformation par la chaleur et augmenter la vie utile de l'armoire.

+HYGIÉNIQUE

Grâce au système exclusif de glissières monobloc (sans soudures) le nettoyage intérieur est plus parfait, plus aisé et plus rapide.

+ÉCONOMIE D'ÉNERGIE

Grâce à l'extraordinaire système d'isolation thermique, la température souhaitée s'obtient plus rapidement et cela permet de conserver la chaleur pendant une plus longue période de temps.

+ LANGLEBIGKEIT

Hitzeisolierung durch Steinwolle, welche eine Hitzedeformierung ausschliesst und die Gebrauchsdauer verlängert.

+ ENERGIEERSPARNIS

Dank des aussergewöhnlichen Isolierungsystems lässt sich die gewünschte Temperatur schnell erreichen und sie wird für einen längeren Zeitraum beibehalten.

+ HYGIENE

Mit dem Einschubführungssystem Monoblock (ohne Verschweissungen) ist die Reinigung des Inneren besser, einfacher und schneller.

2

CAPACIDAD / CAPACITY / CAPACITÉ / KAPAZITÄT

Guías monobloc (sin soldaduras) para rejillas acero inoxidable y cubetas Gastronorm 2/1 y 1/1. Para platos hasta diámetro 31 cm.
Monoblock guides (without welds) for St/Steel trays and Gastronorm containers 2/1 and 1/1. For dishes up to 31 cm diameter.

Glissières monobloc (sans soudures) pour grilles acier inoxydable et bacs Gastronorm 2/1 et 1/1. Pour des assiettes jusqu'à 31 cm diamètre.
Einschubführungen Monoblock (ohne Verschweißungen) für Roste aus rostfreiem Stahl und Gastronormbehälter 2/1 und 1/1. Für Teller bis zu einem Durchmesser 31 cm.

FÁCIL MANEJO / EASY HANDLING / MANUPULATION AISÉE / EINFACHE HANDHABUNG

**Asas posteriores.
Ruedas pivotantes & 360°.
Dos con freno**

*Back side handles.
Rotating wheels 360°.
Front wheels with brakes*

*Poignées postérieures.
Roues pivotantes 360°.
Roues avant avec freins*

*Griffe hinten.
Räder 360° drehbar.
Zwei mit Bremsen.*

3

BLOQUE CALÓRICO / HEAT BLOCK / BLOC CHAUFFANT / HITZEBLOCK

Extraíble sin necesidad de herramientas. Termostato regulador temperatura 0 °C a 100 °C. Recipiente humidificador integrado.

Extractable without the need of tools. Thermostat for regulation of temperature 0 °C to 100 °C. Provided with humidification container.

Amovele sans besoin d'outils. Thermostat régulateur de température 0 °C - 100 °C. Bac humidification intégré.

Auseinandernehmbar ohne den Bedarf von Werkzeugen. Regulierbares Thermostat von 0 °C a 100 °C. Integrierter Behälterluftbefeuchter.

P810

Ref. P81.000

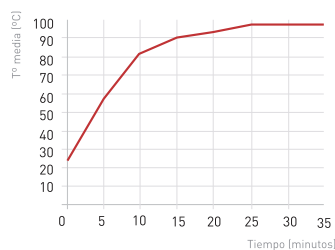

Ref. P81.010

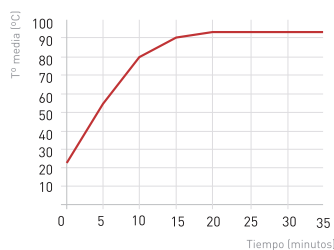

Ref. P81.020

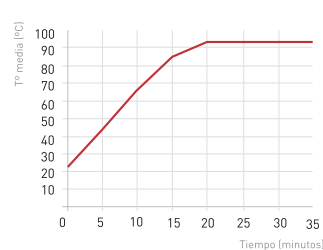

REF	Medidas Guías / Rails Dimensions / Dimensions Glissières / Einschubmasse	Capacidad / Capacity / Capacité / Fassungsvermögen	W	V	
P81.000	GN 2/1	10 GN 2/1 - 20 GN 1/1	3.000	230 V II	1
P81.010	GN 2/1	20 GN 2/1 - 40 GN 1/1	3.000	230 V II	1
P81.020	GN 2/1	40 GN 2/1 - 80 GN 1/1	4.000	230 V II	1



P15027 / P15028 Calentador de platos / Hot cupboards / Chauffe - assiettes / Tellerwärmer

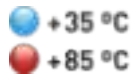

Ref. P15.027



**Medidas interiores / Inner sizes /
 Mesures interieures / Innenmasse**
 41 x 38 x 66,5 cm

P15.028



**Medidas interiores / Inner sizes /
 Mesures interieures / Innenmasse**
 70 x 35 x 80 cm

REF	Capacidad platos / Capacity plates / Capacité assiettes / Tellerkapazität	V	W	
P15.027	60	230	750	1
P15.028	120	230	1.250	1

Calentadores de platos Cater Chef. Acero inoxidable, doble pared, completamente aislado térmicamente. Con termostato e interruptor con piloto de control. Estantes interiores regulables y extraíbles. Puertas con bisagras muy reforzadas. Diámetro máximo de los platos de 32 cm.

Hot cupboards. St/Steel, wholly insulated. With thermostat and switch with indicator light, removable and adjustable shelves. Door with heavy duty hinges. Diameter max. plates 32 cm.

Chauffe-assiettes. Inox, double paroi, entièrement calorifugée, avec thermostat et interrupteur avec voyant de contrôle, étagères ajustables et amovibles. Porte avec charnières très résistantes. Diamètre max. assiettes 32 cm.

Tellerwärmer Cater Chef aus rostfreiem Stahl, Doppelwändig, komplett wärmeisoliert. Mit Thermostat und Schalter mit Kontrollleuchten. Innere Einlegeböden regulierbar und herausnehmbar. Türen mit verstärkten Scharnieren. Max. Tellerdiameter 32 cm.

SOLUCIONES PARA LA HELADERÍA /



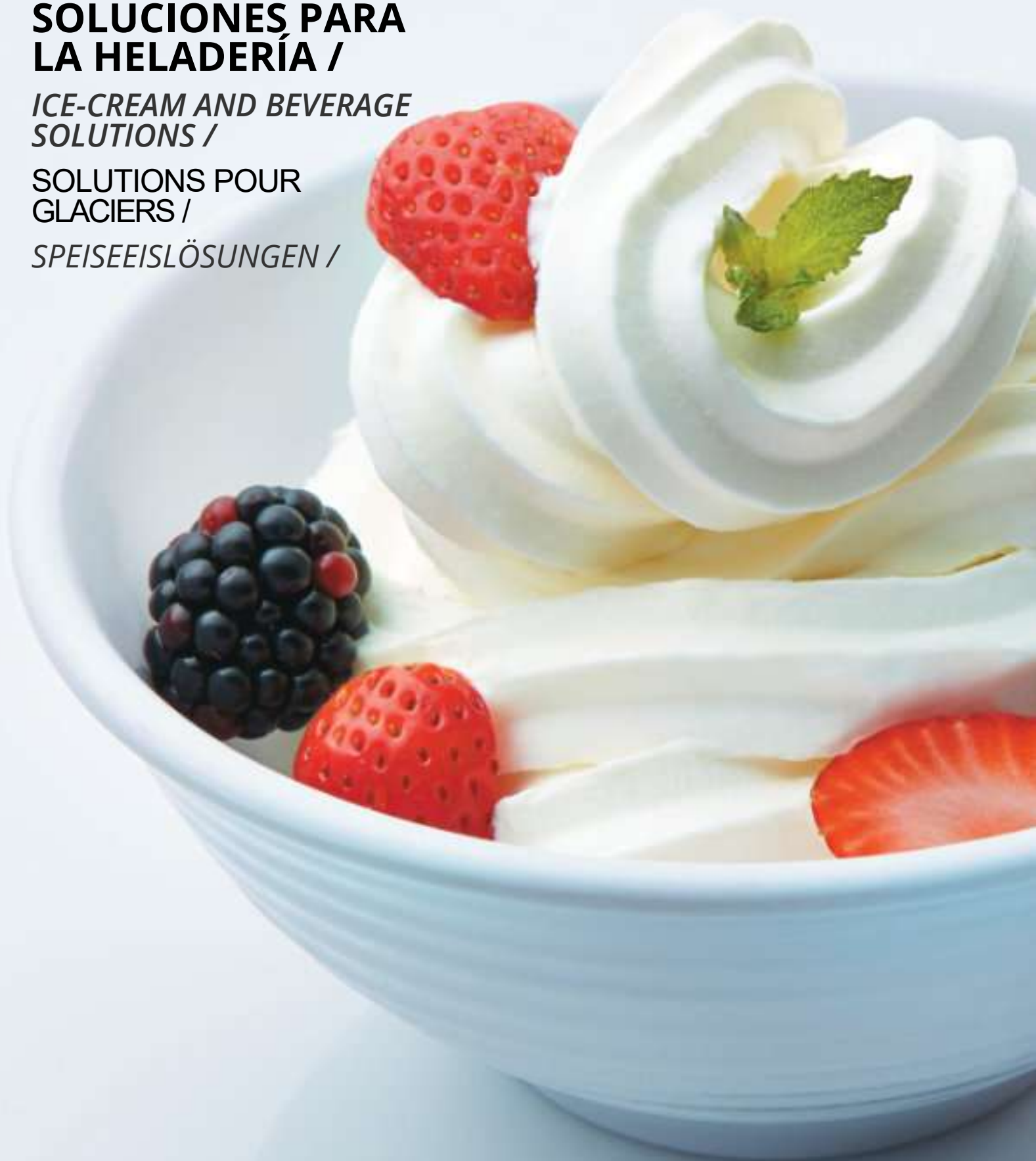

*ICE-CREAM AND BEVERAGE
SOLUTIONS /*

*SOLUTIONS POUR
GLACIERS /*

SPEISEISLÖSUNGEN /



MAQUINARIA HELADERÍA / ICE-CREAM MACHINES /
TURBINES À GLACE/ EISMASCHINEN

	GELATO 5K CREA SC	GELATO 3K TOUCH	GELATO CHEF 5L AUTOMATIC	GELATO CHEF 3L AUTOMATIC
COMPARATIVA / COMPARISON / COMPARATIF / VERGLEICH				
Alimentación / Power supply / Alimentation / Befüllung	220-240 V 50 Hz	220-240 V 50 Hz	220-240 V 50 / 60Hz	220-240 V 50 / 60Hz
Potencia / Power / Puissance / Leistung	650 W	350 W	280 W	200 W
Revoluciones por minuto / Revolutions per minute / Tours par minute / Umdrehungen pro Minute	70 RPM	63 RPM	63 RPM	63 RPM
Volumen contenedor / Container volume / Volume conteneur / Behältergröße	3,20 L	1,70 L	2,50 L	2 L
Desagüe / Drain / Vidange / Wasserablaufsystem	✓			
Cubeta extraíble / Removable pail / Cuve amovible / Herausnehmbarer Behälter		✓	✓	✓
Capacidad productiva por ciclo / Production capacity per cycle / Capacité productive par cycle / Verbesserte Produktionskapazität durch zyklischen Betrieb	1,25 Kg/ 1,75 L	0,8 Kg/ 1,20 L	1 Kg/ 1,50 L	1 Kg/ 1,50 L
Tiempo de preparación / Preparation time / Temps de préparation / Zubereitungszeit	12-15 min.	12-15 min.	20-30 min.	20-30 min.
Preparación máxima horaria / Maximum hourly preparation / Préparation maximum horaire / Maximierte stündliche Zubereitung	5 Kg/ 7,00 L	3 Kg/ 4,40 L	2 Kg/ 3,20 L	1,7 Kg/ 3 L
Programa de producción y conservación automática / Automatic production and preservation programme / Programme de production et conservation automatique / Programm für die automatische Produktion und Lagerung	✓			
Dimensiones / Dimensions / Dimensions / Abmessungen	465 x 480 x 395 mm 34 Kg	340 x 430 x 250 mm 21 Kg	450 x 320 x 315 mm 20 Kg	325 x 405 x 300 mm 19 Kg



MAQUINARIA /
EQUIPMENT /
EQUIPEMENT

GELATO 5K CREA SC

La mantecadora más compacta totalmente automática / *The most compact completely automatic ice-cream maker /*
La turbine à glace la plus compacte totalement automatique / *Die kompaktestevollautomatische Eismaschine*



AUTOMATIC



REF	Volumen contenedor / Container volume / Volume conteneur / Grosser behälter L	Producción horaria / Hourly production / Production horaire / Zubereitungszeit / Kg / L	W	V	Hz	Kg	
P38.250.250	3,20	5 / 7	650	220-240	50	34	1



Introducción fácil de ingredientes.
Easy introduction of ingredients.
Introduction facile d'ingrédients.
Einfache Befüllung.



Sistema de desague, fácil limpieza.
Easy clean, drain system.
Système d'écoulement, nettoyage facile.
Wasserablaufsystem, einfach zu reinigen.



Tapa con imán de seguridad.
Lid with safety magnet.
Couvercle à aimant de sécurité.
Deckel mit Magnetverschluss.



Raspadoras ajustables extraíbles.
Adjustable removable blades.
Raclours réglables amovibles.
Verstellbare Abstreifer, abnehmbar.



Función manual.
Manual function.
Fonction manuelle.
Manueller Betrieb.



4 programas de mantecación.
4 ice-cream making programmes.
4 programas de malaxaje.
Vier Eiszubereitungsprogramme.



4 x 4 programas de conservación.
4 x 4 conserving programmes.
4 x 4 programas de conservación.
4 x 4 Konservationsprogramme.

Mantecadora para producir, almacenar y distribuir helado.

- Produce helado de forma automática y en poco tiempo.
- Conserva el helado dentro de la máquina.
- Distribuir el helado directamente.
- Los 4 programas de mantecación.
 - Gelato clásico.
 - Gelato semi-soft.
 - Granita (Granizado).
 - Abatidor rápido de temperatura.
- Control de la densidad automática. La pala se detiene automáticamente cuando el helado está listo.
- Desagüe de limpieza.
- Cuerpo y pala en acero inoxidable.
- Refrigeración por aire.

Ice-cream maker to produce, store and dispense ice-cream.

- Quickly and automatically produce ice-cream.
- Conserve the ice-cream inside the machine.
- Dispense ice-cream directly.
- The 4 ice-cream making programmes.
 - Classic ice-cream.
 - Semi-soft ice-cream.
 - Granita (crystallised ice).
 - Fast chiller.
- Automatic density control. The blade stops automatically when the ice cream is ready.
- Cleaning drain.
- Stainless steel body and blade.
- Air cooling.

Turbine à glace pour produire, conserver et distribuer des glaces.

- Produit des glaces de façon automatique et en peu de temps.
- Conserve la glace dans la machine.
- Distribue directement les glaces.
- Les 4 programmes de malaxage.
 - Gelato classique.
 - Gelato semi-soft.
 - Granita (Granité).
 - Refroidisseur rapide de température.
- Contrôle de densité automatique. La pale s'arrête automatiquement quand la glace est prête.
- Écoulement de nettoyage.
- Corps et pale en acier inoxydable.
- Réfrigération à l'air.

Eismaschine für die Herstellung, Aufbewahrung und Ausgabe von Eis

- Automatische, schnelle Eisherstellung
- Aufbewahrung des Eis in der Maschine
- Ausgabe des Eis direkt aus der Maschine
- Die vier Eiszubereitungsprogramme
 - Klassisches Eis
 - Halbweiches (semi-soft) Eis
 - Granita (Slush - sizilianische Eisspeise).
 - Schnellfrierprogramm
- Automatische Kontrolle der Festigkeit. Die Rührklinge stoppt automatisch, wenn das Eis fertig ist.
- Ablaufreinigung.
- Körper und Klinge aus rostfreiem Stahl.
- Luftkühlung.

GELATO 3K TOUCH

Mantecadoras / Ice-cream makers / Turbines à glace / Eismaschine



REF	Volumen contenedor / Container volume / Volume conteneur / Grosser behälter L	Producción horaria / Hourly production / Production horaire / Zubereitungszeit / Kg / L	W	V	Hz	Kg	
P38.550.250	1,70	3 / 4,4	350	220-240	50	21	1



Sistema de desague, fácil limpieza.
Easy clean, drain system.
Système d'écoulement, nettoyage facile.
Wasserablaufsystem, einfach zu reinigen.

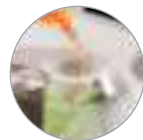

Introducción fácil de ingredientes.
Easy introduction of ingredients.
Introduction facile d'ingrédients.
Einfache Befüllung.



Tapa con imán de seguridad.
Lid with safety magnet.
Couvercle à aimant de sécurité.
Deckel mit Magnetverschluss.



Raspadoras ajustables extraíbles.
Adjustable removable blades.
Raclours réglables amovibles.
Verstellbare Abstreifer, abnehmbar.

Mantecadora para producir helados y sorbets.

- Control de la densidad automática. La pala se detiene automáticamente cuando el helado está listo.
- Cuerpo, cubeta fija y pala (con insertos reemplazables) en acero inoxidable.
- Refrigeración por aire.

Ice-cream maker to produce ice-cream and sorbets.

- Automatic density control. The blade stops automatically when the ice-cream is ready.
- Body, fixed pail and blade (with replaceable inserts) in stainless steel.
- Air cooled.

Turbine à glace pour produire des glaces et sorbets.

- Contrôle automatique de densité. La pale s'arrête automatiquement quand la glace est prête.
- Corps, cuve fixe et pale (à inserts interchangeables) en acier inoxydable.
- Réfrigération par air.

Eismaschine für die Herstellung von Eis und Sorbets.

- Automatische Kontrolle der Festigkeit. Die Klinge stoppt automatisch, wenn das Eis fertig ist.
- Körper, Eisbehälter und Schaufeln (mit auswechselbaren Einsätzen) Edelstahl.
- Luftkühlung.

GELATO CHEF 5L AUTOMATIC

Mantecadoras / Ice-cream makers / Turbines à glace / Eismaschine

REF	Volumen contenedor / Container volume / Volume conteneur / Grosser behälter L	Producción horaria / Hourly production / Production horaire / Zubereitungszeit / Kg / L	W	V	Hz	Kg	
P36.790.250	2,50	2 / 3,2	280	220-240	50	20	1



Tapa con imán de seguridad.
Lid with safety magnet.
Couvercle à aimant de sécurité.
Deckel mit Magnetverschluss.



Temporizador e interruptor refrigeración.
Timer and cooling switch.
Temporisateur et interrupteur réfrigération.
Zeitschaltuhr für Gefrierprozess.



Cubeta extraíble (aluminio).
Removable pail (aluminium).
Cuve amovible (aluminium).
Herausnehmbarer Behälter (Aluminium).



Raspadoras extraíbles.
Removable blades.
Racloirs amovibles.
Herausnehmbare Abstreifer.

Mantecedora para uso profesional.

- Control de la densidad automática. La pala se detiene automáticamente cuando el helado está listo.
- Cuerpo, cubeta fija y pala (con insertos reemplazables) en acero inoxidable.
- Timer mecánico de 60 minutos.
- Refrigeración por aire.

Ice-cream maker for professional use.

- Automatic density control. The blade stops automatically when the ice-cream is ready.
- Body, fixed pail and blade (with replaceable inserts) in stainless steel.
- 60 minute mechanical timer.
- Air cooled.

Turbine à glace à usage professionnel.

- Contrôle automatique de densité. La pale s'arrête automatiquement quand la glace est prête.
- Corps, cuve fixe et pale (à inserts interchangeables) en acier inoxydable.
- Minuteur mécanique de 60 minutes.
- Réfrigération par air.

Eismaschine für die professionelle Nutzung.

- Automatische Kontrolle der Festigkeit. Die Klinge stoppt automatisch, wenn das Eis fertig ist.
- Körper, Eisbehälter und Schaufeln (mit auswechselbaren Einsätzen) Edelstahl.
- Mechanische Zeitschaltuhr 60 Minuten.
- Luftkühlung.

GELATO CHEF 3L AUTOMATIC

Mantecadoras / Ice-cream makers / Turbines à glace / Eismaschine



REF	Volumen contenedor / Container volume / Volume conteneur / Grosser behälter L	Producción horaria / Hourly production / Production horaire / Zubereitungszeit / Kg / L	W	V	Hz	Kg	
P38.420.250	2	1,7 / 3	200	220-240	50	19	1



Tapa con imán de seguridad.
Lid with safety magnet.
Couvercle à aimant de sécurité.
Deckel mit Magnetverschluss.

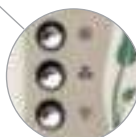

Temporizador e interruptor refrigeración.
Timer and cooling switch.
Temporisateur et interrupteur réfrigération.
Zeitschaltuhr für Gefrierprozess.



Cubeta extraíble (aluminio).
Removable pail (aluminium).
Cuve amovible (aluminium).
Herausnehmbarer Behälter (Aluminium).



Raspadoras extraíbles.
Removable blades.
Racloirs amovibles.
Herausnehmbare Abstreifer.

Mantecedora para uso profesional.

- Control de la densidad automática. La pala se detiene automáticamente cuando el helado está listo.
- Cuerpo, cubeta fija y pala (con insertos reemplazables) en acero inoxidable.
- Timer mecánico de 60 minutos.
- Refrigeración por aire.

Ice-cream maker for professional use.

- Automatic density control. The blade stops automatically when the ice-cream is ready.
- Body, fixed pail and blade (with replaceable inserts) in stainless steel.
- 60 minute mechanical timer.
- Air cooled.

Turbine à glace à usage professionnel.

- Contrôle automatique de densité. La pale s'arrête automatiquement quand la glace est prête.
- Corps, cuve fixe et pale (à inserts interchangeables) en acier inoxydable.
- Minuteur mécanique de 60 minutes.
- Réfrigération par air.

Eismaschine für die professionelle Nutzung.

- Automatische Kontrolle der Festigkeit. Die Klinge stoppt automatisch, wenn das Eis fertig ist.
- Körper, Eisbehälter und Schaufeln (mit auswechselbaren Einsätzen) Edelstahl.
- Mechanische Zeitschaltuhr 60 Minuten.
- Luftkühlung.

GELATO 12K ST

Mantecadoras / Ice-cream makers / Turbines à glace / Eismaschine



REF	Volumen contenedor / Container volume / Volume conteneur / Grosser behälter L	Producción horaria / Hourly production / Production horaire / Zubereitungszeit / Kg / L	W	V	Hz	Kg	
P38.160.250	6	12 / 16	1.300	220-240	50	73	1



Cubeta de conservación
Storage vat
Bac de conservation
Aufbewahrungsbehälter



Control de temperatura
Temperature control
Contrôle de la température
Temperaturkontrolle

La mantecadora Gelato 12k ST es capaz de producir 3 kg de helado en un ciclo de 15 minutos. La velocidad de rotación es regulable entre 60 y 130 rpm para conseguir la textura deseada.

Este modelo cuenta con extracción frontal del helado pero también con cuba de conservación cuya temperatura puede ser seleccionada por el usuario.

La Gelato 12k ST gracias a la tecnología empleada tiene un peso reducido y se puede transportar y mover fácilmente, estando equipada con 4 ruedas, las cuales se pueden bloquear. De fácil limpieza todas las piezas están hechas de acero inoxidable. Refrigerada por aire.

The Gelato 12k ST churn is capable of producing 3 kg of ice cream in a 15-minute cycle. The rotation speed is adjustable between 60 and 130 rpm for achieving the desired texture.

This model has front extraction of the ice cream but also has a storage vat where temperature can be selected by the user.

Thanks to the technology used, the Gelato 12k ST is lighter and can be easily transported and moved about, having 4 wheels which can be locked. Easy to clean as all parts are made of stainless steel. Air-cooled.

Turbine à glace Gelato 12k ST peut produire 3 kg de glace en un cycle de 15 min. La vitesse de rotation est réglable entre 60 et 130 rpm pour obtenir la texture souhaitée.

De la glace est également doté d'un bac de conservation dont la température peut être sélectionnée par l'utilisateur.

Grâce à la technologie appliquée la Gelato 12k ST a un faible poids et peut être transportée et déplacée facilement, étant équipée de 4 roues blocables. Nettoyage facile de toutes les pièces qui sont en acier inoxydable. Refroidissement par air.

Die Gelato 12k ST Eismaschine ist in der Lage, 3 kg Eis in einem 15-minütigen Zyklus zuzubereiten. Die Drehgeschwindigkeit ist zwischen 60 und 130 U / min einstellbar, um die gewünschte Konsistenz zu erreichen.

Dieses Modell verfügt über eine frontale Eisentnahme und auch über einen Aufbewahrungsbehälter, dessen Temperatur vom Bediener eingestellt werden kann.

Dank der eingesetzten Technologie hat die Gelato 12k ST Eismaschine ein geringes Gewicht und kann leicht transportiert und bewegt werden, da sie mit 4 Rädern ausgestattet ist, die blockiert werden können. Alle Teile sind für eine leichte Reinigung aus Edelstahl gefertigt. Luftgekühlt.



INOX - ST/STEEL
EDELSTAHL

2000 RPM

2 velocidades (1-2 minutos).
2 speeds (1-2 minutes).
2 vitesses (1-2 minutes).
2 geschwindigkeiten (1-2 minuten).



FRIX'AIR

Emulsionador y procesador de alimentos / Food emulsifier and processor /
Émulsionneur et processeur d'aliments / Emulgator und Küchenmaschine

REF	W	V	Hz	Kg	
P94.500.250	600	220-240	50/60	21	1

Procesador profesional que permite emulsionar, mezclar y triturar tanto alimentos congelados como frescos.

Frix'Air funciona con recipientes monodosis de 180 ml con muchas ventajas:
- Máxima higiene.
- Congelación muy rápida.
- Disponibilidad inmediata de varias preparaciones.
- Garantiza la cadena de frío.
- Ocupan poco espacio.
- Apilables.

Robot professionnel à émulsionner, mixer et mouliner des aliments surgelés ou frais.

Frix'Air fonctionne à l'aide de récipients monodose de 180 ml offrant de nombreux avantages:
- Hygiène maximum.
- Congélation très rapide.
- Disponibilité immédiate de plusieurs préparations.
- Garantit la chaîne du froid.
- Prend peu de place.
- Empilables.

Accesorios incluidos:

- 2 Cuchillas de acero inoxidable.
- 1 Cuchilla de plástico.
- 2 Junta protectora.
- 2 Lleva recipientes en acero.
- 5 Recipientes de plástico con tapa.
- 1 Desmontador de cuchilla.

Accessoires inclus :

- 2 lames en acier inoxydable.
- 1 lame en plastique.
- 2 joints protecteurs.
- 2 Muni de récipients en acier.
- 5 Récipients en plastique avec couvercle.
- 1 Outil démontage de lame.

Professional processor that allows emulsifying, mixing and blending of both frozen and fresh food.

Frix'Air works with 180 ml single-dose containers with many advantages:
-Maximum hygiene.
-Very quick freezing.
-Immediate availability of various preparations.
-It guarantees the cold chain.
-They take up little space.
-Stackable.

Profi-Processor, zum Emulgieren, Mischen und Zerkleinern von sowohl gefrorene und als auch frische Lebensmittel.

Frix'Air arbeitet mit 180 ml Einzelbehältern mit vielen Vorteilen:
- Maximale Hygiene.
- Sehr schnelles Einfrieren.
- Sofortige Verfügbarkeit der verschiedenen Zubereitungen.
- Gewährleistet Kühlkette.
- Raumsparend.
- Stapelbar.

Accessories included:

- 2 St/Steel blades.
- 1 Plastic blade.
- 2 Protective seals.
- 2 Stainless steel containers.
- 5 Plastic containers with lid.
- 1 Blade remover.

Zubehör im Lieferumfang enthalten:

- 2 Edelstahlklingen.
- 1 Kunststoffmesser.
- 2 Schutzstecker
- 2 Stahlbehälter eingeschlossen.
- 5 Kunststoffbehälter mit Deckel.
- 1 Abnehmbare Klinge.

H.A.C.C.P.
NO PROBLEM



Colores / Colours / Couleurs / Farben



Cada pack contiene 10 u. de cada color.
Each pack contains 10 units of each color.
Chaque pack contient 10 u. de chaque couleur.
Jedes Set enthält zehn Stück jeder Farbe.



Ideal para preparar mousses, sorbetes, helados, salsas, sopas, cócteles y aperitivos.
Ideal for preparing mousses, sorbets, ice-creams, sauces, soups, cocktails and apéritifs.
Idéal pour préparer des mousses, sorbets, glaces, sauces, soupes, cocktails et apéritifs.
Ideal für die Herstellung Mousses, Sorbets, Eis, Soßen, Suppen, Cocktails und Aperitifs.

Set recipientes Frix'Air en plástico para congelador y microondas /
Set of Frix'Air plastic containers for freezers and microwaves /
Set récipients Frix'Air en plastique pour congélateur et micro-ondes /
Plastikbehälter Frix'Air zum Einfrieren und für die Mikrowelle

REF	ml	Ø mm	H mm	
P99.00.000	180	72	95	50



Fácil identificación y separación de diferentes preparaciones.
Easy for identification and separation of different foodstuffs.
Identification et séparation faciles des différentes préparations.
Einfaches Erkennen und Unterscheiden unterschiedlicher Zubereitungen.

MAQUINARIA /
EQUIPMENT /
EQUIPMENT



































Ver productos en / See products on / Voir produits en page / Siehe produkte in **P.**
148

RACIONADOR HELADO /
ICE CREAM SCOOP /
CUILLÈRE À GLACE /
EISKUNGLPORTIONIERER





MELAMINA Y PRESENTACIÓN / MELAMINE & PRESENTATION / MÉLAMINE ET PRÉSENTATION / MELAMIN UND PRÄSENTATION

	GREY SOUL 348		MEDITERRANEAN 360		COMPLEAT TABLE 372
	WATER 350		COLORS 361		VENUS 374
	DEEP BLUE 350		COOL-LINE 362		PASTRY 375
	OCEAN 351		ZEN 364		WOOD 376
	GOLDEN 352		SHELL 365		STONE BOARD 378
	VERSATIL 353		BLANCHE 366		GN COOL-LINE 380
	STYLISH 354		FONTANA 366		GN CLASSIC 381
	CLASSIC 354		OLA 367		GN SLIM 382
	NATURAL 355		SHARING 368		STANDS 385
	TERRACOTA 356		CANON 370		MINI 387
	STONE 358		LIFE 371		CENICEROS 389
	ELEGANCE 359				



CARACTERÍSTICAS / MAIN FEATURES / PRINCIPALES CARACTÉRISTIQUES / PRODUKTMERKMALE



Contacto con alimentos: certificado por SGS
Food contact approved: certified by SGS
Contact avec aliments: certifié par SGS
Kontakt mit lebensmitteln: zertifiziert durch SGS



Condiciones de trabajo: entre -20°C y +70°C
Withstands temperatures: -20°C & +70°C
Températures entre: -20°C et +70°C
Arbeitstemperaturen: zwischen -20°C und +70°C

USOS / USES / USAGES / GEBRAUCH



No recomendada: Microondas
Not recommended: Microwave
Non recommandée: Micro-ondes
Nicht empfohlen: Mikrowellen



No recomendada: Directo al fuego
Not recommended: Direct flame
Non recommandée: Direct au feu
Nicht empfohlen: Direkte flamme



No recomendada: Horno
Not recommended: Oven
Non recommandée: Four
Nicht empfohlen: Öfen



No recomendada: Aceite y productos químicos
Not recommended: Oil and chemical products
Non recommandée: Huile ou produits chimiques
Nicht empfohlen: Öl und chemische produkte

Es un material muy utilizado en el servicio de mesa y presentación por sus propiedades.

It is highly recommended for table & buffet service for its properties.

Très utilisée dans le service de table et buffet par ses propriétés.

Aufgrund seiner eigenschaften ist es ein vielbenutztes material für den tischservice und die präsentation.

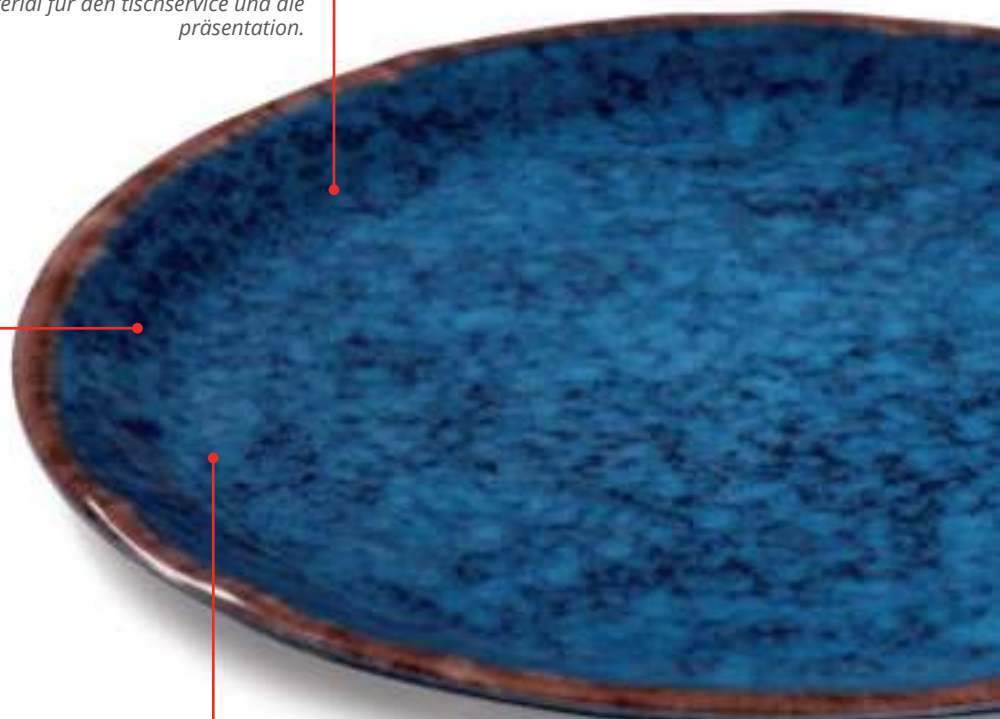

La melamina es una resina sintética que se endurece y toma forma después de un proceso de calentamiento /

Melamine is a synthetic resin Which becomes harden and Formed after heating /

La mélamine est une résine Synthétique qui se durcit et prend-forme après un processus spécial de Chauffage /

Melamin ist ein kunstharz, welches sich verhärtet und nach einem erhitzungsprozess eine form annimmt.

PROPIEDADES / PROPERTIES / PROPRIÉTÉS/EIGENSCHAFTEN



Resistente al calor
Heat resistant
Résistante à la chaleur
Hitzebeständig



Inodoro
Non-odorous
Inodore
Geruchlos



Poco conductor del calor
Low heat conductivity
Baisse conductivité de la chaleur
Geringe wärmeleitung



Resistente a la corrosión
Corrosion resistant
Résistante à la corrosion
Resistent gegen korrosion



Ligero
Light weight
Légère
Leicht



No tóxico
Non-toxic
Non-toxique
Nicht giftig



Indeformable
Free form deformation
Indéformable
Unverformbar



P22888 Plato cuadrado / Square plate / Assiette carrée / Quadratischer Teller



REF	cm	H cm	
P22.888	15 x 15	2,00	1
P22.889	18 x 18	2,00	1
P22.891	21 x 21	2,05	1

P22892 Plato triangular / Triangular plate / Assiette triangulaire / Dreieckiger Teller



REF	cm	H cm	
P22.892	20 x 20	6,8	1

P22893 Bandeja rectangular / Rectangular tray / Plateau rectangulaire / Rechteckiges Tablett



REF	cm	H cm	
P22893	21,6 x 11	2,5	1
P22894	29 x 11	2,5	1

P22896 Bandeja snacks o salsas / Snacks or sauce tray / Plateaux sauces / Schale für Snacks oder Sossen



P22.896

P22.897



REF	cm	H cm	
P22896	6,5 x 6,5	2,8	1
P22897	11,5 x 6,5	2,8	1

P22898 Bol redondo inclinado / Slanted round bowl / Bol rond incliné / Schräge runde Schale



REF	Ø cm	H cm	
P22898	14,5	10,5	1
P22899	17,5	12,2	1

P22308 Plato tapas / Tapas dish / Plat à tapas / Tapas Teller



REF	Ø cm	H cm	
P22.308	14,0	2,5	1
P22.309	16,5	2,8	1

P22306 Plato / Plate / Assiete / Teller



REF	Ø cm	H cm	
P22.306	19	2	1
P22.307	21,5	2,5	1

P22303 Bol redondo / Round bowl / Bol rond / Runde Schüssel



P22.303

P22.304

REF	Ø cm	H cm	
P22.303	14,5	5,5	1
P22.304	24	6	1

P22305 Bol cónico / Conical bowl / Bol conique / Konische Schüssel



REF	Ø cm	H cm	
P22.305	12	6,5	1

P22895 Bol redondo / Round bowl / Bol rond / Runde Schüssel



NEW!

REF	Ø cm	H cm	
P22.895	11	4,5	1

P22301 Fuente oval / Oval serving dish / Plat ovale / Ovale Buffetschale



REF	cm	H cm	
P22.301	29,5 x 18	3,5	1
P22.302	34,5 x 22	4	1



P22318 Plato / Plate / Assiete / Teller



REF	Ø cm	H cm	
P22.318	25,0	1,5	1
P22.319	27,5	1,5	1
P22.320	30,0	1,5	1

P22321 Plato hondo / Deep dish / Assiette creuse / Tief Teller



REF	cm	H cm	
P22.321	23 x 17,5	6,5	1

DEEP BLUE

P22332 Plato presentación / Serving plate / Assiette présentation / Präsentierteller-Teller



REF	cm	H cm	
P22.332	30 x 28,5	4,5	1



P22316 Bol redondo / Round bowl / Bol rond / Runde Schüssel



REF	Ø cm	H cm	
P22.316	17	5	1

P22317 Plato hondo / Deep dish / Assiette creuse / Tief Teller



REF	Ø cm	H cm	
P22.317	22,5	5	1

P22314 Plato / Plate / Assiete / Teller



REF	Ø cm	H cm	
P22.314	22	2	1
P22.315	27	2	1

P22313 Bandeja rectangular / Rectangular tray / Plateau rectangulaire / Rechteckiges Tablett



REF	cm	H cm	GN	
P22313	53,0 x 32,5	2	1/1	1
P22312	32,5 x 26,5	2	1/2	1
P22310	32,5 x 17,6	2	1/3	1
P22311	53,0 x 16,5	2	2/4	1



P22344 Plato / Plate / Assiete / Teller



REF	Ø cm	H cm	
P22.344	23,0	3,0	1
P22.345	27,5	3,5	1
P22.346	32,0	4,0	1

P22347 Plato presentación / Serving plate / Assiette présentation / Präsentierteller-Teller



REF	cm	H cm	
P22.347	29 x 26,5	1,5	1

P22886 Plato presentación / Serving plate / Assiette présentation / Präsentierteller-Teller



REF	cm	H cm	
P22.886	25,9 x 16,7	2,0	1

P22348 Fuente oval / Oval serving dish / Plat ovale / Ovale Buffetschale



REF	cm	H cm	
P22.348	30,5 x 11	3,0	1
P22.884	35,5 x 12,8	3,0	1
P22.885	40,6 x 14,7	3,0	1

P22887 Plato 2 compartimentos / Plate 2 compartments / Assiette 2 compartiments / Teller 2 Fächer



REF	cm	H cm	
P22.887	28,4 x 11	2,5	1



P22339 Plato tapas / Tapas dish / Plat à tapas / Tapas Teller



REF	cm	H cm	
P22.339	13 x 15,5	4	1
P22.341	15 x 15,0	2,5	1

P22340 Plato / Plate / Assiete / Teller



REF	Ø cm	H cm	
P22.340	19,5	3	1

P22336 Plato hondo / Deep dish / Assiette creuse / Tief Teller



REF	Ø cm	H cm	
P22.336	25,5	5,5	1

P22337 Fuente oval / Oval serving dish / Plat ovale / Ovale Buffetschale



REF	cm	H cm	
P22.337	23 x 16,5	3	1
P22.338	28 x 20,0	3	1

P22342 Bandeja rectangular / Rectangular tray / Plateau rectangulaire / Rechteckiges Tablett



REF	cm	H cm	
P22.342	31,5 x 23	3	1
P22.343	33,5 x 13	3	1

13.1 MELAMINA / MELAMINE /
MÉLAMINE / MELAMIN

STYLISH



P22333 Plato / Plate / Assiete / Teller



REF	Ø cm	H cm	
P22.333	20	2,0	1
P22.334	27	2,5	1
P22.335	31	3,0	1

CLASSIC



P22329 Bol cónico / Conical bowl / Bol conique / Konische Schüssel



REF	Ø cm	H cm	
P22.329	17	6	1
P22.330	22	8	1
P22.331	25	9	1



P22324 Bandeja rectangular / Rectangular tray / Plateau rectangulaire / Rechteckiges Tablett

REF	cm	H cm	GN	
P22.324	32,5 x 26,5	4	1/2	1
P22.328	32,5 x 26,5	4	1/2	1



P22.324



P22.328

P22323 Bandeja rectangular / Rectangular tray / Plateau rectangulaire / Rechteckiges Tablett

REF	cm	H cm	GN	
P22.323	32,5 x 17,6	4	1/3	1
P22.327	32,5 x 17,6	4	1/3	1



P22.323



P22.327

P22322 Bandeja rectangular / Rectangular tray / Plateau rectangulaire / Rechteckiges Tablett

REF	cm	H cm	GN	
P22.322	53 x 16,5	4	2/4	1
P22.326	53 x 16,5	4	2/4	1



P22.322



P22.326

P22325 Bandeja forma hoja / Leaf plate / Plateau forme feuille / Schale Blattform

REF	cm	H cm	
P22.325	37,5 x 15	2	1





P22740 Plato tapas / *Tapas dish / Plat à tapas / Tapas Teller*



REF	Ø cm	H cm	
P22.740	19,0	4,0	1
P22.741	24,0	5,1	1
P22.742	28,5	6,5	1
P22.743	35,5	6,5	1

P22744 Plato tapas / *Tapas dish / Plat à tapas / Tapas Teller*



REF	Ø cm	H cm	
P22.744	10,5	3,5	1
P22.745	13,0	4,0	1
P22.746	15,5	4,5	1

P22750 Bandeja cuadrada / *Square tray / Plateau carré / Quadratische Schale*



REF	cm	H cm	
P22.750	20,5 x 20,5	3,0	1
P22.751	25,5 x 25,5	3,5	1
P22.752	29,0 x 29,0	4,0	1

P22755 Bandeja rectangular / *Rectangular tray / Plateau rectangulaire / Rechteckiges Tablett*



REF	cm	H cm	
P22.755	21 x 11	2,0	1
P22.756	26 x 13	3,0	1

P22760 Bandeja snacks o salsas / *Snacks or sauce tray / Plateaux sauces / Schale für Snacks oder Sossen*



REF	cm	H cm	
P22.760	29,5 x 9,5	3,0	1



P22700 Bol cónico / Conical bowl / Bol conique / Konische Schüssel



REF	Ø cm	H cm	
P22.700	9,5	5,5	1
P22.701	11,5	5,5	1
P22.702	15,0	6,0	1
P22.703	18,0	9,5	1
P22.704	20,5	7,5	1
P22.705	23,0	8,0	1

P22710 Plato tapas / Tapas dish / Plat à tapas / Tapas Teller



REF	Ø cm	H cm	
P22.710	10,5	3,5	1
P22.711	15,5	4,5	1
P22.712	18,0	4,5	1

P22770 Plato presentación / Serving plate / Assiette présentation / Präsentierteller-Teller



P22.772



P22.770

REF	cm	H cm	
P22.770	22,0 x 18,5	1,0	1
P22.772	44,5 x 35,0	1,5	1



P22824 Bol redondo / Round bowl / Bol rond / Runde Schüssel



REF	Ø cm	H cm	
P22.824	11,5	4,0	1
P22.823	14,0	5,5	1
P22.825	19,0	6,5	1

P22815 Plato / Plate / Assiette / Teller



REF	Ø cm	H cm	
P22.815	22,5	3,0	1
P22.816	25,0	3,0	1
P22.817	27,5	3,5	1

P22850 Tabla presentación curvada / Curved board / Planche incurvée présentaion / Servierbrett



REF	cm	H cm	
P22.850	20,0 x 14,0	2,0	1
P22.851	25,0 x 17,5	2,5	1
P22.852	30,0 x 20,0	2,5	1

P22800 Tabla presentación / Serving board / Planche de service / Servierbrett



REF	cm	H cm	
P22.800	21 x 12	2,5	1
P22.801	24 x 14	2,5	1
P22.802	27 x 18	2,5	1
P22.803	33 x 19	2,5	1



P22782 Bandeja exhibición rectangular / Oblong display tray / Plateau rectangulaire / Quadratische Präsentationsplatte



REF	cm	H cm	
P22.782	35 x 25	4,0	1

P22780 Fuente rectangular / Oblong plate / Plateau rectangulaire / Quadratische Schale



REF	cm	H cm	
P22.780	25 x 16	3,0	1

P22781 Bandeja rectangular / Rectangular tray / Plateau rectangulaire / Rechteckiges Tablett



REF	cm	H cm	
P22.781	32 x 12	2,5	1

P22783 Fuente oval / Oval serving dish / Plat ovale / Ovale Buffetschale



REF	cm	H cm	
P22.783	35 x 15	2,5	1

P22784 Bandeja forma hoja / Leaf plate / Plateau forme feuille / Schale Blattform



REF	cm	H cm	
P22.784	34,5 x 13,5	3,0	1



P22725 Plato / Dish / Assiette / Teller



REF	Ø cm	H cm	
P22.720	22,0	2,0	1
P22.725	27,0	2,0	1

P22726 Plato hondo / Deep dish / Assiette creuse / Tief Teller



REF	Ø cm	H cm	
P22.726	20,0	3,5	1

P22727 Fuente rectangular / Oblong plate / Plateau rectangulaire / Quadratische Schale



REF	cm	H cm	
P22.727	20,0 x 14,5	4,5	1
P22.728	23,0 x 17,5	4,5	1
P22.729	27,0 x 20,0	4,5	1

P22758 Bol redondo / Round bowl / Bol rond / Runde Schüssel



REF	Ø cm	H cm	
P22.758	12,5	7,0	1

P22759 Vaso / Glass / Verre / Becher



REF	Ø cm	H cm	
P22.759	8,0	9,5	1



P22830 Plato presentación / Serving plate /
Assiette présentation / Präsentierteller-Teller



Amarillo / Yellow /
Jaune / Gelb

REF	Ø cm	H cm	
P22.830	22	2,5	1
P22.833	28	2,5	1

P22834 Plato presentación / Serving plate /
Assiette présentation / Präsentierteller-Teller



Gris / Grey /
Gris / Grau

REF	Ø cm	H cm	
P22.834	22	2,5	1
P22.835	28	2,5	1

P22838 Plato presentación / Serving plate /
Assiette présentation / Präsentierteller-Teller



Naranja / Orange

REF	Ø cm	H cm	
P22.838	22	2,5	1
P22.839	28	2,5	1

P22844 Plato presentación / Serving plate /
Assiette présentation / Präsentierteller-Teller



Rojo / Red /
Rouge / Rot

REF	Ø cm	H cm	
P22.844	22	2,5	1
P22.845	28	2,5	1



P23800 Mini cacerola con tapa / Mini round casserole with lid /
Mini cocotte avec couvercle / Minikasserolle mit Deckel

P23.800A



P23.800N



P23.800G



P23.800R



REF	Ø cm	H cm	
P23.800A	10 x 10	6,5	1
P23.800N	10 x 10	6,5	1
P23.800G	10 x 10	6,5	1
P23.800R	10 x 10	6,5	1

P22223 Base de madera para 3 mini cacerolas / Wood base for 3 mini casseroles /
Base en bois pour 3 mini cocottes / Holzständer für 3 minikasserolle



REF	cm	H cm	
P22.223	43 x 15,5	5,1	1



Compatible with P23.800, P23.800A,
P23.800N, P23.800G, P23.800R.

Suitable for P23.800, P23.800A, P23.800N,
P23.800G, P23.800R.

Adaptable pour P23.800, P23.800A,
P23.800N, P23.800G, P23.800R.

Geeignet für P23.800, P23.800A, P23.800N,
P23.800G, P23.800R.

P22884 Vaso / Glass / Verre / Becher

P22.884A



P22.884G



P22.884B



P22.884N



P22.884R



P22.884NE



REF	Ø cm	H cm	ml	
P22.884A	8,5 x 8,5	9	30	1
P22.884N	8,5 x 8,5	9	30	1
P22.884G	8,5 x 8,5	9	30	1
P22.884R	8,5 x 8,5	9	30	1
P22.884B	8,5 x 8,5	9	30	1
P22.884NE	8,5 x 8,5	9	30	1



P22370 Bol cuadrado hondo dos colores / Two tones deep squared bowl /
Bol carré deux couleurs / Zweifarbige tiefe quadratische Schüssel

P23.370A



P23.370N



REF	cm	H cm	
P22.370A	9 x 9	5,5	1
P22.370N	9 x 9	5,5	1
P22.370G	9 x 9	5,5	1
P22.370R	9 x 9	5,5	1

P23.370G



P23.370R



P22371 Bol cuadrado hondo dos colores / Two tones deep squared bowl /
Bol carré deux couleurs / Zweifarbige tiefe quadratische Schüssel

P23.371A



P23.371N



REF	cm	H cm	
P22.371A	18 x 18	8,5	1
P22.371N	18 x 18	8,5	1
P22.371G	18 x 18	8,5	1
P22.371R	18 x 18	8,5	1

P23.371G



P23.371R



P590007 Tapa / Lid / Couvercle / XXX

Cierre no hermético /
Non-hermetic closure /
Fermeture non hermétique /
Verschluss nicht luftdicht

Polipropileno /
Polypropylene /
Polypropylène /
Polypropylen



REF	cm	H cm	
P59.0007	18 x 18	2,5	6

Compra mínima: pack 6u /
Minimum purchase: pack of 6 units /
Achat minimum : pack de 6 unités /
Mindestabnahme: Packung mit 6 Stück



Compatible con bol cuadrado hondo.
Suitable for deep squared bowl.
Adaptable pour bol carré.
Geeignet für tiefe quadratische Schüssel



P2290 Plato / Dish / Assiette / Platte



REF	Ø mm	H mm	
P22.901	195	28	12
P22.902	280	29	12

P2297 Bol para noodles / Noodles bowl /
Bol pour nouilles / Nudelschüssel



REF	Ø mm	H mm	
P22.971	173	76	12
P22.972	250	87	6

P2291 Bol / Bowl / Bol / Schüssel



REF	Ø mm	H mm	
P22.911	101	40	12
P22.912	115	58	12

P2296 Bol para salsas / Sauce bowl /
Bol pour sauces / Schüssel für Sossen



REF	Ø mm	H mm	
P22.960	115	55	20

P2295 Plato para bol / Dish for bowl /
Assiette pour bol / Unterteller für Schüssel



REF	mm	H mm	
P22.950	159 x 127	23	12

P2294 Bandeja rectangular / Rectangular Tray /
Plateau rectangulaire / Rechteckiges Tablett



REF	mm	H mm	
P22.940	234 x 147	25	12



P22354 Fuente / Plate / Plateau / Schale

REF	cm	H cm	
P22.354	25 x 23,5	3,0	1
P22.355	40 x 38,5	6,5	1



P22.354



P22.355

P22356 Fuente / Plate / Plateau / Schale

REF	cm	H cm	
P22.356	35 x 26,5	3,5	1
P22.357	46 x 35,0	5,0	1



P22358 Fuente / Plate / Plateau / Schale

REF	cm	H cm	
P22.358	28,5 x 27,5	7,0	1





P22349 Bandeja rectangular / Rectangular tray / Plateau rectangulaire / Rechteckiges Tablett



REF	cm	H cm	
P22.349	25 x 18,0	3,5	1
P22.350	30 x 21,5	4,0	1
P22.351	35 x 25,0	4,0	1

P22352 Bol redondo / Round bowl / Bol rond / Runde Schüssel



REF	Ø cm	H cm	
P22.352	17,5	5,5	1
P22.353	24,0	8,0	1

FONTANA

P22359 Bol redondo inclinado / Slanted round bowl / Bol rond incliné / Schräge runde Schale



REF	cm	H cm	
P22.359	35,5 x 32	14,5	1
P22.360	46 x 40,5	18,5	1



P2297 Bol redondo / Round bowl / Bol rond / Runde Schüssel



REF	Ø mm	H mm	
P22.973	250	110	1
P22.974	280	120	1
P22.975	350	150	1

P. 451



P22170 Bandeja forma hoja / Leaf plate / Plateau forme feuille / Schale Blattform



REF	mm	H mm	
P22.170	505 x 240	70	3

P22169 Bol oval / Oval bowl / Bol ovale / Ovale Schüssel



REF	mm	H mm	
P22.169	290 x 165	150	6

P2217 Bol torneado / Spin round bowl / Bol tourné / Gedrehte Schüssel



REF	Ø mm	H mm	
P22.171	205	95	3
P22.172	245	105	3
P22.173	280	120	3



Fuente rectangular alta /
High oblong plate /
Plateau rectangulaire haut /
Hohe rechteckige Schale

P22037



REF	mm	H mm	
P22.037	500 x 200	50	3

Fuente rectangular alta /
High oblong plate /
Plateau rectangulaire haut /
Hohe rechteckige Schale

P22038



REF	mm	H mm	
P22.038	350 x 250	50	3

Fuente rectangular /
Oblong serving dish /
Ravier /
Quadratische Schale

P22164



REF	mm	H mm	
P22.164	250 x 150	70	3
P22.165	350 x 250	70	3
P22.166	450 x 300	70	2

Bandeja 5 compartimentos /
5 - Compartment bowl /
Bol 5 compartiments /
Schale 5 Unterteilungen

P22103



Espacio central ideal para salsas y dipear.
Central space ideal for sauces and dips.
Espace central idéal pour sauces et tartiner.
Das perfekte Mittelstück für Sossen und Dips.

REF	Ø mm	H mm	
P22.103	380	65	3

P22501 Fuente oval / Oval serving dish /
Plat ovale / Ovale Buffetschale



REF	mm	H mm	
P22.501	325 x 200	40	1
P22.502	435 x 265	40	1

P2210 Bol redondo / Round bowl /
Bol rond / Runde Schüssel



REF	Ø mm	H mm	
P22.100	160	90	6
P22.101	260	100	6
P22.102	360	130	3

P2222 Expositor bambú con 3 bols /
Bamboo displayer with 3 bowls /
Présentoir bambou avec 3 bols /
Buffetständer Bambus mit 3 Schalen



REF	L mm	Ø mm	H mm	Lts	
P22.220	290	110	35	0,20	6
P22.221	400	130	60	0,50	6
P22.222	495	160	85	1,10	6

P2216 Bol cónico / Conical bowl /
Bol conique / Konische Schüssel



REF	Ø mm	H mm	
P22.167	130	85	6
P22.168	160	108	6

P22003 Bandeja exhibición cuadrada /
Squared display plate /
Plateau carré présentation /
Quadratische Präsentationsplatte



REF	mm	H mm	
P22.0031	310	40	3
P22.003	350	40	3
P22.0033	420	50	3

P22177 Bandeja redonda / Round plate /
Plateau rond / Runder Servierteller



REF	Ø mm	H mm	
P22.177	350	35	3



Bandeja exhibición cuadrada /
Squared display plate /
Plateau carré présentation /
Quadratische Präsentationsplatte

P22002

REF	mm	H mm	
P22.0021	305	35	3
P22.002	355	40	3
P22.0023	405	45	3

Bol cuadrado hondo /
Deep squared bowl /
Bol carré /
Tiefe quadratische Schüssel

P222

REF	mm	H mm	
P22.211	70 x 70	42	24
P22.200	90 x 90	55	12
P22.201	130 x 130	70	6
P22.202*	180 x 180	85	6
P22.203	240 x 240	100	3
P22.204	300 x 300	115	3

P2220 Bol cuadrado hondo dos colores / Two tones deep squared bowl /
Bol carré deux couleurs / *Zweifarbige tiefe quadratische Schüssel*

REF	mm	H mm	Rojo / Red / Rouge / Rot	Azul / Blue / Bleu / Blau	Amarillo / Yellow / Jaune / Gelb	Verde / Green / Vert / Grün	Negro / Black / Noir / Schwarz	
P22.200	90 x 90	55	R	A	AM	V	N	12
P22.202	180 x 180*	85	R	A	AM	V	N	6
P22.203	240 x 240	100	R	A	AM	V	N	3

REF + Codigo color / REF + Color code / REF + Code couleur / REF + Farbcode



Ver productos en / See products on /
Voir produits en page / *Siehe produkte in*

P. 414

* Encaja en expositores CUBIC.

* Fits in CUBIC display.

* Adaptable aux présentoirs CUBIC.

* Anpassbar an dem CUBIC Buffetaussteller.





P2200 Fuente cuadrada / Squared tray /
Plateau carré / Quadratische Schale



REF	A mm	H mm	
P22.001	335	55	3
P22.000	373	28	3

Bandeja exhibición rectangular /
Oblong display tray /

P2208 Plateau rectangulaire /
Quadratische Präsentationsplatte



REF	mm	H mm	
P22.085	390 x 150	15	6
P22.086	500 x 180	18	6

P22099 Plato - bol / Bowl - plate /
Plat - bol / Teller - Schüssel



REF	Ø mm	H mm	
P22.099	380	90	6

P2201 Fuente rectangular / Oblong plate /
Plateau rectangulaire / Quadratische Schale

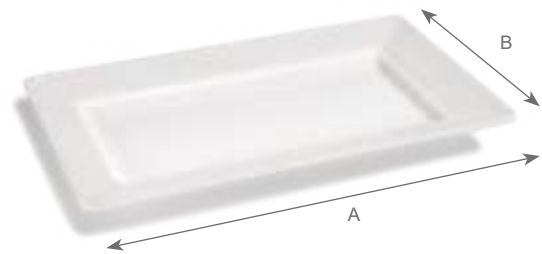

REF	A x B mm	H mm	
P22.012	358 x 205	38	3
P22.013	443 x 221	44	3
P22.014	495 x 272	56	3
P22.015	557 x 322	52	3
P22.016	710 x 405	53	3

P2215 Bandeja gastronorm / Gastronorm tray /
Plateau gastronorme / Gastronormplatte



REF	mm	H mm	
P22.150	530 x 325	20	3
P22.151	325 x 265	20	6

P22004 Bol cuadrado / Deep squared bowl /
Bol carré / Quadratische Schüssel



REF	mm	H mm	
P22.004	250 x 250	88	3
P22.005	375 x 375	90	3



P2211 Plato / Round dish /
Assietteplate / Teller



REF	Ø mm	H mm	
P22.111	160	23	12
P22.112	200	23	12
P22.113	230	23	6
P22.114	265	23	6

P22115 Plato sopa / Soup plate /
Assiette à soupe / Suppenteller



REF	Ø mm	H mm	
P22.115	240	37	6

P22116 Bol grande / Big salad bowl /
Saladier grand / Grosse Schüssel



REF	Ø mm	H mm	
P22.116	190	50	6

P22182 Plato oval / Oval dish /
Assiette ovale / Ovaler Teller



REF	mm	H mm	
P22.182	243 x 182	21	6
P22.183	305 x 232	25	6
P22.184	342 x 268	27	6

P2225 Bol cereales encastable / Stackable bowl / Bol empilable / Stapelbare Müslischüssel



REF	Ø mm	H mm	
P22.250	120	45	12
P22.251	140	55	12

P22117 Bol pequeño / Small salad bowl / Saladier petit / Kleine Schüssel



REF	Ø mm	H mm	
P22.117	140	60	12

P22178 Taza / Cup / Tasse / Tasse Plato / Plate / Assiette / Unterteller



	REF	Size	Ø mm	H mm	Lts	
Taza / Cup / Tasse / Tasse	P22.178	S	70	48	0,10	12
	P22.180	L	98	65	0,25	12
Plato / Plate / Assiette / Unterteller	P22.179	S	103	-	-	12
	P22.181	L	144	-	-	12

P22118 Taza apilable / Stackable mug / Tasse empilable / Stapelbare Tasse



REF	Ø mm	H mm	Lts	
P22.118	75	100	0,30	6

P22033 Cuchara perforada / Slotted spoon / Cuillère ajourée / Gelochter Löffel



REF	L mm	
P22.033	300	24

P22034 Cacillo / Soup ladle / Louche / Schöpflöffel



REF	L mm	Lts	
P22.034	170	0,08	24



P22023 Fuente oval honda / Oval plate /
Plateau ovale / Ovale tiefe Buffetschale



REF	mm	H mm	
P22.023	500 x 360	67	3

P22022 Fuente redonda / Round bowl /
Bol rond / Runde Buffetschüssel



REF	Ø mm	H mm	
P22.022	360	70	3

P22019 Bol redondo / Round bowl /
Bol rond / Runde Schüssel



REF	Ø mm	H mm	
P22.019	200	90	3
P22.020	280	125	3

P22174 Bol redondo inclinado / Slanted round bowl /
Bol rond incliné / Schräge runde Schale



REF	mm	H mm	Lts	
P22.174	212 x 208	104	0,60	6
P22.175	300 x 291	137	1,60	3
P22.176	360 x 349	163	2,85	3

P22090 Plato redondo de presentación /
Round plate presentation /
Plateau rond présentation /
Runder Servierteller



REF	Ø mm	H mm	
P22.090	310	20	4

P22364 Bol redondo / Round bowl /
Bol rond / Runde Schüssel



NEW!

REF	Ø mm	H mm	
P22.364	225	115	3
P22.365	260	140	3



P23990 Bandeja presentación / Displaytray / Plateau présentation / Präsentationsschale

1/1 1/2 1/3 2/4



2/4

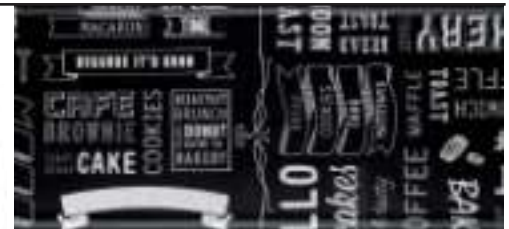

REF	Mod	L mm	H cm	
P23.990	1/1	530 x 325	1,8	12
P23.991	1/2	325 x 265	1,8	24
P23.992	1/3	325 x 176	1,8	36
P23.993	2/4	530 x 162	1,8	24

Ver productos en / See products on /
Voir produits en page / Siehe produkte in

P. 407

Tapas GN transparentes presentación /
Clear GN lids for presentation /
Couvercles GN transparents de présentation /
Transparente GN-Präsentationdeckel



1/3



P22775 Bandeja repostería / Confectionerytray / Plateau à pâtisserie / Gebäckschale



P22.775



P22.779

REF	H cm	cm	H cm	
P22.775	2	36,5 x 29,5	2	1
P22.778	2	36,5 x 29,5	2	1
P22.779	2	36,5 x 29,5	2	1



Exclusiva gama de tablas de melamina donde la apariencia y el tacto hacen que la imitación de roble viejo sea prácticamente perfecta. Para una presentación elegante.

Exclusive range of melamine boards similar to oak thanks to its appearance and its touch. Ideal for a nice presentation.

Gamme exclusive de tablettes de mélamine dont l'apparence et le toucher ressemblent très fortement au bois de chêne. Idéal pour une présentation élégante.

Exclusive serie von melaminplatten, welche durch ihre äussere erscheinung und der oberfläche der rustikalen eiche praktisch perfekt ähnelt. Für eine elegante präsentation.

P22127 Soporte presentación / Display plate / Présentoir / Präsentationsplatte



REF	Ø mm	H cm	
P22.127	230	1,5	1
P22.128	280	1,5	1
P22.129	325	1,5	1

P2265 Pala horno roble / Oven oak peel / Pelle four chêne / Backofenschaufel Eiche



REF	mm	
P22.650	Ø 300	6
P22.651	530 x 200	6
P22.652	610 x 200	6

P2260 Soporte presentación roble / Oak display plate / Présentoir chêne / Präsentationsständer Eiche



1/1 1/2 1/4 1/3 2/4



Con pies antideslizantes
With non-slip feet
Avec pieds antidérapants
Mit Antirutschfüßen

REF	Mod.	mm	
P22.600	1/1	530 x 325	3
P22.601	1/2	325 x 265	6
P22.602	1/3	325 x 176	6
P22.603	1/4	265 x 162	6
P22.604	2/4	530 x 165	6

P2262 Bandeja presentación roble / Oak serving tray / Plateau présentation bois / Eichentablett



REF	mm	H mm	
P22.620	300 x 150	18	12
P22.621	300 x 200	18	12
P22.622	400 x 300	18	6

P2261 Soporte presentación / Display plate / Présentoir / Präsentationsplatte



1/1 1/2 2/4



Con pies antideslizantes
With non-slip feet
Avec pieds antidérapants
Mit Antirutschfüßen

REF + código color
REF + color code
REF + code couleur
REF + Farbcode

REF	Mod.	mm	Blanco / White / Blanc / Weiss	Negro / Black / Noir / Schwarz	
P22.610	1/1	530 x 325	B	N	3
P22.611	1/2	325 x 265	B	N	4
P22.614	2/4	530 x 165	B	N	6

P22664 Soporte presentación madera blanca / White wood serving tray /
Plateau présentation bois blanc / Weiße Holzpräsentationstablett



1/1 1/2 1/4 1/3 2/4





REF	Mod.	L mm	H cm	
P22.660	1/1	530 x 325	1,0	6
P22.661	1/2	325 x 265	1,0	24
P22.662	1/3	325 x 176	1,0	24
P22.663	1/4	265 x 162	1,0	24
P22.664	2/4	530 x 163	1,0	12

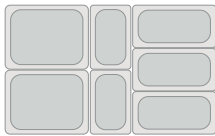

P22690 Soporte presentación pizarra / *Slate display plate /*
Présentoir base ardoise / *Präsentationstablrett/Schiefertafel*

1/2 1/4 1/3



REF	Mod.	L mm	H cm	
P22.690	1/2	325 x 265	1,0	24
P22.691	1/3	325 x 175	1,0	24
P22.692	1/4	265 x 160	1,0	24

P2264 Bandeja base pizarra / *Slate display plate /* Présentoir base ardoise / *Präsentationstablrett/Schiefertafel*

1/2 1/4 1/3



Con pies antideslizantes
With non-slip feet
Avec pieds antidérapants
Mit Antirutschfüßen



REF	Mod.	mm	
P22.640N	1/2	325 x 265	6
P22.641N	1/3	325 x 175	6
P22.642N	1/4	265 x 160	6

P22161 Soporte presentación Pizarra - granito / *Slate - granite Display plate /*
Presentoir Ardoise - granite / *Präsentationsplatte/Schiefer - Granit*

1/1 1/2





Reversible:
1 cara pizarra - 1 cara granito

Reversible:
1 slate side - 1 granite side

Réversible:
1 face ardoise - 1 face granite

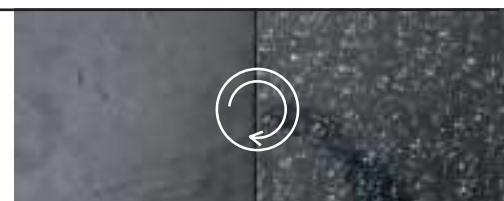
Reversibel:
1 Seite Schiefer - 1 Seite Granit



REF	Mod.	mm	H mm	
P22.161	1/1	530 x 325	7,0	3
P22.162	1/2	325 x 265	7,0	3

P22144 / P22145 Soporte presentación doble cara pizarra - bambú / Double face slate - bamboo display plate / Présentoir double face bambou - ardoise / Zweiseitige Präsentationsplatte Schiefer - Bambus



Reversible:
1 cara pizarra - 1 cara bambú
Reversible:
1 slate side - 1 bamboo side
Réversible:
1 face ardoise - 1 face bambou
Reversibel:
1 Seite Schiefer - 1 Seite Bambus



REF	Ø mm	H mm	
P22.144	330	10	3
P22.145	430	10	3

P22124 Soporte presentación / Display plate / Présentoir / Präsentationsplatte



REF	Ø mm	H cm	
P22.124	230	1,5	1
P22.125	280	1,5	1
P22.126	325	1,5	1

P22695 Soporte presentación mármol / Marble display plate / Présentoir base marbre / Präsentationstablett Marmor



REF	Mod.	L mm	H cm	
P22.695	1/1	530 x 325	20	9
P22.696	1/2	325 x 265	20	12
P22.697	1/3	325 x 176	20	24
P22.698*		150 x 150	95	48

P22361 Bandeja presentación / Display tray / Plateau de présentation / Präsentiertablett



REF	Ø mm	H cm	
P22.361	227	1,5	1
P22.362	278	1,5	1
P22.363	327	1,5	1

GN CLASSIC. COLORS



GN 1/1 530 x 325 mm



Amarillo / Yellow / Jaune / Gelb

REF	H mm	
P22.866	20	6
P22.867	40	3
P22.868	65	2

Naranja / Orange

REF	H mm	
P22.863	20	6
P22.864	40	3
P22.865	65	2

Rojo / Red / Rouge / Rot

REF	H mm	
P22.869	20	6
P22.870	40	3
P22.871	65	2

Gris / Grey / Gris / Grau

REF	H mm	
P22.860	20	6
P22.861	40	3
P22.862	65	2

GN 1/2 325 x 265 mm



Amarillo / Yellow / Jaune / Gelb

REF	H mm	
P22.878	20	6
P22.879	40	3
P22.880	65	2

Naranja / Orange

REF	H mm	
P22.875	20	6
P22.876	40	3
P22.877	65	2

Rojo / Red / Rouge / Rot

REF	H mm	
P22.881	20	6
P22.882	40	3
P22.883	65	2

Gris / Grey / Gris / Grau

REF	H mm	
P22.872	20	6
P22.873	40	3
P22.874	65	2

Ver productos en / See products on /
Voir produits en page / Siehe produktein

P.
395

Tapas GN transparentes presentación /
Clear GN lids for presentation /
Couvercles GN transparentes de présentation /
Transparente GN-Präsentationendeckel



Ver productos en / See products on /
Voir produits en page / Siehe produktein

P.
433

BUF
FET



GN 1/1

530 x 325 mm



REF	H mm	
P22.051	20	6
P22.053	40	3
P22.009	65	2

GN 2/3

353 x 325 mm



REF	H mm	
P22.047	65	3

GN 1/2

325 x 265 mm

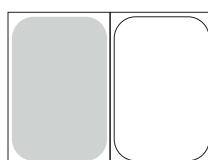

REF	H mm	
P22.039	20	6
P22.041	40	3
P22.010	65	3
P22.084	100	3

GN 2/4

530 x 162 mm



REF	H mm	
P22.049	65	3

GN 1/3

325 x 175 mm

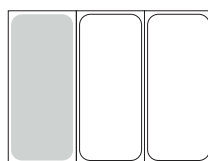

REF	H mm	
P22.011	65	3
P22.080	100	3

GN 1/4

265 x 162 mm

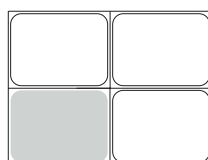

REF	H mm	
P22.043	65	3

GN 1/6

176 x 162 mm

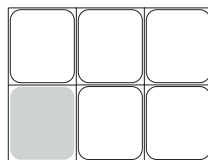

REF	H mm	
P22.045	65	6
P22.082	100	6

13.1 MELAMINA / MELAMINE /
MÉLAMINE / MELAMIN



GN SLIM CUBETA LIGERA / SLIM PAN /
BACLÉGER / LEICHTE BEHÄLTER

**GAMA ECONÓMICA /
ECONOMIC LINE /
GAMME ECONOMIQUE /
ÖKONOMISCHE SERIE**

IDEA! Ideal buffets fríos.
Ideal for cold buffets.
Idéal pour buffets froids
Ideal für kalte Buffets

**Apilable / Stackable /
Empilable / Stapelbar**

1/1 1/2 1/4 1/3 2/4 1/6

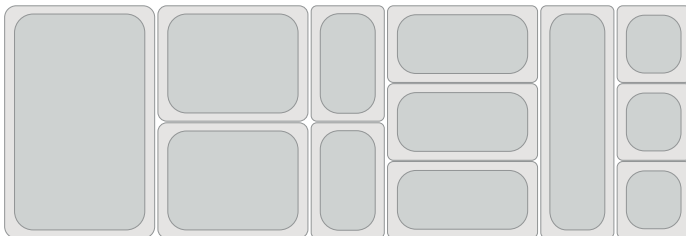

**Estilizada /
Stylized /
Stylisée /
Stilisiert**



CLASSIC
Cubeta tradicional /
Current pan /
Bactraditionnel /
Traditioneller GN-Behälter

GN 1/1 530 x 325 mm



REF	H mm	
P23.030	20	12
P23.031	65	6
P23.032	100	6

GN 1/2 325 x 265 mm



REF	H mm	
P23.033	20	24
P23.034	65	12

GN 2/4 530 x 162 mm



REF	H mm	
P23.044	20	12
P23.045	65	12
P23.046	100	12

GN 1/3 325 x 176 mm



REF	H mm	
P23.036	20	24
P23.037	65	24
P23.038	100	12

GN 1/4 265 x 162 mm



REF	H mm	
P23.039	20	48
P23.040	65	24

GN 1/6 176 x 162 mm



REF	H mm	
P23.042	65	24
P23.043	100	24

GN 1/1

530 x 325 mm



REF	H mm	
P22.052	20	6
P22.054	40	3
P22.006	65	2

GN 2/3

353 x 325 mm



REF	H mm	
P22.048	65	3

GN 1/2

325 x 265 mm



REF	H mm	
P22.040	20	6
P22.042	40	3
P22.007	65	3
P22.083	100	3

GN 2/4

530 x 162 mm

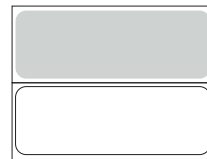

REF	H mm	
P22.087	20	6
P22.050	65	3

GN 1/3

325 x 175 mm

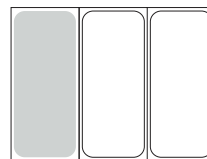

REF	H mm	
P22.094	20	6
P22.008	65	3
P22.079	100	3

GN 1/4

265 x 162 mm



REF	H mm	
P22.044	65	3

GN 1/6

176 x 162 mm

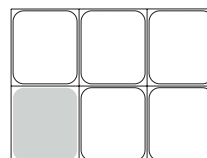

REF	H mm	
P22.046	65	6
P22.081	100	6

P22154 Expositor buffet para cubetas GN 1/1 /
1/1 Gastronorm buffet displayer /
Présentoir buffet pour bacs GN 1/1 /
Buffetständer für GN 1/1 Behälter



Cubetas no incluidas /
Containers not included /
Bacs non inclus /
Behälter nicht inklusive

REF	TIPO/TYPE	mm	H mm	
P22.154	1/1	565 x 525	325	6

P22155 Expositor buffet para cubetas GN 1/2 /
1/2 Gastronorm buffet displayer /
Présentoir buffet pour bacs GN 1/2 /
Buffetständer für GN 1/2 Behälter



Cubetas no incluidas /
Containers not included /
Bacs non inclus /
Behälter nicht inklusive

REF	TIPO/TYPE	mm	H mm	
P22.155	1/2	360 x 525	325	6

P22156 Expositor buffet para cubetas GN 1/3 / 1/3 Gastronorm buffet displayer /
Présentoir buffet pour bacs GN 1/3 / Buffetständer für GN 1/3 Behälter



REF	TIPO/TYPE	mm	H mm	
P22.156	1/3	360 x 525	325	6

Cubetas no incluidas /
Containers not included /
Bacs non inclus /
Behälter nicht inklusive

P22158 Expositor 4 vasijas /
4 Crocks system stand /
Présentoir 4 cruches /
Buffetständer 4 Gefässe



P22.160
Vasijas no incluidas /
Crocks not included /
Cruches pas incluses /
Gefässe nicht inklusive

REF	mm	H mm	
P22.158	190 x 525	325	6

P22160 Vasija 1l / 1l crock /
Cruche 1l / Gefäss 1l



REF	Ø mm	H mm	
P22.160	130	105	6

**P22108**

Platillo cuadrado / *Squared bowl* /
Bol carré / *Quadratisches Tellerchen*



REF	mm	H mm	Lts	
P22.108	100 x 100	33	0,10	24
P22.109	125 x 125	35	0,18	24

P22088

Platillo para huevo / *Egg cup* /
Coquetier / *Eierbecher*



REF	mm	H mm	
P22.088	115 x 115	20	24

P22104

Mini bandeja presentación / *Mini square plate* /
Plateau miniature / *Mini Buffettblett*



REF	mm	H mm	
P22.104	125 x 105	20	24
P22.105	140 x 130	20	24
P22.106	170 x 140	25	24

P867

Recipiente para salsas / *Ramekin* /
Ramequin / *Sossengefäß*



REF	Ø mm	H mm	
P867.030	58	27	12
P867.060	70	37	12
P867.090	78	40	12
P867.120	85	45	12

P22890

Fuente rectangular / *Small tray* /
Ravier rectangulaire / *Rechteckiges Buffettblett*



Apilable / *Stackable* /
Empilable / *Stapelbar*

REF	mm	H mm	
P22.890	130 x 90	20	24

P22110

Cuchara degustación / *Party spoon* /
Cuillère amuse bouche / *Verkostungslöffel*



REF	mm	H mm	
P22.110	145 x 45	50	60



P23840

Cacerola oval / Oval casserole /
Casserole ovale / Ovale Kasserolle

P23.840



P23.841

REF	cm	L cm	H cm	
P23.840	12 x 8	15,5	3,5	96
P23.841	21 x 14	26,5	3,5	96

P23836

Mini cacerola redonda / Mini round casserole /
Mini cocotte ronde / Runder Minikasserolle



REF	Ø cm	L cm	H cm	
P23.835	11,5	15	3,5	96
P23.836	14,5	19	3,5	96

P23830

Mini parrilla con asas / Mini hot plate with handles /
Mini grill avec poignées / Mini Bratplatte mit Griffen



REF	cm	L cm	H cm	
P23.830	26 x 16	32	2,0	96

P23824

Mini sartén cuadrada / Mini squared fry pan /
Mini poêle carrée / Quadratische Minibratpfanne



REF	cm	L cm	H cm	
P23.824	12,5 x 10,5	16	2,0	96

P23825

Mini sartén redonda / Mini round fry pan /
Mini poêle ronde / Runder Minibratpfanne



REF	Ø cm	L cm	H cm	
P23.825	11	16	3,0	96

P23800

Mini cacerola con tapa / Mini round casserole with lid /
Mini cocotte avec couvercle / Minikasserolle mit Deckel



P23.810

P23.800

Ver colores en /
See colors on /
Voir couleurs
en page /
Siehe Farben in

P.
360

REF	Ø cm	H cm	L cm	
P23.800	10	6,5	0,25	1
P23.810	14	8,0	0,75	1

P23842 Mini cacerola / Mini casserole /
Mini cocotte / Minikasserolle

REF	Ø cm	H cm	
P23.842	9	4,5	1

P23843 Mini cacerola oval / Mini oval casserole /
Mini cocotte ovale / Mini Ovale Kasserolle

REF	cm	H cm	
P23.843	18 x 13	4,0	1

P23844 Mini cacerola rectangular /
Mini rectangular casserole /
Mini casserole rectangulaire /
Mini Rechteckiges Kasserolle

REF	cm	H cm	
P23.844	19,5 x 10	5,0	1

P23845 Mini sartén redonda /
Mini round fry pan /
Mini poêle ronde /
Runder Minibratpfanne

REF	Ø cm	L cm	H cm	
P23.845	21,5	30,5	3,0	1

P22120 Bandeja snacks o salsas /
Snacks or sauce tray /
Plateaux sauces /
Schale für Snacks oder Sossen

REF	cm	H cm	
P22.120	17,5 x 8,5	3,5	1

P2293 Bandeja snacks o salsas /
Snacks or sauce tray /
Plateaux sauces /
Schale für Snacks oder Sossen

REF	mm	H mm	
P22.920	190 x 80	30	12
P22.930	92 x 69	31	24

P22035 Cenicero cuadrado. Negro /
Squared ashtray. Black /
Cendrier carré. Noir /
Quadratische Aschenbecher. Schwarz



REF	cm	H cm	
P22.035	9 x 9	3,0	1

P22036 Cenicero redondo. Negro /
Round ashtray. Black /
Cendrier rond. Noir /
Runder Aschenbecher. Schwarz



REF	Ø cm	H cm	
P22.036	10	4,5	1

P22030 Cenicero redondo con tapa. Negro /
Windproof ashtray round with lid. Black /
Cendrier pour l'extérieur avec couvercle. Noir /
Runder Aschenbecher mit Deckel. Schwarz



REF	Ø cm	H cm	
P22.030	14,5	6,0	6

P22031 Cenicero redondo. Negro /
Round dinner ashtray. Black /
Cendrier rond. Noir /
Runder Aschenbecher. Schwarz



REF	Ø cm	H cm	
P22.031	10	5,0	12

P22185 Cenicero cónico melamina. Negro / *Conical melamine ashtray. Black /*
Cendrier conique. Noir / *Konischer Aschenbecher. Schwarz*



REF	Ø cm	H cm	
P22.185	10	2,7	24



BUFFET Y ACCESORIOS /
BUFFET & ACCESSORIES /
BUFFET ET ACCESSOIRES /
BUFFET UND ZUBEHÖR

14.1	PROTECCIÓN Y TAPAS / <i>PROTECTION AND COVERS /</i> PROTECTION ET COUVERCLES / <i>SCHUTZ UND DECKEL</i>	392
14.2	COOL · LINE COLLECTION	396
14.3	SUPER SHAPES CUBETAS PRESENTACIÓN BUFFET / <i>BUFFET PRESENTATION STEAM TABLE PANS /</i> BACS PRÉSENTATION BUFFET / <i>BUFFET PRÄSENTATION DAMPFBEHEIZTE WANNEN</i>	398
14.4	MIRAMAR® COOKWARE BATERÍA DE COCINA PARA PRESENTACIÓN / <i>DISPLAY COOKWARE /</i> BATTERIE DE CUISINE-PRÉSENTATION / <i>PRÄSENTATIONS-KOCHGESCHIRR</i>	402
14.5	CUBIC	408
14.6	PRESENTACIÓN Y EXPOSITORES / <i>DISPLAY STANDS & DISPLAY BASKETS /</i> PRÉSENTOIRS ET PRÉSENTOIRS CORBEILLES / <i>PRÄSENTATIONSSTÄNDER DISPLAY-KÖRBE</i>	432
14.7	CHAFINGS Y DISPENSADORES / <i>CHAFERS & DISPENSERS /</i> CHAFERS ET DISTRIBUTEURS / <i>CHAFERS & SPENDER</i>	436
14.8	BOLS DOBLE PARED / DOUBLE WALL BOWLS / BOLS DOUBLE PAROI / DOPPELWANDIGE SCHALEN	444
14.9	BANDEJAS DE SERVICIO / SERVING TRAYS / PLATEAUX / SERVIERTABLETTS	448
14.10	UTENSILIOS DE SERVICIO / SERVING TOOLS / USTENSILES DE SERVICE BUFFET / SERVIERBESTECK	450
14.11	SEÑALIZACIÓN / SIGNS / SIGNALIZATION / MARKIERUNG	460

P19060 Protección Anti-aliento regulable / Mobile and adjustable breath guards /
Pare-haleine ajustable / Verstellbare Atemschutzplatte

REF	cm	
P19.060	60 x 45 x 38	1
P19.090	90 x 45 x 38	1
P19.120	120 x 45 x 38	1

Ajustable en inclinación y altura para adaptarse a diferentes espacios. Protege los alimentos expuestos sin perder visibilidad.

Adjustable in tilt and height to adapt to different spaces. Protect exposed foods without losing visibility.

Hauteur et inclinaison réglables pour s'adapter à tous les espaces des buffets. Protège et laisse visible les aliments exposés.

Neigung und Höhe einstellbar zur Anpassung an unterschiedliche Räume. Schützt ausgestellte Speisen, ohne deren Sichtbarkeit zu verringern.

MBA92821Protección acrílica Anti-aliento / Mobile Acrylic Breath Guards /
Pare-haleine mobiles en acrylique / Mobile Acryl-Atemschutzplatten

REF	cm	
MBA92821	121,9 x 49,5 x 40,6	1

Solución para cubrir superficies de alimentos. Paneles acrílicos de 1 cm de grosor. Duradero. De fácil montaje y transporte.

Convenient, durable and portable solution to cover food serving areas. Folds down flat and secures with magnetic latches - for ease in transporting. 1 cm thick acrylic panels can be securely fastened in place with easy thumb turns.

Solution pratique, durable et portable pour couvrir les zones de service des aliments.

Praktische, haltbare und tragbare Lösung zur Abdeckung von Speisen-Servierbereichen.



Bolsa de nylon incluida.

Nylon bag included.

Sac en nylon compris.

Nylontasche nicht enthalten.



P590008 Tapa campana / Dome cover /
Couvercle cloche / Glocke

Policarbonato.
Polycarbonate.
Polycarbonate.
Polycarbonat.



NEW!

REF	Ø cm	H cm	
P59.0008	21	17,5	1
P59.0009	26	20	1
P59.0010	31	23,5	1

P22361 Bandeja presentación / Display tray /
Plateau présentation / Präsentationschale



NEW!

REF	Ø cm	H cm	
P22.361	22,7	1,5	1
P22.362	27,8	1,5	1
P22.363	32,7	1,5	1

P590011 Tapa con visagra / Hinged cover /
Couvercle articulé / Deckel mit Scharnier

Acrílico
Acrylic
Acrylique
Acryl



NEW!

REF	Ø cm	
P59.0011	23,0	1
P59.0012	26,5	1

P22364 Bol / Bowl / Bol / Schüssel



NEW!

REF	Ø cm	
P22.364	22,5	1
P22.365	26,0	1



P59.0008 + P22.361
P59.0009 + P22.362
P59.0010 + P22.363



P59.0011 + P22.364
P59.0012 + P22.365



Tapa redonda transparente presentación /
Clear round lid for presentation /
Couverclerond transparent pour présentation /
Transparent Präsentationsdeckel

P598700

Policarbonato.
Polycarbonate.
Polycarbonate.
Polycarbonat.



REF	Ø cm	H cm	
P598.700	22	13,5	1
P598.800	27	16,5	1

Vitrina redonda /
Round display cabinet /
Vitrine ronde /
Auslagevitrine, rund

P590005

Plástico / Plastic /
Plastique / Plastik



REF	cm	H cm	Base útil / Functional basic / <i>Base utile / Nützliche grundausrüstung</i> cm	
P590.005	38	22	Ø 31,5	1
P590.006	46	26	Ø 37,5	1

Vitrina rectangular /
Rectangular display cabinet /
Vitrine rectangulaire /
Auslagevitrine, rechteckige

P590001

Plástico / Plastic /
Plastique / Plastik



REF	cm	H cm	Base útil / Functional basic / <i>Base utile / Nützliche grundausrüstung</i> cm	
P590.001	40 x 24,5	15,5	34 x 19	1
P590.002	50,5 x 30,5	18,0	44 x 24,5	1

Vitrina doble /
Double display cabinet /
Vitrine double /
Doppel-Auslagevitrine

P590003

Plástico / Plastic /
Plastique / Plastik



REF	cm	H cm	Base útil / Functional basic / <i>Base utile / Nützliche grundausrüstung</i> cm	
P590.003	40 x 24,5	32	2 x (34 x 19)	1
P590.004	50,5 x 30,5	40	2 x (44 x 24,5)	1

P904300 Tapa roll-top / Roll-top lid / Couvercle roll-top / Rolldeckel

1/1



REF	Mod	mm	H mm	
P904.300	1/1	570 x 325	175	1

Polycarbonato.
 Polycarbonate.
 Polycarbonate.
 Polycarbonat.

P590110 Tapas GN transparentes presentación / Clear GN lids for presentation /
 Couvercles GN transparentes de présentation / Transparente GN-Präsentationdeckel

1/1 1/2 1/3 2/4



REF	Mod	H cm	
P590.110	1/1	10	6
P590.120	1/2	10	12
P590.130	1/3	10	18
P590.240	2/4	10	12

Polycarbonato.
 Polycarbonate.
 Polycarbonate.
 Polycarbonat.

COMPATIBLE CON /
SUITABLE FOR /
ADAPTABLE POUR /
GEEIGNET FÜR



P834 Tapa rectangular GN / GN rectangular lid /
 Couvercle rectangulaire GN / Rechteckiger GN Deckel

1/1



Polycarbonato.
 Polycarbonate.
 Polycarbonate.
 Polycarbonat.

REF	Mod.	mm	H mm	
P834.000	1/1	530 x 325	100,0	1

P835 Campana GN / GN dome lid /
 Dôme de protection GN / GN Haube

1/1



Polycarbonato.
 Polycarbonate.
 Polycarbonate.
 Polycarbonat.

REF	Mod.	mm	H mm	
P835.000	1/1	530 x 325	190,0	1

COOL • LINE COLLECTION



P4909 Paellera con tapa / Paella pan with lid / Plat à paella avec couvercle / Paellapfanne mit Deckel



EXCLUSIVE



REF	Ø cm	H cm	Lts	
P490.928 + COLOR	28	6,0	3,70	1
P490.932 + COLOR	32	6,0	4,70	1

Ref. color / Ref. colour /
 Ref. couleur couvercle / Art.Nr. Farben



Ver productos en / See products on /
 Voir produits en page / Siehe produktein

P.
49

BATERÍA DE COCINA / COOKWARE /
BATTERIEDE CUISINE / KOCHBEDARF



Ver productos en / See products on /
 Voir produits en page / Siehe produktein

P.
65

SARTENES / FRY PANS /
POÊLES / PFANNEN



COOL • LINE COLLECTION

COOL • LINE
COLORS



Ref. color /
Ref. colour /
Ref. couleur couvercle /
Art.Nr. Farben

PATENTED **EXCLUSIVE**

P1106F3 Cubeta GN antiadherente con fondo difusor / Non-stick sandwich bottom GN container / Bac GN anti-adhésive avec fond thermo-diffuseur / GN Behälter Antihaft mit Sandwichboden



INOX - ST/STEEL
EDELSTAHL
18/10



Ideal para presentación buffet.
Ideal for buffet presentations.
Idéal pour présentation buffet.
Ideal für buffet präsentation.

REF	Tipo Type	H mm	Lts	
P110.6F3A	1/1	65	8,30	1
P110.6F3N	1/1	65	8,30	1
P110.6F3R	1/1	65	8,30	1
P110.6F3G	1/1	65	8,30	1
NEW! P110.6F3	1/1	65	8,30	1
P120.6F3A	1/2	65	4,10	1
P120.6F3N	1/2	65	4,10	1
P120.6F3R	1/2	65	4,10	1
P120.6F3G	1/2	65	4,10	1
NEW! P120.6F3	1/2	65	4,10	1

P110.6F3A



P110.6F3N



P110.6F3R



P110.6F3G



P110.6F3



Ver productos en / See products on / Voir produits en page / Siehe produkte in

P.
380

**MELAMINA / MELAMINE /
MÉLAMINE / MELAMIN**



BUFFET ACCESSORIES /
BUFFET ACCESSOIRES /
BUFFET ACCESSOIRES

SUPER SHAPES



PATENTED / EXCLUSIVE

Presentación de las comidas en chafers, líneas buffet calientes o fríos, vitrinas de presentación y más.

Presentation of food in chafers, heated or refrigerated buffet lines, display cases, and more.

Présentation des plats dans les chafers, les lignes de buffet chauffées ou réfrigérées, les présentoirs et bien plus encore.

Eine kosteneffektive methode zur eleganteren darstellung von speisen in rechauds, beheizten oder gekühlten büffets, vitrinen und mehr.

Referencia Barra adaptadora / Adaptor Bar Reference /
Référencebarre intermédiaire / Adapterschiene

75015 75013

2/4

1/2

1/3

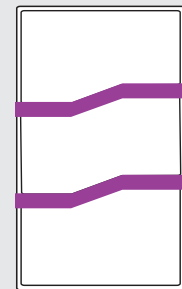
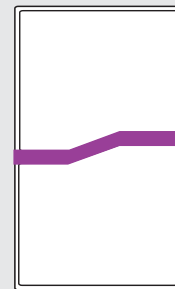
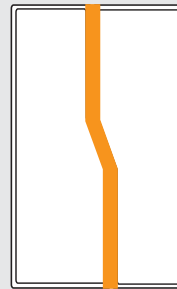

Apilable / Stackable /
Empilable / Stapelbar



3101015 Ovalada / Full Oval / Ovale / Oval, volle Größe

1/1

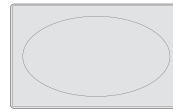

REF	mm	H mm	L	
3101015	530 x 325	51	3,7	6
3101020	530 x 325	65	4,6	6
3101040	530 x 325	100	7,8	6

3102015 Óvalo / Half Oval / Ovale / Oval, halbe Größe

1/2



REF	mm	H mm	L	
3102015	265 x 325	51	1,6	6
3102020	265 x 325	65	2,1	6
3102040	265 x 325	100	3,5	6

3101220 Hexágono / Full Hexagon / Hexagonal / Sechseckige

1/1



REF	mm	H mm	L	
3101220	530 x 325	65	5	6
3101240	530 x 325	100	8,8	6

3102220 Hexágono / Full Hexagon / Hexagonal / Sechseckige

1/2



REF	mm	H mm	L	
3102220	265 x 325	65	2,1	6

3101120 Reniforme / Full Kidney / Rein / Niere, volle Größe

1/1



REF	mm	H mm	L	
3101120	530 x 325	65	4,8	6

CUBETAS PRESENTACIÓN BUFFET /
BUFFET PRESENTATION STEAM TABLE PANS /
BACS PRÉSENTATION BUFFET /
BUFFET PRÄSENTATION DAMPFBEHEIZTE WANNEN**3102120** Reniforme / Half Kidney / Rein / Niere, halbe Größe

1/2



REF	mm	H mm	L	
3102120	265 x 325	65	2,1	6

3100020 Wild Pan larga / Long Wild Pan / Wild Pan long / Lange Wild Pan

2/4



REF	mm	H mm	L	
3100020	530 x 165	65	3,5	6
3100040	530 x 165	89	4,8	6

75015

3100220 Wild Pan corta / Short Wild Pan / Wild Pan court / Kurze Wild Pan

1/2



REF	mm	H mm	L	
3100220	265 x 325	65	3,9	6
3100240	265 x 325	100	6,1	6

75013

3100320 Wild Pan externa / Third Outer Wild Pan /
Troisième Wild Pan extérieur / Wild Pan, Drittelgröße, außen

1/3



REF	mm	H mm	L	
3100320	176 x 325	65	2,5	6
3100340	176 x 325	100	3,6	6

75013

3100321 Wild Pan interna / Inner Wild Pan /
Troisième Wild Pan intérieur / Wild Pan, Drittelgröße, innen

1/3



REF	mm	H mm	L	
3100321	176 x 325	65	2,5	6
3100341	176 x 325	100	3,6	6

75013

75015 Barra adaptadora / Adaptor Bar / Barre intermédiaire / Adapterschiene

REF	Para / For / Pour / Für	
75015	3100020 / 3100040	12
75013	3100220 / 3100240 / 3100320 3100321 / 3100340 / 3100341	12

Ver productos en / See products on / Voir produits en page / Siehe produkte in

P.
198

GN INOX



Ver productos en / See products on / Voir produits en page / Siehe produkte in

P.
201

POLINORM®



BUFFET Y ACCESORIOS /
BUFFET & ACCESSORIES /
BUFFET ET ACCESSOIRES

MIRAMAR® COOKWARE

BATERÍA DE COCINA PARA PRESENTACIÓN /
DISPLAY COOKWARE /
BATTERIE DE CUISINE DE PRÉSENTATION /
KOCHGESCHIRR ZUR PRÄSENTATION



La batería pasa directamente de la cocina a su buffet en el mismo recipiente.
Variedad de utensilios de cocina para todo tipo de comidas.

Cookware goes straight from the kitchen to your buffet in the same vessel.
Variety of cookware items or any menu.

Passez directement de la cuisine au buffet sans changer de plat.
Variété d'articles pour tout type de menu.

Das Kochgeschirr kommt im selben Behälter direkt aus der Küche zum Bankett.
Auswahl an Kochbehältern für jede Art von Menü.





INDUCTION



gas



vitro



electric



oven

Asas y mangos brillantes /
Satin-finished interior and exterior /
Des poignées ultra-brillantes /
Mit glänzenden griffen



**Mangos diseñados para la
sujeción de las tapas /**

*Handle design serves as a
convenient cover rest /*

*La conception des manches et
poignées sert de reposecouvercle /*

*Das design des griffs
ermöglicht bei die praktische
verwendung als deckelhalter*

Interior y exterior satinados /
Mirror-finished handles /
Finition satinée à l'intérieur et l'extérieur /
Einzelne teile des kochgeschirrs innen und außen satiniert



Multimetal / Multi-ply /
Multi-metal / Multimetal

Inox - St/Steel
Rostfreier stahl

Tri-aluminium

Inox - St/Steel
Rostfreier stahl



49410

Cacerola baja con tapa / Casseroles /

Faitouts avec couvercle dôme bas / Kasserolle mit Flachhaubendeckel



REF	mm	H mm	L	
49410	200 x 200	95	2,9	1
49411	241 x 241	113	4,8	1

49420

Fuente para gratinar / Oval Au Gratin / Plat à gratin ovale / Ovale Gratin-Pfanne



49420



49412

REF	mm	H mm	L	
49420	254 x 191	52	1,7	1
49412*	305 x 216	51	2,5	1

*Acabado brillante / Mirror-finished interior /
Ultra-brillant / Durchgängige Hochglanzausführung

49413

Sartén / Sauté Pan / Sauteuse / Sautierpfanne



REF	mm	H mm	L	
49413	260 x 260	48	2,1	1

49417

Paellera / French Omelet Pans / Poêle à omelette / Omelettpfanne



49417



49424

REF	mm	H mm	L	
49417	203 x 203	60	1,7	1
49424	260 x 260	60	2,9	1

49418

Sautex bombeado / Stir Fry Pan / Wok/plat de service / Anbratpfanne



49418



49428

REF	mm	H mm	L	
49418	302 x 302	94	4,9	1
49428	321 x 321	92	6,0	1

49425 Cacerola baja / Brazier Pan / Plat à braiser / Schmorpfanne



REF	mm	H mm	L	
49425	300 x 300	89	6	1

49430 Cazo / Sauce Pans / Casserole / Kochpfann



REF	mm	H mm	L	
49414	159 x 159	95	1,9	1

49434 Fuente / Food Pans / Plat / Speisenpfanne



REF	mm	H mm	L	
49435	291 x 236	51	2,6	1
49433	373 x 300	51	4,4	1

49431 Fuente Horno con tapa / French Oven with cover / Cocotte avec couvercle / Gusseisentopf mit Deckel



REF	mm	H mm	L	
49431	363 x 282	97	6,6	1

49429 Tapa / Covers / Couvercles / Deckel



49429



49419

REF	Para / For / Pour / Für	mm	H mm	
49429	49428	356 x 356	120	1
49426	49418 - 49425	324 x 324	102	1
49419	49417	203 x 203	51	1
49423	49413 - 49424	273 x 273	51	1



PLANTILLAS / TEMPLATES / GABARITS/ SCHABLONEN

Acero inox. / Stainless Steel Plain / Inox / Edelstahl
 Resina / Resin / Résine/ Duroplastauführung
 Negro / Night Sky / Bleu nuit / Nachthimmel  +150°C

8242014 Plantilla agujeros redondo grande y pequeño / One large and one small round / Une grande découpe ronde et une petite découpe ronde / Ein großer und ein kleiner, runder Ausschnitt

1/1





REF	mm		
8242014	536 x 324		1
8242010	536 x 324		1

8242314 Plantilla agujero oval grande / One large oval / Une grande découpe ovale / Ein großer, ovaler Ausschnitt

1/1





REF	mm		
8242314	536 x 324		1
8242310	536 x 324		1

8242414 Plantilla agujeros redondo grande y pequeño / One large round and one small round / Une grande découpe ronde et une petite découpe ronde / Ein großer, runder und ein kleiner, runder Ausschnitt

1/1





REF	mm		
8242414	536 x 324		1

8242514 Plantilla agujeros redondos grandes / Two large round / 2 grandes découpes rondes / 2 große, runde Ausschnitte

1/1





REF	mm		
8242514	536 x 324		1

8242614 Plantilla agujero redondo grande / One large round / Une grande découpe ronde / Ein großer, runder Ausschnitt

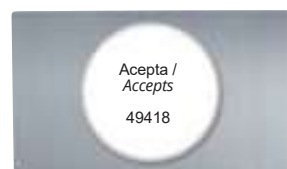
1/1





REF	mm		
8242614	536 x 324		1
8242610	536 x 324		1

8242714 Plantilla agujero oval grande / One large oval / Un grand ovale / Ein großes Oval

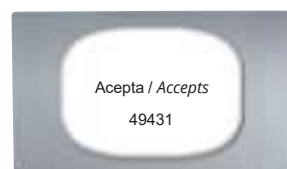
1/1



REF	mm		
8242714	536 x 324		1
8242710	536 x 324		1

PLANTILLAS / TEMPLATES / GABARITS/ SCHABLONEN



Acero inox. / *Stainless Steel Plain / Inox / Edelstahl*
 Resina / *Resin / Résine / Duroplastauführung*
 Negro / *Night Sky / Bleu nuit / Nachthimmel*  **+150°C**



8242814 **Plantilla para fuente / One small food pan /**
 Un petit bac à aliments / *Eine kleine Speisenschale*

1/1





REF	mm		
8242814	536 x 324		1
8242810	536 x 324		1

8242914 **Plantilla para fuente / One large food pan /**
 Un grand bac à aliments / *Eine grosse Speisenschale*

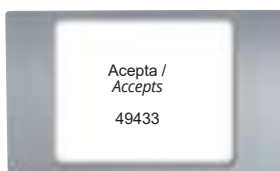
1/1





REF	mm		
8242914	536 x 324		1

8243014 **Plantilla para fuente / Two small food pans /**
 Deux petits bacs à aliments / *Zwei kleine Speisenschalen*

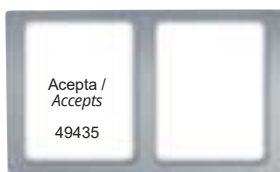
1/1





REF	mm		
8243014	536 x 324		1

8243114 **Plantilla agujeros ovals grande y pequeño / One large and one medium oval /**
 Une grande découpe ronde et une moyenne découpe ovale / *Ein großer und ein mittelgroße, ovaler Ausschnitt*

1/1





REF	mm		
8243114	536 x 324		1

8243214 **Plantilla agujeros redondos medianos / Two medium oval /**
 Deux découpes ovales moyennes / *Zwei mittelgroße, ovale Ausschnitte*

1/1





REF	mm		
8243214	536 x 324		1
8243210	536 x 324		1

8243314 **Plantilla agujeros redondos grande y mediano / One large and one medium round /**
 Une grande découpe ronde et une moyenne découpe ronde / *Grosse runde Löcher Vorlage*

1/1



REF	mm		
8243314	536 x 324		1

CUBIC®



Descubre la mejor presentación de buffet, porque:
Es elegante, es original, ahorra espacio, ofrece múltiples y variadas combinaciones.

Discover the best buffet display, thanks to its:
Elegance, originality, space saving properties, multi-combinations.

EXCLUSIVE

PATENT PENDING



Découvrez la meilleure présentation buffet, grâce à son :
Élégance, originalité, gain d'espace,
multiples combinaisons possibles.

*Entdecken Sie die beste Buffet-Präsentation:
Eleganz, Originalität, Platzsparend, Viele
verschiedene Kombinationsmöglichkeiten.*

Muebles presentación buffet / Display buffet cases / Meubles présentation buffet / Buffet Präsentationsmöbel

**Dos colores disponibles:
 Blanco y negro /**

*Two colors available:
 White and black /*

*Deux couleurs disponibles:
 Blanc et noir /*

*In zwei farben lieferbar:
 Schwarz und weiss*

Adaptado a medidas gastronorm /
Suitable for gastronorm sizes /
Adaptés aux mesures gastronorme /
Geeignet für gastronormgrößen



**Fabricados en madera con
 tratamiento hidrófugo
 especial, de fácil limpieza /**

*Made of wood with special
 waterproof treatment, easy to
 clean /*

*Fabriqué en bois avec un
 traitement hydrofuge spécial,
 facile à nettoyer /*

*Hergestellt aus holz, speziell
 wasserabweisend behandelt,
 einfach zu reinigen*

Carro madera presentación buffet / Wooden buffet serving trolley / Chariot buffet en bois présentation buffet / Buffetservierwagen aus Holz

Elegante combinación de madera y aluminio /
Outstanding combination of wood and aluminium /
Combinaison élégante en bois et en aluminium /
Elegante kombination aus holz und aluminium

**Adaptado a medidas
 gastronorm /**

*Suitable for gastronorm
 sizes /*

*Adaptés aux mesures
 gastronorme /*

*Geeignet für
 gastronormgrößen*

**Tratamiento hidrófugo
 especial, de fácil limpieza /**

*Wood with special waterproof
 treatment, easy to clean /*

*Bois avec un traitement
 hydrofuge spécial, facile à
 nettoyer /*

*Spezielle wasserabweisende
 behandlung, einfach zu reinigen*



**Posibilidad de convertir el
 carro expositor en mesa
 de presentación /**

*Possible transformation
 from an expositor trolley to a
 presentation table /*

*Possibilité de transformer le
 chariot d'exposition en une
 table de présentation /*

*Möglichkeit den buffetwagen
 in einen präsentationstisch zu
 verwandeln*

Cubos y estantes / Cubes & shelves / Cubes et tablettes / Behälter und Regale

EXCLUSIVE

PATENT PENDING



CUBO

Con tapa superior transformable en mini estante, apilables entre sí, múltiples combinaciones posibles, ahorro de espacio durante el almacenaje de las piezas, tratamiento hidrófugo especial.

CUBES

Couvercle transformable en mini rayon, empilables, multiples combinaisons possibles, gain d'espace pour le stockage des composants, traitement hydrofuge spécial.

CUBES

Top cover convertible on mini shelf, stackable, multicombinations, saving space when storing parts, special waterproof treatment.

BEHÄLTER

Mit Deckeloberteil umwandelbar in ein Miniregal, stapelbar. Viele verschiedene Kombinationsmöglichkeiten, platzsparend bei Lagerung der Teile, spezielle Wasserabweisende Behandlung.



ESTANTES

Tres longitudes: 50, 80 y 100 cm, dos profundidades: 18 y 35 cm, madera indeformable, dos colores: blanco y negro. Posibilidad de combinación de colores, tratamiento hidrófugo especial.

TABLETTES

Trois longueurs: 50, 80 et 100 cm, deux profondeurs: 18 et 35 cm. Bois indéformable, deux couleurs: blanc et noir. Combinaison de couleurs possible, traitement hydrofuge spécial.

SHELVES

Three lengths: 50, 80 and 100 cm, two depths: 18 and 35 cm, undeformable wood, two colors: white and black. Possibility of color combinations, special waterproof treatment.

REGALE

Drei Längen: 50, 80 und 100 cm., Zwei Tiefen: 18 und 35 cm. Unverformbares Holz, zwei Farben: weiss oder schwarz. Möglichkeit der Farbkombinierung, spezielle wasserabweisende Behandlung.

EXCLUSIVE

PATENT PENDING

Máxima versatilidad para tus buffets /
Maximum versatility for your buffets /
Versatilité optimum pour vos buffets /
Maximale Vielfältigkeit ihrer Buffets

Con Cubic, ahora es el producto que se adaptā a sus necesidades /
With Cubic, you now have the product that adapts to your needs /
Avec Cubic, c'est dorénavant le produit qui s'adapte à vos besoins /
Mit Cubic haben Sie jetzt das Produkt, welches sich Ihren Bedürfnissen anpasst





Mayor comodidad y funcionalidad /
Greater convenience and functionality /
Plus pratique et plus fonctionnel /
Höherer komfort und funktionalität

Bandejas apilables entre sí /
Stackable trays /
Plateaux empilables entre eux /
Stapelbare tablett



Modularidad a la máxima expresión /
Modularity that reflects maximum expression /
Modularité à son expression maximale /
Modulvielfalt für den maximalen ausdruck

· **Permite optimizar espacio de exposición**
· **Reduce el tiempo de montaje y desmontaje**
· **Facilidad de transporte y almacenaje /**

· *Allows you to maximize display space*
· *Reduces assembly and disassembly time*
· *Easy transportation and storage /*

· *Permet d'optimiser l'espace d'exposition*
· *Réduit le temps de montage et de démontage*
· *Facilité de transport et entreposage /*

· *Optimiert den platz der präsentation*
· *Reduzierung der aufbau- und abbauzeit*
· *Einfacher transport und lagerung*



Personalización del buffet /
Personalise your buffet /
Personnalisation du buffet /
Personalisierung des buffets

Con los soportes de metacrilato se puede identificar el contenido de cada uno de los recipientes, de una forma ágil y elegante /

Methacrylate supports allow you to identify the contents of each container, in an agile and elegant way /

Grâce aux supports en méthacrylate on peut identifier le contenu de chacun des récipients de façon rapide et élégante /

Mit den ständern aus metaakrylat können sie den inhalt jedes einzelnen behälters identifizieren, in einer geschickten und eleganten art und weise



P905.504 Conjunto soporte 4 bols cuadrados / Presentation kit for 4 square bowls /
Kit support 4 bols carrés / Ständerset mit 4 quadratischen Schalen

REF



P905.504

1

Incluye / Includes / Inclus / Inklusive:

2 cubos con tapa
1 travesaño de 50 cm
1 presentador de 4 bols
4 bols de melamina.

2 cubes with lid
1 crossbar 50 cm length
1 displayer for 4 bowls
4 melamine bowls.

2 cubes avec couvercle
1 longeron 50 cm
1 présentoir pour 4 bols
4 bols mélamine.

2 Behälter mit Deckel
1 Traverse von 50 cm
1 Halter für 4 Schalen
4 Schalen aus Melamin.

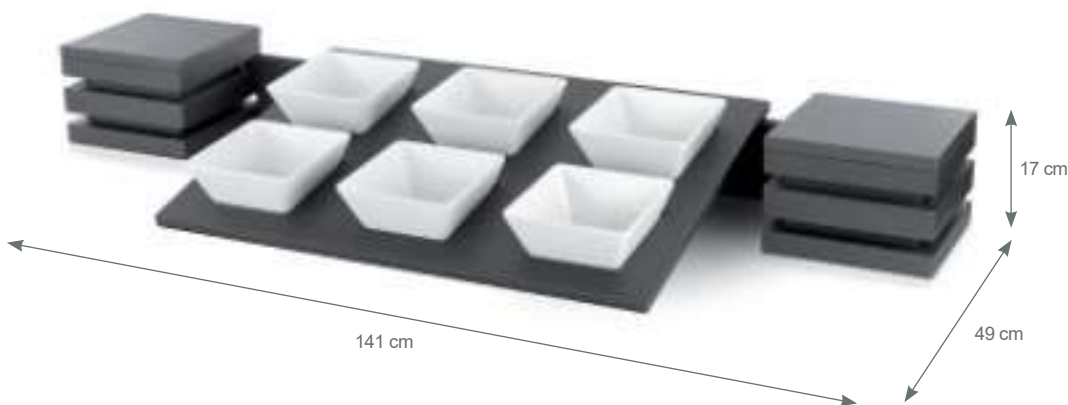
P905.506 Conjunto soporte 6 bols cuadrados / Presentation kit for 6 square bowls /
Kit support 6 bols carrés / Ständerset mit 6 quadratischen Schalen

REF



P905.506

1

Incluye / Includes / Inclus / Inklusive:

2 cubos con tapa
1 travesaño de 100 cm
1 presentador de 6 bols
6 bols de melamina.

2 cubes with lid
1 crossbar 100 cm length
1 displayer for 6 bowls
6 melamine bowls.

2 cubes avec couvercle
1 longeron 100 cm
1 présentoir pour 6 bols
6 bols mélamine.

2 Behälter mit Deckel
1 Traverse von 100 cm
1 Halter für 6 Schalen
6 Schalen aus Melamin.

P905.516 Conjunto 2 niveles soporte 6 bols / Two levels presentation kit for 6 square bowls
Kit support 6 bols carrés deux niveaux / 2 Ebenen Ständerset mit 6 quadratischen Schalen

REF



P905.516

1

Incluye / Includes / Inclus / Inklusive:

4 cubos con tapa
1 travesaño de 100 cm
1 presentador de 6 bols
6 bols de melamina
1 estante estrecho de 100 cm.

4 cubes with lid
1 crossbar 100 cm length
1 displayer for 6 bowls
6 melamine bowls
1 narrow shelf 100 cm.

4 cubes avec couvercle
1 longeron 100 cm
1 présentoir pour 6 bols
6 bols mélamine
1 tablette étroite 100 cm.

4 Behälter mit Deckel
1 Traverse von 100 cm
1 Halter für 6 Schalen
6 Schalen aus Melamin
1 schmales Regal von 100 cm.

P905.508 **Conjunto soporte 8 bols cuadrados / Presentation kit for 8 square bowls /**
 Kit support 8 bols carrés / Ständerset mit 8 quadratischen Schalen



REF 

P905.508 1

Incluye / Includes / Includ / Inklusive:

2 cubos con tapa
1 travesaño de 80 cm
2 presentadores de 4 bols
8 bols de melamina.

2 cubes with lid
1 crossbar 80 cm length
2 displays for 4 bowls
8 melamine bowls .

2 cubes avec couvercle
1 longeron 80 cm
2 présentoirs pour 4 bols
8 bols mélamine.

2 Behälter mit Deckel
1 Traverse von 80 cm
1 Halter für 4 Schalen
8 Schalen aus Melamin.

P905.518 **Conjunto 2 niveles soporte 8 bols / Two levels presentation kit for 8 square bowls /**
 Kit support 8 bols carrés deux niveaux / 2 Ebenen Ständerset mit 8 quadratischen Schalen



REF 

P905.518 1

Incluye / Includes / Includ / Inklusive:

4 cubos con tapa
1 travesaño de 80 cm
2 presentadores de 4 bols
8 bols de melamina
1 estante estrecho de 80 cm.

4 cubes with lid
1 crossbar 80 cm length
2 displays for 4 bowls
8 melamine bowls
1 narrow shelf 80 cm.

4 cubes avec couvercle
1 longeron 80 cm
2 présentoirs pour 4 bols
8 bols mélamine
1 tablette étroite 80 cm.

4 Behälter mit Deckel
1 Traverse von 80 cm
1 Halter für 4 Schalen
8 Schalen aus Melamin
1 schmales Regal von 80 cm.

P905.400 **Conjunto básico estante 2 niveles / Basic two levels presentation kit /**
 Kit basique présentation 2 niveaux / Basisregalset 2 Ebenen



REF 

P905.400 1

Incluye / Includes / Includ / Inklusive:

4 cubos con tapa
1 estante ancho de 100 cm
1 estante estrecho de 100 cm.

4 cubes with lid
1 wide shelf 100 cm
1 narrow shelf 100 cm.

4 cubes avec couvercle
1 tablette large 100 cm
1 tablette étroite 100 cm.

4 Behälter mit Deckel
1 breites Regal von 100 cm
1 schmales Regal von 100 cm.

P905.410 Conjunto estante dos niveles forma "L" / "L" shape two levels presentation kit / Kit présentation "L" 2 niveaux / Regalset 2 Ebenen "L" Form

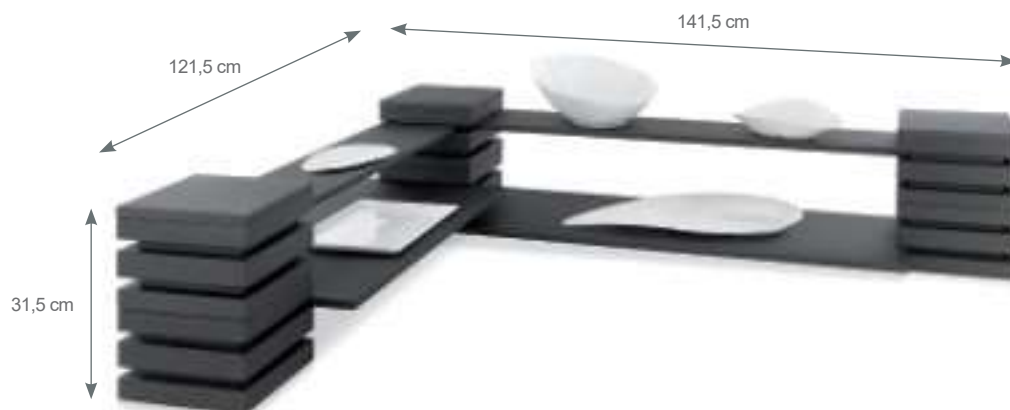
REF 

P905.410 1

Incluye / Includes / Inclus / Inklusive:

6 cubos con tapa
1 estante ancho de 100 cm
1 estante estrecho de 100 cm
1 estante ancho de 80 cm
1 estante estrecho de 80 cm.

6 cubes with lid
1 wide shelf 100 cm
1 narrow shelf 100 cm
1 wide shelf 80 cm
1 narrow shelf 80 cm.

6 cubes avec couvercle
1 tablette large 100 cm
1 tablette étroite 100 cm
1 tablette large 80 cm
1 tablette étroite 80 cm.

6 Behälter mit Deckel
1 breites Regal von 100 cm
1 schmales Regal von 100 cm
1 breites Regal von 80 cm
1 schmales Regal von 80 cm.

P905.300 Conjunto 2 bandejas presentación 40x40 cm / Two trays 40x40 cm presentation kit / Kit présentation pour deux plateaux 40x40 cm / Set mit 2 Präsentationstabletts 40x40 cm

REF 

P905.300 1

Incluye / Includes / Inclus / Inklusive:

4 cubos con tapa
1 travesaño de 100 cm
2 bandejas presentación de 40 x 40 cm.

4 cubes with lid
1 crossbar 100 cm length
2 serving trays 40 x 40 cm.

4 cubes avec couvercle
1 longeron 100 cm
2 plateaux présentation 40 x 40 cm.

4 Behälter mit Deckel
1 Traverse von 100 cm
2 tablett 40 x 40 cm.

P905.310 Conjunto 2 niveles bandejas 40x40 cm / Two levels presentation kit for 40x40 cm trays / Kit présentation 2 niveaux pour plateaux 40x40 cm / Set 2 Ebenen mit 2 Präsentationstabletts 40x 40 cm

REF 

P905.310 1

Incluye / Includes / Inclus / Inklusive:

6 cubos con tapa
1 travesaño de 100 cm
2 bandejas presentación de 40 x 40 cm
1 estante estrecho de 100 cm.

6 cubes with lid
1 crossbar 100 cm length
2 serving trays 40 x 40 cm
1 narrow shelf 100 cm.

6 cubes avec couvercle
1 longeron 100 cm
2 plateaux présentation 40 x 40 cm
1 tablette étroite 100 cm.

4 Behälter mit Deckel
1 Traverse von 100 cm
2 Präsentationstabletts 40 x 40 cm
1 schmales Regal 100 cm.

P905.320 Conjunto 2 bandejas 60x40 cm / Two trays 60x40 cm presentation kit /
Kit présentation pour deux plateaux 60x40 cm / Set mit 2 Präsentationstabletts 60x40 cm



REF	
P905.320	1

Incluye / Includes / Inclus / Inklusive:

2 cubos con tapa
1 travesaño de 100 cm
2 bandejas presentación de 60 x 40 cm.

2 cubes with lid
1 crossbar 100 cm length
2 serving trays 60 x 40 cm.

2 cubes avec couvercle
1 longeron 100 cm
2 plateaux présentation 60 x 40 cm.

2 Behälter mit Deckel
1 Traverse von 100 cm
2 Präsentationstabletts 60 x 40 cm.

P905.340 Conjunto 2 niveles para bandejas 60x40 cm / Two levels for trays 60x40 cm presentation kit /
Kit présentation 2 niveaux pour plateaux 60x40 cm / Set 2 Ebenen mit 2 Präsentationstabletts 60x40 cm



REF	
P905.340	1

Incluye / Includes / Inclus / Inklusive:

6 cubos con tapa
1 travesaño de 100 cm
2 bandejas presentación de 60 x 40 cm
1 estante estrecho de 100 cm.

6 cubes with lid
1 crossbar 100 cm length
2 serving trays 60 x 40 cm
1 narrow shelf 100 cm.

6 cubes avec couvercle
1 longeron 100 cm
2 plateaux présentation 60 x 40 cm
1 tablette étroite 100 cm.

6 Behälter mit Deckel
1 Traverse von 100 cm
2 Präsentationstabletts 60 x 40 cm
1 schmales Regal 100 cm.

P905.200 Conjunto buffet desayuno / Breakfast buffet displayer kit /
Kit présentation petit déjeuner / Frühstücksbuffetset



REF	
P905.200	1

Incluye / Includes / Inclus / Inklusive:

2 cubos con tapa
1 travesaño de 80 cm
1 bandeja presentación de 60 x 40 cm
1 kit completo dispensador de zumos de 6 lts.

2 cubes with lid
1 crossbar 80 cm length
1 serving tray 60 x 40 cm
1 complet kit juice dispenser 6 lts.

2 cubes avec couvercle
1 longeron 80 cm
1 plateau présentation 60 x 40 cm
1 kit complet distributeur à jus 6 lts.

2 Behälter mit Deckel
1 Traverse von 80 cm
2 Präsentationstabletts 60 x 40 cm
1 komplettes Saftspenderset 6 Liter.



P904.808 Dispensador de líquidos metálico 6 lts. / Metallic liquid dispenser 6 lts. / Distributeur de liquides métallique 6 L / Getränke-Metallspender6l



NEW!



REF	mm	H mm	L	
P904.808	230 x 390	490	6	1

Cubo metálico pintado en color negro/
Metallic cube painted in black colour/
Bac métallique noir /
Metallbehälter schwarz lackiert

DISEÑADO PARA USO INTENSIVO. EVITA PROBLEMAS DE CONDENSACIÓN /
DESIGNED FOR INTENSIVE USE. PREVENTS CONDENSATION PROBLEMS /
CONÇU POUR USAGE INTENSIF. ÉVITE LES PROBLÈMES DE CONDENSATION /
AUSGELEGT FÜR EINEN INTENSIVEN GEBRAUCH. VERMEIDET KONDENSATIONSPROBLEME

P904.800 Dispensador zumos 6 lts. / Juice dispenser 6 lts. / Distributeur à jus 6 lts / Saftspender 6 Liter

Superficie superior de Abedul finlandés /

Upper Surface Of Finnish Birch /

Surface supérieure en bouleau finlandais /

Oberfläche Finnischer Birke.



REF	mm	H mm	L	
P904.800	230 x 390	490	6	1

P904.790 Expositor GN 2/3, tres niveles / Three levels 2/3 GN stand / Présentoir 3 niveaux pour GN 2/3 / Ständer GN 2/3 drei Ebenen

Incluye / Includes / Inclus / Inklusive:

3 cubetas GN 2/3 20 mm /
3 GN containers 2/3 20 mm /
3 bags GN 2/3 20 mm /
3 GN 2/3 20 mm.



REF	mm	H mm	
P904.790	650 x 380	590	1

EXCLUSIVE



P904.350 Bandeja GN presentación pinchos / GN skewer serving tray /
 Plateau GN présentation piques / GN Servierplatte für Spiesschen



GN 1/1

REF	mm	H mm	Agujeros Holes Ø mm	Pinchos Piques	
P904.350	539 x 335	77	4	84	1

Incluye:
 bandeja madera
 bandeja melamina roble
 soporte interior pinchos /

Inclus :
 plateau bois
 plateau mélamine chêne
 support intérieur piques /

Includes:
 wooden tray
 oak melamine tray
 interior skewer stand /

Enthält:
 Holztablett
 Platte aus Eiche/Melamin
 Lochplatte für Spiesschen

P904.360 Soporte presentación pincho estante / Skewer serving rack stand /
 Support présentation piques plaque / Schmale Regalhalterung zum Angebot von Spiesschen

INOX - ST/STEEL
 EDELSTAHL



REF	mm	H mm	Agujeros Holes Ø mm	Pinchos Piques	
P904.360	448 x 182	42	4	40	1



Para estante / For shelf /
 Pour tablette / Für holsregal
 P904.650 / P904.651.

P. 438

Ver productos en / See products on / Voir produits en page / Siehe produkte in

P. 491

TAPAS ACERO INOXIDABLE PARA PLATOS /
STAINLESS STEEL PLATE COVERS /
INOX COUVERCLES À ASSIETTE /
EDELSTAHL-TELLERHAUBEN



ROOM SERVICE

**P904.780** Bandeja porta-cubiertos / *Cutlery-holdertray* / Plateau porte-couverts / *Beteckbehälter*

4 compartimentos / 4 compartments /
4 compartiments / 4 Fächer
303 x 115 mm

REF	mm	H mm	
P904.780	539 x 335	77	1

Apilables.
Stackables.
Empilables.
Stapelbar.



GN 1/1

P904.740 Bandeja presentación / *Serving tray* / Plateau présentation / *Präsentationstablett*

Apilables.
Stackables.
Empilables.
Stapelbar.

REF	mm	H mm	
P904.740	400 x 400	65	1

**P904.760** Bandeja servicio y presentación / *Serving tray* /
Plateau service et présentation / *Servier- und Präsentationstablett*

Apilables.
Stackables.
Empilables.
Stapelbar.

REF	mm	H mm	
P904.760	600 x 400	65	1



Perfecta para servicio de habitaciones.
Room service tray.
Plateau idéal pour service de chambre.
Perfekt für den Zimmerservice.

P904.711 Bandeja servicio y presentación GN 1/1 / *1/1 GN serving tray* /
Plateau service et présentation GN 1/1 / *Servier- und Präsentationstablett GN 1/1*

Apilables.
Stackables.
Empilables.
Stapelbar.

REF	mm	H mm	
P904.711	539 x 335 (1/1)	77	1



GN 1/1

No incluye cubeta gastronorm 1/1.
1/1 Gastronorm container not included.
Bacgastronorme 1/1 non inclus.
Nicht inklusive Gastronormbehälter 1/1.

P904.850

Mesita buffet GN 1/1 + taco madera /
1/1 GN wooden table + cutting board /
Table GN 1/1 en bois + planche à découper /
Buffettischchen GN 1/1 + Holzschneidebrett



REF	mm	H mm	
P904.850	530 x 325	120	1

P904.810

Mesita buffet baja + taco madera /
Low wooden table + cutting board /
Table basse en bois + planche à découper /
Flaches Buffettischchen + Holzschneidebrett



REF	mm	H mm	
P904.810	325 x 220	120	1
P904.820	325 x 220	165	1

P904.720

Servilletero y dispensador bolsas te y azúcar /
Napkin and tea & sugar bags dispenser /
Distributeur serviettes et des saquettes thé & sucre /
Serviettenhalter und Tee- und Zuckerbeutelhalter



P904.720



P904.725

REF	mm	H mm	
P904.720	220 x 220	55	1
P904.725	220 x 220	55	1

P904.155

Enfriador botellas buffet / Buffet wine cooler /
Rafraîchisseur bouteilles / Buffetflaschenkühler

Incluye: marco madera + cubeta GN 1/1 150 mm.
Includes: wooden frame + 1/1 GN pan 150 mm.
Inclus: cadre en bois + bac GN 1/1 150 mm.
Inklusive: Holzrahmen + GN 1/1 Behälter 150 mm.



REF	mm	H mm	
P904.155	570 x 370	145	1

P20.072

Portamenús metacrilato / Methacrylate holder /
Porte-menus méthacrylate / MethacrylatMenühalter



REF	cm	
P20.072	6 x 6	1



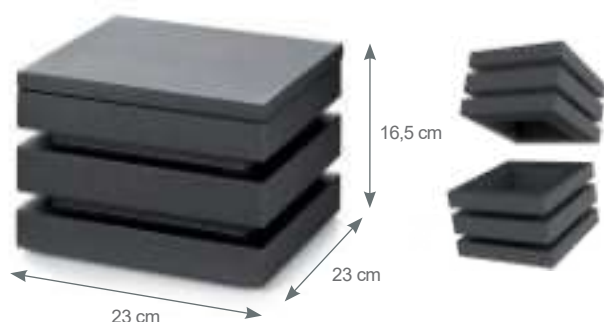

P904.600 Cubo con tapa madera / Wooden cube with lid /
Cube en bois avec couvercle / Behälter mit Holzdeckel

REF	
P904.600	1

P904.660 Tapa madera / Wooden lid / Couvercle en bois / Holzdeckel

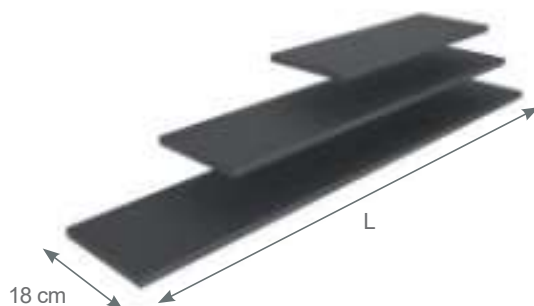
REF	
P904.660	1

P904.650 Estante madera estrecho / Wooden narrow shelf / Tablette en bois étroite / Schmales Holzregal

REF	L cm	
P904.650	50	1
P904.680	80	1
P904.610	100	1

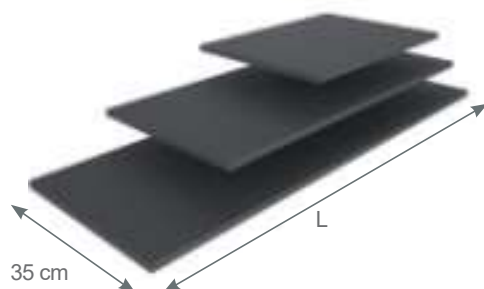
P904.652 Estante madera ancho / Wooden wide shelf / Tablette en bois large / Breites Holzregalbrett

REF	L cm	
P904.652	50	1
P904.682	80	1
P904.612	100	1

P904.950 Travesaño soporte bandejas / Crossbar buffet trays /
Longerons pour plateaux buffet / Tablethaltertraverse



REF	mm	H mm	
P904.950	500 x 124	20	1
P904.980	800 x 124	20	1
P904.990	1000 x 124	20	1



P904.937 Presentador 4 bols melamina cuadrados / Displayer for 4 melamine bowls /
Présentoir 4 bols mélamine / Halter für 4 quadratische Melaminschalen



REF	mm	H mm	
P904.937	375 x 500	15	1

Para bols cuadrados 180 x 180 /
For square bowls 180 x 180 /
Pour bols carrés 180 x 180 /
Für quadratische Schalen 180 x 180

REF. P22.202

P904.975 Presentador 6 bols melamina cuadrados / Displayer for 6 melamine bowls /
Présentoir 6 bols mélamine / Halter für 6 quadratische Melaminschalen



REF	mm	H mm	
P904.975	750 x 500	15	1

Para bols cuadrados 180 x 180 /
For square bowls 180 x 180 /
Pour bols carrés 180 x 180 /
Für quadratische Schalen 180 x 180

REF. P22.202

Ver productos en / See products on / Voir produits en page / Siehe produkte in

P.
370

BOL CUADRADO HONDO /
DEEP SQUARED BOWL /
BOL CARRÉ /
TIEFE QUADRATISCHE SCHÜSSEL



P904.165 Buffet perforado / Perforated buffet display / Buffet perforé / Gelochte Buffetvitrine

REF	mm	H mm	
P904.165	570 x 370	310	1

Incluye / Includes / Inclus / Inklusive:

Marco madera
bandeja perforada gn 1/1 65 mm
cubeta GN 1/1 20 mm
cúpula roll-top.

Wooden frame
perforated 1/1 GN pan 65 mm
gastronorm pan 1/1 20 mm
roll-top lid.

Cadre en bois
bac gn 1/1 65 mm perforé
bac GN 1/1 20 mm
couvercle roll-top.

Holzrahmen
gelochtes Tablett GN 1/1 Behälter 65 mm
GN 1/1 Behälter 20 mm
Rolldeckel.

P904.120 Buffet estandar / Standard buffet display / Buffet standard / Standardbuffet

REF	mm	H mm	
P904.120	570 x 370	310	1

Incluye / Includes / Inclus / Inklusive:

Marco madera
2 u. cubeta GN 1/1 20 mm
cúpula roll-top.

Wooden frame
2u. 1/1 GN 1/1 20 mm
roll-top lid.

Cadre en bois
2 u. bacs GN 1/1 20 mm
couvercle roll-top.

Holzrahmen
2 GN 1/1 Behälter 20 mm
Rolldeckel.

P904.113 Buffet triple / Triple buffet display / Buffet triple / Dreifach Buffetvitrine

REF	mm	H mm	
P904.113	570 x 370	310	1

Incluye / Includes / Inclus / Inklusive:

Marco madera
3 cubetas GN 1/3 65 mm
cubeta GN 1/1 20 mm
cúpula roll-top.

Wooden frame
3 units 1/3 GN pans 65 mm
GN pan 1/1 20 mm
roll-top lid.

Cadre en bois
3 bacs GN 1/3 65 mm
bac GN 1/1 20 mm
couvercle roll-top.

Holzrahmen
3 GN 1/3 65 mm Behälter
1 GN 1/1 Behälter 20 mm
Rolldeckel.

P904.140 Buffet quesos / Cheese buffet display / Buffet fromage / Buffetvitrine für Käse



REF	mm	H mm	
P904.140	570 x 370	310	1

Incluye / Includes / Inclus / Inklusive:
Marco madera
bandeja corte madera
cubeta GN 1/1 20 mm
cupula roll-top.

Wooden frame
wooden cutting board
gastronorm pan 1/1 20 mm
roll-top lid.

Cadre en bois
planque à découper en bois
bac GN 1/1 20 mm
couvercle roll-top.

Holzrahmen
Holzschnidebrett
1 GN 1/1 Behälter 20 mm
Rolldeckel.

P904.145 Buffet pan / Bread buffet display / Buffet pain / Buffet Brotplatte



REF	mm	H mm	
P904.145	570 x 370	145	1

Incluye / Includes / Inclus / Inklusive:
Marco madera
cortador pan madera
cubeta GN 1/1 20 mm.

Wooden frame
bread cutting board
1/1 GN container 20 mm.

Cadre en bois
plaque à découper pain en bois
bac GN 1/1 20 mm.

Holzrahmen
Holzbrottschneidebrett
1 GN 1/1 Behälter 20 mm.

P904.160 Buffet pizarra melamina / Melaminese slate buffet displayer /
Mélamine buffet ardoise / Buffet Melaminschiefertafel



REF	mm	H mm	
P904.160	570 x 370	145	1

Incluye / Includes / Inclus / Inklusive:
Marco madera
tabla pizarra melamina
cubeta GN 1/1 20 mm.

Wooden frame
melamine slate board
1/1 GN container 20 mm.

Cadre en bois
plaque ardoise en mélamine
bac GN 1/1 20 mm.

Holzrahmen
Melaminschiefertafel
1 GN 1/1 Behälter 20 mm.

Ver productos en / See products on / Voir produits en page / Siehe produkte in

P.
442

PLACA ENFRIADORA /
COOLING PLATE /
PLAQUE RÉFRIGÉRANTE /
KÄLTEPLATTE



P904.200 Marco madera / Wooden frame / Cadre en bois / Holzrahmen



REF	mm	H mm	
P904.200	570 x 370	145	1

P904.200

P904.400 Tapete isotérmico / Isothermal mat / Tapis isotherme / Isothermische Matte



P904.400

REF	mm	H mm	
P904.400	470 x 260	20	1

FRÍO / COLD / FROID / KALT

CALIENTE / HOT / CHAUD / WARM



P904.500 Placa enfriadora / Cooling plate /
Plaque réfrigérante / Kühlakku



● - 12 °C

Adaptable a cubeta GN 1/1.
Adjustable to 1/1 GN pan.
Adaptable à bac GN 1/1.
Geeignet Für GN 1/1 Behälter.

REF	mm	H mm	
P904.500	475 x 277	30	1

P904.142 Cortador pan madera /
Wooden bread cutting board /
Plaque à découper pain en bois /
Brotschneidebrett aus Holz

GN 1/1



REF	mm	H mm	
P904.142	530 x 325	20	1

Ver productos en / See products on / Voir produits en page / Siehe produkte in

P.
395

TAPA ROLL-TOP /
ROLL-TOP LID /
COUVERCLE ROLL-TOP /
ROLLDECKEL



Cortador pan madera /
Wooden bread cutting board /
 Plaque à découper pain en bois /
Brottschneidebrett aus Holz

P904.146



REF	mm	H mm	
P904.146	520 x 315	20	1

Taco madera para mesita buffet /
Cutting board for wooden table /
 Plaque à découper pour table en bois /
Holzschneidebrett für Buffettisch

P904.804

(1) Para / For / Pour / Für ref. P904.810 / P904.820 / P904.890
 (2) Para / For / Pour / Für ref. P904.850



P904.804



P904.809

REF	mm	H mm	
P904.804 ¹	292 x 187	22	1
P904.809 ²	497 x 292	22	1

Soporte bolsas te y azúcar /
Tea & sugar bag holder /
 Support pour saquettes de thé & sucre /
Tee- & Zuckerbeutelhalter

P904.721



Para / For / Pour / Für ref. P904.720

REF	mm	H mm	
P904.721	198 x 198	49	1

Cubo base dispensador zumos /
Juice dispenser cube holder /
 Cube base distributeur à jus /
Basisständer für Saftpender

P904.801



Superficie superior de Abedúl finlandés /
Upper surface of finnish birch /
 Surface supérieure en bouleau finlandais /
Oberfläche Finnischer Birke.

REF	mm	H mm	
P904.801	230 x 230	215	1

P904.807

Contenedor acrílico 6 Lts dispensador zumos con tapa /
6 Lts acrylic container with lid for juice dispenser /
 Conteneur acrylic 6 Lts avec couvercle pour distributeur à jus /
6 Liter Acrylbehälter mit Deckel für Saftpender



REF	Ø mm	H mm	Lts	
P904.807	220	280	6	1

Soporte y rejilla dispensador de zumos /
Base and grid for water drain /
 Base et grille pour distributeur à jus /
Basis und Gitter für Saftpender

P904.806



Superficie superior de Abedúl finlandés /
Upper surface of finnish birch /
 Surface supérieure en bouleau finlandais /
Oberfläche Finnischer Birke.

REF	mm	H mm	
P904.806	230 x 190	20	1

CUBIC®
EXCLUSIVE



CARRO BUFFET CON POSIBILIDAD DE CONVERTIR EL CARRO EXPOSITOR EN MESA DE PRESENTACIÓN /
BUFFET TROLLEY WITH POSSIBLE TRANSFORMATION FROM AN EXPOSITOR TROLLEY TO A PRESENTATION TABLE /
CHARIOT BUFFET AVEC POSSIBILITÉ DE CONVERTIR LE CHARIOT D'EXPOSITION EN UNE TABLE DE PRÉSENTATION /
BUFFETSERVIERWAGEN MIT DER MÖGLICHKEIT DIESEN IN EINEN PRÄSENTATIONSTISCH UMZUWANDELN



***Dos tapas incluidas en precio /**
***Two cover are included on the price /**
***Deux tablettes comprises dans le prix /**
***Zwei Deckel im Preis inklusive**
REF. P90.492

Tapa individual encaje GN 1/1 no incluida en precio /
Cover for 1/1 GN insert not included on the price /
Tablette de bac GN 1/1 non comprise dans le prix /
Individueller Deckel passend zu GN 1/1 nicht im Preis inklusive
REF. P90493

P90490 Carro buffet negro 4 GN 1/1 / Black buffet trolley for 4 1/1 GN inserts /
 Chariot buffet noir pour 4 bacs GN 1/1 / Schwarzer Buffetservierwagen 4 GN 1/1

REF	TIPO / TYPE	
P90.490*	4 X GN 1/1	1
P90.492	Tapa / Cover / Tablette / Deckel	1
P90.493	Tapa / Cover / Tablette / Deckel 1/1	1

Elegante combinación de madera y aluminio /
Outstanding combination of wood and aluminium /
 Combinaison élégante en bois et en aluminium /
 Elegante Kombination aus Holz und Aluminium



Madera con tratamiento hidrófugo especial, de fácil limpieza /
Wood with special waterproof treatment, easy to clean /
 Bois avec un traitement hydrofuge spécial, facile à nettoyer /
 Holz mit spezieller wasserabweisender behandlung, einfach zu reinigen



Barra refuerzo nivel inferior /
Reinforcement bar /
 Barre de renforcement /
 Bewehrungsstab



Ruedas giratorias e insonoras de Ø 125 mm, con freno /
Soundproof and revolving castors Ø 125 mm, with brakes /
 Roulettes insonores et pivotantes de Ø 125 mm, avec freins /
 Bewegliche und geräuschlose räder Ø 125 mm, mit bremsen



Se suministran desmontados entre 3 a 5 minutos de montaje /
Delivered flatpacked between 3 to 5 minutes assembly /
 Livrés démontés entre 3 et 5 minutes de montage /
 Lieferung unmontiert räder montage zwischen 3 und 5 minuten



Adaptado a medidas gastronorm /
Suitable for gastronorm sizes /
 Adapté aux mesures gastronorme /
Geeignet für gastronormgrößen

TREND

**Carro madera-aluminio 2 estanterías / Wooden-aluminium trolley 2 shelves /
Chariot en bois-aluminium 2 plateaux / Servierwagen Holz-Aluminium mit 2 Regalen**



Tratamiento hidrófugo / Waterproof treatment /
Traitement hydrofuge / Wasserabweisender Behandlung.

REF	Colour	
P80.210	Blanco / White / Blanc / Weiss	1
P80.220	Negro / Black / Noir / Schwarz	1



P80219 **Gueridón o carro auxiliar madera /
Wooden gueridon trolley /
Chariot guéridon en bois /
Abräum- oder Hilfswagen aus Holz**



Tratamiento hidrófugo / Waterproof treatment /
Traitement hydrofuge / Wasserabweisender Behandlung.

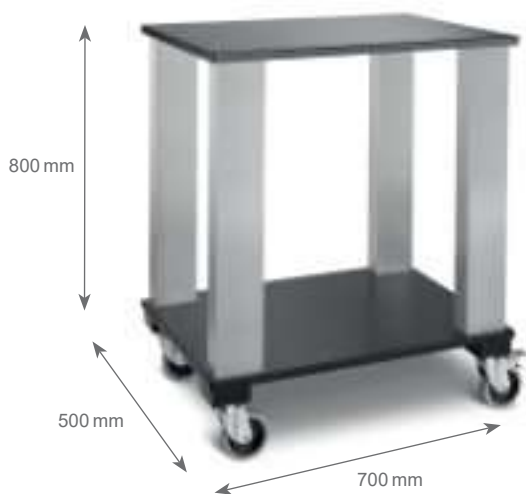

P80216 **Carro gueridón melamina roble /
Oak melamine gueridon trolley /
Chariot guéridon mélamine roure /
Servierwagen aus eiche melamine**

EXCLUSIVE



REF	Colour	
P80.219	Negro / Black / Noir / Schwarz	1

REF	Colour	
P80.216		1

P90813 Carro porta-cubiertos / Cutlery dispenser trolley /
 Chariot porte couverts / Transportwagen für besteck

EXCLUSIVE

REF			
P90.8132			1
P90.813			1



REF.P90.8132





REF.P90.813



No incluye porta-cubiertos, cubetas GN, platos ni bandejas /
Trays, dishes, GN containers and cutlery dispenser not included /
Ramasse-couverts, bacs GN, assiettes, et plateaux pas compris /
Besteckbehälter, GN behälter, platten und tablett nicht inklusive

P90814 Porta-cubiertos / Cutlery bin /
 Ramasse-couverts / Besteckbehälter

EXCLUSIVE

REF	mm		
P90.8142	710 x 335 x 155		1
P90.814	710 x 335 x 155		1

4 x 1/3 GN
 H max. 65 mm



REF.P90.8142



REF.P90.814



No incluye cubetas GN /
GN containers not included /
Bacs GN non inclus /
GN behälter nicht inklusive

BUFFET ACCESSORIES /
 BUFFET ACCESSOIRES /
 BUFFET ACCESSOIRES

**BUF
FET**

**BEST
SELLER**



P596110 Cesta rejilla GN negra / Black GN wire basket / Pannier metalique GN noir / Schwarzer GN Grillkorb

1/1



REF	Mod	L cm	H cm	
P596.110	1/1	52 x 31,5	12	6
P596.111	1/1	52 x 31,5	16	6

P596120 Cesta rejilla GN negra / Black GN wire basket / Pannier metalique GN noir / Schwarzer GN Grillkorb

1/2



REF	Mod	L cm	H cm	
P596.120	1/2	31,5 x 25,5	12	6
P596.121	1/2	31,5 x 25,5	16	6

P596130 Cesta rejilla GN negra / Black GN wire basket / Pannier metalique GN noir / Schwarzer GN Grillkorb

1/3



REF	Mod	L cm	H cm	
P596.130	1/3	31,5 x 17	12	6
P596.131	1/3	31,5 x 17	16	6

COMPATIBLE CON / SUITABLE FOR / ADAPTABLE POUR / GEEIGNET FÜR



P.
389



P.
388



P.
387



P.
443

**BUF
FET**



NATURAL
FIBERS

COMPATIBLE CON / SUITABLE FOR / ADAPTABLE POUR / GEEIGNET FÜR



Dos posiciones: derecho y revés.
Two positions: right and reverse.
Deux positions: droit et envers
Zwei Positionen: rechts und rückwärts.



P.
387



P.
389



P.
393



P.
405

P59511 Caja GN bambú buffet / GN buffet bamboo box / Présentoir GN buffet bambou / Buffet GN-Bambusbox

1/1



REF	Mod	H cm	
P595.110	1/1	10	1
P595.111	1/1	20	1

P59512 Caja GN bambú buffet / GN buffet bamboo box / Présentoir GN buffet bambou / Buffet GN-Bambusbox

1/2



REF	Mod	H cm	
P595.120	1/2	10	1
P595.121	1/2	20	1

P59513 Caja GN bambú buffet / GN buffet bamboo box / Présentoir GN buffet bambou / Buffet GN-Bambusbox

1/3



REF	Mod	H cm	
P595.130	1/3	10	1
P595.131	1/3	20	1

P59510 Bandeja - Tapa para caja GN bambú buffet / Tray - Lid for GN buffet bamboo box /
Plateau - Couverture pour présentoir GN buffet bambou / Abdeckung - Tablett für Buffet GN-Bambusbox



REF	Mod	H cm	
P595.100	1/1	2	1
P595.200	1/2	2	1
P595.300	1/3	2	1

SOPORTES PRESENTACIÓN / DISPLAY STANDS / SUPPORT PRÉSENTATION / HALTERUNG PRÄSENTATION



P59711 Expositor buffet / Buffet displayer / Présentoir buffet / Buffetständer



REF	cm	H cm	
P597.110	12,5 x 10,5	3,0	1
P597.120	12,5 x 10,5	6,0	1
P597.130	12,5 x 10,5	9,0	1

P597170 Expositor buffet extensible / Retractable display stand / Présentoir buffet rétractable / Rechteckiger Buffetständer

GN
1/1
1/2
1/3



REF	Max cm	Min cm	H cm Min / Max	
P597.170	53 x 32,5	32,5 x 17,6	6,5 / 10	1



Adaptable a cubetas GN.
Adjustable to GN container.
Adapté à bacs GN.
Passend für GN Behälter



Max. GN 1/1



GN 1/2



Min. GN 1/3

19196 Placa adaptadora angular / Angled Adaptor Plate / Plaque intermédiaire inclinée / Gewinkelte Adapterplatte



REF	cm	Tipo / Type	
19196	53 x 32,5 x 7,0	1 GN 1/1 (6°)	2

Eleva las cubetas para mejorar la presentación de los alimentos /

Elevates pans to enhance food presentation /

Élévages des bacs pour améliorer la présentation des aliments /

Erhöhte Pfannen zur Verbesserung der Lebensmittelpräsentation

P59714 Expositor buffet / Buffet displayer / Présentoir buffet / Buffetständer



REF	Ø A cm	Ø B cm	H cm	
P597.140	25	21	10	1
P597.150	25	21	20	1
P597.160	25	21	30	1

46009 Juego 3 expositores ángulos redondos / Set of 3 Square Bent Risers / Jeude 3 socles carrés aux angles arrondis / Set mit 3 quadratischen, gebogenen Ständern

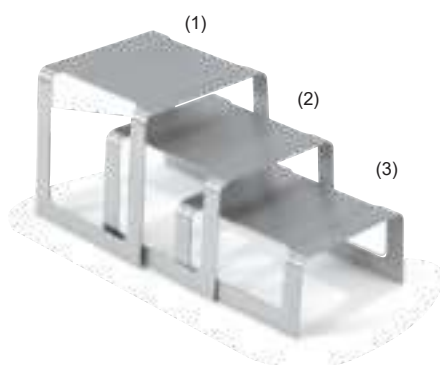

REF	mm	H mm	
46009	(1) 203 x 203	203	1
	(2) 203 x 191	152	
	(3) 203 x 178	102	

Acero inoxidable pulido /
Brushed Stainless Steel /
Inox brossé /
Gebürsteter Edel

4600960 Juego 3 expositores ángulos redondos / Set of 3 Square Bent Risers / Jeude 3 socles carrés aux angles arrondis / Set mit 3 quadratischen, gebogenen Ständern

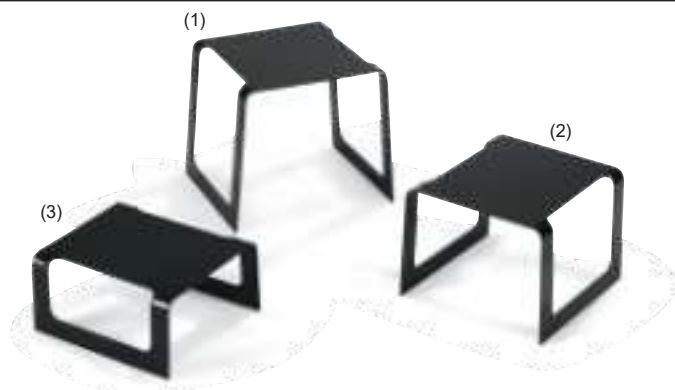

REF	mm	H mm	
4600960	(1) 203 x 203	203	1
	(2) 203 x 191	152	
	(3) 203 x 178	102	

Acero inoxidable pulido /
Brushed Stainless Steel /
Inox brossé /
Gebürsteter Edel

Negro / Black / Noir / Schwarz

Ver productos en / See products on / Voir produits en page / Siehe produkte in

P.
367

P.
376

P.
379

BOL REDONDO /
ROUND BOWL /
BOL ROND /
RUNDE SCHÜSSEL



SOPORTE PRESENTACIÓN /
DISPLAY PLATE /
PRÉSENTOIR /
PRÄSENTATIONSPLATTE



Intrigue™

CHAFERS DE INDUCCIÓN /
INDUCTION CHAFERS /
CHAFERSPOUR PLAQUE INDUCTION /
INDUKTIONS-RECHAUDS

**Un elegante y versátil
chafer con un diseño
de perfil bajo para una
mejor presentación**

**Modelo con parte superior
de vidrio que permite ver
la comida sin abrir el chafer
-manteniendo la calidad del
alimento.**

**Tapa removible con bisagra de
cierre lento. Tres ángulos de
apertura, cerrada, 45° ó 90°.**

**Soporte reforzado con piés
antideslizantes que permite
una mayor estabilidad.**

**La tapa y cubeta con sistema
anti-goteo mantienen la
condensación fuera del
alimento.**

**Se presenta con cubetas de
acero inoxidable brillante o de
porcelana.**

*An elegant yet versatile
chafer with a low profile
design for the best food
presentation*

*Glass top version allows viewing
of food without opening chafer –
maintaining food quality.*

*Removable cover with baffle,
"stay put" hinge design holds
cover in closed, 45° or 90°
position.*

*Reinforced bracket with rubber
table feet for longer life and to
keep chafer in place.*

*Dripless cover and pans keep
condensation off of food and
tabletop.*

*Available with mirror-finished
stainless steel or porcelain food
pans.*

**Un chafer élégant à la fois
polyvalent et discret pour
la meilleure présentation
des plats**

**Le modèle muni d'un couvercle
en verre permet de voir le
contenu sans ouvrir le chafer –
tout en préservant la qualité des
aliments.**

**Couvercle amovible équipé d'un
déflecteur et d'une charnière
bloquante qui permet de
maintenir le couvercle fermé, à
45° ou à 90°.**

**Support renforcé avec des pieds
de table en caoutchouc afin
d'offrir une durée de vie plus
longue et un meilleur maintien
des chafers.**

**Le couvercle antigouttes
et les bacs empêchent la
condensation des aliments et de
la table.**

**Disponibles avec bac à aliments
en inox ultra-brillant ou en
porcelaine.**

**Eleganter und zugleich
vielseitiger Rechaud in
schlichtem Design für die
niveauevolle Präsentation
von Speisen.**

**Die Version mit Glashaube
ermöglicht den Blick auf die
Speisen ohne den Rechaud zu
öffnen und bewahrt so ihre
Qualität.**

**Die zurück-klappbare Haube mit
gedämpftem Haltescharnier hält
die Haube geschlossen oder im
45° oder 90° Winkel geöffnet.**

**Die verstärkte Basis mit
Gummifüßen sorgt dafür, dass
der Rechaud lange einsetzbar
sowie standsicher bleibt.**

**Die tropffreie Haube und
tropffreien Wannen halten
Kondenswasser von Speisen und
Tischen fern.**

**Erhältlich mit Wannen aus
hochglanzpoliertem Edelstahl oder
Porzellan.**

46125 Chafing dish redondo con tapa cristal / Glass top S/S chafer with S/S trim /
 Chafer inox à couvercle en verre / Edelstahl-Chafer mit Glasdeckel, Details und Schüssel in Edelstahl



induction



REF		mm	L	
	Fuente acero inox.			
46125	S/S food pan Bacgastr. inox Edelstahlschüssel	394 x 80	5,8	1

46130 Fuente interior redonda / Food pan / Bac à aliments / Geflieste Schüssel



REF		mm	L	
46130	Porcelana Porcelain Porcelaine Porzellan	395 x 71	4,0	1
49130	Porcelana div. Divided porcelain Porcelaine Porzellan	395 x 71	3,5	1
46131	Acero inoxidable S/S Acier inoxydable Edelstahl	394 x 70	5,6	1

46134 Chafing dish cuadrado con tapa cristal / Glass top S/S chafer with S/S trim /
 Chafer inox à couvercle en verre / Edelstahl-Chafer mit Glasdeckel, Details und Schüssel in Edelstahl



induction



REF		mm	L	
	Fuente acero inox.			
46134	S/S food pan Bacgastr. inox Edelstahlschüssel	392 x 176 x 412	5,8	1
	Fuente porcelana			
46135	Porcelain food pan Bacgastr. porcel. Porzellanschüssel	392 x 176 x 412	5,8	1

46136 Fuente interior cuadrada / Food pan / Bac à aliments / Geflieste Schüssel



REF		mm	L	
46136	Porcelana Porcelain Porcelaine Porzellan	392 x 52 x 388	3,5	1
49136	Porcelana div. Divided porcelain Porcelaine Porzellan	392 x 52 x 388	3,5	1
46137	Acero inoxidable S/S Acier inoxydable Edelstahl	392 x 71 x 392	6,3	1

BUFFET ACCESSORIES /
BUFFET ACCESSOIRES /
BUFFET ACCESSOIRES

Standard

**CHAFINGS Y DISPENSADORES /
CHAFERS & DISPENSERS /
CHAFERS ET DISTRIBUTEURS /
CHAFERS & SPENDER**



P3875 Chafing dish rectangular con tapa roll top / Rectangular chafing dish roll top lid /
Chafing dish rectangulaire avec couvercle roll top / Rechteckiger Chafing dish mit Rolldeckel



REF	mm	L	
P387.500	740 x 450 x 410	9,0	1

Soporte, recipiente, cubeta, tapa y asas de chapa en acero inox. Con 2 quemadores.

Stand, water pan, insert, lid and St/Steel handles. With 2 burners.

Support, récipient, bac, couvercle et poignées en acier inox. Avec 2 brûleurs.

Ständer, Behälter, Wanne, Deckel und Griffe aus Edelstahlblech. Mit 2 Brennern.

P8975 Chafing dish redondo tapa roll top / Round chafing dish roll top lid /
Chafing dish rond avec couvercle roll top / Runder Chafing dish mit Rolldeckel



REF	ØA mm	ØB mm	AL mm	
P897.500	Ø350	Ø515	485	1

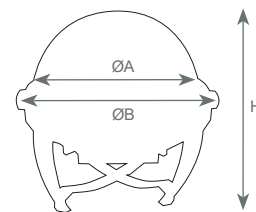

Apertura máxima: 180°.
Max. opening: 180°.
Ouverture maximale: 180°.
Max. Öffnung: 180°.

P387 Chafing dish con tapa tipo roll top / Chafing dish with roll top lid /
Chafing dish avec couvercle "roll top" / Chafing Dish mit Roll-top Deckel



REF	mm	L	
P387.065	650 x 380 x 390	9,5	1

Soporte, recipiente, cubeta, tapa y asas de chapa en acero inox. Con 2 quemadores.

Stand, water pan, insert, lid and St/Steel handles. With 2 burners.

Support, récipient, bac, couvercle et poignées en acier inox. Avec 2 brûleurs.

Ständer, Behälter, Wanne, Deckel und Griffe aus Edelstahlblech. Mit 2 Brennern.

P379 Chafing dish con tapa / Chafing dish with lid / Chafing dish avec couvercle / Chafing dish mit Deckel

REF	mm	L	
P379.065	650 x 350 x 340	9,5	1

Soporte, recipiente, cubeta, tapa y asas de chapa en acero inox. Con 2 quemadores.

Stand, water pan, insert, lid and St/Steel handles. With 2 burners.

Support, récipient, bac, couvercle et poignées en acier inox. Avec 2 brûleurs.

Ständer, Behälter, Wanne, Deckel und Griffe aus Edelstahlblech. Mit 2 Brennern.

P3795 Chafing dish económico con tapa / Economical chafing dish with lid /
Chafing dish économique avec couvercle / Preiswerter Chafing Dish mit Deckel

REF	mm	L	
P379.500	650 x 350 x 320	9,0	1

Soporte, recipiente, cubeta, tapa y asas de chapa en acero inox. Con 2 quemadores.

Stand, water pan, insert, lid and St/Steel handles. With 2 burners.

Support, récipient, bac, couvercle et poignées en acier inox. Avec 2 brûleurs.

Ständer, Behälter, Wanne, Deckel und Griffe aus Edelstahlblech. Mit 2 Brennern.

P962 Calentador de platos o bandejas / Hot tray warmer / Réchaud / Tablett - oder Tellerwarmhalter

REF	Quemadores / Burners / Brûleurs / Brenner	mm	
P962.002	2	370 x 175 x 70	1
P962.003	3	430 x 175 x 70	1

Inox con placa base de aluminio.
St/Steel with aluminium cover plate.
Inox avec plaque couvercle en aluminium.
Rostfreier Stahl mit Aluminium Basisplatte.

2 ó 3 quemadores.
2 or 3 burners.
2 ou 3 brûleurs.
2 oder 3 Brenner.

Elemento eléctrico para chafing dish /
Electric heating unit for chafing dish /
Corps de chauffe pour chafing dish /
Elektrisches Element für chafing dish

P950000

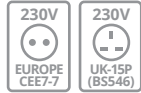

Para / For / Pour / Für:

P387500, P897500, P387065, P379065, P379500

REF	W	
P950.000	240	1

Elemento eléctrico universal para chafing dish /
Universal electric chafing heater /
Résistance électrique pour chafers /
Universelle Rechaud-Elektroheizung

46110



Dimensiones compatibles con el orificio para combustible estándar.
Sized to fit standard fuel opening.

Dimensions compatibles avec l'orifice pour combustible standard.
Abmessungen sind kompatibel mit den Öffnungen für Standardbenzin.

REF	Para / For	V	W	A	Ench. Plug	
46110	EU	230	120/230	1.0	EU	1
46115	UK	230	120/230	1.0	UK	1

P3871/P3872 **Fuel para chafing dish / Chafing dish fuel /**
Fuel pour chafing dish / Brennstoff für chafing dish



Gracias a su fórmula especial no hay ninguna restricción especial por almacenaje o transporte. No gotea ni se derrama. No se evapora si se deja abierto. Puede guardarse si no se consume todo. No inflamable. No tóxico. Fácil de abrir y cerrar. La lata no se calienta. Fácil de encender una vez apagada.

Thanks to its special formula no storage or transport restriction are involved. Resealable. Non spill - Non drip. Non flammable. Non combustible. Non toxic fuel. Easy open & close. Container does not become hot to touch. Does not evaporate if left uncapped.

Grâce à sa formule spéciale il n'y pas de restriction pour le stockage et le transport. Hermétique. Non inflammable. Non combustible. Non toxique. Facile à ouvrir et fermer. On peut le garder si on ne le consomme pas tout. Facile à allumer une fois éteint.

Dank seiner speziellen Formel gibt es keinerlei spezielle Beschränkung für den Transport oder Lagerung. Wiederverschliessbar. Keine Verdampfung beim Auflassen. Wiederverwendbar bei nicht vollständigem Verbrauch. Nicht leicht entzündbar. Nicht giftig. Einfach zu öffnen und verschliessen. Die Dose erhitzt sich nicht. Einfach anzuzünden einmal ausgegangen.

REF	mm	Duración / Length / Durée / Daaer	
P387.100	650 x 550	3 h	75
P387.200	830 x 600	6 h	60

Contenedor para combustible de chafing dish /
Burner holder for chafing dish /
Porte-brûleur pour chafing dish /
Brennstoffbehälter für chafing dish

P3722

Adaptable. REF:
P379, P387, P898, P8991



REF	
P372.200	1

Fuel para chafing dish /
Chafing dish fuel barrel /
Bidón fuel chafing dish /
Brennstoff für chafing dish

P685

ETANOL / ETHANOL

Sin hollín. Sin olor /
No soot. No smell /
Pas de suie. Inodore /
Kein Russ. Kein Gerusch.



REF	L	KG	
P685.004	5	5	1



P903 Placa enfriadora / Cooling plate / Plaque réfrigérante / Kälteplatte

INOX - ST/STEEL
EDELSTAHL
18/10

REF	Tipo/Type	mm	
P903.001	1/1	530 x 325	1
P903.002	1/2	325 x 265	1



Para una presentación fácil e higiénica de alimentos fríos en los buffets. En el congelador: Mínimo 4h por debajo de los -4 °C. Aguanta 5-6h con temperaturas por debajo de los 23 °C.

For an easy and hygienic presentation of cold food. Simple place in the freezer. Minimum 4 hour under -4°C. Tolerance under 23°C: 5-6h.

Pour une présentation hygienique et facile des aliments froids sur les buffets. Au congélateur. Minimum 4h à des températures inférieures à -4 °C. Résistance à des températures inférieures à 23 °C: 5-6h.

Für die einfache und hygienische Präsentation von kalten Lebensmittel auf den Buffets. Im Gefrierschrank: Mindestens 4h unter -4 °C. Hält 5-6h Temperaturen unter 23 °C stand.

78710 Baño maría / Bain maries / Bain-marie / Wasserbad



REF	Ø cm	H cm	L	
78710	10,5	14,5	1,20	6
78720	12,5	17,0	1,90	6
78725	15,5	10,0	1,90	6
78730	15,5	18,5	3,30	6
78740	16,5	19,5	4,00	6
78760	18,5	22,0	5,70	6

DISPENSADORES LÍQUIDOS Y CEREALES /
JUICE & CEREALS /
DISTRIBUTEUR À JUS ET CÉRÉALES /
SAFT- / FRÜHSTÜCKFLOCKENSPENDER



Dispensador de zumos - acero inox /
Juice dispenser St/Steel /
 Distributeur à jus - acier inox /
 Saftspender - Edelstahl

P8992



REF		L	
P899.200	Acero inox / St/Steel	8,0	1

Dispensador de leche - acero inox /
St/Steel milk dispenser /
 Distributeur à lait - acier inox /
 Milchspender Edelstahl

P8993



REF		L	
P899.300	Acero inox / St/Steel	8,0	1

Dispensador de cereales doble /
Double Cereal Dispenser /
 Distributeur à céréales double /
 Getreideflocken-Doppelbehälter

4635210



REF	mm	L (x2)	
4635210	310 x 220 x 600	3,8	1

Dispensador de cereales D-Lux /
D-Lux cereal dispenser /
 Distributeur à céréales D-Lux /
 D-Lux-Getreideflockenspender

T3660



REF	mm	L	
T3660	254 x 356 x 686	8,0	1

**BOLS SERVICIO DOBLE PARED/
DOUBLE WALL INSULATED SERVING BOWLS/
BOLS SERVICEDOBLE PARI ISOHERMES/
DOPPELWANDIGE SCHALEN**

Construcción aislante de pared doble que permite conservar la temperatura de los alimentos, ya sean fríos o calientes/

Double wall insulated serving bowls that allows keeping the food temperature, whether cold or hot/

Construction d'isolation à double paroi qui permet de maintenir la température de la nourriture, froide ou chaude/

Doppelwandige Isolierungsschalen, die die Temperatur des Lebensmittels halten, sei es kalt oder heiß



No transpiran. No es necesario precalentar o enfriar/

Will not TRANSPIRE. Requires no preheating or chilling/
Pasde condensation sur les parois. N'exige aucun préchauffage ou refroidissement/
Keine kondensatbildung. Erfordert kein Vorwärmen oder Abkühlen

Paredes aislantes que mantienen los alimentos a la temperatura de servicio/

Insulating walls that keep food at service temperature/
Construction isolant qui garde les aliments à la température de service/
Die Isolierungswände halten das Essen auf Betriebstemperatur.



**LAVAR A MANO/
HAND WASHING/
LAVERÀ LA MAIN/
VON HAND WASCHEN**

**Retención del frío:
Bols aislantes de doble pared
PROTOCOLO DE PRUEBA, 2004**

**Cold retention:
Double wall insulated bowls
TEST PROTOCOL, 2004**

**Rétention du froide:
Construction d'isolation
à double paroi
PROTOCOLE D'ESSAI, 2004**

**Kältespeicherung:
Doppelwandige isolierte
schalen
TESTPROTOKOLL, 2004**

**TEMPERATURA/
TEMPERATURE/
TEMPÉRATURE/
TEMPERATUR
(Celsius/Fahrenheit)**

— 46591 3.2 L
— 47652 3.5 L
— 46592 6.6 L

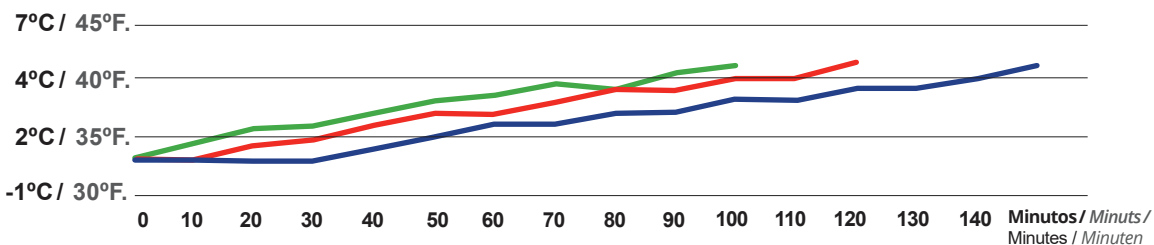

1. Se colocó ensalada de patatas en diversos bols, llenando ¾ de la capacidad del bol.
2. Temperatura inicial de la comida 0,6°C; temperatura ambiente 20,6°C.
3. Cada 10 minutos se registró la temperatura en el centro de la ensalada.
4. La prueba concluyó cuando la comida alcanzó una temperatura de 5°C.

1. Potato salad was placed in different bowls. Filling ¾ of the capacity of the bowl.
2. Initial temperature of the food 0,6°C; ambient temperature 20,6°C.
3. The temperature in the centre of the salad was recorded every 10 minutes.
4. The test concluded when the food reached a temperature of 5°C.

1. La salade de pommes de terre a été placée dans différents bols. Remplissage ¾ de la capacité du bol.
2. La température initiale de l'aliment 0,6°C; température ambiante 20,6°C.
3. La température au centre de la salade a été enregistrée toutes les 10 minutes.
4. Le test s'est terminé lorsque la nourriture a atteint une température de 5°C.

1. Kartoffelsalat wurde in verschiedene Schalen gegeben. Es wurden ¾ der Kapazität der Schüssel gefüllt.
2. Anfangstemperatur des Lebensmittels 0,6°C; Umgebungstemperatur 20,6°C.
3. Die Temperatur in der Mitte des Salats wurde alle 10 Minuten aufgezeichnet.
4. Der Test wurde abgeschlossen, als das Essen eine Temperatur von 5°C erreichte.

Bol colores redondo doble pared /

Round Colored Double Wall Bowls /

46587 Bols ronds de service à double paroi isothermes en couleurs /
Runde Servierschalen, doppelwandig isoliert und farbig

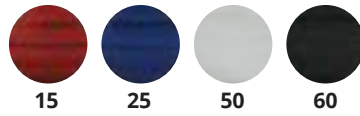

REF	Ø mm	H mm	L	
46587 + COLOR	114	76	0,7	6
46590 + COLOR	184	103	1,6	6
46591 + COLOR	241	129	3,2	6
46592 + COLOR	300	165	6,6	3



Bol colores cuadrado doble pared /

Square Colored Double Wall Bowls /

47619 Bols carrés de service à double paroi isothermes en couleurs /
Runde Servierschalen, doppelwandig isoliert und farbig

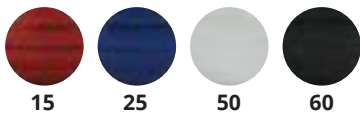

REF	mm	H mm	L	
47619 + COLOR	139 x 139	70	0,7	6
47632 + COLOR	184 x 184	87	1,7	12
47634 + COLOR	216 x 216	108	3,0	6
47635 + COLOR	258 x 258	130	4,9	4





Bol cónico doble pared /
Conical beehive bowls /
Bols double paroi évasée /
Konische doppelwandige Schale

46575



REF	Ø mm	H mm	L	
46575	160	69	0,59	1
46576	200	88	1,30	1
46577	240	108	2,40	1

Bol inclinado doble pared /
Angled beehive bowls /
Bols nid d'abeilles à paroi inclinée /
Angewinkelte Bienenstock-Schüsseln

46584



REF	Ø mm	H mm	L	
46584	188	139	0,95	6
46585	240	173	1,7	6
46586	300	209	3,5	2
46582	350	239	4,7	2

Bol estriado cuadrado doble pared /
Double-Wall Square Beehive Serving Bowls /
Bol lis carré double paroi /
Doppelwandige, quadratische, gerillte Schale

47619



REF	mm	H mm	L	
47619	139 x 139	70	0,7	6
47632	185 x 185	89	1,7	12
47634	218 x 218	108	3,0	6
47635	244 x 244	131	4,9	4
47637	299 x 299	150	7,8	3

Bol estridado redondo doble pared /
Beehive Style Double-Wall Serving Bowls /
Bol à bande rond double paroi /
Geriffelte, runde, doppelwandige Schüssel

46587



Acero inoxidable brillante /
Mirror finished /
Polissage brillant /
Mirror finished

REF	Ø mm	H mm	L	
46587	144	76	0,7	6
46590	184	103	1,6	6
46591	241	129	3,2	6
46592	300	165	6,6	3
46569	350	175	9,6	2

46665 **Bol redondo doble pared con aro brillante / Beehive Style Double-Wall Serving Bowls /**
Bol bande brillant rond double paroi / Runde, doppelwandige Schale mit glänzendem Ring



REF	Ø mm	H mm	L	
46665	144	76	0,7	6
46666	184	103	1,6	6
46667	241	129	3,2	6
46668	300	165	6,6	3

Cuerpo pulido satinado. Borde superior pulido brillante /
Body mat finished. Rim mirror finished /
Finition corps satinée / Finition bande brillante /
Matte Lackierung aussen / Glänzende Lackierung am Rand

INOX - ST/STEEL/ DELSTAHL 18/10

Borde con acabado satinado e interior brillante, creando una elegante contraste visual

Satin-finished rim and mirror-finished interior creates a visual contrast that accentuates the food product

Le rebord satiné et l'intérieur ultra-brillant crée un contraste visuel qui met en valeur les plats

Rand mit satiniertem Finish und Innenseite glänzend, wodurch sich ein optischer Kontrast ergibt, der die Speisen hervorhebt.

82093 Bandeja servicio rectangular acero inoxidable / Rectangular Stainless Steel serving trays / Plateau service rectangulaire / Rechteckiges Serviertablett



REF	mm	
82093	305 x 229	3
82094	457 x 254	3
82095	533 x 305	3

82060 Bandeja servicio oval acero inoxidable / Oval Stainless Steel serving trays / Plateau service oval / Ovaes Serviertablett



REF	mm	
82060	375 x 276	3
82061	448 x 330	3
82062	537 x 394	3

P317 Fuente oval borde vuelto / Oval serving dish with rolled edge / Plat ovale à bords ronds / Ovaes Serviertablett mit abgerundetem Rand



REF	cm	
P317.025	25 x 17,2	1
P317.030	30 x 20,2	1
P317.035	35 x 23,3	1
P317.040	40 x 26,7	1
P317.045	45 x 29,2	1
P317.050	50 x 31,2	1

Pulido satinado / Satin finished /
Polissage satiné / Satiniert poliert

P3174 Fuente oval borde vuelto económica / Economical oval serving dish with rolled edge / Plat ovale à bords ronds économique / Ovaes ökonomisches Serviertablett mit abgerundetem Rand



REF	cm	
P317.425	25 x 17,5	1
P317.430	30 x 21,0	1
P317.435	35 x 24,0	1
P317.440	40 x 26,5	1
P317.445	45 x 29,5	1
P317.450	50 x 34,0	1

Pulido brillante / Mirror finished /
Polissage brillant / Satiniert poliert

P907 Sopera inox con base / *St/Steel soup tureen with stand* /
 Soupière inox avec pied / *Edelstahlsuppenschüssel mit Fuss*



REF	Ø cm	L	
P907.024	24	2,50	1
P907.026	26	3,50	1

Pulido brillante / *Mirror finished* /
 Polissage brillant / *Satiniert poliert*

P927 Ensaladera acrílica redonda / *Acrylic round salad bowl* /
 Saladier rond acrylique / *Runde Acrylsalatschüssel*



REF	Ø mm	H mm	
P927.000	258 x 158	158	6

P928 Ensaladera acrílica cuadrada / *Acrylic Squared salad bowl* /
 Saladier carré acrylique / *Quadratische Acrylsalatschüssel*



P928.000



P928.001

REF	mm	
P928.000	285 x 285 x 124	12
P928.001	147 x 147 x 70	24

**UTENSILIOS DE SERVICIO /
SERVING TOOLS /
UTENSILES DE SERVICE BUFFET /
*SERVIERBESTECK***





P361

Cacillo monobloc /
One piece ladle /
 Louche monobloc /
 Schöpflöffel Monoblock



REF	Ø cm	L cm	L	
P361.000	9	30	0,10	1

P362

Espumadera monobloc /
One piece skimmer /
 Écumoire monobloc /
 Schaumlöffel Monoblock



REF	Ø cm	L cm	L	
P362.000	11	33,5	10,40	1

P363

Espátula monobloc /
One piece turner /
 Spatule monobloc /
 Pfannenwender Monoblock



REF	L cm	
P363.000	32	1

P364

Cuchara de servicio monobloc /
One piece serving spoon /
 Cuillère de service monobloc /
 Servierlöffel Monoblock



REF	L cm	
P364.000	31	1

P365

Tenedor monobloc /
One piece fork /
 Fourchette monobloc /
 Fleischgabel Monoblock



REF	L cm	
P365.000	32	1

P366

Cacillo salsas monobloc /
One piece sauce ladle /
 Cuillère à sauces monobloc /
 Sossenlöffel Monoblock



REF	Ø cm	L cm	L	
P366.000	7	28	0,10	1

P367

Cuchara ensalada monobloc /
One piece salad spoon /
 Cuillère à salade monobloc /
 Salatlöffel Monoblock



REF	L cm	
P367.000	30	1

P368

Cuchillo cocina /
Carving knife /
 Couteau à pâtisserie /
 Küchenmesser



REF	L cm	
P368.000	28,5	1

P369

Pala pasteles /
Cake server /
 Pelle à gâteau /
 Keksschaufel



REF	L cm	
P369.000	22	1

BUFFET Y ACCESORIOS /
 BUFFET & ACCESSORIES /
 BUFFET ET ACCESSOIRES



Pulido brillante.
Mirror polishing.
Polissage brillant.
Glänzend poliert.

Cacillo monobloc /

One piece ladle /

Louche monobloc /

P3611 *Schöpflöffel Monoblock*



REF	Ø cm	L cm	L	
P361.100	9,5	32	0,15	1

Espumadera monobloc /

One piece skimmer /

Écumoire monobloc /

P3621 *Schaumlöffel Monoblock*



REF	Ø cm	L cm	L	
P362.100	11	35	7,15	1

Espátula monobloc /

One piece turner /

Spatule monobloc /

P3631 *Pfannenwender Monoblock*



REF	L cm	
P363.100	37	1

Cuchara de servicio monobloc /

One piece serving spoon /

Cuillère de service monobloc /

P3641 *Servierlöffel Monoblock*



REF	L cm	
P364.100	34,5	1

Tenedor monobloc /

One piece fork /

Fourchette monobloc /

P3651 *Fleischgabel Monoblock*



REF	L cm	
P365.100	37	1

Cuchara para spaghetti /

Spaghetti server /

Cuillère à spaghetti /

P3671 *Spaghettilöffel*



REF	L cm	
P367.100	35	1

P3691 *Pala pasteles / Cake server / Pelle à gâteau / Keksschaufel*



REF	L cm	
P369.100	31	1



Pulido satinado mate.
Mat satiny finished.
 Poli satiné mat.
 Matt satiniert poliert.

P341 **Cacillo monobloc. Acero inox 18% cr. /**
One piece ladle. 18% cr. St/Steel /
Louche monobloc. inox 18% cr. /
Schöpflöffel Monoblock. Edelstahl 18 % Cr



REF	Ø cm	L cm	L	
P341.000	8,5	28	0,10	12

P342 **Espumadera monobloc. inox 18% cr. /**
One piece skimmer. 18% cr. St/Steel /
Écumoire monobloc. inox 18% cr. /
Schaumlöffel Monoblock. Edelstahl 18 % Cr



REF	Ø cm	L cm	
P342.000	11	33	12

P343 **Espátula monobloc. inox 18% cr. /**
One piece turner. 18% cr. St/Steel /
Spatule monobloc. inox 18% cr. /
Pfannenwender Monoblock. Edelstahl 18 % Cr



REF	L cm	
P343.000	33	12

P344 **Tenedor monobloc. inox 18% cr. /**
One piece fork. 18% cr. St/Steel /
Fourchette monobloc. inox 18% cr. /
Fleischgabel Monoblock. Edelstahl 18 % Cr



REF	L cm	
P344.000	30	12

P345 **Cuchara monobloc. inox 18% cr. / One piece spoon. 18% cr. St/Steel**
Cuillère monobloc. inox 18% cr. / Servieröffel Monoblock. Edelstahl 18 % Cr



REF	L cm	
P345.000	34	12

48144 **Cuchillo chuletero, mango plástico negro /**
Steak knife black plastic handle /
Couteau Steakmanche noir plastique /
Steakmesser, Kunststoffgriff, schwarz



Pack: 12 u.

REF	Hoja / Blade / Lame / Blatt L cm	TOTAL L cm	
48144	12,4	25,1	12

48148 **Cuchillo chuletero, mango plástico madera /**
Steak knife riveted wooden handle /
Couteau Steakmanche bois plastique /
Steakmesser, Kunststoff- / Holzgriff



Pack: 12 u.

REF	Hoja / Blade / Lame / Blatt L cm	TOTAL L cm	
48148	12,7	25,1	12



Inox + Nylon
St/Steel + Nylon
Rostfreier Stahl + Nylon
-40°C +210°C

P33614 **Pinza / Tong / Pince / Zange**



REF	L cm	
P33.614	34,5	12

P33601 **Cacillo / Ladle / Louche / Schöpflöffel**



REF	L cm	Lts	
P33.601	32	0,08	12

P33602 **Espumadera / Skimmer /**
Écumoire / Schaumlöffel



REF	L cm	Lts	
P33.602	35	11,5	12

P33603 **Cuchara de servicio / Serving spoon /**
Cuillère de service / Servierlöffel



REF	L cm	
P33.603	34,5	12

P33604 **Espátula / Turner / Spatule / Pfannenwender**



REF	L cm	
P33.604	35,5	12



Nylon + Inox
 Nylon + St/Steel
 Nylon + Rostfreier Stahl

-40°C +210°C



dishwasher

P33621 **Cacillo / Ladle / Louche / Schöpflöffel**



REF	L cm	Lts	
P33.621	35	0,08	1

P33622 **Cuchara de servicio / Serving spoon /**
Cuillère de service / Servierlöffel



REF	L cm	
P33.622	35	1

P33623 **Cuchara perforada / Slotted spoon /**
Cuillère à fente / Perforiert Löffel



REF	L cm	
P33.623	35	1

P33624 **Espátula / Turner /**
Patule / Pfannenwender



REF	L cm	
P33.624	35	1

P33625 **Cuchara para spaghetti / Spaghetti server /**
Cuillère à spaghetti / Spaghettilöffel



REF	L cm	
P33.625	35	1



P33801

Cuchara de servicio de madera /
Wooden serving spoon /
 Cuillère de service en bois /
 Holz-Servierlöffel



REF	L cm	
P33.801	30,5	12

P33802

Cuchara perforada de madera /
Wooden slotted spoon /
 Cuillère à fente en bois /
 Perforierter Holzlöffel



REF	L cm	
P33.802	30,5	12

P33803

Espátula de madera /
Wooden turner /
 Spatule en bois /
 Holzwender



REF	L cm	
P33.803	30,5	12

P33804

Cuchara para spaghetti de madera /
Wooden spaghetti server /
 Cuillère à spaghetti en bois /
 Holz-Spaghettilöffel



REF	L cm	
P33.804	30,5	1

P33805

Tenedor de mesa de madera /
Wooden one piece fork /
 Fourchette en bois /
 Holz-Tafelgabel



REF	L cm	
P33.805	30,5	1

P33806

Pinza de servicio de madera /
Wooden serving tong /
 Pince de service en bois /
 Holz-Servierzange



REF	L cm	
P33.806	28	1

P33807

Pinza de pan de madera /
Wooden bread spoon /
 Pince à pain en bois /
 Holz-Brotzange



REF	L cm	
P33.807	25,5	1

P33808

Servidor de ensalada de madera /
Wooden salad hands /
 Serveur salade en bois /
 Holz-Salatbesteck



Pack: 2 u.

REF	L cm	
P33.808	17,5	1

P33809

Cuchillo de madera /
Wooden knife /
 Couteau en bois /
 Holzmesser



REF	L cm	
P33.809	17,5	1



P358

Pinza buffet BPA Free color / Coloured BPA Free utility tong /
Pince buffet SANBPA en couleurs / Farbige BPA Free buffetzangen



REF	L cm	Transp. Clear	Blanco White Blanc Weiss	Rojo Red Rouge Rot	Negro Black Noir Schwarz	
P358	23	0	1	2	7	1

REF358 + L + COLOR

46926

Pinza servicio / Serving tong /
Pince de service / Servierzange



REF	L cm	
46926	21	12

46938

Pinza buffet / Buffet tong /
Pince à buffet / Büffetzange



REF	L cm	
46938	30,5	6

BUFFET ACCESSORIOS /
 BUFFET ACCESSORIES /
 BUFFET ACCESSOIRES

P359 **Pinza de servicio / Serving tong /**
Pince de service / Servierzange



REF	L cm	
P359.000	24	1

P353 **Pinza ensalada / Salad tong /**
Pince à salade / Salatzange



REF	L cm	
P353.000	26,5	1

46928 **Pinza pan / Bread tong /**
Pince à pain / Brotzange



REF	L cm	
46928	23,5	12

P606 **Pinza pan / Bread tong /**
Pince à pain / Brotzange



REF	L cm	
P606.000	25	1

P605 **Pinza pasta / Pasta tong /**
Pince à pâtes / Nudلزange



REF	L cm	
P605.000	24	1

P351 **Pinza spaghetti / Spaghetti tong /**
Pince à spaghetti / Spaghettizange



REF	L cm	
P351.000	19	12

P352 **Pinza repostería / Cake tong /**
Pince à gâteau / Konditoreizange



REF	L cm	
P352.000	18	1

P617 **Pinza anillas / Tong with ring /**
Tong with ring / Zange mit Ringen



REF	L cm	
P617.017	17	1

P618 Pinza hamburguesa / *Burger tong* /
 Pince à "burger" / *Hamburgerzange*



REF	L cm	
P618.000	24	1

46929 Pinza pastelería / *Pastry tong* /
 Pince à pâtisserie / *Gebäckzange*



REF	L cm	
46929	20	24

P615 Cascanueces / *Nut cracker* /
 Casse-noix / *Nussknacker*



REF	L cm	
P615.000	16,5	1

P902 Pinza charcutería / *Butcher's tong* /
 Pince à charcuterie / *Metzgereizange*



REF	L cm	
P902.000	10,5 x 5	1

P389 Pinza para mariscos en aluminio / *Aluminium lobster cracker* /
 Casse-pattes en aluminium / *Meeresfrüchtezange aus Aluminium*



REF	L cm	
P389.000	14	1

Ver productos en / See products on / Voir produits en page / Siehe produkte in

P.
109

PINZAS / TONGS /
PINCES / ZANGEN



P19117

Poste con cinta retráctil /
Barrier with retractable belt /
Poteau dérouleur à sangle /
Pfosten mit einziehbarem rotem Band

Acero inoxidable pintado negro /
Black-painted stainless steel /
Acier inoxydable peint noir /
Edelstahl schwarz lackiert



REF	H cm	Kg	
P19.117	90	7	1

P19114

Poste con cinta retráctil /
Barrier with retractable belt /
Poteau dérouleur à sangle /
Pfosten mit einziehbarem rotem Band

INOX - ST/STEEL
EDELSTAHL

Pulido brillante.
Mirror Polished.
Polissage brillant.
Glänzend poliert.

Cabezal removable.
Detachable head.
Tête amovible.
Kopf abnehmbar.



REF	Color / Colour / Couleur / Farbe	H cm	L cm	Kg	
P19.114N	●	94	200	9	1
P19.114A	●	94	200	9	1
P19.114R	●	94	200	9	1

P19118

Panel información / Information sign /
Panneau information / Informationsschild

Para poste /
For barrier /
Pour poteau /
Pfosten
P19.117



REF	cm	
P19.118	22 x 46	1

P19115

Recambio cabezal / Spare head /
Rechange de sangle / Ersatzkopf

Para poste /
For barrier /
Pour poteau /
Für Pfosten
P19.114



REF	Color / Colour / Couleur / Farbe	L cm	
P19.115-N	●	200	1
P19.115-A	●	200	1
P19.115-R	●	200	1

P19116

Panel información / Information sign /
Panneau information / Informationsschild

Para poste /
For barrier /
Pour poteau /
Für Pfosten
P19.114



REF	cm	
P19.116	21,8 x 32	1

Poste separación acero inoxidable /
St/Steel barrier /

P19100
Poteau acier inoxydable /
Separationspfosten rostfreier Stahl

P19.100
Pulido brillante.
Mirror Polished.
Polissage brillant.
Glänzend poliert.

P19.101
Baño dorado.
Golden coated.
Doré.
Goldbeschichtet.

Cordón no incluido
Belt not included
Cordon non inclus
Seil nicht inklusive

Ref. P19.100

Ref. P19.101



REF	H cm	Kg	
P19.100	95	10,5	1
P19.101	100	10,5	1

Cordón con ganchos cromados /
Belt with chromium-plated ends /

P19105
Cordon à crochets chromés /
Seil mit verchromten Haken



REF	Color / Colour / Couleur / Farbe	L cm	
P19.105	●	150	1
P19.107	●	150	1
P19.103	●	150	1

Cordón con ganchos dorados /
Belt with golden ends /

P19106
Cordon à crochets dorés /
Seil mit vergoldeten Haken



REF	Color / Colour / Couleur / Farbe	L cm	
P19.106	●	150	1
P19.104	●	150	1

Fabricadas con un material plástico especial que no se raya. Marcos de madera resistentes al agua y al sol. Pizarras especialmente diseñadas para el uso de tizas o rotuladores con base de agua.

Produced from special plastic completely anti-scratch material. Solid wood frame double-lacquered. Rain and sunproof. Writing-surfaces specially designed for using water based chalkmarkers.

Fabriqué avec un matériel plastique spécial anti-rayures. Cadres en bois massif. Résistants à la pluie et au soleil. Tableaux spécialement conçus pour l'utilisation des craies ou marqueurs avec base à eau.

Hergestellt aus einem speziellem Plastik, welches nicht verkratzt. Rahmen aus Holz resistent gegen Wasser und Sonne. Spezielles tafeldesign für den gebrauch von Kreide und Filzstiften.

P21000 / P21001 Caballete - Duo



REF	A cm	B cm	
P21.000	75	135	1
P21.001	55	85	1

P21003 Caballete - Uno



REF	A cm	B cm	
P21.003	55	85	1

P2100 Universal



REF	A cm	B cm	
P21.005	50	60	1

P2101 Lucky

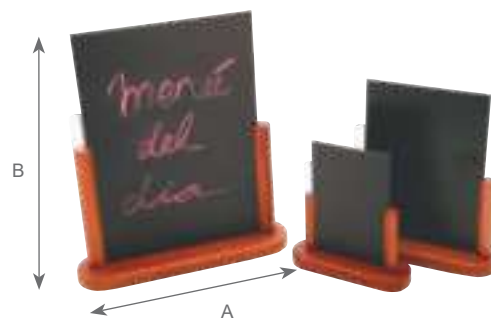

REF	A cm	B cm	
P21.015	10	15	1
P21.016	15	21	1
P21.017	21	30	1

P2102 Basic

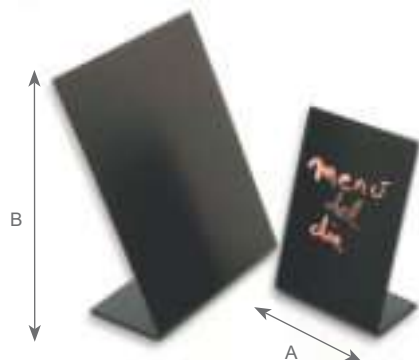

REF	A cm	B cm	
P21.027	10	15	1
P21.028	15	23	1

P21020-26 Marcador tiza / Chalkmarker /
Marqueur / Kreidemarker

Grueso 2-6 mm /
 Widths 2-6 mm /
 Épaisseur 2-6 mm /
 Breite 2-6 mm



REF	Color / Colour / Couleur / Farbe	
P21.020	Blanco / White / Blanc / Weiss	1



SERVICIO DE MESA /
TABLE SERVICE /
ARTS DE TABLE /
TAFELSERVICE

15.1 **MINIATURAS / MINIATURES /** **MINIATURES/ MINIATUREN** **464**

Hierro fundido / Cast iron /
Fonte émaillée / Gusseisen **464**

Aluminio de fundición / Cast aluminium /
Fonte d'aluminium / Aluminiumguss **466**

Acero esmaltado / Enamelled steel /
Acier émaillé / Emailliertem Stahl **466**

15.2 **PRESENTACIÓN DE MESA / TABLE PRESENTATION /** **PRÉSENTATIONTABLE/ TISCHPRÄSENTATION** **467**

Llaunas presentación / Tin plates display /
Plateaux inox présentation / Präsentationstabletts **467**

Tacos y bocadillos presentación / Taco and sandwich tray
Présentation de Tacos et sandwichs / Taco- und Sandwich-Ständer **470**

Pizarras / Slates / Ardoises / Schiefferteln **472**

Bambú natural & madera / Natural bamboo & wooden
Bambou naturel & bois / Naturbambus & holz **474**

Cesta pan / Bread basket /
Corbeille à pain / Brotkorb **477**

Cestas polipropileno / Polypropylene baskets /
Corbeilles polypropylène / Polypropylenkörbe **478**

Manteles individuales / Place mats /
Sets de table / Platzmatten **482**

15.3 **SERVICIO DE MESA / TABLE SERVICE /** **SERVICEDETABLE / TISCHSERVICE** **484**

Molinillos pimienta y sal / Pepper mill-salt mill /
Moulins à poivre et sel / Pfeffer- und Salzmühlen **484**

Salseras / Flared Sauce Cups / Saucières / Gewellte Sossenschalen **485**

Complementos de mesa / Table accessories /
Accessoires de table / Tischaccessoires **486**

Servilletero / Napkin holder / Porte-serviettes / Serviettenspender **489**

Portamenús / Menu holders / Porte-menus / Kartenhalter **490**

Tapas para platos / Plate Covers / Couvercles à assiette / Tellerhauben **491**



Miniaturas hierro fundido / Cast Iron Miniatures / Miniatures fonte émaillée / Miniaturen Gusseisen



Miniaturas en hierro fundido y
esmaltado interior, perfectas
para servicio individual y
presentación.

Enamelled cast iron miniatures
perfect for individual service and
presentations.

Miniatures en fonte émaillée (à
l'intérieur) idéales pour le service
individuel et la présentation.

Miniaturen aus innen emailierten
Gusseisen eignen sich perfekt
für den individuellen Service und
Präsentation.

P23500 Mini sartén / Mini fry pan / Mini poêle ronde / Minibratpfanne



REF	Ø cm	L cm	H cm	
P23.500	10,5	16	2,6	1

P23501 Mini sartén / Mini fry pan / Mini poêle ronde / Minibratpfanne



REF	Ø cm	L cm	H cm	
P23.501	13,5	21	2,5	1

P23502 Mini sartén alta / Mini deep fry pan / Mini poêle ronde haute / Hohe Minibratpfanne



REF	Ø cm	L cm	H cm	
P23.502	14	23,5	3,8	1

P23503 Mini sartén cuadrada / Mini squared fry pan / Mini poêle carrée / Quadratische Minibratpfanne



REF	cm	L cm	H cm	
P23.503	13,6 x 13,6	23,3	3,6	1

P23504 Mini sartén rectangular /
Mini oblong fry pan /
Mini poêle rectangulaire /
Rechteckige Minibratpfanne



REF	cm	L cm	H cm	
P23.504	12,7 x 10,5	18	2,5	1

P23508 Cacerola oval /
Oval casserole /
Mini casserole ovale /
Ovale Kasserolle



REF	cm	H cm	Lts	
P23.508	21,5 x 15,5	6,5	0,60	1

P23505 Mini cacerola con tapa /
Mini round casserole with lid /
Mini cocotte avec couvercle /
Minikasserolle mit Deckel



REF	Ø cm	L cm	H cm	Lts	
P23.505	10	13	7,5	0,20	1

P23507 Cacerola alta con tapa /
High round casserole with lid /
Cocotte haute avec couvercle /
Hohe Kasserolle mit Deckel



REF	Ø cm	H cm	Lts	
P23.507	14	9,5	0,70	1

P23506 Mini fuente oval con tapa /
Mini oval pan with lid /
Mini plateau ovale avec couvercle /
Mini Buffetschale mit Deckel



REF	cm	L cm	H cm	
P23.506	12 x 8	15,5	5,0	1

P23509 Mini fuente oval alta con tapa /
High mini oval pan with lid /
Mini plateau ovale haut avec couvercle /
Ovale hohe Minibuffetschale mit Deckel



REF	cm	H cm	Lts	
P23.509	12,5 x 9,3	7,5	0,25	1

**Miniaturas aluminio de fundición / Cast aluminium Miniatures /
Miniatures fonte d'aluminium / Miniaturen Aluminiumguss****Cazuela baja sin tapa /**
Shallow casserole without lid /
Cocotte sans couvercle /
*Flache Kasserolle ohne Deckel***P141****Fondo torneado /**
Ground base /
Fond dressé /
Gedrechselter
Unterboden

REF	Ø cm	H cm	
P141.014	14	4,0	1
P141.016	16	5,0	1
P141.020	20	5,5	1

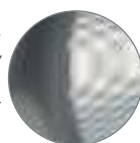
Cazuela alta sin tapa /
Deep casserole without lid /
Braisière sans couvercle /
*Hohe Kasserolle ohne Deckel***P151****Fondo torneado /**
Ground base /
Fond dressé /
Gedrechselter
Unterboden

REF	Ø cm	H cm	
P151.012	12	8,5	1
P151.014	14	8,5	1
P151.016	16	8,0	1

**Miniaturas acero esmaltado / Enamelled steel Miniatures
Miniatures acier émaillé / Miniaturen Emaillierte Stahl****Paellera acero esmaltado /**
Enamelled steel paella pan /
Plat à paella acier émaillé /
*Paellapfanne aus emailliertem Stahl***P995**

REF	Ø cm	Raciones / Portions / Portionen	
P995.010	10	-	1
P995.016	15	-	1

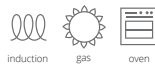
Sartén honda esmaltada con asas /
Deep enamelled fry pan with handles /
Poêle haute avec anses /
*Tiefe Paellapfanne aus emailliertem Stahl mit Griffen***P997**

REF	Ø cm	Lts	
P997.014	14	0,40	1
P997.016	16	0,50	1

Ver productos en / See products on / Voir produits en page / Siehe produkte in**P.**
362**P.**
387**MINIATURAS DE MELAMINA /**
MELAMINE MINIATURES /
MINIATURES DE MÉLANINE /
MELAMIN-MINIATUREN

PRESENTACIÓN DE MESA / TABLE PRESENTATION /
PRÉSENTATIONTABLE/ TISCHPRÄSENTATION



P29680 Pala presentación en inox / *Stainless steel presentation spatula* /
Pelle de présentation en inox / *Präsentierschaufelaus rostfreiem Stahl*



REF	Base / Boden	TOTAL		H cm	📦
	cm	cm	cm		
P29.680	23 x 16	38,6 x 16	11,5	1	



P2965001 Llauna triangular / *Triangular tray* / Plaque triangulaire / *Dreieckiges Blech*



REF	cm	H cm	📦
P29.65001	29 x 29	1,5	1

SERVICIO DE MESA /
TABLE SERVICE /
ARTISSETABLE

**LLAUNAS PRESENTACIÓN /
TIN PLATES DISPLAY /
PLATEAUX INOX PRÉSENTATION /
PRÄSENTATIONSTABLETTES**



P296415 Llauna inox con asas / Stainless steel tray with handles /
Plaque inox avec anses / Edelstahlblech mit Griffen

REF	Base / Podest	TOTAL		📦
	cm	cm	H cm	
P29.6415	22 x 14	25,5 x 14	1,5	1
P29.6430	22 x 14	25,5 x 14	3	1
P29.6515	26,5 x 23	30 x 23	1,5	1
P29.6530	26,5 x 23	30 x 23	3	1
P29.6615	32 x 24	35,5 x 24	1,5	1
P29.6630	32 x 24	35,5 x 24	3	1
P29.6715	32 x 18	35,5 x 18	1,5	1
P29.6730	32 x 18	35,5 x 18	3	1



P296.630



P296.415



P296.515



P296.615



P296.715

P926300 Base de corcho / Cork base / Base en liège / Korkuntersatz

REF	cm	H cm	Compatible con Sustible for Adaptable pour Geeignet für	📦
P92.6300	30 x 19	3	P296415 - P296430	1
P92.6400	34,5 x 28	3	P296515 - P296530	1
P92.6500	40 x 29	3	P296615 - P296630	1
P92.6600	40 x 23	3	P296715 - P296730	1



dishwasher



Ideal para servir en mesa
Ideal for table top service
Idéal pour service de table
Ideal zum servieren am Tisch

ACERO INOXIDABLE / STAINLESS STEEL /
ACIERINOXYDABLE / EDELSTAHL



MADERA / WOOD / BOIS / HOLZ



Ideal para arroces, caracoles y carnes y pescados al horno /
Ideal for baked rice, snails, meats and fish /
Idéal pour des recettes comme paëlla, escargots, pièces de viandes /
Ideal für reisgerichte, schnecken und fleisch und fischspeisen aus dem ofen

*Sólo para placas inducción mantenedoras /
Only for warming induction units /
Uniquement pour plaquesinduction de maintien en température /
Nur für Warmhalte-Induktionsplatten

P29610

Llauna bandeja presentación rectangular con mango /
Sheet pan with wooden tray with handle /
Plateau de présentation avec manche /
Blech Präsentationstablett mit Stiel



REF	LLAUNA		TOTAL		📦
	cm	H cm	cm	H cm	
P29.610	22 x 14	2	34 x 18	3	6

P29600

Llauna bandeja presentación rectangular /
Sheet pan with wooden tray /
Plateau de présentation /
Blech Präsentationstablett



REF	LLAUNA		TOTAL		📦
	cm	H cm	cm	H cm	
P29.600	29,5 x 19,5	2	33 x 23	3	6

P1950

Llauna bandeja gastronorm 1/1 presentación / 1/1 GN sheet pan /
Plateau GN 1/1 de présentation / Blech GN-Tablett 1/1 Präsentation

GN 1/1



REF	LLAUNA		TOTAL	📦
	cm	H cm	L cm	
P195.000	48 x 32	2	52,5	6

P296

Llauna bandeja presentación redonda / Round sheet pan with wooden tray /
Plateau rond de présentation / Blech Präsentationstablettrund



REF	LLAUNA		TOTAL		📦
	Ø cm	H cm	L cm	H cm	
P29.620	20	4,5	31	5,5	6
P29.630	26	4,5	37	5,5	6



Ideal para servir en mesa /
Ideal for table top service /
Idéal pour service de table /
Ideal zum servieren am Tisch

**TACOS Y BOCADILLOS
PRESENTACIÓN /
TACO AND
SANDWICH TRAY
PRÉSENTATION DE
TACOS ET SANDWICHS /
TACO- UND
SANDWICH-STÄNDER**



P41004

Soporte tacos con base de madera / Taco tray with wooden base /
Plateau à tacos avec base en bois / Taco-Halter mit Holzuntersatz

REF	cm	H cm	
P41.004	44 x 10,8	6,5	1



Ver productos en / See products on / Voir produits en page / Siehe produkte in

**P.
368**

BANDEJA 5 COMPARTIMENTOS /
5 - COMPARTMENT BOWL /
BOL 5 COMPARTIMENTS /
SCHALE 5 UNTERTEILUNGEN



**Espacio central ideal para
salsas y dipear.**

Central space ideal for sauces
and dips.

Espace central idéal pour sauces
et tartiner.

Das perfekte Mittelstück für
Sossen und Dips.

P41001

Soporte tacos. 2-3 compartimentos / Taco tray. 2-3 compartments /
Plateau à Tacos 2-3 compartiments / Taco-Halter 2 - 3 Fächer



REF	cm	H cm	
P41.001	21 x 10,2	5	1

P41002

Soporte tacos. 4-5 compartimentos / Taco tray. 4-5 compartments /
Plateau à Tacos 4-5 compartiments / Taco-Halter 4 - 5 Fächer



REF	cm	H cm	
P41.002	36 x 10,2	5	1



P41003

Soporte bocadillos. 7 compartimentos / Sandwich tray. 7 compartments /
Plateau à sandwichs. 7 compartiments / Sandwich-Halter 7 Fächer



REF	cm	H cm	
P41.003	44 x 10,8	6,5	1

15.2 PRESENTACIÓN DE MESA / TABLE PRESENTATION / PRÉSENTATIONTABLE / TISCHPRÄSENTATION



PIZARRAS / SLATES / ARDOISES/ SCHIEFERPLATTEN

Presentación natural, elegante y exclusiva de platos fríos o calientes.

Natural, elegant and exclusive presentation of cold or hot plates.

Présentation naturelle, élégante et exclusive de plats froids ou chauds.

Naturelle, exclusive und elegante Präsentation von kalten und warmen Speisen.

P28600 Tabla pizarra y acacia / Slate and acacia board / Plateau ardoise et bois / Schieferplatte und Akazie



REF	cm	H cm	
P28.600	33 x 23	1,5	1

P28610 Tabla pizarra y acacia / Slate and acacia board / Plateau ardoise et bois / Schieferplatte und Akazie



REF	cm	L cm	H cm	
P28.610	26 x 18	34	1,5	1

P28620 Tabla pizarra y acacia / Slate and acacia board / Plateau ardoise et bois / Schieferplatte und Akazie



REF	Ø cm	L cm	H cm	
P28.620	21,0	31	1,5	1
P28.621	26,5	37	1,5	1

Ver productos en / See products on / Voir produits en page / Siehe produkte in

P. 90

BANDEJA PRESENTACIÓN /
 DISPLAY TRAY /
 PLATEAU PRÉSENTATION /
 PRÄSENTATIONSSCHALE



PRESENTACIÓN DE MESA / TABLE PRESENTATION / PRÉSENTATION TABLE / TISCHPRÄSENTATION

PIZARRAS / SLATES / ARDOISES / SCHIEFFERTFELN

Cantos pulidos / Polished edges / Coins biseautés / Abgeschrägte ecken

Pies espumados / Rubber feet / Pieds mousse / Schaumstofffüsse

**4-5 mm
Espesor / Thickness / Epaisseur / Dicke**

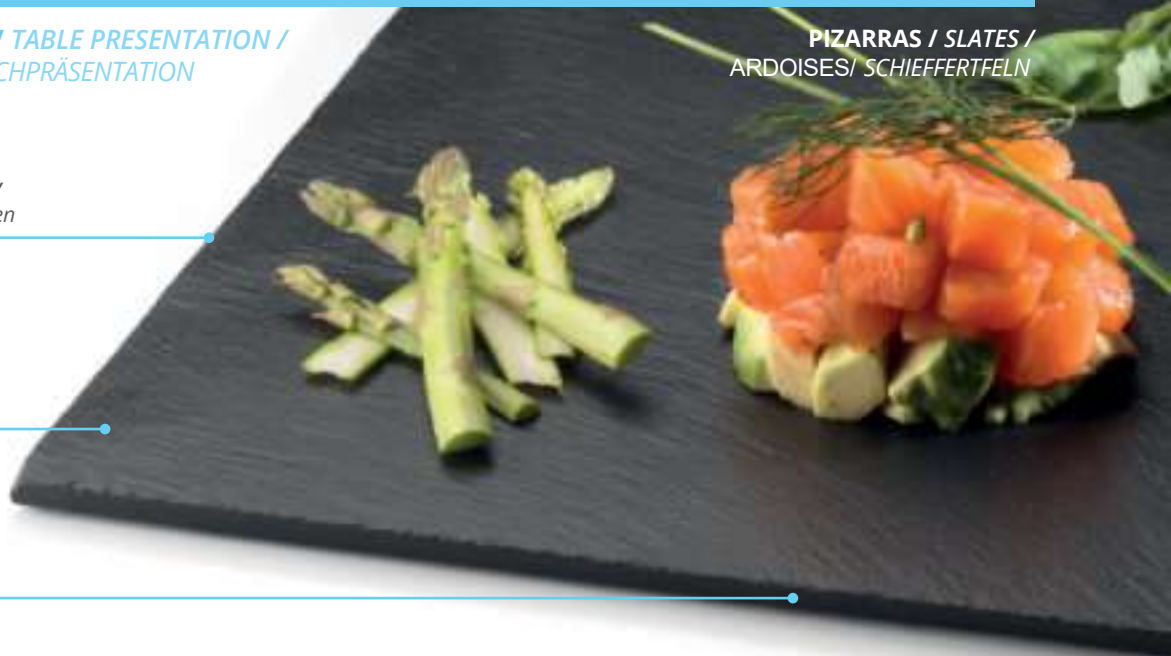

P28202 Pizarra presentación / Slate serving tray / Ardoise presentation / Schieferplatte



REF	cm	
P28.202	20 x 20	24
P28.252	25 x 25	16
P28.303	30 x 30	12
P28.302	30 x 20	16
P28.403	40 x 30	10

P28501 Pizarra presentación / Slate serving tray / Ardoise presentation / Schieferplatte



REF	cm	
P28.501	25 x 25	1
P28.502	30 x 30	1
P28.503	30 x 20	1
P28.504	40 x 30	1

P28505 Pizarra presentación / Slate serving tray / Ardoise presentation / Schieferplatte



REF	Ø cm	
P28.505	20	1
P28.506	30	1

Pies espumados / Rubber feet / Pieds mousse / Schaumstofffüsse

Superficie rústica / Rough surface / Surface rustique / Rustikale oberfläche

Cantos naturales / Natural edges / Coins naturels / Natürliche ecken

**5-6 mm
Espesor / Thickness / Epaisseur / Dicke**



15.2 PRESENTACIÓN DE MESA / TABLE PRESENTATION / PRÉSENTATIONTABLE/ TISCHPRÄSENTATION

BAMBÚ NATURAL & MADERA / NATURAL BAMBOO & WOOD / BAMBOU NATUREL & BOIS / NATURBAMBUS & HOLZ

NATURAL
FIBERS

Gama presentación bambú natural para los más exigentes.

Natural bamboo presentation range for the most demanding hotels and restaurants.

Gamme de présentation bambou naturel plus exigeants.

Präsentationsreihe naturBambus für den höchsten Anspruch.



P10051 Tabla bambú presentación sushi / Bamboo sushi board / Planche bamboú présentation sushi / Bambus Sushitisch



REF	cm	H cm	
P100.511	24 x 15	3,0	24
P100.512	27 x 18	3,0	24

P10052 Tabla curvada bambú sushi / Curved bamboo sushi board / Planche incurvée bambou présentation sushi / Gebogener Bambus Sushitisch



REF	cm	H cm	
P100.520	21 x 12	2,5	36
P100.521	24 x 15	3,0	24
P100.522	27 x 18	3,0	24

P10060 Barco presentación sushi / Sushi boat presentation / Bateau présentation sushi / PräsentationsSushi-Boot



REF	cm	H cm	
P100.600	50 x 20	31,0	6
P100.601	70 x 25,5	45,0	6

P10054 Vaporera bambú redonda / Round bamboo steamer /
Cuit vapeur bambou rond / Runder Bambus Dampfgarer

Sin tapa / Without lid / Sans couvercle / Ohne Deckel



REF	cm	H cm	
P100.540	10	4,0	375
P100.541	13	5,0	224
P100.542	15	5,0	144
P100.543	21	5,0	72
P100.544	27	5,5	44

P10055 Tapa vaporera redonda / Round steamer lid /
Couvercle cuit vapeur rond / Runder Dampfgarerdeckel



REF	Ø cm	H cm	
P100.550	10	3,0	500
P100.551	13	3,5	272
P100.552	15	3,5	204
P100.553	21	4,0	102
P100.554	27	4,0	60

P10053 Bandeja rectangular presentación sushi / Sushi rectangular tray /
Plateau rectangulaire présentation sushi / Sushi-Tablett, rechteckig



REF	cm	H cm	
P100.530	33 x 22,5	8,0	6
P100.531	42 x 32	8,5	6

P10057 Pinza bambú / Bamboo tong / Pince bambou / Bambuszange



REF	L cm	
P100.570	20,0	780
P100.571	25,5	504
P100.572	30,0	444



CESTA PAN / BREAD BASKET / CORBEILLE À PAIN / BROTKORB

**BEST
SELLER**

P100816 Cesta pan marrón / Brown bread basket / Corbeille à pain marron / Brauner Brotkorb

Papel / Paper /
Papier / Papier



P100.807

REF	cm	H cm	
P100.816	13,0 x 13,0	15	12
P100.807	17,5 x 17,5	15	12
P100.836	26,5 x 26,5	12	12

Se puede lavar / Washable/
Peuvent se laver / Kann gewaschen werden

P100808 Cesta pan gris / Grey bread basket / Corbeille à pain gris / Grauer Brotkorb

Papel / Paper /
Papier / Papier



P100.808



P100.838

REF	cm	H cm	
P100.808	13,0 x 13,0	15	12
P100.827	17,5 x 17,5	15	12
P100.838	26,5 x 26,5	12	12

Se puede lavar / Washable/
Peuvent se laver / Kann gewaschen werden

P100817 Cesta pan negra / Black bread basket / Corbeille à pain noir / Schwarz Brotkorb

Papel / Paper /
Papier / Papier



P100.826

REF	cm	H cm	
P100.817	13,0 x 13,0	15	12
P100.826	17,5 x 17,5	15	12
P100.837	26,5 x 26,5	12	12

Se puede lavar / Washable/
Peuvent se laver / Kann gewaschen werden

P10074 Cesta pan / Bread basket / Corbeille à pain / Brotkorb

REF	cm	H cm	
P100.740	29 x 29	47,5	12
P100.741	36 x 30	21 / 39	6
P100.742	Ø 29	21 / 39	6
P100.780	Ø 35	35	12







P100.740

P100.741

P100.742

P100.780

P10075 Cesta redonda inclinada / Slated bread basket / Corbeille ronde inclinée / Schräger runder Korb

REF		Ø cm	H cm	
P100.754		36	10 / 20	6
P100.755		40	13 / 23	6



P10076 Cesta rectangular inclinada / Slated rectangular basket /
Corbeille rectangulaire inclinée / Schräger rechteckiger Korb

REF	cm	H cm	
P100.760	40 x 28	6 / 10	12
P100.761	58 x 38	8 / 12	6



P10077 Cesta rectangular dos compartimentos / Two compartment rectangular basket /
Corbeille rectangulaire deux compartiments / Rechteckiger Korb zwei Unterteilungen

REF	cm	H cm	
P100.770	49 x 31	10 / 14,3	6



P10079 Cesta redonda / Round basket / Corbeille ronde / Runder Korb

REF	Ø cm	H cm	
P100.792	24	5,5	60



P10080 Cesta redonda / Round basket / Corbeille ronde / Runder Korb

REF	Ø cm	H cm	
P100.803	18	6,0	48
P100.804	23	6,0	48
P100.805	25	6,0	48



P10081 / P10082 Cesta redonda / Round basket / Corbeille ronde / Runder Korb

REF	Ø cm	H cm	
P100.813	18,5	6,0	84
P100.814	23	6,0	84
P100.820	18,5	6,0	84
P100.821	23	6,0	84



P10090 Cesta oval / Oval basket / Corbeille ovale / Ovaler Korb

REF	cm	H cm	
P100.900	30 x 23,5	7,5	36



P10084 Cesta rectangular /
Rectangular basket /
Corbeille rectangulaire /
Rechteckiger Korb



REF	cm	H cm	
P100.840	21,5 x 18	8,0	84
P100.841	26 x 20	7,5	48

P10085 Cesta rectangular /
Rectangular basket /
Corbeille rectangulaire /
Rechteckiger Korb



REF	cm	H cm	
P100.851	40 x 28,5	7,0	24

P10086 Cesta rectangular /
Rectangular basket /
Corbeille rectangulaire /
Rechteckiger Korb



REF	cm	H cm	
P100.860	37 x 27	7,0	24
P100.861	46 x 34	7,0	24
P100.862	46 x 34	12,0	12

P10087 Cesta rectangular /
Rectangular basket /
Corbeille rectangulaire /
Rechteckiger Korb



REF	cm	H cm	
P100.871	42 x 30	7,0	24

P10088 Cesta oval / Oval basket /
Corbeille ovale / Ovaler Korb



REF	cm	H cm	
P100.880	18 x 12	6,5	60
P100.881	23,5 x 15	7,0	60
P100.882	28 x 14,5	7,5	36

P10089 Cesta oval / Oval basket /
Corbeille ovale / Ovaler Korb



REF	cm	H cm	
P100.890	19 x 13	7,0	48
P100.891	25 x 15	8,0	60
P100.892	29 x 19	10,0	60

P10093 Cesta para cubiertos / Cutlery dispenser / Corbeille à couverts / Besteckkorb



REF	cm	H cm	
P100.931	30 x 11	7,0	96
P100.932	30 x 11	7,0	96

P10094 Cesta para cubiertos / Cutlery dispenser / Corbeille à couverts / Besteckkorb



REF	Ø cm	H cm	
P100.940	13	14,0	36

P10095 Cesta buffet rectangular / Rectangular buffet basket /
Corbeille rectangulaire buffet / Rechteckiger Buffetkorb

GN 1/1



REF	cm	TOTAL H cm	BASE H cm	
P100.950	53 x 31,5	26,0	8,5	12
P100.951	53 x 31,5	26,0	8,5	12
P100.955*				6

*Tapa / Lid / Couvercle / Deckel

Policarbonato / Polycarbonate
Polycarbonate / Polycarbonat

P10096 Cesta buffet redonda / Round buffet basket / Corbeille ronde buffet / Runder Buffetkorb



REF	Ø cm	H cm	
P100.960	40	30	24
P100.965*			6

*Tapa / Lid / Couvercle / Deckel

Policarbonato / Polycarbonate
Polycarbonate / Polycarbonat

MANTELES INDIVIDUALES / PLACE MATS / SETS DE TABLE / PLATZMATTEN



Manteles individuales fabricados en PVC + poliéster. Para su limpieza se aconseja usar una esponja o trapo húmedo.

Place mats made of PVC + polyester. To clean please use a damp sponge or cloth

Sets de table fabriqués en PVC + polyester. Nettoyer à l'aide d'une éponge ou un chiffon humide.

Individuelle PlatzMatten Hergestellt aus PVC + Polyester. Für die einfache Reinigung empfehlen Wir einen Schwamm oder ein Feuchtes tuch.

P92605 Manteles individuales DECO / DECO place mats / Sets de table DECO / Individuelle Platzmatten DECO



P926.051



Líneas marrones-negras / Brown&Black Lines / Lignes marrons et noirs / Braune und schwarze Linien



P926.052

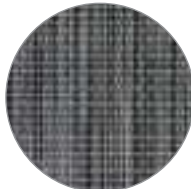

Marrón-negro / Brown&Black / Marron et noir / Braun - Schwarz



P926.053



Negro / Black / Noir / Schwarz

REF	cm	
P926.051	45 x 30	6
P926.052	45 x 30	6
P926.053	45 x 30	6

Precio / Price / Prix / Preis: Pack 6 u.

P9260 Mantel individual trama fina / Place mat fine band / Set de table maille fine / Platzmatte feinmaschig



REF	cm	
P926.006	45 x 30	6
P926.007	45 x 30	6
P926.008	45 x 30	6
P926.009	45 x 30	6

Precio / Price / Prix / Preis: Pack 6 u.

Marrón / Brown /
Marron / Braun



P926.006

Café / Coffee /
Café / Kaffee

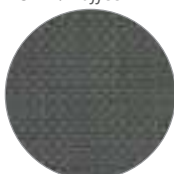

P926.007

Negro-Blanco /
Black&White /
Noir et blanc /
Schwarz-Weiss



P926.008

Verde / Green /
Vert / Grün

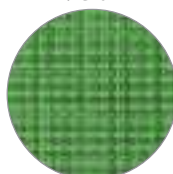

P926.009

P926 Mantel individual trama gruesa / Place mat wide band /
Set de table maille épaisse / Platzmatte grobmaschig



REF	cm	
P926.002	45 x 30	6
P926.003	45 x 30	6
P926.004	45 x 30	6
P926.005	45 x 30	6
P926.010	45 x 30	6
P926.011	45 x 30	6
P926.012	45 x 30	6

Precio / Price / Prix / Preis: Pack 6 u.

Naranja / Orange

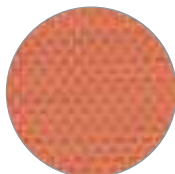

P926.002

Burdeos /
Burgundy /
Bordeaux /
Bordeauxrot

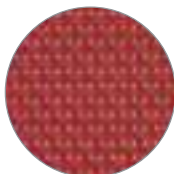

P926.003

Negro /
Black /
Noir /
Schwarz

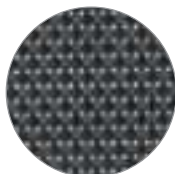

P926.004

Marrón-Negro /
Brown&Black /
Marron et noir /
Braun-Schwarz

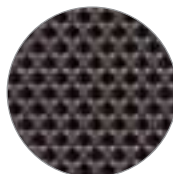

P926.005

Marrón-Plata /
Brown&Silver /
Marron Et Argent /
Braun Versilbert

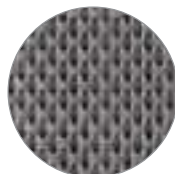

P926.010

Marrón-Dorado /
Brown&Gold /
Marron Et Doré /
Braun-Vergoldet

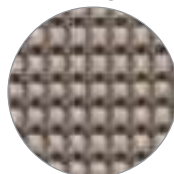

P926.011

Plateado /
Silver /
Argent /
Versilbert

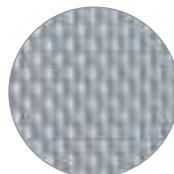

P926.012



P96700 Molinillos pimienta y sal. Madera / Pepper mill-salt mill. Wooden /
Moulins à poivre et sel. Bois / Pfeffer- und Salzmühlen. Holz



REF	H cm	
P967.007	12,5	1
P967.008	15,0	1
P967.009	19,5	1

P967 Molinillos pimienta y sal. Acrílico / Pepper mill-salt mill. Acrylic /
Moulins à poivre et sel. Acrylique / Pfeffer- und Salzmühlen. Acryl.



	REF	Tipo / Type	H cm	
A	P967.001	A	15,5	1
	P967.002	A	20,0	1
	P967.003	A	23,0	1
B	P967.004	B	15,5	1
	P967.005	B	20,0	1
	P967.006	B	23,0	1

Salseras / Flared Sauce Cups / Saucières / Gewellte Sossenschalen

Exterior brillante e interior satinado. Retiene la temperatura durante un tiempo más prolongado que los recipientes de plástico o melamina.

Mirror-finished outside, satin-finished inside. Retains temperature longer (than plastic or melamine). Flared design is attractive, and allows for easier dipping or pouring.

Ultra-brillant à l'extérieur ; satiné à l'intérieur. Retient la chaleur plus longtemps que le plastique ou la mélamine. Forme évasée attrayante ; plus facile pour tremper ou verser.

Hochglanzpoliertes Äußeres, mattpoliertes Inneres. Konserviert die Temperatur länger (als Plastik oder Melamin). Design mit nach oben zunehmendem Durchmesser ist attraktiv und ermöglicht ein einfacheres Eintauchen und Ausgießen.

46714 / 46716 Recipiente para salsas / Flared sauce cup / Saucière évasée / Soßenbecher

INOX - ST/STEEL
EDELSTAHL



REF	Ø cm	H cm	ml	
46714	7,6	4,1	118	12
46716	9,5	4,6	177	12

P333 Salsera / Gravy boat / Saucière / Sossenkännchen



REF	L	
P333.010	0,10	1
P333.020	0,20	1
P333.035	0,35	1

P623 Portasalados o portasalsas / Snack bowl set or sauce bowl set / Ensemble bols pour snacks ou sauces / Snack- oder Sossenständer



REF	UNI.	Ø cm/U	ml/U	
P623.003	3	9	200	1

P2440 Mini cubo / Mini bucket / Mini seau / Minieimer

INOX - ST/STEEL
EDELSTAHL



REF	Ø cm	H cm	L	
P24.407	7,5	6,5	0,15	6
P24.409	9,0	8,5	0,32	6

BCT6860B Sistema avisador de clientes / TClient calling system / Système d'avertisseur clients / Gäste-Meldesystem



REF	REF
BCT6860B	1

Diez discos inalámbricos recargables que se iluminan, vibran y emiten sonidos para avisar al cliente de que debe recoger su pedido, evitando colas y aglomeraciones.

Ten wireless rechargeable discs, which light up, vibrate and beep to notify the customer that their order is ready. Avoiding queues and gatherings.

Dix avertisseurs sans fils rechargeables qui clignotent, vibrent et émettent des bips sonores pour avertir nos clients que leurs commandes sont prêtes. Ils évitent les agglutinations et les queues inutiles.

Zehn wiederaufladbare drahtlose Discs zur Vermeidung von Warteschlangen und Menschenansammlungen, die aufleuchten, vibrieren und Signale abgeben, um Gästen zu melden, dass sie ihre Bestellungen abholen können.

P630 Soporte para número "banquete" / Number card holder / Support numéro "banquet" / Bankettnummerhalter



REF	H cm	
P630.010	10	1
P630.020	20	1
P630.030	30	1
P630.040	40	1

P632 Número de mesa / Table number / Numéro de table / Tischnummer

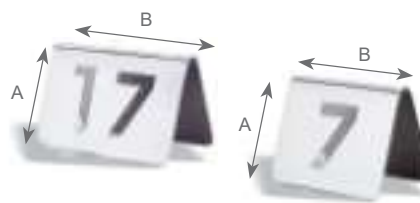

N. 1 - N. 30
 ** número de 2 dígitos. ** number with 2 digits. ** numero de 2 chiffres. ** number with 2 digits.
 * número de 1 dígito. * number with 1 digit. * numero d'un seul chiffre. * number with 1 digit.

REF	A x B cm	
P632.00 + NUM*	5,6 x 6,4	1
P632.0 + NUM**	5,6 x 7,6	1

P633 Placa "Reservado" / "Reserved" table sign / Plaque "reserve" / "Reserviert" Schild

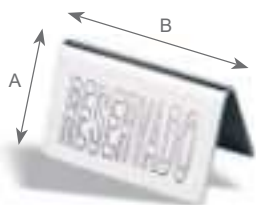

REF	Text	A x B cm	
P633.000	RESERVADO	5 x 10	1
P633.002	RESERVED	5 x 10	1
P633.003	RESERVE	5 x 10	1

P634 Placa "Prohibido fumar" / "Non-smoking" sign / Plaque "Défense de fumer" / "Nichtraucher" Schild



REF	A x B cm	
P634.000	5,6 x 7,6	1

P969 Soporte elevador / Stand for tray /
Support pour plateau / Ständerfür platte



REF	Ø cm	H cm	
P969.000	25 / 20	19,0	1

P9681 Pincho / Skewer /
Brochette / Spiess

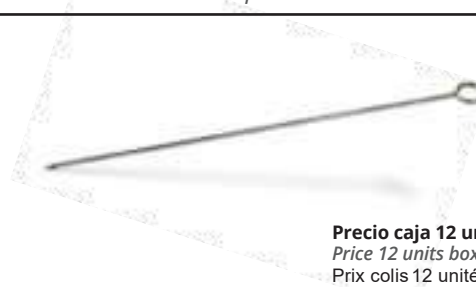

Precio caja 12 unidades.
Price 12 units box.
Prix colis 12 unités.
Preis Kiste 12 Teile.

REF	L cm	
P968.125	25	12
P968.130	30	12
P968.135	35	12

P968 Porta pinchos / Carry-skewers /
Porte-brochettes / Spiesshalter



REF	Ø cm	H cm	
P968.000	22	46	1

P874 Pinchanotas / Bill spike /
Epingle porte-tickets / Bonspiess



REF	Ø cm	H cm	
P874.000	9	22	1

P8621 Bandeja oval antideslizante /
Non slip oval serving tray /
Plateau antidérapant forme ovale /
Ovales Servicetablett Antirutschbeschichtung



Color negro / Black color /
Couleur noir / Farbe Schwarz.

REF	cm	
P862.100	68 x 56	1

P863 Soporte para bandejas de gran tamaño /
Large tray holder /
Support pour grands plateaux /
Support pour grands plateaux



No incluye bandeja.
Serving tray not included.
Plateau non inclus.
Servicetablett nicht enthalten.

REF	cm	H cm	
P863.000	47 x 47	76,5	1

Papelera sobremesa acero inox /
St/Steel table-tydy /
Receptacle à déchets de table /
Tischabfalleimer rostfreier Stahl

P650

INOX - ST/STEEL
EDELSTAHL



REF	Ø cm	H cm	
P650.000	12	21	1

Pala recogemigas /
Table crumber /
Pelle ramasse-miettes /
Krömmelschaufel

P625

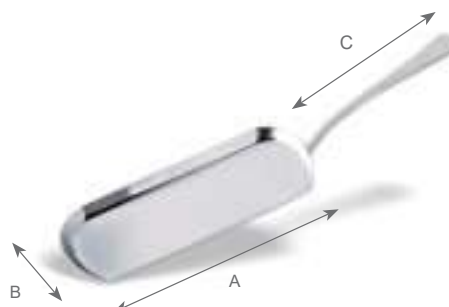

REF	A x B x C cm	
P625.000	18 x 7 x 12,5	1

P638 **Cenicero de agua / Water ashtray /**
Cendrier à eau / Wasseraschenbecher

INOX - ST/STEEL
EDELSTAHL



REF	Ø cm	H cm	
P638.000	11	5,5	1

P639 **Cenicero hondo / Deep ashtray /**
Cendrier profond / Tiefer Aschenbecher

INOX - ST/STEEL
EDELSTAHL



REF	cm	
P639.000	12,5 x 12,5 x 2,5	1

Ver productos en / See products on / Voir produits en page / Siehe produkte in

P.
389

MELAMINA /
MELAMINE /
MÉLAMINE /
MELAMIN



P357 Servilletero /
Napkin holder /
Porte-serviettes /
Serviettenspender

INOX - ST/STEEL
EDELSTAHL



REF 
P357.000 1

P25000 Servilletero madera /
Wooden napkin holder /
Porte-serviettes en bois /
Holz Serviettenspender



REF 
P25.000 1

P25002 Servilletero madera con portamenús /
Wooden napkin holder with menu holder /
Porte-serviettes en bois avec porte-menus /
Holz Serviettenspender mit Kartenhalter

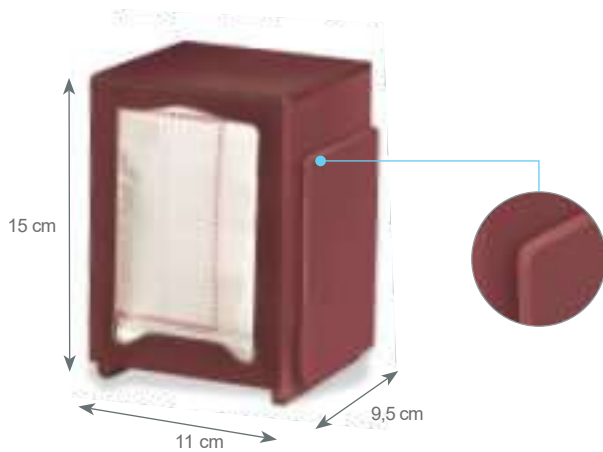

REF 
P25.002 1

P25020 Servilletero madera con portamenús y palillero /
Napkin holder with menu and toothpick holder /
Porte-serviettes avec porte-cure-dents et porte-menus /
Holz Serviettenspender mit Zahnstocher und Kartenhalter

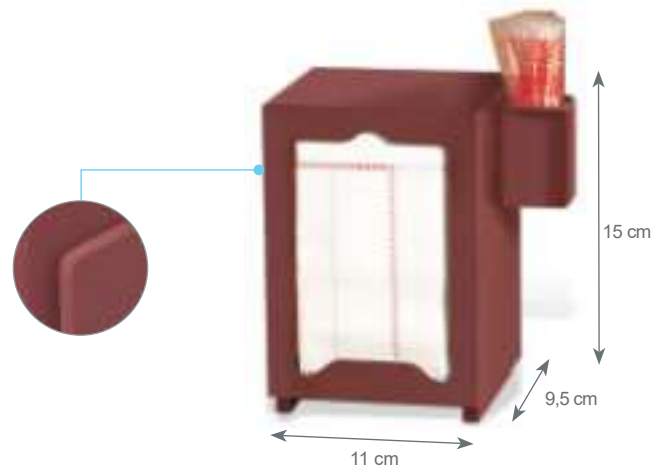

REF 
P25.020 1

15.3 SERVICIO DE MESA / TABLE TOP SERVICE / SERVICEDETABLE / TISCHSERVICE

PORTAMENÚS / MENÚ HOLDER / PORTE-MENUS/ MENÜMAPPE

- Fabricado en PVC.
- Bolsillos en contratapa interior.
- Para hojas DIN A4 y DIN A5.
- Made of PVC.
- Pockets on each back cover.
- For DIN A4 and DIN A5 sheets.

- Fabriqué en PVC.
- Pochesavecouverture intérieure.
- Pour feuilles DIN A4 et DIN A5.
- Hergestellt aus PVC.
- Hüllen im Inneren.
- Für din a4 und din a5.

P2004

Portamenús Elegance / Elegance menu holder /
Porte-Menus Elegance / Eleganz Menümappe



Para 10 páginas: 4 fundas dobles + 2 laterales.

Up to 10 pages: cover back + 4 double inner pages + back cover front.

Pour 10 pages: 4 feuilles plastiques doubles + 2 latérales.

Für 10 Blatt Papier – 2 Plastikhüllen auf Umschlagseiten + 4 Plastikhüllen.

REF	cm	Color / Colour	
P20.041	33 x 24	Burdeos / Burgundy / Bordeaux / Bordeauxrot	1
P20.042	33 x 24	Negro / Black / Noir / Schwarz	1

P20050

Porta blocs Elegance / Elegance Bill holder /
Porte-addition Elegance / Eleganz Blockhalter



REF	cm	Color / Colour	
P20.050	23 x 13	Negro / Black / Noir / Schwarz	1

P636 Portamenús / Menu holder /

Porte-menu de table / Menühalter

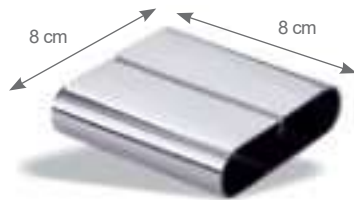

REF	H cm	
P636.000	2	1

P637 / P6371 Platillo cambio / Bill holder /

Porte-addition / Wechselgeldtellerche



REF	cm	
P637.000	15,5 x 11	1
P637.100	21,5 x 12,5	1

P20066 Porta facturas / Bill Holder /

Porte-addition / Rechnungshalter



REF	cm	Color / Colour	
P20.066	24,5 x 17	Negro / Black / Noir / Schwarz	1
P20.069	20 x 13,5	Negro / Black / Noir / Schwarz	1

P635 Portatarjetas / Card holder /

Porte-cartes / Kartenhalter

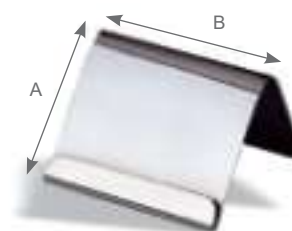

REF	A x B cm	
P635.000	5,2 x 6,2	1

Tapas para platos / Plate Covers / Couverclesà assiette / Tellerhauben

Las tapas para platos mantienen la comida a la temperatura ideal para servir. Se ofrecen con orificio central.

Plate covers keep food at its ideal serving temperature for improved customer satisfaction. Hemmed finger hole.

Les couvre-assiettes maintiennent les aliments à la température idéale de service pour améliorer la satisfaction du client. Trou ourlé pour passer le doigt.

Tellerhauben bewahren die ideale Serviertemperatur der Speisen zur höheren Zufriedenheit der Kunden. Gesäumtes Fingerloch.



62300 Tapas Acero inoxidable para platos / Stainless Steel Plate Covers / Inox couvercles à assiette / Edelstahl-Tellerhauben

INOX - ST/STEEL
EDELSTAHL



REF	Para / For / Pour / Für Ø cm	H cm	
62300	22,9 - 23,2	5,9	12
62303	24,0 - 24,1	5,9	12
62312	26,8 - 27,0	5,9	12
62313	27,1 - 27,3	5,9	12
62315	27,8 - 27,9	5,9	12
62318	28,1 - 28,3	5,9	12
62321	29,1 - 29,2	5,9	12
62326	30,6 - 30,8	5,9	12

El acabado satinado mantiene más tiempo el buen aspecto de las tapas /
Satin-finish keeps covers looking better longer /
Fini satin pour un attrait durable /
Die matte Version behält das schöne Aussehen der Deckel längere Zeit.

Apilable / Stackable / Empilable / Stapelbar

918 Tapa plástico para platos / Plastic Plate Covers / Plastique couvercles à assiette / Kunststoff-Tellerhauben

+ 93°C



REF	Para / For / Pour / Für Ø cm	H cm	
918-13	21,6 - 23,2	6,7	12
1078-13	26,7 - 27,0	7	12

Consultar otras medidas disponibles /
Ask about other available sizes /
Consulter autres dimensions disponibles /
Siehe weitere erhältliche Größen

Transparente / Clear / Transparent

Apilable / Stackable / Empilable / Stapelbar

Lavavajillas / Dishwasher / lave-vaisselle / spülmaschinenfest

Ver productos en / See products on / Voir produits en page / Siehe produkte in

P.
222

BANDEJA ISOTÉRMICA /
ISOTHERMAL TRAY /
PLATEAU ISOTHERME /
ISOTHERMISCHES TABLETT





16.1 BAR 494

Cubiteras / Wine Buckets / Seaux à champagne / Kühler	494
Cocteleria / Cocktail Service / Cocktail / Cocktail-service	498
Alfombras para bar / Bar Mats / Tapis de bar / Barmatten	500
Dispensador de condimentos / Condiment Dispensers / Distributeur de condiments / Beilagenspender	501
Complementos de vino / Wine Complements / Accessoires du vin / Weinzubehör	502
Bandejas / Trays / Plateaux / Tablett	503

16.2 TÉ Y CAFETERÍA / TEA & COFFEE SERVICE / THÉ ET CAFÉTÉRIA / TEE- UND KAFFEESERVICE 504

Planet	504
Cosmos	506
Atlantis	506
Teteras / Tea Pots / Théières / Teekanne	507

16.3 SERVICIO DE BEBIDAS / BEVERAGE SERVICE / SERVICE À BOISSONS / GETRÄNKE-SERVIC 508

Servidores / Servers / Verseuses / Getränke-Servierkannen	508
Jarras / Pitchers / Pichets / Getränkekrüge	510

16.4 DISPENSADORES DE TAPAS Y VASOS / LIDSAVERS AND CUP DISPENSERS / DISTRIBUTEUR DE COUVERCLES ET GOBELETS / DECKELSPENDER & BECHERSPENDER 512



P988400 Cubitera de plástico /
Plastic champagne bucket /
Seau à champagne /
Kunststoff-Sektkühler



REF	Ø cm	H cm	
P988.400	21	21,5	1

P988500 Cubitera bicolor plástico /
Bi-color plastic champagne bucket /
Seau à champagne bicolor /
Sektkühler zweifarbig Kunststoff



REF	Ø cm	H cm	
P988.500	19	21	1

P988600 Cubitera ovalada plástico /
Oval plastic champagne bucket /
Seau à champagne ovale /
Sektkühler ovalförmig Kunststoff



REF	cm	H cm	
P988.600	32,5 x 23,5	22	1

P988700 Cubitera de plástico /
Plastic champagne bucket /
Seau à champagne /
Kunststoff-Sektkühler



REF	cm	H cm	
P988.700	19,5	21	1

Cubitera ovalada plástico /
Oval plastic champagne bucket /
Seau à champagne ovale /
Sektkübler ovalförmig Kunststoff

P988800



REF	cm	H cm	
P988.800	30,5 x 22,5	24,5	1

Cubitera ovalada plástico /
Oval plastic champagne bucket /
Seau à champagne ovale /
Sektkübler ovalförmig Kunststoff

P988900



REF	cm	H cm	
P988.900	44,5 x 41,5	25	1

Cubitera cónica acrílica /
Conical acrylic champagne bucket /
Seau à champagne conique /
Konischer Acrylkühler

P9881



REF	Ø cm	H cm	
P988.100	20	18,5	12

Cubitera ovalada acrílica /
Oval acrylic champagne bucket /
Seau à champagne ovale /
Ovaler Acrylkühler

P9882

*3 BOTELLAS
*3 BOTTLES
*3 BOUTEILLES
*3 FLASCHEN



REF	cm	H cm	
P988.200	27 x 20	20	12
P988.300*	35 x 26	27	6

P990 **Manta enfriadora / Wine cooler /**
Rafrichisseur / Flaschenkühler

Reversible: burdeos y plata /
Reversible: burgundy and silver
Réversible: bordeaux et argenté /
Reversibel: bordeauxrot und silber



REF	cm	
P990.000	35 x 18	16

Soporte de mesa para cubo champán /
Champagne bucket holder /
Support de table pour seau à champagne /
Tischhalterung für Champagnerkühler

P646



Compatible con todos los modelos de cubos champán excepto con:
Suitable with all champagne bucket but:
Adaptable à tous les modèles sauf :
Geeignet für alle Modelle der Champagnerkühler ausser Artikel:
REF. P326

REF	Ø cm	cm	
P646.000	18	52 x 17	1

Cubo champán cónico con anillas /
Conical champagne bucket with rings /
Seau à champagne conique à anneaux /
Konischer

P311F71

INOX - ST/STEEL
EDELSTAHL
18/10



REF	Ø cm	H cm	
P311.071	20	19,5	1

Cubo champán con asas fijas /
Champagne bucket with fixed handles /
Seau à champagne à poignées fixes /
Champagnerkühler mit festen Griffen

P311F2

INOX - ST/STEEL
EDELSTAHL
18/10



REF	Ø cm	H cm	
P311.002	18	19	1

Cubo champán con anillas /
Champagne bucket with rings /
Seau à champagne à anneaux /
Champagnerkühler mit Ringen

P311F6

INOX - ST/STEEL
EDELSTAHL
18/10



REF	Ø cm	H cm	
P311.006	18	19	1

Cubo champán dos botellas /
Champagne bucket two bottles /
Seau à champagne deux bouteilles /
Champagnerkühler zwei Flaschen

P326

INOX - ST/STEEL
EDELSTAHL
18/10



REF	Ø cm	H cm	
P326.000	25	22	1

Cubo champán cónico con asas /
Conical champagne bucket with handles /
Seau à champagne conique avec poignées /
Konischer Champagnerkühler mit Griffen

P9762



REF	Ø cm	H cm	
P976.200	21	20	6

Cubo champán cónico con anillas /
Conical champagne bucket with rings /
Seau à champagne conique à anneaux /
Konischer Champagnerkühler mit Griffen

P9763



REF	Ø cm	H cm	
P976.300	19	19	6

Cubo para hielo con disco separador /
Ice bucket with separative disk /
Seau à glaçons avec disque de séparation /
Eisbehälter mit Seperationsscheibe

P312

INOX - ST/STEEL
EDELSTAHL
18/10



REF	Ø cm	H cm	
P312.000	11	13	1

Enfriador isotérmico (doble pared) /
Double wall insulated cooler /
Rafraîchisseur isotherme double paroi /
Doppelwändiger isothermischer Sektkühler

P974



REF	Ø cm	H cm	
P974.000	10,5	20	1

P310 **Cubitera tipo ensaladera / Ice cube bowl /**
Vasque / Eiskühler Schale-Form



REF	Ø cm	H cm	Lts	
P310.000	40	24,5	13,00	1

P327 **Cubitera tipo ensaladera / Ice cube bowl /**
Vasque / Eiskühler Schale-Form



REF	Ø cm	H cm	Lts	
P327.000	35	25	10,00	1

P3110 **Pie con portacubos acero inox / St/Steel bucket-holder stand /**
Pied porte-seau / Kühlerhalter mit Fuss rostfreier Stahl



P311.004



P311.020

REF	Ø cm	H cm	
P311.004*	18	67,5	1
P311.020**	22	69,0	1

* **Compatible con los modelos / Suitable for references**
Adaptable pour les références / Geeignet für Modelle
P311.F2, P311.F6, P311.F71

** **Para cubitera 2 botellas / For 2 bottles bucket /**
Pour seau à champagne deux bouteilles / Für Kühler 2 Flaschen

COCTELERIA / COCKTAIL SERVICE / COCKTAIL / COCKTAIL-SERVICE



P330 Coctelera / Shaker /
Shakers Cocktail / Shaker



REF	H cm	Lts	
P330.035	18,0	0,35	1
P330.050	20,5	0,50	1
P330.070	23,5	0,70	1

47612 Coctelera / Shaker /
Shakers Cocktail / Shaker

INOX - ST/STEEL
EDELSTAHL



Pulido brillante. *Mirror finished.* **Polissage brillant.** *Hochglanzpolierter.* **La tapa se quita fácilmente.** *Crimped top removes easily.* **La partie supérieure gaufrée se retire facilement.** *Der eingefasste Deckel lässt sich ganz einfach abnehmen.*

REF	L	Ø cm	H cm	
47612	0,71	8,9	22,3	5



Tamaño pequeño perfecto para servicio individual.
Small size perfect for individual service.
Petite taille parfaite pour un service individuel.
Kleine Größe, perfekt für den Einzelservice.

46793 Coctelera / Shaker /
Shakers Cocktail / Shaker



Acero inoxidable brillante. Bases reforzadas /
Acier inoxydable ultra-brillant. Bases renforcées /
Mirror-finished stainless steel. Reinforced bases /
Glänzender Edelstahl. Verstärkte Böden

REF	Ø cm	H cm	ml	
46793	9,2	17,8	887,20	12
46791	8,64	11,4	443,60	12

Ver productos en / See products on /
Voir produits en page / Siehe produkte in

P.
312

TORQ
2.0



P388 Pinza hielo / Ice tong /
Pince à glace / Eiszange



REF	L cm	
P388.018	18,5	12

47104 Pinza hielo / Ice tong /
Pince à glace / Eiszange



REF	L cm	
47104	15,9	12

P3181 Colador gusanillo / Cocktail strainer /
Passoire à cocktail / Cocktailsieb



REF	Ø cm	cm	
P318.100	7,6	11,7 x 15	12

P616 Exprime limones / Lemon squeezer /
Presse citron / Zitronenpresse



REF	Ø cm	
P616.000	17	1

P319 Cuchara batidora / Cocktail spoon /
Cuillère à cocktail / Mixerlöffel



REF	L cm	
P319.000	26,5	1
P319.100	28,0	12

P399 Dosificador licor / Jigger /
Mesure à cocktail / Messbecher



REF	Ø cm	H cm	ml	
P399.000	A 3,7	A 2,8	25	1
	B 4,1	B 5,7	50	

Ver productos en / See products on / Voir produits en page / Siehe produkte in

P.
139

TABLAS DE CORTE /
CUTTING BOARDS /
PLANCHES À DÉCOUPER /
SCHNEIDBRETTER



P26100 Alfombra de bar para escurrido de copas / Bar mat /
Tapis égouttoir pour verres / Thekenabtropfmatten



REF	cm	
P26.100	30 x 30 x 1,20	1



Se pueden conectar unas con otras formando mayores superficies /
They can be connected with each other forming bigger surfaces /
Avec système de liaison pour composer une surface plus grande /
Für grössere Flächen kann man diese Matten mit anderen verbinden.

2331 Alfombra bar rectangular / Service mat / Tapis de service / Serviermatte



REF	cm	
2331-99	45,7 x 30,5 x 1,3	6

Caucho termoplástico flexible /
Flexible thermoplastic rubber /
Caoutchouc thermoplastique flexible /
Flexibles Thermoplast-Gummimaterial

3616 Botella bar / Bar keep / Bouteille de bar / Barflasche



- | | |
|---|------------------------------|
| El juego incluye: | <i>Includes:</i> |
| • 1 cuello | • 1 neck |
| • 1 jarra | • 1 jar |
| • 1 tapa | • 1 lid |
| • 6 picos estándar de diversos colores. | • 6 assorted colored spouts. |

- | | |
|---|---|
| Le kit comprend: | <i>Kit-Inhalt:</i> |
| • 1 goulot | • 1 Halsteil |
| • 1 bombonne | • 1 Gefäß |
| • 1 couvercle | • 1 Deckel |
| • assortiment de 6 becs verseurs standard de couleur. | • 6 Standardausgüsse in verschiedenen Farben. |

REF	L	cm	
3616	0,47	25,7 x 9,20	1
3632	0,95	34,0 x 9,50	1
3648	1,40	38,1 x 16,5	1
3664	1,90	34,90 x 12,7	1
3628	3,80	43,2 x 14,0	1



3628 3664 3648 3632 3616

4741-06 Caja condimentos negra / Condiment Bar Dispenser. Black /
Boîte à condiments / Cocktail Zutaten Spender

PLÁSTICO /
PLASTIC



REF	cm	Lts	Compart.	
4741-06	30,5 x 15,2 x 11,4	1,9	4	1
4743-06	45,7 x 15,2 x 15,6	2,8	6	1



4741-06



4743-06

- No aptos para lavavajillas.
- Tapa policarbonato transparente con cierre automático.
- El diseño de la tapa aumenta la capacidad y permite llenar el artículo.
- Las tapas con orificios permiten mantener el utensilio dentro con la tapa cerrada.
- Las placas enfriadoras se colocan en la parte inferior, manteniendo los condimentos fríos.

- Not dishwasher safe.
- Transparent polycarbonate lid with automatic closure.
- The lid design increases the capacity and allows the item to be filled.
- Lids with holes allow utensils to be stored inside with the lid closed.
- Chiller plates are located on the bottom, keeping the condiments cool.

- Adaptés au lave-vaisselle.
- Couvercle en polycarbonate transparent avec fermeture automatique.
- La conception du couvercle augmente la capacité et permet de remplir l'article.
- Les couvercles perforés permettent de garder l'ustensile à l'intérieur couvercle fermé.
- Les plaques de refroidissement sont placées sur la partie inférieure, en conservant les condiments froids.

- Nicht spülmaschinenfest.
- Transparenter Polycarbonat-Deckel mit automatischem Verschluss.
- Durch das Deckeldesign wird das Fassungsvermögen erhöht und ein Vollfüllen ermöglicht.
- Die Deckel mit Löchern ermöglichen es, Utensilien bei geschlossenem Deckel im Inneren aufzubewahren.
- Zum Kühlhalten der Speisen werden die Kühlplatten an der Unterseite angebracht.

4747 Placa enfriadora para caja condimentos / Refreezable bottle for condiment holder /
Plaque réfrigérante pour Boîte à condiments / Kühlakku

REF	cm	
4747	13,2 x 11,4 x 2,9	6



P3994 Caja condimentos / Condiment holder / Boîte à condiment / Gewürzkiste

INOX - ST/STEEL
EDELSTAHL
18/10

REF	cm	H cm	L / Compart.	
P399.400	30 x 14	8,5	0,45 x 4	1
P399.500	38 x 14	8,5	0,45 x 5	1
P399.600	45 x 14	8,5	0,45 x 6	1



P985 Tapón botella / Bottle stopper /
Bouchon bouteille / Flaschenverschluss



REF	Ø cm	H cm	
P985.000	3	5,5	1

P983 Anillo anti-goteo / Ring stop drop /
Stop gouttes / Antitropfring



REF	Ø cm	H cm	
P983.000	4	2	1

47602 Sacacorchos camarero Pulltap's™ /
Tire-bouchon de serveur Pulltap's™ /
Pulltap's™ Kellnermesser /
Pulltap's® Waiter's Corkscrew



PATENTED

Palanca doble /
Double lever /
Double levier /
Müheloser Korkenzieher

Acero forjado revestido de Teflon®. Hoja de corte interior.
Five turn Teflon® coated forged steel.
Acier forgé revêtu de Teflon® cinq tours.
Geschmiedeter Stahl mit fünfmaliger Teflon®-Beschichtung.

REF	Espiral / Spirale cm	L cm	
47602	5,1	11,7	10

P984 Sacacorchos doble palanca /
Double-lever corkscrew /
Tire-bouchon double levier /
Doppelflüglicher Korkenzieher



REF	cm	
P984.100	17 x 6	12

P9845 Sacacorchos de pared / Wall-mounted corkscrew / Tire-bouchon mur / Korkenzieher Wandmontage



REF	cm	
P984.500	8 x 26 x 32	1

Bandeja camarero en acero inox /
St/Steel round serving tray /
P619 *Plateau limonadier en acier inox /*
Servicetablett aus Rostfreiem Stahl

Pulido brillante /
Mirror finished /
Polissage brillant /
Glänzend poliert



REF	Ø cm	
P619.002	35	1
P619.000	40	1

Bandeja camarero antideslizante /
Non-Skid Trays /
1474 *Plateaux antidérapants /*
Rutschfeste Tablettts

Antideslizante / Non-slip /
Antidérapant / Rutschfeste

Negro / Black /
Noir / Schwarz







REF	Ø cm	
1474-0606	35,6	12
1476-0606	40,6	12

Bandeja de camarero antideslizante /
Non slip serving tray /
P956 *Plateau de service anti-dérapant /*
Servicetablett Antirutschbeschichtung

Color Negro i marrón /
Black and brown colour /
Couleur noir i marron /
Farben Schwarz und Braun



REF		Ø cm	
P956.035		35	1
P956.040		40	1
P956.135		35	1
P956.140		40	1

Mantel anti deslizante /
Anti-Skid Mat Tray Accessories /
1612 *Tapis antidérapant /*
Rutschfeste Matte

Negro / Black /
Noir / Schwarz



REF	cm	
1612-06	41 x 31,8	12

TÉ Y CAFETERÍA / TEA & COFFEE SERVICE / THÉ ET CAFÉTÉRIA / TEE- UND KAFFEESERVICE



P8920B Lechera blanca / White creamer / Crémère blanche / Milchkanne weiß



REF	Lts	
P892.015B	0,15	1
P892.035B	0,35	1
P892.060B	0,60	1

P8920N Lechera negra / Black creamer / Crémère noir / Milchkanne schwarz



REF	Lts	
P892.015N	0,15	1
P892.035N	0,35	1
P892.060N	0,60	1

P8920R Lechera roja / Red creamer / Crémère rouge / Milchkanne rot



REF	Lts	
P892.015R	0,15	1
P892.035R	0,35	1
P892.060R	0,60	1

P890 Tetera / Tea pot with filter / Théière / Teekanne



REF	Lts	
P890.025	0,25	1
P890.035	0,35	1
P890.060	0,60	1

P891 Cafetera / Coffee pot with filter / Cafetière / Kaffeekanne



REF	Lts	
P891.035	0,35	1
P891.060	0,60	1
P891.100	1,00	1

P892 Lechera / Creamer / Crémère / Milchkanne



REF	Lts	
P892.015	0,15	1
P892.025	0,25	1
P892.035	0,35	1
P892.060	0,60	1
P892.100	1,00	1
P892.150	1,50	1
P892.200	2,00	1

P893 Azucarero con tapa / Sugar bowl with lid / Sucrier avec couvercle / Zuckerdose mit Deckel



REF	Lts	
P893.025	0,25	1
P893.035	0,35	1

P885 Tetera / Tea pot with filter / Théière / Teekanne



REF	Lts	
P885.025	0,25	1
P885.040	0,40	1
P885.060	0,60	1

P886 Cafetera / Coffee pot with filter / Cafetière / Kaffeekanne



REF	Lts	
P886.035	0,35	1

P887 Lechera / Creamer / Crémère / Milchkanne



REF	Lts	
P887.015*	0,15	1
P887.025*	0,25	1
P887.060	0,60	1
P887.100	1,00	1

* Diseño especial asas refs. P887.015 y P887.025 para facilitar el manejo / Special handle design for refs. P887015 and P887025 for a better handling.
Spécial design pour anses ref. P887.015 et P887.025 pour améliorer la prise en main / Spezielles Griffdesign für Art. P887.015 und P887.025 für die einfache Handhabung.

P880 Tetera / Tea pot with filter / Théière / Teekanne



REF	Lts	
P880.035	0,35	1
P880.050	0,50	1

P881 Cafetera / Coffee pot with filter / Cafetière / Kaffeekanne



REF	Lts	
P881.100	1,00	1

P882 Lechera / Creamer / Crémère / Milchkanne



REF	Lts	
P882.015	0,15	1
P882.035	0,35	1
P882.100	1,00	1



P23003/
P23004 Tetera "Japón" / "Japan" tea pot /
Théière "Japon" / Teekanne "Japan"



Hierro fundido.
Cast iron.
Fonte en fer.
Gusseisen.

Esmaltado interior.
Enameled inside.
Intérieur émaillé.
Innen emailiert.



Con filtro de acero inoxidable.
With St/Steel filter.
Avec filtre en acier inoxydable.
Mit Edelstahlfilter.

REF	Filtro / Filter / Filtre / Filter Ø cm	Lts	
P23.003	7,0	0,35	1
P23.004	8,0	0,80	12

P23008/
P23009 Tetera "Nipón" / "Nipon" tea pot /
Théière "Nipon" / Teekanne "Nipon"



Hierro fundido.
Cast iron.
Fonte en fer.
Gusseisen.

Esmaltado interior.
Enameled inside.
Intérieur émaillé.
Innen emailiert.



Con filtro de acero inoxidable.
With St/Steel filter.
Avec filtre en acier inoxydable.
Mit Edelstahlfilter.

REF	Filtro / Filter / Filtre / Filter Ø cm	Lts	
P23.008	7,0	0,30	1
P23.009	8,0	0,60	12

P23015 Tetera "Kenya" / "Kenya" tea pot /
Théière "Kenya" / Teekanne "Kenya"



Hierro fundido.
Cast iron.
Fonte en fer.
Gusseisen.

Esmaltado interior.
Enameled inside.
Intérieur émaillé.
Innen emailiert.



Con filtro de acero inoxidable.
With St/Steel filter.
Avec filtre en acier inoxydable.
Mit Edelstahlfilter.

REF	Filtro / Filter / Filtre / Filter Ø cm	Lts	
P23.015	7,0	0,30	1

P896 Jarra para infusiones /
Coffee maker - herbal tea jug /
Pot à infusions /
Kaffee- und Teemacher

 +100°C



Para sacar el cristal es necesario desatornillar.

To remove the glass it is necessary to unscrew.

Pour enlever le verre il est nécessaire de dévisser.



Abschrauben notwendig um das Glas zu entfernen.

REF	Lts	
P896.003	0,35	1
P896.008	0,80	1

**SERVICIO DE BEBIDAS /
BEVERAGE SERVICE /
SERVICE À BOISSONS /
GETRÄNKE-SERVICE**

P898 Jarra termo / Thermo jug / Piche isotherme / Thermoskanne



REF	Color / Colour	Lts	
P898.001		1,0	1
P898.002		1,0	1

**Interior en vidrio /
Inner side in glass /
Interieur en veurre /
Glasinnenraum**

P896 Termo inox con dosificador / Airpot thermo inox with feeder /
Verseuse à pompe thermo inox / Thermoskannemit Spender



REF	Lts	
P896.001	1,9	1
P896.002	3,0	1

**Base rotativa.
Rotative base.
Fond rotatif.
Drehbare Basis.**

**Interior en acero inoxidable
Inner side in St/Steel
Interieur en acier inoxydable
Innen aus rostfreiem Stahl**

P337 Jarra termo luxe / Luxe insulated coffee pot / Pichet isolante luxe / Luxus Thermoskanne



REF	Lts	
P337.030	0,30	1
P337.060	0,60	1
P337.090	0,90	1
P337.150	1,50	1
P337.200	2,00	1

Interior en acero inoxidable
Inner side in St/Steel
Intérieur en acier inoxydable
Innen aus rostfreiem Stahl



Ideal para lavavajillas.
Ideal for dishwasher.
Ideal pour lave-vaisselle.
Ideal für spülmaschinengeeignet.

P895 Servidor termo / Vacuum jug / Verseuse thermo / Servierthermoskanne

Interior en acero inoxidable
Inner side in St/Steel
Intérieur en acier inoxydable
Innen aus rostfreiem Stahl



P895.006

REF	Lts	
P895.006	0,60	1
P895.010	1,00	1
P895.015	1,50	1
P895.020	2,00	1

P894 Termo con dosificador / Air pot / Verseuse à pompe / Thermoskanne mit Spender

Base rotativa.
Rotative base.
Fond rotatif.
Drehbare Basis.

Interior en acero inoxidable
Inner side in St/Steel
Intérieur en acier inoxydable
Innen aus rostfreiem Stahl



REF	Lts	
P894.003	3,00	1
P894.004	4,00	1
P894.005	5,00	1

SWIRLSERVE®

52122 Servidor termo Hot-N-Cold / Hot-N-Cold / Piche isotherme Hot-N-Cold / Heiss-und kaltgetränke-Servierkannen



dishwasher microwave

Aspecto cerámico /
Looks like porcelain /
Ressemble à de la
porcelaine /

Die Außenseite sieht zwar
wie Porzellan



REF	Color / Colour	ml	
52172		591	12
52162		591	12
52170		1.242	12
52160		1.242	12
52174		1.892	6
52164		1.892	6



**Con pestañas de color naranja,
marrón o blanca que permiten
diferenciar fácilmente.**

Avec poussoirs orange, marron
ou blanc pour une meilleure
différenciation.

**With orange, brown,
and white tabs allow
easy differentiation.**

Mit orange, Braun
und Weiss Marke für bessere
Differenzierung.



Jarra bombada con retén /
Server without lid /
P335 **Pichet bombé avec retenu /**
Thermoskanne mit Reserve

INOX - ST/STEEL
EDELSTAHL



REF	Lts	
P335.002	1,80	1

P6464 **Jarra / Server /**
Pichets / Karaffe



Tubo para hielo
Tube for ice
Tube pour les glaçons
Rohr für Eis



Ideal para zumos.
Ideal for juices.
Idéal pour le jus.
Idéal für Säfte.

REF	Lts	
P646.400	1,9	1

P649 **Jarra agua tritan / Carafe tritan / Carafe en tritan / Karaffe Tritan**

EXCLUSIVE



REF	Lts	
P649.050	0,50	1
P649.100	1,00	1

Fabricado en Tritan /
Made of Tritan /
Fabriquée en Tritan /
Hergestellt aus Tritan

P6442 Jarra / Server /
Pichets / Karaffe



+80°C

Fabricada en SAN.
Made of SAN.
Fabriquée en SAN.
Hergestellt in SAN.



EXCLUSIVE

P6441 Jarra de policarbonato /
Polycarbonate server /
Pichet en polycarbonate /
Karaffe aus Polycarbonat



REF	Lts	
P644.200	1,00	1
P644.240	1,40	1
P644.275	1,75	1

REF	Lts	
P644.100	1,00	1
P644.175	1,75	1

P646 Jarra policarbonato apilable sin tapa / Stackable polycarbonate server without lid /
Pichet polycarbonate Empilable sans couvercle / Karaffe aus Polycarbonat ohne Deckel



REF		Lts	
P646.100		1,00	1
P646.103		1,00	1
P646.105		1,00	1
P646.200		2,00	1

P6463 Tapa polipropileno para jarra apilable / Polypropylene lid for stackable Server /
Couvercle polypropylène pour pichet empilable / Polycarbonat Deckel für Karaffe



REF		Lts	
P646.300		1,00	1
P646.310		1,00	1
P646.301		2,00	1

Para jarra policarbonato apilable sin tapa P646.
Fits only on the Stackable polycarbonate servers P646.
Adaptables uniquement sur les pichets polycarbonate empilables P646.
Passt nur auf Polycarbonat Karaffe P646.



LIDSAVER™ 3

DISPENSADORES /
 DISPENSERS /
 DISTRIBUTEURS /
 SAFTSTENTER

SOLUCIONES HIGIÉNICAS

- El sistema de dispensado higiénico previene la contaminación por manipulación excesiva.
- Mantiene las operaciones limpias y ordenadas y responde a las inquietudes de los consumidores en cuanto a salud y bienestar.

BENEFICIOS PARA LOS CLIENTES

- Un ambiente agradable, limpio y ordenado.
- Un servicio notablemente más higiénico fomenta la buena voluntad de los clientes.
- El diseño fácil de usar permite a los clientes llenar bebidas y poner la tapa usando una sola mano.

AHORROS

- Menos pérdidas de tapas significan más ahorro.
- Los mostradores se mantienen libres de pilas de tapas nuevas y tapas rechazadas, desordenadas, lo cual se traduce en menos trabajo de limpieza.



SANITARY SOLUTIONS

- Sanitary dispensing system helps eliminate contamination from excess handling.
- Keeps operations clean and tidy, addressing major consumer concerns about health and well-being.

CUSTOMER BENEFITS

- A welcome environment that is clean and tidy.
- Noticeably more hygienic service fosters customer goodwill.
- Simple-to-use design allows customers to fill beverages and put on a lid using only one hand.

COST SAVINGS

- Fewer wasted lids adds up to more savings.
- Counters are kept free of stacks of new lids and messy rejected lids, requiring less labor for cleanup.



Montaje / Assembly / Montage / Montage

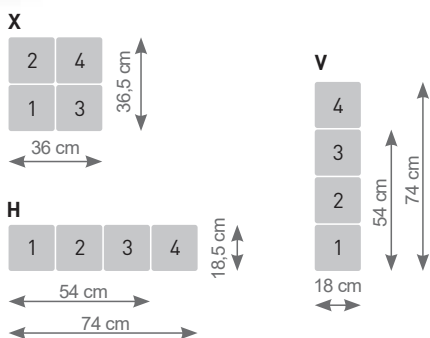

T1 (L)	
Tapas / Lids / Couvertres / Deckels LS03K / LS03M	
Modelo / Model	Código / Code
Berry™ DLT1310 Domed	AB
Berry™ DLT1310SS	AC
Berry™ DLT1402 Domed	AD
Berry™ DLT1402SS	AE
Berry™ DLT1408 Domed	AF
Berry™ DLT1408SS	AG
Dart® 16EL	AJ
Dart® 16LCDH	AK
Dart® 16RCL	AL
Dart® 16SL	AM
Dart® 20SL	AN
Dart® 20SLR	AO
Dart® 32SL	AP
Dart® 32SLR	AQ
Dixie® 9542	AR
Dixie® 955	JY
Dixie® TP9542	AS
Dixie® TP9550	JZ
International Paper LCRS32	AT
International Paper LCTS44	AU
Sweetheart® LGX12R	AY
Solo® 626	AZ
Solo® DL626	BB
Solo® DLR642	BC
Solo® LD16A	BD

T2 (C)		
Dispensador vaso / Cup dispenser / Distributeur de gobelets / Becherspender		
REF	Código / Code	Tipo / Type
INC-80	A	Plástico / Plastic / Plastique / Plastik
CADJ-3	D	Inox / St/Steel / Rostfreier Stahl

T3 (S)		
Dispensador cañas / Straw dispenser / Distributeur de pailles / Strohhalmspender		
REF	Código / Code	
S1	S	

T4 (P)		
Apartado para condimentos / Condiment pocket / Casier à condiments / Gewürzfach		
REF	Código / Code	
P1	P	

Para otros modelos de tapa, consultar a su comercial.
 For other lid models, consult your dealer.
 Pour d'autres modèles de couvercles, consulter votre agent.
 Für andere Modelle mit Deckel, fragen Sie Ihren Händler.

LS03 K Mueble dispensador tapas y vasos / Lids and cups dispenser display / Meuble distributeur couvercles et gobelets / Deckel- und Becherspender



REF+ TYPE+ CODE
 K4V-LLCC-AB-AD-A-A

REF	Tipo / Type	Código / Code
K1	L	T1
K2H	LL	T1 + T1
K2V	LC	T1 + T2
	LP	T1 + T4
	LLL	T1 + T1 + T1
K3H	LCC	T1 + T2 + T2
K3V	LCS	T1 + T2 + T3
	LCP	T1 + T2 + T4
	LCCC	T1 + T2 + T2 + T2
K4H	LCCS	T1 + T2 + T2 + T3
K4V	LCCP	T1 + T2 + T2 + T4
	LLCC	T1 + T1 + T2 + T2
	LCCC	T1 + T2 + T2 + T2
K4X	LCCS	T1 + T2 + T2 + T3
	LCCP	T1 + T2 + T2 + T4
	LLCC	T1 + T1 + T2 + T2

LS03 M Mueble dispensador tapas vertical / Vertical lids dispenser display / Meuble distributeur couvercles vertical / Vertikaler Deckelspender



REF+ CODE
 M2V-LL-AB-AE

REF	Código / Code	H cm
M1-L	+T1	18,5
M2V-LL	+T1 + T1	36,5
M3V-LLL	+T1 + T1 + T1	54,0
M4V-4L	+T1 + T1 + T1 + T1	74,0

LS03 Dispensador encastrable tapas / Lids In-counter dispenser /
Distributeur encastrable couvercles / Einsetzbare Kabinett Deckels



REF	Código / Code	Posiciones / Positions / Positionen	L cm	Para / For / Pour / Für cm	
LS03IB	T1	H	58,5	8,3 - 9,5	1
LS03IVB	T1	V	58,5	8,3 - 9,5	1
LS03PB	T1	H	58,5	9,7 - 12,1	1
LS03PVB	T1	V	58,5	9,7 - 12,1	1
LS03IS18B	T1	H	45,5	8,3 - 9,5	1
LS03PS18B	T1	H	45,5	9,7 - 12,1	1

KDS Mueble dispensador tapas y vasos con organizador / Lids and cups dispenser organizer display /
Meuble distributeur couvercles et gobelets avec organisateur / Deckel- und Becherspender mit Organizer



REF	Código / Code	H cm	
K1LLDS	T1	42,5	1
K2VLCCLDS	T1 + T2	60,5	1
K2VLLLDS	T1 + T1	60,5	1
K3VLCCLDS	T1 + T2 + T2	78,5	1

LS03 J Mueble dispensador mini tapas / Mini lid dispenser display /
Meuble distributeur mini couvercles / Kabinettmöbel Deckels Mini



REF	Tipo / Type	Código / Code	B x H cm
J1	L	T5	13,5 x 19,1
J2V	LL	T5 + T5	13,5 x 36,0
J2H	LL	T5 + T5	28,5 x 19,1
J3V	LLL	T5 + T5 + T5	13,5 x 52,5

REF+ TYPE+ CODE

J2V-LL-M9-N1

LIDSAVER™ 3 MINI

T5 (L)

Tapas / Lids / Couvercles / Deckels
LS03 J/ LS03 M

TIPO / TYPE	Código / Code
Dart® Solo® P150	M9
Dart® Solo® PL2	N1
Natureworkslinego PLA3.085/310	YQ
International Paper LCM-12S	D9
International Paper LCWS12	XE
International Paper LCRS12	EQ
International Paper LHSL-8	XK
Pactiv YLP10C	ZD
Solo® L10BL	ST
Solo® PL4	ZN
Solo® TL3-8	IT
Solo®TLRN38	ZM
Sweetheart® DLX8R	GV
SUP-10D	YT
Quick 6 Oz. BIS-H	YH
WinCup® 6L STYROLID	VG

LS03 M Dispensador encastrable mini tapas / Mini lid In-counter dispenser /
Distributeur encastrable mini couvercles / Einsetzbare Kabinett Deckels Mini



REF	Código / Code	Posiciones / Positions / Positionen	L cm	
LS03MS18B	T5	H	45,5	1
LS03MVS18B	T5	V	45,5	1

Para / For / Pour / Für: 4,4 - 8,3 cm

REF+ CODE

LS03MS18B-M9

Para otros modelos de tapa, consultar a su comercial.

For other lid models, consult your dealer.

Pour d'autres modèles de couvercles, consulter votre agent.

Für andere Modelle mit Deckel, fragen Sie Ihren Händler.

LS03 Dispensador encastrable tapas / Lids In-counter dispenser /
Distributeur encastrable couvercles / Einsetzbare Kabinett Deckels



REF	Código / Code	Posiciones / Positions / Positionen	L cm	Para / For / Für cm	
LS03IB	T1	H	58,5	8,3 - 9,5	1
LS03IVB	T1	V	58,5	8,3 - 9,5	1
LS03PB	T1	H	58,5	9,7 - 12,1	1
LS03PVB	T1	V	58,5	9,7 - 12,1	1
LS03IS18B	T1	H	45,5	8,3 - 9,5	1
LS03PS18B	T1	H	45,5	9,7 - 12,1	1

KDS Mueble dispensador tapas y vasos con organizador / Lids and cups dispenser organizer display /
Meuble distributeur couvercles et gobelets avec organisateur / Deckel- und Becherspender mit Organizer



REF	Código / Code	H cm	
K1LLDS	T1	42,5	1
K2VLCCLDS	T1 + T2	60,5	1
K2VLLLDS	T1 + T1	60,5	1
K3VLCCLDS	T1 + T2 + T2	78,5	1

LS03 J Mueble dispensador mini tapas / Mini lid dispenser display /
Meuble distributeur mini couvercles / Kabinettmöbel Deckels Mini



REF	Tipo / Type	Código / Code	B x H cm
J1	L	T5	13,5 x 19,1
J2V	LL	T5 + T5	13,5 x 36,0
J2H	LL	T5 + T5	28,5 x 19,1
J3V	LLL	T5 + T5 + T5	13,5 x 52,5

REF + TYPE + CODE
J2V-LL-M9-N1

LIDSAVER™ 3 MINI

T5 (L)

Tapas / Lids / Couvercles / Deckels
LS03J/ LS03M: 209,40 €/u

TIPO / TYPE	Código / Code
Dart® Solo® P150	M9
Dart®/Solo® PL2	N1
Natureworkslinego PLA3.085/310	YQ
International Paper LCM-12S	D9
International Paper LCWS12	XE
International Paper LCRS12	EQ
International Paper LHSL-8	XK
Pactiv YLP10C	ZD
Solo® L10BL	ST
Solo® PL4	ZN
Solo® TL3-8	IT
Solo®TLRN38	ZM
Sweetheart® DLX8R	GV
SUP-10D	YT
Quick 6 Oz. BIS-H	YH
WinCup® 6L STYROLID	VG

LS03 M Dispensador encastrable mini tapas / Mini lid In-counter dispenser /
Distributeur encastrable mini couvercles / Einsetzbare Kabinett Deckels Mini



REF	Código / Code	Posiciones / Positions / Positionen	L cm	
LS03MS18B	T5	H	45,5	1
LS03MVS18B	T5	V	45,5	1

Para / For / Pour / Für: 4,4 - 8,3 cm

REF + CODE
LS03MS18B-M9

Para otros modelos de tapa, consultar a su comercial.

For other lid models, consult your dealer.

Pour d'autres modèles de couvercles, consulter votre agent.

Für andere Modelle mit Deckel, fragen Sie Ihren Händler.

INC / CADJ Dispensador vaso / Cup dispenser / Distributeur de gobelets / Becherspender

REF	L cm	Ø cm	Para / For / Pour / Für cm	
INC-80	58,5	13,5	5,7 - 12,1	1
INC-80S18	46,0	13,5	5,7 - 12,1	1
CADJ-1	56,0	13,5	6,4 - 8,9	1
CADJ-2	56,0	14,5	7,6 - 9,8	1
CADJ-3	56,0	17,5	7,6 - 11,7	1

RSCL Dispensador vasos y tapas / Lids and cups dispenser /
Distributeur gobelets et couvercles / Deckel- und Becherspender

REF	Ø cm	H cm	Para / For / Pour / Für cm	
RSCL-4	38	101,5		1
LD2-2	11	65,0	10,5	1
LD3-2	13	65,0	12,4	1
PLC-1	8	65,5	5,7 - 7,3	1
PLC-2	9,5	65,5	7,3 - 8,9	1
PLC-3	11	65,5	8,9 - 10,5	1

PLC-1
PLC-2
PLC-3

RSCL-4

LD2-2
LD3-2**3825** Dispensador de cañas / Straw dispenser / Distributeur de pailles / Strohhalmspender

REF	cm	H cm	Capacidad / Capacity / Capacité / Kapazität	Caña / Straw / Paille / Strohhalm		
			Ø mm	H cm		
3825-06	23 x 10	18	250	6-7	19 - 22	1
3821-06	32 x 14	18	250	7-8	23 - 30,5	1

CTNO Servilletero / Napkin holder / Porte-serviettes / Serviettenspender

REF	cm	H cm	Capacidad / Capacity / Capacité / Kapazität	Servilletas / Napkin / Serviettes / Servietten cm	
CTNO-06*	24,5 x 49,0	38,5	100	12,5 x 16,5 / 11,5-12,5 x 16,5	1
7512-06	30,0 x 20,5	15,5	175	12,5 x 16,5 / 13,5 x 16,5	1
6525-13**	13,5 x 16,5		500	12,5 x 16,5 / 13,5 x 16,5	1



CTNO-06



7512-06



6525-13

*Divisores ajustables / Adjustable dividers / Séparateurs réglables / Verstellbare Trenner
 **Encastrable / Drop in / Encastrable / Einsetzbare

LDS Dispensador de condimentos / Condiment dispensers / Distributeur de condiments / Beilagenspender

REF	cm	H cm	
LDS-4CUP*	29,5 x 53,5	51,5	1
CTC-3X2V**	29,0 x 27,0	41,5	1



LDS-4CUP



CTC-3X2V

*Para tapas y vasos / For lids and cups /
 Pour couvercles et gobelets / Für Deckel und Becher:
 Ø 12 cm

*Divisores ajustables / Adjustable dividers /
 Séparateurs réglables / Verstellbare Trenner

4842 Dispensador auto-servicio / Self-Serve dispenser system /
 Système distributeur libre-service / Spender zur Selbstbedienung

REF	cm	H cm	Para / For / Pour / Für REF.	
4842-06	14,5 x 40,5	35,5		1
4843-06	14,5 x 50,5	35,5		1
4804-06	13,0 x 20,5	11,5	4842-06	1
4806-06	13,0 x 28,5	11,0	4843-06	1



4842-06



4843-06



4804-06



4806-06



Ideal para cubiertos, te, condimentos, sal, pimienta y para todo tipo de productos de mucha rotación.
 Ideal for flatware, tea, condiment packets, salt, pepper, and products with high-volume usage.
 Idéal pour couverts, thé, condiments, sel, poivre et toute sorte de produits à usage intensif.
 Ideal für Besteck, Tee, Gewürze, Salz, Pfeffer und alle Arten von oft verwendeten Produkten.

ARTÍCULO	PÁGINA
ABRELATASINDUSTRIAL.....	136
AFILADORDE CUCHILLOS.....	319
ALCUZA.....	122
ALFOMBRA DE BARPAR ESCURRIRCOPAS.....	500
ALFOMBRAS.....	145
ANILLO ANTI-GOTEO.....	502
ANTIMICROBIAL.....	100-101
APLASTACARNES.....	121
ARAÑA.....	98
ARMARIO CALIENTE.....	335-336
ARO.....	168
ASADORGRILL.....	73-74
AZUCARERO.....	505
BALANZA.....	142
BAMBÚ NATURAL & MADERA.....	474-475
BANDA SELLADORASILICONA.....	202
BANDEJA..... 84-87,90,222, 224, 351, 353, 355-356, 359, 366-375	
BANDEJAALUMINIO ANTIADHERENTE.....	84, 87
BANDEJAAUTO-SERVICEACEROINOX.....	224
BANDEJACAMARERO.....	503
BANDEJAFAST-FOOD.....	224
BANDEJAGASTRONORM.....	84
BANDEJASISOTÉRMICA.....	222
BANDEJAOVAL.....	487
BANDEJAPASTELERÍA.....	86-87, 90, 375
BANDEJAPORTACUBIERTOS.....	225
BANDEJAPRESENTACIÓN.....	375
BANDEJASANTI-DESILIZANTES.....	381, 503
BANDEJASFIBRADE VIDRIO.....	224
BANDEJAS.CUBIC.....	420
BAÑO MARÍA.....	42,329, 334, 442
BARKEEP®.....	500
BARRADE NOTAS.....	122
BASEPIZZA.....	91
BATERIACOLOR.....	49
BATERÍAIDEA.....	50-51
BATERIAPRESENTACIÓN.....	402-407
BATIDOR.....	153
BATIDORA SOBREMESA.....	306
BATIDORASDE VASO.....	311-317
BATIDORASPLANETARIAS.....	306-307
BLACKFIRST.....	74
BLACKPRO.....	72-73
BLACKSERIES.....	56
BOL.....223, 348-349, 351, 354, 357-358, 360, 363-364, 366-367, 369-374	
BOL DOBLE PARED.....	223, 444-447
BOL ESTRIDADOINCLINADO.....	447
BOLSASDE CATERING.....	218-219
BOLSAPARA PIZZAS.....	216-217
BOQUILLA.....	173-176
BOQUILLA POLICARBONATO.....	176
BOTELLABAR.....	500
BRAZOSTRITURADORES.....	308-310
BUFFETCUBIC. CARROBUFFET.....	428-431
BUFFETCUBIC. CUBOSY ESTANTES.....	422-423
BUFFETCUBIC. MUEBLE EXPOSITOR.....	421, 424-425
CACEROLAALUMINIO.....	54
CACEROLACOOOL • LINE.....	48-49
CACEROLAIDEA.....	51

ARTÍCULO	PÁGINA
CACEROLAINOX-PRO.....	40
CACEROLATOPLINE.....	47
CACILLO.....	96,103, 373, 451-455
CAFETERA.....	505-506
CAJACONDIMENTOS.....	501
CAJAGN BAMBU.....	433
CAJAPPE.....	215
CALDERO.....	151
CALENTADORDE PLATOS.....	337
CALENTADORINDUCCIÓN MIRAGE.....	291-292
CALENTADORES.....	329-330
CARROCON GUIAS.....	251-256, 258-259
CARROCON GUIAS,DESMONTABLE.....	251-254
CARROCON GUIAS,ENCASTRABLE.....	252-253
CARROCON SUPERFÍCIEDETRABAJO.....	258
CARRODE MADERA.....	428-431
CARRODE PLÁSTICO.....	246, 251-261
CARRODE SERVICIODESMONTABLE.....	249
CARRODE SERVICIOENALUMINIO.....	246
CARRODE SERVICIOINOXIDABLE.....	247-250
CARRODESCONGELACIÓN.....	255
CARRODESEMBARACE.....	246, 250
CARRODOBLE PARA BANDEJASFAST-FOOD.....	256
CARROGASTRONORMDESCONGELACIÓN.....	255
CARROGUERIDON.....	430
CARROHIELO.....	261
CARROPARA CARGASPESADAS.....	258
CARROPARA CESTAS.....	259
CARROPARA PLATOS AJUSTABLE.....	260
CARROPORTA CUBETASGASTRONORM.....	251-255
CARROPORTACUBIERTOS.....	257, 431
CASCANUECES.....	459
CAYENNE@.....	332-333
CAZOALUMINIO.....	55
CAZOBOMBEADO.....	42, 55
CAZO COOL • LINE.....	49
CAZOIDEA.....	51
CAZOINOX-PRO.....	41-42
CAZO TIPO FRANCÉS.....	41
CAZOSDE MEDIDAS.....	144
CAZUELAALUMINIO FUNDICIÓN.....	56, 466
CAZUELABLACKSERIES.....	56
CEDAZO.....	160
CENICERO.....	389, 488
CENTURY.....	53-55
CEPILLOMETÁLICO.....	122
CESTAGRANDESBANDEJAS.....	242
CESTAPAN.....	476-481
CESTAPARA BANDEJASISOTÉRMICAS.....	242
CESTAPARA CUBIERTOS.....	238, 481
CESTAREJADA.....	432
CESTAUNIVERSAL.....	238
CESTASABIERTAS.....	232-235
CESTASCERRADAS.....	236-237
CESTASPARA PLATOS.....	240-242
CESTASPOLIPROPILENO.....	478-481
CESTILLOPARACUBIERTOS.....	238
CHAFING, ACCESORIOS.....	437, 441
CHAFINGDISH.....	437-440

ARTÍCULO	PÁGINA	ARTÍCULO	PÁGINA
CHAFING DISHESECONOMICOS.....	440	ESCURRIDERA.....	117
CHAFING DISHESINTRIGUE.....	437	ESPÁTULA.....	97,103, 110-112, 154, 451-456
CHAMPAÑERA.....	494-497	ESPÁTULAPARAUNTAR.....	112
CHAMPAÑERA, COMPLEMENTOS.....	502	ESPECIEROS.....	120
CINTA PVC PARA MOUSSE.....	169	ESPUMADERA.....	97-98, 103, 451-454
CLIP DE IDENTIFICACIÓN.....	230, 236-237, 241-242	ESTACIONBUFFETTRINCHANTE.....	333
COCTEL.....	498-499	ESTANTERÍAS.....	263-281
COCTELERA.....	498	EXPOSITORBOLLERIA.....	394-395
COLADOR.....	115-116	EXPOSITORDETARTAS.....	160
COLADORCHINO.....	116	EXPOSITORGASTRONORM.....	375
COLADORGUSANILLO.....	499	EXPOSITORTRESNIVELES.CUBIC.....	418
COLAPASTAS.....	44	EXPOSITORES.....	432-435
COLECTIVIDADES.....	222-225	EXPRIMELIMONES.....	499
CONJUNTOSCOMPLETOSDE ESTANTERIAS.....	268-274	FLANERO.....	170, 179
CONJUNTOS.CUBIC.....	414-417	FLAPIDENTIFICACIÓN.....	229
COOL • LINE.....	48-49, 65	FLAP-RACK®.....	228-229, 232-242
COPA HELADO.....	148	FONDOSPERFORADOSGASTRONORM.....	199-200, 205, 207, 255
CORTADOR/ DESCORAZONADORMANZANAS.....	136	FREIDORA.....	295
CORTADORDE CEBOLLAS.....	131	FUELPARA CHAFINGDISH.....	441
CORTADORDE LECHUGA.....	130	FUENTEFONDUE CHOCOLATE.....	334
CORTADORDE PATATAS FRITAS.....	129	FUENTEHONDA CÓNICA.....	152
CORTADOREN CUBOS.....	133	FUENTE oval.....	349, 352-353, 359, 369, 374, 448, 465
CORTADORSECCIONADOR.....	132	FUNDA PROTECTORADEVINILO.....	261
CORTADORTOMATES.....	135	FUNDAS DESECHABLESPOLIETILENODISPENSADOR.....	258
CORTADORA ELÉCTRICADEFIAMBRES.....	307	GANCHO.....	118
CORTADOR-REBANADOR.....	127-128	GASTRONORMFONDO DIFUSOR.....	203, 347
CORTAHUEVOS.....	136	GASTRONORMINOXIDABLE.....	198-201, 203
CORTAPASTAS.....	155, 167	GASTRONORMMELAMINA.....	380-384
CRÊPERA.....	296	GASTRONORMPOLICARBONATO.....	204-205
CUBERTEROPARACARROSERVICIO.....	250	GASTRONORMPOLIPROPILENO.....	208-209
CUBETA GASTRONORMSIN BPA.....	206-207	GASTRONORMVIOLET.....	210
CUBETASHELADERÍA.....	149	GELLUBRICANTESANITARIO.....	137
CUBITERADE PLÁSTICO.....	494-495	GOFRERAS.....	296-297
CUBO CHAMPÁN.....	494-496	GRILL.....	304
CUBO CON BASE.....	144	GUANTESPROTECCIÓN.....	145
CUBO HIELO.....	497	HELADERÍA.....	148-149, 338-343
CUCHARA.....	98-99, 102-103, 154, 373, 386, 451-456	HERVIDORDE ARROZ.....	296
CUCHARABATIDORA.....	499	HORNOS.....	24-25, 293, 299
CUCHARASERVICIO.....	103, 451-452, 454-456	HORNOSDE BRASA.....	24-25
CUCHILLA/RODILLO DE RECAMBIO.....	136	INDUCCIÓN 3-D MIRAGE.....	322-323
CUCHILLO.....	451, 453, 456	INOX-PRO.....	40-44
CUSCUSERA.....	43	INSERTOS.....	288, 292
DISPENSADORA PRESIÓN.....	119-120	JARRA.....	507, 508-511
DISPENSADORBOLSASTE Y AZÚCAR.CUBIC.....	421	JARRAAGUA.....	510-511
DISPENSADORCON CONTROL DE PORCIONES.....	162	JARRADEMEDIDAS.....	144
DISPENSADORDE CEREALES.....	443	JARRAPARAINFUSIONES.....	507
DISPENSADORDEZUMOS.....	443	JARRAPOLICARBONATO.....	511
DISPENSADORLECHE.....	443	JARRATERMO.....	508-509
DISPENSADORZUMOS.CUBIC.....	417-418	LÁMPARAS MANTENEDORAS.....	331-333
DISPENSADORES.....	162, 418, 443	LECHERA.....	504-506
DOSIFICADORLICOR.....	499	LIBRADOR.....	152
ELEGANCE.....	359	LICUADORAS.....	319
ELEMENTO ELÉCTRICOCHAFINGDISH.....	441	LIDSAVER®.....	512-517
EMBUDO.....	118, 161	LLAUNAS PRESENTACIÓN.....	469
EMBUDO DOSIFICADOR.....	161	MANDOLINAS.....	137
ENFRIADORBOTELLASBUFFET.CUBIC.....	421	MANGAS PASTELERAS.....	171-172
ENFRIADORISOTÉRMICO.....	497	MANOPLA.....	145
ENSALADERAACRÍLICA.....	449	MANTA ENFRIADORA.....	495
ESCAMADOR.....	122	MANTECADORA.....	340-342

ARTÍCULO	PÁGINA
MANTEL ANTIDESLIZANTEPARABANDEJA	503
MANTELESINDIVIDUALES	482-483
MARCADORDE TARTAS	157
MARCADORESTIZA	461
MARCOSPARA BANDEJAS	86
MEDITERRANEAN	360
MELAMINA PRESENTACIÓN	346-389
MELAMINA SLIM	382-383
MESADE CORTE	140
MESITA BUFFET.CUBIC	421
MICRO-ONDAS	293
MINIATURASALUMINIO FUNDICIÓN	466
MINIATURASHIERRO FUNDIDO	464-465
MINIATURAMELAMINA	386-388
MIRAGE®	291, 322-323
MIRAMAR® BATERÍAPRESENTACIÓN	404-405
MIRAMAR® PLANTILLAS	406-407
MOCHILA DE REPARTO	220-221
MOLDE DE CAKE	163-165, 170, 179
MOLDE FORMA CORAZÓN	169
MOLDE FORMALÁGRIMA	169
MOLDE HEXAGONAL	169
MOLDE HUEVO	121
MOLDE MEDIA CAÑA	170
MOLDE NIDO	98
MOLDE OVAL	165, 169
MOLDE PARAPIZZA	91
MOLDE SEMIESFÉRICO	152
MOLDES“FLEXIPAN”	182-189
MOLDES DE SILICONA	177-181
MOLDESPASTELERÍA	163-166, 168-170, 177-189
MOLDESSILICONA 600 X 400	180-181
MOLINILLO PIMIENTA	484
MOLINILLO SAL	484
MULTIMETAL	42, 71
NÚMERO MESA	486
OLLA ALUMINIO	54
OLLA CON GRIFO	44
OLLA COOL • LINE	48-49
OLLA ELÉCTRICA	330
OLLA IDEA	51
OLLA INOX-PRO	40, 44
OLLA TOP LINE	47
PAELLERAACEROESMALTADO	78
PAELLERAALUMINIO	70
PAELLERAINOX-PRO	40
PAELLERATOPLINE	47
PAELLERA VALENCIANA	78
PAELLEROESMALTADO GAS	79
PALA CHIPS	109
PALA FAST-FOOD	111
PALA PASTELES	112, 451-452
PALA PESCADO	97, 111
PALA PIZZA	92
PALA PRESENTACIÓN	376, 467
PANEL INFORMACIÓN	460
PAÑO SILICONA	145
PAPELERASOBREMESA	488
PARRILLAPLANA CON ASALUMINIO	89

ARTÍCULO	PÁGINA
PASAPURÉS	118
PERFILESDIVISORIOS	199, 400
PINCEL	156
PINCHANOTAS	487
PINCHO / BROCHETA	29, 487
PINCHOS. SOPORTEPRESENTACIÓN.CUBIC	419
PINZA	31, 92, 103, 105-109, 454, 456-459, 475, 499
PINZA BUFFET	106-107, 457-458
PINZA CHARCUTERÍA	459
PINZA PARA MARISCO	459
PINZA REPOSTERÍA	458
PINZA SERVICIO	456-458
PINZASPARA EMPLATAR	105
PIZARRAS	461
PIZARRASPRESENTACIÓN	472-473
PLACA“RESERVADO”	486
PLACAADAPTADORAANGULAR	434
PLACACALIENTE	334
PLACAENFRIADORA	442
PLACAPROHIBIDO FUMAR	486
PLACASINDUCCIÓN	284-291
PLANTILLAS	406-407
PLATOS	223, 348-354, 356-358, 360-361, 364, 371-372, 374
PLATOS COLORES	361
PORCIONADORAPRETABLE	102
PORTA CUBIERTOS	225, 257, 420, 431
PORTA PINCHOS	29, 487
PORTAMENÚS	490
PORTASALADOS/ PORTASALSAS	348, 356, 364, 386, 388, 485
PORTATARJETAS	490
POSTESEPARACIÓN	460
PRESENTADORBOLSMELAMINA. CUBIC	423
PRESENTADORCUBETASGN	202, 385
PROCESADORDEALIMENTOS	306-307
PROCESADORVERSÁTILMANUAL	136
PROCESADORESMANUALESDEALIMENTOS	123-137
PROTECTORACRÍLICOANTI-ALIENTO	392
PROTECTORANTI-ALIENTO	392
QUEMADOR ELÉCTRICO	159
RACIONADORDE HELADO	102, 148
RALLADOR	113-114
RASQUETA	111-112, 122, 157
REBANADORADE FRUTASYVERDURAS	131
RECIPIENTEPARASALSAS	348, 356, 364, 386, 388, 485
RECOGEMIGAS	488
RECOGEVERDURAS	140
REJILLASGN	88
REJILLASPASTELERÍA	88, 162
RELOJDECOCINA DIGITAL	142
REMO	122
RETERMALIZADOR	322-329
RETERMALIZADORRETRO	324-325
RETERMALIZADORES/ CALENTADORESALIMENTOS	322-329
RODILLO	155-156
RULETACORTAPIZZAS	111
RUSTIDERA	82-83, 89
SACACORCHOS	502
SACACORCHOSDEPARED	502
SALSERA	485

ARTÍCULO	PÁGINA
SALSERABORDEONDULADO	485
SARTÉN"LIONESA"	77
SARTÉNACEROINOXIDABLE	64-66
SARTÉNALUMINIO	67-70
SARTÉNALUMINIO FUNDICIÓN	72-73
SARTÉNBLACKPRO	72-72
SARTÉNCRÊPES	70, 73-74, 77
SARTÉNHONDA ESMALTADA CON ASAS	78
SARTÉNIDEA	66
SARTÉNMULTIMETAL	71
SARTÉNPARABLINIS	70
SARTÉNSTEELPRO	75
SARTENES	60-77
SARTENESCOOL• LINE	65
SAUTEXALUMINIO	55
SAUTEXINOX-PRO	42
SERVILLETERO	489
SERVILLETERO.CUBIC	421
SOLUCIONESDE DISPENSADO	512-517
SOPERA	449
SOPLETECOCINA	159
SOPORTEMÁRMOL EXHIBICIÓN	378-379
SOPORTEMESABANDEJAMARISCO	487
SOPORTEPARABANDEJASDEGRAN TAMAÑO	487
SOPORTEPARABANDEJASPORTACUBIERTOSGN	225
SOPORTEPARACHINO O EMBUDO	116
SOPORTEPARACUBO CHAMPÁN	497
SOPORTEPARA MANGAS PASTELERAS	172
SOPORTEPARANÚMEROS	486
SOPORTEPARAPINCHOS.CUBIC	419
SOPORTEPARATABLAS DE CORTE	202
SOPORTEPRESENTACIÓNMADERABLANCA	377
SOPORTEPRESENTACIÓNPIZARRA-MÁRMOL	379
SOPORTETAPASGN	202
SPOODLE®	100-101
STEELPRO1921. HIERRODE FUNDICIÓN ULTRALIGEROINDUCCIÓN...75	
STONE	358
SUPERPAN® SUPERSHAPES	398-400
TABLA DE CORTE	138-140
TABLA DE CORTEVIOLET	140
TAPA BATERIA	41, 47, 87
TAPA GN	199, 203, 205, 207-208
TAPA INOX PARA PLATOS	491
TAPA INOX-PRO	41
TAPA PARA CESTA	238
TAPA PLATOS	491
TAPA PLATOSPLÁSTICO	491
TAPA POLINORM®	203, 205, 207-208
TAPA TAZA DESAYUNO	223
TAPAS GN TRANSPARENTES	395
TAPETEDE SILICONA	92
TAPÓN CHAMPÁN	502
TAPÓN UNIVERSAL	502
TAZA	223, 373
TENEDOR	99, 103, 451-453, 456
TERMO CON DOSIFICADOR	508-509
TERMÓMETRO	142-143
TERRACOTA	356-357
TETERA	505-507

ARTÍCULO	PÁGINA
TETERA CON FILTRO	507
TOP LINE	46-47
TOSTADORA	298-302
TRÍPODEPAELLERO	79
T-VERSION	230-235
UTENSILIOSDE SERVICIO	451-459
UTENSILIOSMANGO MADERA	112
VAPORERAINOX-PRO	44
VASO	223, 360
VERSATILMACHINE	133
VIOLET COLLECTION	210
VITRINASPRESENTACIÓN	394-395
WOK ACERO	75
WOK BLACKSERIES	73
WOK INOX	66
WOK MULTIMETAL	71
WOK STEELPRO	75

ITEM	PAGE
ADAPTORBAR.....	199, 400
ADJUSTABLEDISHCADDY.....	260
AIRPOT.....	508-509
ANGLED ADAPTORPLATE.....	434
ANTIMICROBIAL.....	100-101
ANTI-SKID MAT TRAYACCESSORIES.....	503
APPLECORER.....	136
ASHTRAY.....	389, 488
BAIN MARIE.....	42, 329, 334, 442
BAKERYDISPLAYCASES.....	394-395
BARKEEP.....	500
BARKEEP®.....	500
BARMATS.....	500
BARRIER.....	460
BASEFORBURNER.....	79
BASKET,BREAD.....	476-481
BASKET,WIRE.....	432
BILL SPIKE.....	487
BIRD NESTMOULD.....	98
BLACKFIRST.....	74
BLACKPRO.....	72-73
BLACKSERIES.....	56
BLACKSTEELSPANISHPAELLAPAN.....	78
BLACKBOARDS.....	461
BLENDERS.....	311-317
BOILER.....	151
BOWL...223, 348-349, 351, 354, 357-358, 360, 363-364, 366-367, 369-374	
BOWLS, ANGLED BEEHIVE.....	447
BOWLS, DOUBLE WALL INSULATED SERVING.....	223, 444-447
BPA FREE GASTRONORMPAN.....	206-207
BREATH GUARDS, MOBILE.....	392
BREATH GUARDS, MOBILE ACRYLIC.....	392
BRUSH.....	156
BUCKETWITH BASE.....	144
BUCKET-HOLDERSTAND.....	497
BUFFETCUBIC. BUFFETTROLLEY.....	428-431
BUFFETCUBIC. CUBES& SHELVES.....	422-423
BUFFETCUBIC. DISPLAYCASE.....	421, 424-425
BUFFETFUEL.....	441
BUFFETSTATION.....	333
BUFFETWINE COOLER.CUBIC.....	421
BUTTERSPREADER.....	112
CAKEDIVIDER.....	157
CAKEMOULD.....	163-165, 170, 179
CAKESERVER.....	112, 451-452
CAKESTAND.....	160
CAN OPENER.....	136
CARAMELCREAMMOULD.....	170, 179
CARAMELIZER.....	159
CARDHOLDER.....	490
CARRY-SKEWERS.....	29, 487
CASSEROLE.....	56, 466
CASSEROLEBLACKSERIES.....	56
CASTIRON MINIATURE.....	464-465
CATERINGBAGS.....	218-219
CAYENNE®.....	332-333
CAYENNE® WARMERS& RETHERMALIZERS.....	322-329
CENTURY.....	53-55
CEREALDISPENSER.....	443

ITEM	PAGE
CHAFERS.....	437-440
CHAFERSACCESSORIES.....	437, 441
CHAFERS,ECONOMY.....	440
CHAFERS,INTRIGUE®.....	437
CHALKMARKERS.....	461
CHAMPAGNE BUCKET.....	494-496
CHAMPAGNE STOPPER.....	502
CHARCOALOVEN.....	24-25
CHECKMINDER.....	122
CHINESECOLANDER.....	116
CHIP BAGGER.....	109
CHOCOLATEFOUNTAIN.....	334
CLEARGN LIDS.....	395
CLEARINGTROLLEY.....	246, 250
CLIP TAGS.....	230, 236-237, 241-242
COCKTAIL SERVICE.....	498-499
COCKTAIL SPOON.....	499
COCKTAIL STRAINER.....	499
COFFEMAKER.....	507
COFFEPOT.....	505-506
COLANDER.....	115-116
COLANDER.....	117
COLOREDCOOKWARE.....	49
COMPLETEKITSOFSHELVING.....	268-274
CONDIMENT HOLDER.....	501
CONFECTIONERYFUNNEL.....	161
CONICAL SAUCEPAN.....	42, 55
COOL • LINE.....	48-49, 65
COOLING PLATE.....	442
CORKSCREW.....	502
COUNTER-TOPDISPENSER.....	257, 431
COUNTERTOPMIXERS.....	306
COUSCUSSET.....	43
COVERS, PLASTICPLATE.....	491
COVERS, PLATE.....	491
CREAMER.....	504-506
CRÉPEMAKER.....	296
CUBECUTTER.....	133
CUP.....	223, 373
CUTLERYBIN.....	225
CUTLERYDISPENSERFORSERVINGTROLLEY.....	250
CUTTINGBOARD.....	138-140
CUTTINGBOARD TABLE.....	140
CUTTINGBOARD VIOLET.....	140
DELIVERYBACKPACKS.....	220-221
DICER& SLICER.....	127-128
DISHES.....	223, 348-354, 356-358, 360-361, 364, 371-372, 374
DISHES, COLORED.....	361
DISPENSERS.....	162, 418, 443
DISPENSINGSOLUTIONS.....	512-517
DISPLAYCABINET.....	394-395
DISPLAYCOOKWARE.....	402-407
DISPLAYSLATES.....	472-473
DISPLAYSTANDS.....	432-435
DISPLAYTRAY.....	375
DISPLAYERMELAMINE BOWLS. CUBIC.....	423
DISPOSABLECOVER.....	258
DOUBLE COUNTER-TOP CUTLERYDISPENSERGN.....	225
DOUBLE CUTTER.....	155, 167

ITEM	PAGE
DOUBLE FAST-FOODTRAY TROLLEY	256
DOUBLE WALL INSULATED COOLER	497
DREGGERS	120
DROP-IN	288, 292
EGGRING	121
EGGSLICER	136
ELECTRIC HEATING UNIT FOR CHAFING DISH	441
ELECTRIC SLICING MACHINE	307
ELEGANCE	359
ENAMELLED GAS BURNER	79
ENAMELLED STEEL PAELLA PAN	78
EPP BOX	215
FAST-FOOD TURNER	111
FISH SCALER	122
FISH TURNER	97, 111
FLAP IDENTIFICATION	229
FLAP-RACK®	228-229, 232-242
FLARE SAUCE CUPS	485
FLATWARE BASKET	238
FOOD-PROCESSORS	306-307
FORK	99, 103, 451-453, 456
FRENCH FRY CUTTER	129
FRENCH STYLE SAUCE PAN	41
FRUIT & VEGETABLE SLICER	131
FRYPAN "LYONNAISE"	77
FRYPAN ALUMINIUM	67-70
FRYPAN BLACK SERIES	72-72
FRYPAN BLINIS	70
FRYPAN CAST ALUMINIUM	72-73
FRYPAN COOL • LINE	65
FRYPAN CRÊPE	70, 73-74, 77
FRYPAN DEEP ENAMELLED WITH HANDLES	78
FRYPAN IDEA	66
FRYPAN MULTIMETAL	71
FRYPAN ST/STEEL	64-66
FRYPAN STEEL PRO 1921	75
FRYPANS	60-77
FRYER	295
FUNNEL	118, 161
GASTRONORM CONTAINERS (MELAMINE)	380-384
GASTRONORM CONTAINERS (POLYCARBONATE)	204-205
GASTRONORM CONTAINERS (POLYPROPYLENE)	208-209
GASTRONORM FOR DEFROST TROLLEY	255
GASTRONORM SANDWICH BOTTOM	203, 347
GASTRONORM ST/STEEL	198-201, 203
GASTRONORM STAND	375
GASTRONORM VIOLET	210
GLASS	223, 360
GLOVES	145
GN BAMBOO BOX	433
GN TRANSPORT TROLLEY	251-255
GRANITE-SLATE DISPLAYER	379
GRATER	113-114
GRAVY BOAT	485
GRID GN	88
GRID PASTRY	88, 162
GRILL	73-74
GRILL	304
HEARTRING MOULD	169

ITEM	PAGE
HEATING LAMPS	331-333
HEATING PLATE	334
HEMISPHERICAL MOULD	152
HEXAGON MOULD	169
HOOK	118
HOT CUPBOARD	335-336
HOT TRAY WARMER	337
HOT-PLATE WITH HANDLES	89
ICE BUCKET	497
ICE CADDY	261
ICE CREAM CONTAINERS	149
ICE CREAM CUP	148
ICE CREAM SCOOP	102, 148
ICE-CREAM CHURN	340-342
ICE-CREAM PARLOUR	148-149, 338-343
IDEA COOKWARE	50-51
INDUCTION HOBS	284-291
INFORMATION SIGN	460
INOX-PRO	40-44
INSTITUTIONS	222-225
INSULATED COFFEE POT	508-509
ISOTHERMAL TRAY	222
JIGGER	499
JUICE DISPENSER	443
JUICE DISPENSER CUBIC	417-418
JUICE EXTRACTORS	319
KITCHEN BOWL	152
KITCHEN TIMER ALARM	142
KITS CUBIC	414-417
KNIFE	451, 453, 456
KNIFE SHARPENER	319
KNIFE / WHEEL (SPARE PART)	136
LADLE	96, 103, 373, 451-455
LARGE TRAY HOLDER	487
LEMON SQUEEZER	499
LID FOR BREAKFAST CUP	223
LID FOR COOKWARE	41, 47, 87
LID GN	199, 203, 205, 207-208
LID INOX-PRO	41
LID RACKS	238
LID SAVER®	512-517
LOBSTER CRACKER	459
MANDOLINES	137
MANUAL FOOD PROCESSORS	123-137
MARBLE OBLONG DISPLAY PLATE	378-379
MATS	145
MEASURING CUPS	144
MEASURING JUG	144
MEAT BEATER	121
MEDITERRANEAN	360
MELAMINE FOR PRESENTATION	346-389
MELAMINE MINIATURES	386-388
MELAMINE SLIM	382-383
MENU HOLDER	490
METALLIC BRUSH	122
MICRO-WAVES	293
MILK DISPENSER	443
MINIATURE CAST ALUMINIUM	466
MIRAGE®	291, 322-323

ITEM	PAGE
MIRAGE® 3D INDUCTION	322-323
MIRAGE® INDUCTION WARMER	291-292
MIRAMAR® DISPLAY COOKWARE.....	404-405
MIRAMAR® TEMPLATES.....	406-407
MIXERS	306-307
MIXING PADDLE	122
MOULDS“FLEXIPAN”	182-189
MULTIMETAL	42, 71
NAPKIN HOLDER.....	489
NAPKIN HOLDER.CUBIC	421
NATURAL BAMBOO & WOOD	474-475
NON SLIP SERVING TRAY	381, 503
NON-SMOKING SING	486
NON-STICK SILICONEMAT	92
NUMBER CARDHOLDER	486
NUT CRACKER.....	459
OIL POURER	122
ONION CUTTER.....	131
OVAL MOULD	165, 169
OVAL SERVING DISH.....	349, 352-353, 359, 369, 374, 448, 465
OVAL SERVING TRAY	487
OVEN MITT.....	145
OVENS.....	24-25, 293, 299
PAELLAPAN ALUMINIUM	70
PAELLAPAN INOX-PRO ST/STEEL.....	40
PAELLAPAN TOP LINE	47
PAN BAND	202
PASTA COLANDER.....	44
PASTRY BAGS.....	171-172
PASTRY MOULDS	163-166, 168-170, 177-189
PASTRY TORCH.....	159
PEPPERMILL	484
PERFORATED BOTTOMS GASTRONORM.....	199-200, 205, 207, 255
PIZZA BAGS.....	216-217
PIZZA MOULD.....	91
PIZZA PAN	91
PIZZA PEEL.....	92
PIZZA WHEEL.....	111
PLACEMATS.....	482-483
PLASTIC CHAMPAGNE BUCKET	494-495
PLATING TONGS.....	105
POLINORM® LID.....	203, 205, 207-208
POLYCARBONATE TUBE.....	176
POLYPROPYLENE BASKETS	478-481
PORTION CONTROL DISPENSER.....	162
POT-GRABBER.....	145
PVC RIBBON.....	169
RACK (BIG TRAYS).....	242
RACK (CLOSED SYSTEM).....	236-237
RACK (DISHES).....	240-242
RACK (FLATWARE)	238, 481
RACK (ISOTHERMAL TRAYS).....	242
RACK (OPENED SYSTEM)	232-235
RACK (UNIVERSAL).....	238
RAMEKIN.....	348, 356, 364, 386, 388, 485
RECTANGLE FOR BAKING SHEETS	86
RE THERMALIZER RETRO	324-325
RE THERMALIZERS.....	322-329
RICE COOKER.....	296

ITEM	PAGE
RING.....	168
RING STOP DROP	502
ROAST PAN	82-83, 89
ROLLING PIN	155-156
SALAD BOWL	449
SALAD CUTTER.....	130
SALT MILL.....	484
SANITARY GEL LUBRICANT	137
SAUCEPAN ALUMINIUM	55
SAUCEPAN COOL • LINE	49
SAUCEPAN IDEA	51
SAUCEPAN INOX-PRO ST/STEEL.....	41-42
SAUCEPOT ALUMINIUM	54
SAUCEPOT COOL • LINE.....	48-49
SAUCEPOT IDEA.....	51
SAUCEPOT ST/STEEL INOX-PRO.....	40
SAUCEPOT TOP LINE	47
SAUTÉ PAN ALUMINIUM	55
SAUTÉ PAN INOX-PRO	42
SCALE	142
SCOOP	152
SCRAPER	111-112, 122, 157
SERVER.....	507, 508-511
SERVER, POLYCARBONATE.....	511
SERVING PADDLE	376, 467
SERVING TOOLS.....	451-459
SERVING TRAY	503
SERVING TRAY.CUBIC.....	420
SHAKER.....	498
SHELVING.....	263-281
SIEVES	160
SILICON MOULDS	177-181
SILICON MOULDS 600 X 400.....	180-181
SKEVER	29, 487
SKEWERS SERVING SUPPORT.CUBIC	419
SKEWERS SUPPORT.CUBIC	419
SKIMMER	97-98, 103, 451-454
SNACK BOWL SET	348, 356, 364, 386, 388, 485
SOUP KETTLE.....	330
SOUP TOUREEN	449
SPATULA	97, 103, 110-112, 154, 451-456
SPOODLE®	100-101
SPOON	98-99, 102-103, 154, 373, 386, 451-456
SPOONS.....	103, 451-452, 454-456
SQUEEZED ISHER	102
SQUEEZED DISPENSER.....	119-120
ST/STEEL SELF-SERVICE TRAY	224
STAINLESS STEEL PLATE COVERS.....	491
STAND FOR CHINESE COLANDER OR FUNN.....	116
STAND FOR CUTTING BOARDS	202
STAND FOR GN CONTAINERS.....	202, 385
STAND FOR GN LIDS	202
STAND FOR SEAFOOD TRAY.....	487
STEAM POT INOX-PRO	44
STEEL PRO 1921. ULTRALIGHT WEIGHT CAST IRON INDUCTION	75
STICK BLENDERS	308-310
STOCKPOT ALUMINIUM.....	54
STOCKPOT COOL • LINE.....	48-49
STOCKPOT IDEA	51

ITEM	PAGE
STOCKPOT INOX-PRO	40, 44
STOCKPOT TOP LINE ST/STEEL	47
STOCKPOT WITH TAP	44
STONE	358
SUGARBOWL	505
SUPERPAN® SUPERSHAPES	398-400
SUPPORTFORCUTLERYDISPENSER	225, 257, 420, 431
SUPPORTFORPASTRYBAGS	172
TABLE CRUMBER	488
TABLE NUMBER	486
TABLE SING "RESERVED"	486
TABLE-TIDY	488
TEAPOT	505-507
TEAPOT WITH FILTER	507
TEA&SUGARBAGSDISPENSER.CUBIC	421
TEARMOULD	169
TEMPLATES	406-407
TERRACOTA	356-357
THERMOMETER	142-143
THREELEVELSSTAND.CUBIC	418
TIN PLATESDISPLAY	469
TOASTER	298-302
TOMATOES SLICER	135
TONG	31, 92, 103, 105-109, 454, 456-459, 475, 499
TONG. BUTCHER'S	459
TONG. CAKE	458
TONG. UTILITY	106-107, 457-458
TONGS, SERVING	456-458
TOP LINE	46-47
TRAY	84-87, 90, 222, 224, 351, 353, 355-356, 359, 366-375
TRAY (FAST-FOOD)	224
TRAY (GASTRONORM)	84
TRAY (NON-STICKALUMINIUM)	84, 87
TRAY (PASTRY)	86-87, 90, 375
TRAYS, FIBERGLASS	224
TRIANGLECAKEMOULD	170
TROLLEY (ALUMINIUM SERVING)	246
TROLLEY (DEFROSTWITHRAIL)	255
TROLLEY (DISASSEMBLED SERVING TROLLEY)	249
TROLLEY (DISASSEMBLED WITHRAIL)	251-254
TROLLEY (GUERIDON)	430
TROLLEY (INOX SERVING)	247-250
TROLLEY (PLASTIC)	246, 251-261
TROLLEY (RAIL)	251-256, 258-259
TROLLEY (STACKABLE)	252-253
TROLLEY (WOODEN)	428-431
TROLLEY FOR DISHWASER RACKS	259
TROLLEY FOR HEAVY LOADS	258
TROLLEY WITH WORKING TOP	258
TUBE	173-176
T-VERSION	230-235
UNIVERSAL STOPPER	502
VEGETABLE SCRAPER	140
VEGETABLE SIEVE	118
VERSATIL MACHINE	133
VERSATILE MANUAL PROCESSOR	136
VINYL RACK COVER	261
VIOLET COLLECTION	210
WAFFLE MAKER	296-297

ITEM	PAGE
WALL-MOUNTED COWKSCREW	502
WARMERS	329-330
WATER PITCHER	510-511
WEDGER	132
WHISK	153
WHITE WOOD SERVING TRAY	377
WINE BUCKETS	494-497
WINE COMPLEMENTS	502
WINE COOLER	495
WIRE SKIMMER	98
WOK (ST/STEEL)	66
WOK BLAC SERIES	73
WOK MULTIMETAL	71
WOK STEEL	75
WOK STEEL PRO	75
WOOD HANDLE UTENSILS	112
WOODEN TABLE. CUBIC	421

ARTICLE	PAGE
AIGUISEURÉLECTRIQUE.....	319
ANTIMICROBIEN	100-101
APLATISSEUR	121
APPAREILSETDE MAINTIEN EN TEMP.	329-330
APPAREILSMANUELS DE TRANSFORMATION DESALIMENTS.123-137	
ARAIGNÉE	98
ARDOISESPRÉSENTATION	472-473
ARMOIRECHAUD.....	335-336
ASSIETTES	223,348-354, 356-358, 360-361, 364, 371-372, 374
ASSIETTES,COULEUR.....	361
BAC GASTRONORMESANSBPA.....	206-207
BAIN-MARIE	42, 329, 334, 442
BALANCE	142
BAMBOU NATUREL & BOIS	474-475
BANDE À SILICONE	202
BARKEEP®	500
BARREINTERMÉDIAIRE	199, 400
BARREPORTE-BONS	122
BASSINE	151
BASSINEPÂTISSIÈRE	152
BATTERIEÀ COULEURS	49
BATTERIEDE CUISINE/ PRÉSENTATION.....	402-407
BATTERIEIDEA	50-51
BLACKFIRST.....	74
BLACKPRO.....	72-73
BLACKSERIES	56
BLENDERS	311-317
BOIS BLANVC, PLATEAU	377
BOÎTE À CONDIMENT.....	501
BOÎTEPPE	215
BOL .. 223, 348-349, 351, 354, 357-358, 360, 363-364, 366-367, 369-374	
BOL POUR SNACKS	348,356, 364, 386, 388, 485
BOLS DE SERVICEISOTHERMESÀDOUBLE PAROI	223, 444-447
BOLS NID D'ABEILLESÀPAROI INCLINÉE	447
BOUCHON À CHAMPAGNE	502
BOUCHON UNIVERSEL	502
BOUTEILLEDE BAR	500
BROCHETTE	29, 487
BROSSEMETALLIQUE.....	122
BRÛLERÉMAILLÉ	79
BUFFETCUBIC. CHARIOTBUFFET	428-431
BUFFETCUBIC. CUBESETTABLETTES.....	422-423
BUFFETCUBIC. MEUBLE PRÉSENTAIRE.....	421, 424-425
CAFETIÈRE	505-506
CANNETTEISOLANTE	508-509
CARAMÉLISER.....	159
CASSE-NOIX	459
CASSE-PATTES.....	459
CASSEROLEALUMINIUM.....	55
CASSEROLEBOMBÉE	42, 55
CASSEROLECOOL•LINE.....	49
CASSEROLEFORMEFRANÇAISE.....	41
CASSEROLEIDEA.....	51
CASSEROLEINOX-PRO	41-42
CASSEROLESDOSEUR	144
CAYENNE®	332-333
CAYENNE® RÉCHAUDSET APPAREILSDE REMISEEN TEMPÉRATURE.....	322-329
CENDRIER.....	389, 488
CENTRIFUGEUSES	319

ARTICLE	PAGE
CENTURY	53-55
CERCLE	168
CHAFERS	437-440
CHAFERSINTRIGUE	437
CHAFERS,ACCESSOIRESPOUR	437, 441
CHAFING DISH ECONOMIQUE	440
CHARIOT À CHARGESLOURDES	258
CHARIOT À DÉGIVRAGE.....	255
CHARIOT À GLAÇONS	261
CHARIOT À GLISSIÈRES.....	251-256, 258-259
CHARIOT À GLISSIÈRES,DÉMONTABLE	251-254
CHARIOT À GLISSIÈRES,EMBOÎTABLE	252-253
CHARIOT À PLASTIQUE	246, 251-261
CHARIOT AJUSTABLE.....	260
CHARIOT AVECPLAN DE TREVALL	258
CHARIOT DE DÉBARASSAGE	246, 250
CHARIOT DE SERVICE DÉMONTABLE	249
CHARIOT DE SERVICEENALUMINIUM	246
CHARIOT DOUBLE POUR PLATEAUXFAST-FOOD	256
CHARIOT EN BOIS.....	428-431
CHARIOT GUERIDON.....	430
CHARIOT POUR PANIERSÀ VAISSELLE	259
CHARIOT TRANSPORTBACGN	251-255
CHARIOTS DE SERVICEINOXYDABLE	247-250
CHINOISÀ GAZE	116
CLIP D'IDENTIFICATION	230, 236-237, 241-242
COCKTAIL	498-499
COCOTTE	56, 466
COCOTTEBLACKSERIES	56
COCOTTESFONTEALUMINIUM	466
COLLECTIVITÉS	222-225
CONTENEURPOUR SERVIETTES.....	489
COOL • LINE	48-49, 65
CORBEILLEPAIN	476-481
CORBEILLES POLYPROPYLENE	478-481
CORPSDE CHAUFFEPOUR CHAFING DISH	441
COUPEÀ GLACE.....	148
COUPE EN CUBES	133
COUPEFRITES.....	129
COUPETOMATES	135
COUPE-OEUF	136
COUPE-ONIONS	131
COUPE-SALADE	130
COUP-FRUITETLÉGUMES	131
COUSCOUSSIER.....	43
COUTEAU	451, 453, 456
COUTEAU/ ROULEAU (PIÈCEDE RECHNGE).....	136
COUTEAU À BEURRE	112
COUVER-ASSIETTESENPLASTIQUE	491
COUVERCLEBATTERIE	41, 47, 87
COUVERCLEGN.....	199, 203, 205, 207-208
COUVERCLEINOX-PRO.....	41
COUVERCLEPOLINORM®	203, 205, 207-208
COUVERCLEPOURCOUPELLEDESSERT.....	223
COUVERCLEPOURPANIER	238
COUVERCLESÀASSIETTE.....	491
COUVERCLESNGNTRANSPARENTS	395
COUVRE-ASSIETTESINOX.....	491
CREMIÈRE	504-506

ARTICLE	PAGE
CRÊPIÈRE	296
CROCHET	118
CUILLÈRE	98-99,102-103, 154, 373, 386, 451-456
CUILLÈREÀCOCKTAIL	499
CUILLÈREÀGLACE	102, 148
CUILLÈRESÀSERVIR.....	103, 451-452, 454-456
CUISEURÀRIZ.....	296
CUIT-PÂTES	44
CUIT-VAPEURINOX-PRO	44
DEMI-SPÉRIQUE.....	152
DISTRIBUTERÀJUS	443
DISTRIBUTEURÀJUS.CUBIC	417-418
DISTRIBUTEURÀLAIT.....	443
DISTRIBUTEURÀPRESSION.....	119-120
DISTRIBUTEURCONTRÔLEDE LA PARTIE	162
DISTRIBUTEURDE CÉRÉALES	443
DISTRIBUTEURDES SAQUETTES THÉ & SUCRE.CUBIC	421
DISTRIBUTEURSERVIETTES.CUBIC	421
DISTRIBUTEURS.....	162, 418, 443
DIVISEUR.....	132
DOSEURÀ PRESSER.....	102
DOUILLE.....	173-176
ECAILEUR.....	122
ECUMOIRE	97-98, 103, 451-454
EGOUTTOIRSPOURBACSGASTRONORME	199-200, 205, 207, 255
ELEGANCE.....	359
ENCASTRÉE.....	288, 292
ENTONNOIR.....	118, 161
ENTONNOIR DOSEUR.....	161
EPINGLEPORTE-TICKETS.....	487
ETAGÈRES.....	263-281
FAITOUT ALUMINIUM	54
FAITOUT COOL • LINE	48-49
FAITOUT IDEA	51
FAITOUT INOX-PRO	40
FAITOUT TOP LINE.....	47
FLAPIDENTIFICATION	229
FLAP-RACK®.....	228-229, 232-242
FONTAIN À CHOCOLAT	334
FOUET	153
FOURÀ BRAISE.....	24-25
FOURÀ MICRO-ONDES	293
FOURCHETTE	99, 103, 451-453, 456
FOURS.....	24-25, 293, 299
FRITEUSE.....	295
FUELPORCHAFINGDISH.....	441
GABARITS	406-407
GANT À FOUR.....	145
GANTS.....	145
GASTRONORMEPOUR CHARIOT DÉGIVRAGE.....	255
GASTRONORMINOXYDABLE.....	198-201, 203
GASTRONORME(MELAMINE).....	380-384
GASTRONORME(POLYCARBONATE).....	204-205
GASTRONORME(POLYPROPYLENE).....	208-209
GASTRONORMEAVECFOND THERMO-DIFFUSEUR.....	203, 347
GASTRONORMEVIOLET	210
GAUFFRIERS.....	296-297
GELLUBRIFIANTSANITAIRE.....	137
GLACES	148-149, 338-343

ARTICLE	PAGE
GOUTTIÈRE	170
GRILL	73-74
GRILL.....	304
GRILLPLAT AVECPOIGNÉES	89
GRILLEGN	88
GRILLEPÂTISSERIE.....	88, 162
HOUSSEJETABLES	258
HUILIÈRE	122
INOX-PRO	40-44
KITSPREPARÉSDEÉTEGÈRE	268-274
KITS.CUBIC	414-417
LAMPE CHAUFFANTE.....	331-333
LIDSAVER®.....	512-517
LOUCHE	96,103, 373, 451-455
MANDOLINES	137
MARMITE ALUMINIUM.....	54
MARMITE BUFFET	330
MARMITE COOL • LINE.....	48-49
MARMITE INOX-PRO.....	40, 44
MARMITE TOP LINE.....	47
MARMITE TRAITEURAVECROBINET	44
MARMITE TRAITEURIDEA.....	51
MARMITES DE REMISEEN TEMPÉRATURE	322-329
MARMITES DE REMISEEN TEMPÉRATURERÉTRO.....	324-325
MARQUEURS	461
MEDITERRANEAN.....	360
MELAMINE POUR PRÉSENTATION	346-389
MÉLAMINE SLIM.....	382-383
MÉLANGEURS.....	306-307
MÉLANGEURSDECOMPTOIR.....	306
MESUREÀ COCKTAIL	499
MINIATURE FONTE ÉMAILLÉE	464-465
MINIATURESMÉLAMINE.....	386-388
MINUTEUR DE CUISINE	142
MIRAGE®	291, 322-323
MIRAGE® 3D INDUCTION	322-323
MIRAGE® INDUCTION WARMER	291-292
MIRAMAR® BATTERIEDE CUISINE/ PRÉSENTATION	404-405
MIRAMAR® GABARITS.....	406-407
MIXEURS	308-310
MOULE À CAKE	163-165, 170, 179
MOULE À FLAN	170, 179
MOULE À FLAN ÉVASSÉ.....	485
MOULE À NID	98
MOULE À OEUF.....	121
MOULE À PIZZA.....	91
MOULE COEUR.....	169
MOULE HEXAGONE.....	169
MOULE LARME.....	169
MOULE OVALE.....	165, 169
MOULES“FLEXIPAN”	182-189
MOULESÀ SILICONE600 X 400	180-181
MOULESDE SILICONE	177-181
MOULES PÂTISSERIE.....	163-166, 168-170, 177-189
MOULIN À LÉGUMES	118
MOULINSÀ POIVRE.....	484
MOULINSÀ SEL	484
MULTIMÉTAL	42, 71
NUMÉRO DE TABLE	486

ARTICLE	PAGE
OICHETÀ EAU.....	510-511
OUVRE-BOÎTES	136
PALETTE	97,103,110-112, 154, 451-456
PALETTEÀ FISH.....	97, 111
PALETTEFAST-FOOD.....	111
PANIER FERMÉES	232-235
PANIER OUVERTS	236-237
PANIER POUR ASSITTES	240-242
PANIER POUR COUVERTS.....	238, 481
PANIER POUR PLATEAUX	242
PANIER POUR PLATEAUX ISOTHERMES.....	242
PANIER UNIVERSEL.....	238
PANIER, METALIQUE.....	432
PANNEAU INFORMATION.....	460
PARE-HALEIN MOBILES.....	392
PARE-HALEIN MOBILES EN ACRYLIQUE.....	392
PASSOIREÀ COCKTAIL.....	499
PASSOIREÀ POIGNÉES	117
PASSOIREÀ QUEUE	115-116
PELLEÀ ENFOURNER.....	92
PELLEÀ FARINE	152
PELLEÀ FRITES	109
PELLEÀ GÂTEAU	112, 451-452
PELLEÀ LEGUMES.....	140
PELLEPRÉSENTATION	376, 467
PETIT PANIER POUR LES COUVERTS	238
PICHET	507,508-511
PICHET POLYCARBONATE.....	511
PIED POUR BRÛLEUR	79
PINCE.....	31,92, 103, 105-109, 454, 456-459, 475, 499
PINCEÀ GÂTEAU.....	458
PINCEÀ VIANDE.....	459
PINCE BUFFET	106-107, 457-458
PINCE DE SERVICE	456-458
PINCEAU	156
PINCES POUR PRÉSENTATION.....	105
PIQUE SUPPORT PRÉSENTATION.CUBIC	419
PLANCHEÀ DÉCOUPER.....	138-140
PLANCHEÀ DÉCOUPER VIOLET	140
PLAQUE "DÉFENSE DÉFUMER".....	486
PLAQUE "RESERVÉ"	486
PLAQUEÀ PÂTISSERIE.....	86-87, 90, 375
PLAQUEÀ PIZZA	91
PLAQUEÀ RÔTIR.....	82-83, 89
PLAQUE ALUMINIUM ANTI-ADHÉSIF.....	84, 87
PLAQUE CHAUFFANTE	334
PLAQUE GASTRONORME.....	84
PLAQUE INTERMÉDIAIRE INCLINÉE.....	434
PLAQUE RÉFRIGÉRANTE	442
PLAQUE INDUCTION.....	284-291
PLAT À PAELLA ACIERÉ MAILLÉ	78
PLAT À PAELLA ALUMINIUM.....	70
PLAT À PAELLA EN TÔLE ACIER.....	78
PLAT À PAELLA INOX-PRO	40
PLAT À PAELLA TOP LINE.....	47
PLAT OVALE.....	349,352-353, 359, 369, 374, 448, 465
PLATEAU	84-87,90, 222, 224, 351, 353, 355-356, 359, 366-375
PLATEAU.....	503
PLATEAU DE SERVICE ANTI-DÉRRAPANT	381, 503

ARTICLE	PAGE
PLATEAU FAST-FOOD.....	224
PLATEAU FORME OVALE	487
PLATEAU ISOTHERMIC	222
PLATEAU MARBRES NOIR	378-379
PLATEAU PRÉSENTATION.....	375
PLATEAU PRÉSENTATION.CUBIC	420
PLATEAU SELF-SERVICE ACIER INOX.....	224
PLATEAUX EN FIBRE DE VERRE.....	224
PLATEAUX INOX PRÉSENTATION	469
POCHES PÂTISSIÈRES.....	171-172
POÊLE "LYONNAISE"	77
POÊLE À BLINIS	70
POÊLE À CRÊPES.....	70, 73-74, 77
POÊLE ACIER INOXYDABLE	64-66
POÊLE ALUMINIUM	67-70
POÊLE ALUMINIUM FONTÉ.....	72-73
POÊLE BLACK SERIES.....	72-72
POÊLE COOL • LINE	65
POÊLE HAUTE AVEC ANSES.....	78
POÊLE IDEA.....	66
POÊLE MULTIMÉTAL.....	71
POÊLE STEEL PRO 1921	75
POÊLES.....	60-77
POLYCARBONATE DOUILLE.....	176
PORTE-BROCHETTES.....	29, 487
PORTE-CARTES	490
PORTE-MENU.....	490
POT À INFUSIONS	507
POT MESUREUR	144
POTEAU.....	460
PRÉSENTOIR.....	432-435
PRÉSENTOIR 3 NIVEAUX.CUBIC	418
PRÉSENTOIR BACS GASTRONORME	375
PRÉSENTOIR BOL SMÉLAMINE.CUBIC.....	423
PRÉSENTOIR DÉTARTES	160
PRÉSENTOIR GN BAMBOU	433
PRÉSENTOIR GRANITE-ARDOISE	379
PRESSE CITRON.....	499
PROCESSEUR VERSATILE ET MANUEL	136
PROTECTRICE EN VINYLE	261
RACLETTE	111-112, 122, 157
RAMASSE-COUVERTS	225
RAMASSE-COUVERTS POUR CHARIOT SERVICE.....	250
RAMASSE-MIETTES	488
RAMEQUIN	348,356, 364, 386, 388, 485
RÂPE.....	113-114
RECEPTALBE À DÉCHETS.....	488
RÉCHAUD.....	337
RÉCIPIENT À GLACE	149
RECTANGLE POUR PLAQUES INOX.....	86
REFRAÎCHISSEUR.....	495
REFRAÎCHISSEUR BOUTEILLES.CUBIC.....	421
REFRAÎCHISSEUR ISOTHERME	497
ROBOT MULTIFUNCTION	306-307
ROULEAU	155-156
ROULETTE À PÂTES.....	155, 167
ROULETTE À PIZZA.....	111
RUBAN PÂTISSIER.....	169
SACS À DOS DE LIVRAISON	220-221

ARTICLE	PAGE
SACSÀ PIZZAS	216-217
SACSDE TRAITEUR	218-219
SALADIER	449
SAUCIÈRE	485
SAUPOUDREUSES	120
SAUTEUSEALUMINIUM	55
SAUTEUSEINOX-PRO	42
SEAUÀ CHAMPAGNE	494-496
SEAUÀ CHAMPAGNE EN PLASTIQUE	494-495
SEAUÀ CHAMPAGNE, COMPLEMENTS	502
SEAUÀ GLAÇONS	497
SEAUAVECBASE	144
SEAUXÀ VIN	494-497
SÉPARATEURDE PORTIONS	157
SETSDE TABLE	482-483
SHAKER	498
SOLUTIONSDE DISTRIBUTION	512-517
SOUPIÈRE	449
SPATULEGÉANTE	122
SPOODLE®	100-101
STATIONS POUR BUFFET	333
STEELPRO 1921. FONTE ULTRALÉGER INDUCTION	75
STONE	358
STOP GOUTTES	502
SUCRIER	505
SUPERPAN® SUPERSHAPES	398-400
SUPPORTÀ PIQUES.CUBIC	419
SUPPORTDE TABLE POU SEAUX	497
SUPPORTDOUBLE PORTE-COUVERTSGN	225
SUPPORTNUMÉRO	486
SUPPORTPOURBACSGN	257, 431
SUPPORTPOURBACSGN	202, 385
SUPPORTPOUR COUVERCLES GN	202
SUPPORTPOUR ENTONNOIR OU CHINOIS	116
SUPPORTPOUR GRANDS PLATEAUX	487
SUPPORTPOUR PLANCHESÀ DÉCOUPER	202
SUPPORTPOUR PLATEAUÀ FRUITSDE MER	487
SUPPORTPOUR POCHEPÂTISSIER	172
SUPPORTRAMASSE-COUVERTS	225, 257, 420, 431
TABLEÀ DÉCOUPER	140
TABLE EN BOIS.CUBIC	421
TABLEAUX	461
TAMIS	160
TAPIS	145
TAPISANTIDÉRAPANT	503
TAPISDE BAR	500
TASSE	223, 373
TERRACOTA	356-357
THÉIÈRE	505-507
THÉIÈREAVECFILTRE	507
THERMOMÈTRE	142-143
TIRE-BOUCHONS	502
TIRE-BOUCHONS MUR	502
TOASTEUR	298-302
TOILEDE CUISSON	92
TOP LINE	46-47
TORCHEÀ CARAMÉLISER	159
TORCHON EN SILICONE	145
TRANCHESETCUBES	127-128

ARTICLE	PAGE
TRANCHEURELÉCTRIQUE	307
TURBINEÀ GLACE	340-342
T-VERSION	230-235
USTENSILES MANCHE EN BOIS	112
USTENSILSDE SERVICE	451-459
VERRE	223, 360
VERSATIL MACHINE	133
VERSEUSEÀ POMPE	508-509
VIDE/ COUPE POMMES	136
VIOLET COLLECTION	210
VITRINESÀ PÂTISSERIES	394-395
VITRINESPRÉSENTATION	394-395
WOK ACIER	75
WOK BLACK SERIES	73
WOK INOX	66
WOK MULTIMÉTAL	71
WOK STEELPRO	75

ARTIKEL	SEITE
ABRÄUMWAGEN.....	246, 250
ABSPERRUNG	460
ADAPTERSCHIENE.....	199, 400
ALUMINIUMGUSSPFANNE	72-73
ALUMINIUMSAUTEUSE	55
ALUMINIUMTOPF	55
ANGEWINKELTEBIENENSTOCK-SCHÜSSELN	447
ANTIHAFTBESCHICHTETESALUMINIUMBLECH	84, 87
ANTIMIKROBIOTIKUM.....	100-101
ANTITROPFRING	502
ANZEIGETAFELN	472-473
APFELAUSSTECHER.....	136
ARBEITSFLÄCHEN-MIXER	306
ASCHENBECHER	389, 488
AUSFSTRICHMESSER.....	112
AUSGABELÖSUNGEN.....	512-517
AUSLAGEVETRINE	394-395
AUSSTECHFORMEN	155, 167
AUSSTELLERGASTRONORM	375
BACKWARENVITRINEN	394-395
BARKEEP®	500
BARFLASCHE	500
BARMATTEN	500
BEHÄLTERFÜR SERVICEWAGEN	250
BESTECKKASTEN	225
BESTECKKASTEN.....	225, 257, 420, 431
BESTECKKÖRBCHEN.....	238
BESTECKSPÜLKORB.....	238, 481
BLACKFIRST.....	74
BLACKPRO.....	72-73
BLACKSERIES	56
BLINISPFANNE	70
BRÄTER	82-83, 89
BRATPFANNECOOL • LINE.....	65
BRENNSTOFFFÜRCHAFINGDISH	441
BROTKORB	476-481
BUFFETCUBIC.BUFFETWAGEN	428-431
BUFFETCUBIC.KÜBEL UND REGALE	422-423
BUFFETCUBIC.VITRINE	421, 424-425
BUFFETFLASCHENKÜHLER.CUBIC.....	421
BÜFFETSTATIONEN.....	333
BUFFETTISCHCHEN	421
BUFFETUTENSILIEN	451-459
BUFFETZANGE	106-107, 457-458
CATERINGTASCHEN	218-219
CAYENNE®	332-333
CAYENNE® SPEISENWÄRMERUND RETHERMALISIERER.....	322-329
CENTURY	53-55
CHAMPAGNERKÜHLER.....	502
COCKTAIL	498-499
COCKTAIL-LÖFFEL.....	499
COCKTAIL-SIEB.....	499
COOL • LINE	48-49, 65
COUSCOUSTOPF	43
CREPE-EISEN	296
CREPEPFANNE.....	70, 73-74, 77
DAMPFGARERINOX-PRO	44
DECKELFRÜHSTÜCKSTASSE	223
DECKELFÜRKOCHGESCHIRR	41, 47, 87

ARTIKEL	SEITE
DECKELINOX-PRO	41
DECKELPOLINORM®.....	203, 205, 207-208
DECKELGN.....	199, 203, 205, 207-208
DIGITALE KÜCHENUHR.....	142
DOPPELTERFAST-FOOD TABLET-TROLLEY.....	256
DOPPELWANDIG ISOLIERTESERVIERERSCHÜSSELN.....	223, 444-447
DOSIERUNGSTRICHTER	161
DOSSIERKASSEROLLEN	144
DREIECKIGEFORM.....	170
DREIFUSSSTÄNDERFÜRGASBRENNER	79
DRUCKDISPENSER.....	119-120
EDELSTAHL-TELLERHAUBEN	491
EIERSCHNEIDER.....	136
EIFORM	121
EIMERMIT FUSS	144
EINBAU	288, 292
EINSETZSCHABLONEN	406-407
EINSTELLBARERTELLERWAGEN	260
EINWEG-HÜLLENAUSPOLYÄTHYLEN.....	258
EISCREMEBECHER.....	148
EISCREMESCHALEN	149
EISDIELE	148-149, 338-343
EISKÜBEL	497
EISMASCHINE	340-342
EISPORTIONIERER.....	102
EISPORTIONIERER.....	102, 148
EISWAGEN	261
ELEGANCE	359
ELEKTRISCHERAUFSCHNITTMASCHINE.....	307
ELEKTRISCHERBRENNER	159
ELEKTRISCHERTOPF.....	330
ELEKTRISCHESELEMENTFÜRCAHFINGDISH	441
EMAILLIERTEGASPAELLAPFANNE.....	79
EMAILLIERTEPAELLAPFANNEAUSSTAHL	78
EPP-BOX.....	215
FAST-FOOD-SCHAUFEL	111
FAST-FOOD-TABLETT.....	224
FISCHENTSCHUPPER.....	122
FISCHWENDER.....	97, 111
FLAPIDENTIFIKATION.....	229
FLAP-RACK®.....	228-229, 232-242
FLEISCHSTAMPFER.....	121
FORMEN"FLIXPLAN"	182-189
FRANZÖSISCHERKOCHTOPFINOX-PRO.....	41
FRITEUSE.....	295
FRITTENHEBER.....	109
FRITTIERSCHAUFEL	98
GABEL	99, 103, 451-453, 456
GASTRONORMBEHÄLTEROHNE BPA	206-207
GASTRONORMDIFFUSIONSBODEN	203, 347
GASTRONORMMELAMIN	380-384
GASTRONORMPOLYKARBONAT	204-205
GASTRONORMPOLYPROPYLEN	208-209
GASTRONORMROSTFREI.....	198-201, 203
GASTRONORMVIOLET	210
GASTRONORMTABLETT	84
GEBÄCKZANGE	458
GELOCHTEBÖDENGASTRONORM.....	199-200, 205, 207, 255
GEMÜSEHACKER	140

ARTIKEL	SEITE
GEMÜSEHOBEL.....	137
GEMÜSESIEB	118
GEWINKELTEADAPTERPLATTE	434
GEWÜRZKISTE	501
GEWÜRZSTÄNDER	120
GLAS	223, 360
GLASFASERTABLETTS.....	224
GN BAMBUSBOX	433
GN TRANSPORTWAGEN.....	251-255
GRANIT-SCHIEFERPRÄSENTIERPLATTE	379
GRILL	304
GRILL	73-74
GRILLKORB,SCHWARZER	432
GRILLÖFEN	24-25
GRILLPLATTEMIT GRIFFENALUMINIUM	89
HAKEN	118
HALBKUGELFORM.....	152
HALTERFÜRBESTECKKASTENGN	225
HALTERFÜRGN DECKEL.....	202
HALTERFÜRGRÖSSEPLATTEN	487
HALTERFÜRSCHNEIDEBRETTER.....	202
HALTERFÜRSPRITZBEUTEL.....	172
HERDPLATTE	334
HERZFORM.....	169
IDEA KASSEROLLE	51
IDEA KOCHBEDARF	50-51
IDEA STIELKASSEROLLE	51
IDEA TOPF	51
INDIVIDUELLEPLATZMATTEN	482-483
INDUKTIONSKOCHFELDER.....	284-291
INDUSTRIELLERDOSENÖFFNER	136
INFORMATIONSTAFEL	460
INOX-PRO	40-44
ISOTHERMISCHERKÜHLER.....	497
ISOTHERMISCHESTABLETT	222
KAFFEEKANNE	505-506
KANNE	507,508-511
KARAFFEAUSPOLYCARBONAT.....	511
KARTENHALTER.....	490
KASSEROLLE	56, 466
KASSEROLLEALUMINIUM	54
KASSEROLLEBLACKSERIES.....	56
KASSEROLLECOOL+LINE	48-49
KASSEROLLECOOL+LINE	49
KASSEROLLEINOX-PRO	40
KASSEROLLETOPLINE	47
KOCHGESCHIRRFARBIG.....	49
KOCHTOPFINOX-PRO.....	41-42
KOLLEKTIVITÄT	222-225
KOMPLETTEREGALSETS	268-274
KONISCHE, TIEFEPLATTE	152
KONISCHERKOCHTOPF	42, 55
KORKENZIEHER.....	502
KORKENZIEHERWANDMONTAGE.....	502
KREIDEMARKER	461
KRÜMMELCHAUFEL.....	488
KÜCHENBACKFORM	163-165, 170, 179
KÜCHENBRENNER.....	159
KÜCHENMASCHINE.....	306-307

ARTIKEL	SEITE
KÜCHENMASCHINE.....	133
KÜHLPLATTE	442
LEBENSMITTEL-LIEFERRUCKSACK.....	220-221
LIDSAVER®.....	512-517
LÖFFEL.....	98-99,102-103, 154, 373, 386, 451-456
LÖFFEL.....	103,451-452, 454-456
LYONERPFANNE	77
MANUELLE KÜCHENMASCHINEN.....	123-137
MATTEN	145
MEDITERRANEAN.....	360
MEDIZINISCHESGLEITGEL.....	137
MEERESFRÜCHTEZANGE	459
MELAMIN MINIATUREN.....	386-388
MELAMIN PRÄSENTATION	346-389
MELAMIN PRÄSENTIERSCHALEN.....	423
MELMIN SLIM.....	382-383
MENÜHALTER	490
MESSBECHER	499
MESSBECHER	144
MESSER.....	451,453, 456
MESSER/RAD(ERSATZTEIL).....	136
MESSERSCHÄRFER.....	319
METALLBÜRSTE	122
MIKROWELLE	293
MILCHDISPENSER.....	443
MILCHKÄNNCHEN	504-506
MINIATUREN GUSSEISEN.....	464-465
MINISAUSALUMINIOM GUSS.....	466
MIRAGE®	291,322-323
MIRAGE® 3D INDUCTION	322-323
MIRAGE® INDUCTION WARMER	291-292
MIRAMAR® EINSETZSCHABLONEN.....	406-407
MIRAMAR® PRÄSENTATIONS-KOCHGESCHIRR	404-405
MIXER	311-317
MIXERS	306-307
MOBILE ACRYL-ATEMSCHUTZPLATTEN	392
MOBILE ATEMSCHUTZPLATTEN.....	392
MULTIFUNKTIONSREIBE	136
MULTIMETAL	42, 71
NAMENSSCHILDERMITCLIP	230, 236-237, 241-242
NATURBAMBUS& HOLZ.....	474-475
NOTIZLEISTE	122
NUDELSIEB	44
NUSSKNACKER.....	459
OBSTSCHNEIDER.....	131
ÖFEN	24-25, 293, 299
ÖKONOMISCHERCHAFINGDISH.....	440
ÖLKANNE.....	122
OVALEFORM	165, 169
OVALEPLATTE	487
OVALEPLATTE.....	349, 352-353, 359, 369, 374, 448, 465
PAELLAPFANNEALUMINIUM.....	70
PAELLAPFANNEINOX-PRO.....	40
PAELLAPFANNETOPLINE	47
PATISSERIEFORMEN.....	163-166,168-170, 177-189
PATISSERIEROST.....	88, 162
PATISSERIETABLETT.....	86-87, 90, 375
PFANNEALUMINIUM.....	67-70
PFANNE BLACKSERIES	72-72

ARTIKEL	SEITE
PFANNE EDELSTAHL	64-66
PFANNE IDEA	66
PFANNE MULTIMETAL	71
PFANNE STEELPRO1921	75
PFANNEN	60-77
PFANNENWENDER	97, 103, 110-112, 154, 451-456
PFEFFERMÜHLE	484
PINSEL	156
PIZZAFORM	91
PIZZAMESSER	111
PIZZAPLATTE	91
PIZZASCHAUFEL	92
PIZZATASCHEN	216-217
PLASTIK-SEKTKÜHLER	494-495
POLYPROPYLENKÖRBE	478-481
POMMES FRITES-SCHNEIDER	129
PORTIONIERER	152
PORTIONSKONTROLLSPENDER	162
PRÄSENTATIONS-KOCHGESCHIRR	402-407
PRÄSENTATIONSSCHALE	375
PRÄSENTATIONSSTÄNDER	432-435
PRÄSENTATIONSTABLETT.CUBIC	420
PRÄSENTATIONSTABLETTES	469
PRÄSENTIERHALTER FÜR SPIESSCHEN, VIERECKIG	419
PRÄZISIONSPINZETTE	105
PUDDINGFORM	170, 179
PVC-BAND FÜR MOUSSE	169
RAHMEN FÜR BACKBLECHE	86
RECHAUDS	437-440
RECHAUDSINTRIGUE™	437
RECHAUD-ZUBEHÖR	437, 441
RECHTECKIGEM ARMOR-PRÄSENTATIONSPLATTE	378-379
REGALE	263-281
REIBE	113-114
REISKOCHER	296
REHERMALISIERER	322-329
RETROREHERMALISIERER	324-325
RING	168
ROSTGN	88
RÜHRBESEN	153
RÜHRQUIRL	122
RÜHRSCHÜSSEL	151
RUTSCHFESTEMATTE	503
SAFTDISPENSER	443
SAFTPRESSE	319
SAFTSPENDER.CUBIC	417-418
SALATSCHNEIDER	130
SALATSCHÜSSEL	449
SALZMÜHLE	484
SAUCIEREGEWELLTERRAND	485
SAUTEUSE INOX-PRO	42
SCHABER	111-112, 122, 157
SCHALE	223, 348-349, 351, 354, 357-358, 360, 363-364, 366-367, 369-374
SCHAUMLÖFFEL	97-98, 103, 451-454
SCHILD "RAUCHEN VERBOTEN"	486
SCHILD "RESERVIERT"	486
SCHNEIDEBRETT	138-140
SCHNEIDEBRETT VIOLET	140
SCHNEIDETISCH	140

ARTIKEL	SEITE
SCHOKOLADENBRUNNEN	334
SCHÖPFLÖFFEL	96, 103, 373, 451-455
SCHUTZHANDSCHUHE	145
SCHUTZHÜLLE VINYL	261
SECHSECKIGE FORM	169
SEKTKORKEN	502
SEKTKÜHLER	494-496
SELBSTBEDIENUNGSTABLETTE EDELSTAHL	224
SERVICETABLETT ANTIRUTSCHBERSCHICHTUNG	381, 503
SERVIERPLATTE	376, 467
SERVIERTABLETT	503
SERVIERWAGEN (ALUMINIUM)	246
SERVIERWAGEN (DEMONTIERBAR)	249
SERVIERWAGEN (INOX)	247-250
SERVIERZANGE	456-458
SERVIETTENHALTER	489
SERVIETTENSPENDER	421
SETS.CUBIC	414-417
SHAKER	498
SIEB	160
SIEB	115-116
SIEB	117
SILIKON-BAND	202
SILIKONFORMEN	177-181
SILIKONFORMEN 600 X 400	180-181
SILIKONTUCH	145
SILIKONTUCH	92
SNACKSCHÄLCHEN	348, 356, 364, 386, 388, 485
SOSSEN-UND SNACKHALTER	485
SOSSENSCHALE	348, 356, 364, 386, 388, 485
SPEISEWÄRMERIMVERGLEICH	329-330
SPENDER	162, 418, 443
SPIESS	29, 487
SPIESSCHENHALTER, VIERECKIG	419
SPIESSHALTER	29, 487
SPITZSIEB	116
SPOODLE®	100-101
SPRITZBEUTEL	171-172
SPÜLKORB (GESCHLOSSENES SYSTEM)	236-237
SPÜLKORB (GROSSETABLETTES)	242
SPÜLKORB (ISOTHERMISCHETABLETTES)	242
SPÜLKORB (OFFENES SYSTEM)	232-235
SPÜLKORB (TELLER)	240-242
SPÜLKORBDECKEL	238
STABMIXER	308-310
STAHLWOK	75
STÄNDERDREIEBENEN.CUBIC	418
STÄNDER FÜR GN BEHÄLTER	202, 385
STÄNDER FÜR MEERESFRÜCHTEPLATTE	487
STÄNDER FÜR SEKTKÜHLER	497
STÄNDER FÜR SPITZSIEB ODER TRICHTER	116
STEELPRO 1921. GUSSEISEN ULTRALEICHTINDUKTION	75
STONE	358
SUPERPAN® SUPERSHAPES	398-400
SUPPENSCHÜSSEL	449
TABLETT	84-87, 90, 222, 224, 351, 353, 355-356, 359, 366-375
TAFELN	461
TASSE	223, 373
TEE-UND ZUCKERBEUTELHALTER	421

ARTIKEL	SEITE
TEEKANNE	507
TEEKANNE	505-507
TEEKANNEMIT FILTER.....	507
TEIGROLLE	155-156
TELLER.....	223, 348-354, 356-358, 360-361, 364, 371-372, 374
TELLER,FARBE	361
TELLERHAUBEN.....	491
TELLERHAUBEN,KUNSTSTOFF	491
TELLERWÄRMER	337
TERRACOTA	356-357
THERMOMETER	142-143
THERMOSKANNE	508-509
THERMOTSKANEMIT DOSIERER	508-509
TIEFE,EMALLIERTEPFANNEMIT GRIFFEN.....	78
TISCHABFALLEIMER	488
TISCHNUMMERHALTER	486
TISCHNUMMERN	486
TISCHWÜRFELSCHNEIDERUND-HOBEL.....	127-128
TOASTER.....	298-302
TOMATENSCHNEIDER.....	135
TOP LINE.....	46-47
TOPFALUMINIUM.....	54
TOPFCOOL • LINE.....	48-49
TOPFINOX-PRO	40, 44
TOPFMIT HAHN	44
TOPFTOP LINE.....	47
TOPFHANDSCHUH	145
TORTENHEBER	112,451-452
TORTENSCHNEIDER	157
TORTENSTÄNDER.....	160
TRÄNENFORM	169
TRANSPARENTEGNPRÄSENTATIONDECKEL	395
TRANSPORTWAGEFÜRBESTECKBEHÄLTER	257, 431
TRICHTER	118, 161
TROLLEY(GUERIDON).....	430
TÜLLE	173-176
TÜLLEPOLYCARBONAT	176
T-VERSION	230-235
UNIVERSALSPÜLKORB	238
UNIVERSELLERKORKEN.....	502
UTENSILIENMIT HOLZGRIFF	112
VALENZIANISCHEPAELLAPFANNE	78
VIOLET COLLECTION.....	210
VOGELNESTFORM	98
WAAGE.....	142
WAFFELEISEN.....	296-297
WAGEN (AUFTAUEN)	255
WAGEN (EINSCHÜBEDEMONTIERBAR).....	251-254
WAGEN (EINSCHÜBE)	251-256, 258-259
WAGEN (HOLZ).....	428-431
WAGEN (KUNSTSTOFF).....	246, 251-261
WAGEN (STAPELBAR).....	252-253
WAGEN AUFTAUEN	255
WAGEN FÜRSCHWERELASTEN.....	258
WAGEN FÜRSPÜLKORBE	259
WAGEN MIT ARBEITSFLÄCHE.....	258
WÄRMELAMPEN.....	331-333
WARMHALTESCHRANK.....	335-336
WASSERBAD	42,329, 334, 442

ARTIKEL	SEITE
WASSERKRUG.....	510-511
WEDGERSCHNEIDER.....	132
WEIBEHOLZPRÄSENTATIONSTABLETT.....	377
WEINKÜHLER	494-497
WEINKÜHLER	495
WOK BLACKSERIES.....	73
WOK INOX	66
WOK MULTIMETAL	71
WOK STEELPRO.....	75
WÜRFELSCHNEIDER.....	133
WURSTZANGE	459
ZANGE	31,92, 103, 105-109, 454, 456-459, 475, 499
ZEREALIEN-DOPPELBEHÄLTER.....	443
ZETTELSPIESSER.....	487
ZITRONENPRESSE.....	499
ZUCKERDOSE.....	505
ZWIEBELSCHNEIDER	131

ARTIGO	PÁGINA
ABRE-LATASINDUSTRIAL.....	136
AÇUCAREIRO.....	505
AFIADORDE FACAS.....	319
ALMOTOLIA.....	122
ANELANTI-GOTEJAMENTO.....	502
ANTIMICROBIANO.....	100-101
APANHADOR DE MIGALHAS.....	488
APRESENTADORCUBASGN.....	202, 385
APRESENTADORTIGELASME LAMINA. CUBIC.....	423
AQUECEDORDE PRATOS.....	337
AQUECEDORINDUÇÃO MIRAGE.....	291-292
AQUECEDORES.....	329-330
ARANHA.....	98
ARDÓSIAS.....	461
ARDÓSIASAPRESENTAÇÃO.....	472-473
ARGOLADE GUARDANAPO.....	489
ARGOLADE GUARDANAPO. CUBIC.....	421
ARMÁRIO QUENTE.....	335-336
ARO.....	168
ASSADEIRA.....	82-83, 89
ASSADORGRILL.....	73-74
BALANÇA.....	142
BALDECHAMPANHE.....	494-496
BALDECOM BASE.....	144
BALDEDE GELODE PLÁSTICO.....	494-495
BALDEGELO.....	497
BAMBU NATURAL & MADEIRA.....	474-475
BANDEJA.....	84-87, 90, 222, 224, 351, 353, 355-356, 359, 366-375
BANDEJAALUMÍNIO ANTI-ADERENTE.....	84, 87
BANDEJAAPRESENTAÇÃO.....	375
BANDEJAEMPREGADODE BAR.....	503
BANDEJAFAST-FOOD.....	224
BANDEJAGASTRONORM.....	84
BANDEJAISOTÉRMICA.....	222
BANDEJAOVAL.....	487
BANDEJAPASTELARIA.....	86-87, 90, 375
BANDEJAPORTA-TALHERES.....	225
BANDEJASELF-SERVICEAÇOINOX.....	224
BANDEJASANTIDESLIZANTES.....	381, 503
BANDEJASFIBRADE VIDRO.....	224
BANDEJAS. CUBIC.....	420
BANDOLINS.....	137
BANHO-MARIA.....	42, 329, 334, 442
BARKEEP®.....	500
BARRADE NOTAS.....	122
BASEPIZA.....	91
BATEDEIRASDECOPO.....	311-317
BATEDOR.....	153
BATEDORADE MESA.....	306
BATERIAAPRESENTAÇÃO.....	402-407
BATERIACOR.....	49
BATERIAIDEA.....	50-51
BLACKFIRST.....	74
BLACKPRO.....	72-73
BLACKSERIES.....	56
BOLSA PROTECTORADE VINIL.....	261
BOLSASREJEITÁVEISPOLIETILENODISTRIBUIDOR.....	258
BOQUILHA.....	173-176
BOQUILHA POLICARBONATO.....	176

ARTIGO	PÁGINA
BRAÇOSTRITURADORES.....	308-310
BUFETECUBIC. BALDESE ESTANTES.....	422-423
BUFETECUBIC. CARROBUFETE.....	428-431
BUFETECUBIC. MÓVEL EXPOSITOR.....	421, 424-425
CAÇAROLAALUMÍNIO.....	54
CAÇAROLACOOOL • LINE.....	48-49
CAÇAROLAIDEA.....	51
CAÇAROLAINOX-PRO.....	40
CAÇAROLATOPLINE.....	47
CAÇOILAALUMÍNIO FUNDIÇÃO.....	56, 466
CAÇOILABLACKSERIES.....	56
CAFETEIRA.....	505-506
CAIXACONDIMENTOS.....	501
CAIXAGN BAMBU.....	433
CALDEIRO.....	151
CARROCOM GUIAS.....	251-256, 258-259
CARROCOM GUIAS, DESMONTÁVEL.....	251-254
CARROCOM GUIAS, ENCASTRÁVEL.....	252-253
CARROCOM SUPERFÍCIEDETRABALHO.....	258
CARRODE MADEIRA.....	428-431
CARRODE PLÁSTICO.....	246, 251-261
CARRODE SERVIÇODESMONTÁVEL.....	249
CARRODE SERVIÇOEMALUMÍNIO.....	246
CARRODE SERVIÇOINOXIDÁVEL.....	247-250
CARRODESCONGELAÇÃO.....	255
CARRODESEMBARAÇO.....	246, 250
CARRODUPLO PARA BANDEJASFAST-FOOD.....	256
CARROGASTRONORMDESCONGELAÇÃO.....	255
CARROGELO.....	261
CARROGUERIDON.....	430
CARROPARA CARGASPESADAS.....	258
CARROPARA CESTOS.....	259
CARROPARA PRATOSAJUSTÁVEL.....	260
CARROPORTA-CUBASGASTRONORM.....	251-255
CARROPORTA-TALHERES.....	257, 431
CATERINGBAGS.....	218-219
CAYENNE®.....	332-333
CENTURY.....	53-55
CESTAGRADEADA.....	432
CESTAPÃO.....	476-481
CESTINHOPARA TALHERES.....	238
CESTODEPAPÉISMESA.....	488
CESTOGRANDESBANDEJAS.....	242
CESTOPARA BANDEJASISOTÉRMICAS.....	242
CESTOPARATALHERES.....	238, 481
CESTOUNIVERSAL.....	238
CESTOSABERTOS.....	232-235
CESTOSFECHADOS.....	236-237
CESTOSPARAPRATOS.....	240-242
CESTOSPOLIPROPILENO.....	478-481
CHAFINGDISH.....	437-440
CHAFINGDISHSECONÓMICOS.....	440
CHAFINGDISHESINTRIGUE.....	437
CHAFING, ACESSÓRIOS.....	437, 441
CHALEIRA.....	505-507
CHALEIRACOM FILTRO.....	507
CHAMPANHEIRA.....	494-497
CHAMPANHEIRA, COMPLEMENTOS.....	502
CHARCOALOVEN.....	24-25

ARTIGO	PÁGINA
CHÁVENA	223, 373
CINZEIRO	389, 488
COADOR	115-116
COADOR CHINÊS	116
COADOR DE LÍQUIDOS	499
COADOR DE MASSA	44
COCKTAIL	498-499
COLECTIVIDADES	222-225
COLHER	98-99, 102-103, 154, 373, 386, 451-456
COLHER BATEDEIRA	499
COLHER PARA UNTAR	112
COLHER SERVIÇO	103, 451-452, 454-456
CONCHA	96, 103, 373, 451-455
CONJUNTO DE TEMPEROS	120
CONJUNTOS DE ESTANTES COMPLETOS	268-274
CONJUNTOS CUBIC	414-417
COOL • LINE	48-49, 65
COPO	223, 360
COQUETELEIRA	498
CORTADOR DE ALFACE	130
CORTADOR DE BATATAS FRITAS	129
CORTADOR DE CEBOLAS	131
CORTADOR DE OVOS	136
CORTADOREM CUBOS	133
CORTADOR SECCIONADOR	132
CORTADOR TOMATES	135
CORTADOR/DESCAROÇADOR MAÇÃS	136
CORTADORA DE FIAMBRE SELÉCTRICA	307
CORTADORA DE FRUTAS E VERDURAS	131
CORTADOR-FIADOR	127-128
CORTA-MASSAS	155, 167
CRIVO	160
CUBA GASTRONORM SEMBPA	206-207
CUBAS GELATARIA	149
CUSCUZEIRA	43
DELIVERY BACKPACKS	220-221
DISTRIBUIDOR COM CONTROLO DE PORÇÕES	162
DISTRIBUIDOR DE CEREAIS	443
DISTRIBUIDOR DE SUMOS	443
DISTRIBUIDOR LEITE	443
DISTRIBUIDOR SACOS CHÁ E AÇÚCAR CUBIC	421
DISTRIBUIDOR SOB PRESSÃO	119-120
DISTRIBUIDOR SUMOS CUBIC	417-418
DISTRIBUIDORES	162, 418, 443
DOSEADOR LICOR	499
ELEGANCE	359
ELEMENTO ELÉCTRICO CHAFING DISH	441
EPPBOX	215
ESCAMADOR	122
ESCORREDOR	117
ESCOVA METÁLICA	122
ESCUMA DE MADEIRA	97-98, 103, 451-454
ESMAGA-CARNES	121
ESPÁTULA	97, 103, 110-112, 154, 451-456
ESPETO PARA NOTAS	487
ESPETOS SUPORTE APRESENTAÇÃO CUBIC	419
ESPREME-LIMÕES	499
ESTAÇÃO BUFFET TRINTANCHE	333
ESTANTES	263-281

ARTIGO	PÁGINA
EXPOSITORES DE TORTAS	160
EXPOSITOR DOÇARIA	394-395
EXPOSITOR GASTRONORM	375
EXPOSITOR TRÊSNÍVEIS CUBIC	418
EXPOSITORES	432-435
FACA	451, 453, 456
FERVEDOR DE ARROZ	296
FITA DE SELAGEM SILICONE	202
FITA PVC PARA MOUSSE	169
FLAP IDENTIFICAÇÃO	229
FLAP-RACK®	228-229, 232-242
FORMA DE PUDIM	170, 179
FORNOS	24-25, 293, 299
FRITADEIRA	295
FUELÓLEO PARA CHAFING DISH	441
FUNDOS PERFORADOS GASTRONORM	199-200, 205, 207, 255
FUNIL	118, 161
FUNIL DOSEADOR	161
GANCHO	118
GARFO	99, 103, 451-453, 456
GARRAFABAR	500
GASTRONORM FUNDO DIFUSOR	203, 347
GASTRONORM INOXIDÁVEL	198-201, 203
GASTRONORM MELAMINA	380-384
GASTRONORM POLICARBONATO	204-205
GASTRONORM POLIPROPILENO	208-209
GASTRONORM VIOLET	210
GEL LUBRIFICANTE SANITÁRIO	137
GELATARIA	148-149, 338-343
GRAMPO DE IDENTIFICAÇÃO	230, 236-237, 241-242
GRELHA PLANA COM PEGAS ALUMÍNIO	89
GRELHADOR	304
GRELHAS GN	88
GRELHAS PASTELARIA	88, 162
INDUÇÃO 3-D MIRAGE	322-323
INOX-PRO	40-44
INSERTOS	288, 292
JARRA	507, 508-511
JARRA ÁGUA	510-511
JARRA DE MEDIÇÃO	144
JARRA PARA INFUSÕES	507
JARRA POLICARBONATO	511
JARRA TERMO	508-509
LÂMINA/ROLO SOBRESSALENTE	136
LÂMPADA MANTENEDORA	331-333
LEITEIRA	504-506
LIDS AVER®	512-517
LIQUIDIFICADORES	319
LUVA SEM DEDOS	145
LUVAS PROTECÇÃO	145
MAÇARICO COZINHA	159
MANGAS DE PASTÉIS	171-172
MANTA REFRIGERADORA	495
MÁQUINA DE CREPES	296
MÁQUINA DE GELADOS	340-342
MÁQUINAS DE GOFRES	296-297
MARCADOR DE TORTAS	157
MARCADORES GIZ	461
MEDITERRANEAN	360

ARTIGO	PÁGINA
MELAMINA APRESENTAÇÃO.....	346-389
MELAMINA SLIM.....	382-383
MESADECORTE.....	140
MESINHA BUFFET.CUBIC.....	421
MICRO-ONDAS.....	293
MINIATURASALUMÍNIO FUNDIÇÃO.....	466
MINIATURASFERROFUNDIDO.....	464-465
MINIATURASMELAMINA.....	386-388
MIRAGE®.....	291, 322-323
MIRAMAR® BATERIAAPRESENTAÇÃO.....	404-405
MIRAMAR® MODELOS.....	406-407
MODELOS.....	406-407
MOINHO PIMENTA.....	484
MOINHO SAL.....	484
MOLDE CAKE.....	163-165, 170, 179
MOLDE FORMA CORAÇÃO.....	169
MOLDE FORMALÁGRIMA.....	169
MOLDE HEXAGONAL.....	169
MOLDE MEIA CANA.....	170
MOLDE NINHO.....	98
MOLDE OVAL.....	165, 169
MOLDE OVO.....	121
MOLDE PARAPIZA.....	91
MOLDE SEMIESFÉRICO.....	152
MOLDES“FLEXIPAN”.....	182-189
MOLDES DE SILICONE.....	177-181
MOLDESPASTELARIA.....	163-166, 168-170, 177-189
MOLDESSILICONE 600 X400.....	180-181
MOLHEIRA.....	485
MOLHEIRABORDA ONDULADA.....	485
MULTIMETAL.....	42, 71
NÚMERO MESA.....	486
PÁ.....	152
PÁ APRESENTAÇÃO.....	376, 467
PÁ BATATASFRTAS.....	109
PÁ FAST-FOOD.....	111
PÁ PASTÉIS.....	112, 451-452
PÁ PEIXE.....	97, 111
PÁ PIZA.....	92
PAINEL INFORMAÇÃO.....	460
PANELAA VAPOR INOX-PRO.....	44
PANELAALUMÍNIO.....	54
PANELA COM TORNEIRA.....	44
PANELA COOL • LINE.....	48-49
PANELA DE PAELHA ESMALTADA GÁS.....	79
PANELA ELÉCTRICA.....	330
PANELA IDEA.....	51
PANELA INOX-PRO.....	40, 44
PANELA TOPLINE.....	47
PANO SILICONE.....	145
PASSADORDE PURÉS.....	118
PERFISDIVISÓRIOS.....	199, 400
PICO/ESPETO.....	29, 487
PINÇA.....	31, 92, 103, 105-109, 454, 456-459, 475, 499
PINÇA BUFETE.....	106-107, 457-458
PINÇA CHARCUTARIA.....	459
PINÇA PARAMARISCO.....	459
PINÇA PASTELARIA.....	458
PINÇA SERVIÇO.....	456-458

ARTIGO	PÁGINA
PINÇASPARA EMPRATAR.....	105
PINCEL.....	156
PIZZABAGS.....	216-217
PLACA“RESERVADO”.....	486
PLACAADAPTADORAANGULAR.....	434
PLACADECORTE.....	138-140
PLACADECORTEVIOLET.....	140
PLACAPROIBIDOFUMAR.....	486
PLACAQUENTE.....	334
PLACAREFRIGERADORA.....	442
PLACASINDUÇÃO.....	284-291
PORCIONADORAPERTÁVEL.....	102
PORTA-CARTÕES.....	490
PORTA-ESPETOS.....	29, 487
PORTA-MENUS.....	490
PORTA-SALGADOS/PORTA-MOLHOS.....	348, 356, 364, 386, 388, 485
PORTA-TALHERES.....	225, 257, 420, 431
POSTESEPARAÇÃO.....	460
PRATOS.....	223, 348-354, 356-358, 360-361, 364, 371-372, 374
PRATOSCOLORIDOS.....	361
PROCESSADORDEALIMENTOS.....	306-307
PROCESSADORVERSÁTILMANUAL.....	136
PROCESSADORESMANUAISDEALIMENTOS.....	123-137
PROTETORACRÍLICOANTI-HÁLITO.....	392
PROTETORANTI-HÁLITO.....	392
STEELPRO 1921. FERRODE FUNDIÇÃO ULTRALEVEINDUÇÃO.....	75
QUADROS PARA BANDEJAS.....	86
QUEBRA-NOZES.....	459
QUEIMADOR ELÉCTRICO.....	159
RACIONADORDE GELADO.....	102, 148
RALADOR.....	113-114
RASPADOR.....	111-112, 122, 157
RECIPIENTEPARAMOLHOS.....	348, 356, 364, 386, 388, 485
RECOLHE-VERDURAS.....	140
REFRIGERADORGARRAFASBUFFET.CUBIC.....	421
REFRIGERADORISOTÉRMICO.....	497
RELÓGIODE COZINHA DIGITAL.....	142
REMO.....	122
RETERMALIZADOR.....	322-329
RETERMALIZADORRETRO.....	324-325
RETERMALIZADORES/AQUECEDORESALIMENTOS.....	322-329
ROLETACORTA-PIZAS.....	111
ROLO.....	155-156
SACA-ROLHAS.....	502
SACA-ROLHASDEPAREDE.....	502
SALADEIRAACRÍLICA.....	449
SAUTEXALUMÍNIO.....	55
SAUTEXINOX-PRO.....	42
SERTÃ“LIONESA”.....	77
SERTÃAÇOESMALTADO.....	78
SERTÃAÇOINOXIDÁVEL.....	64-66
SERTÃALUMÍNIO.....	70
SERTÃALUMÍNIO.....	67-70
SERTÃALUMÍNIO FUNDIÇÃO.....	72-73
SERTÃBLACKSERIES.....	72-72
SERTÃCREPES.....	70, 73-74, 77
SERTÃFUNDA ESMALTADA COM PEGAS.....	78
SERTÃIDEA.....	66
SERTÃINOX-PRO.....	40

ARTIGO	PÁGINA	ARTIGO	PÁGINA
SERTĂMULTIMETAL.....	71	TRAVESSAFONDUECHOCOLATE	334
SERTĂPARABLINIS	70	TRAVESSAFUNDACÓNICA	152
SERTĂSTEELPRO1921	75	TRAVESSAOVAL.....349,352-353, 359, 369, 374, 448, 465	
SERTĂTOPLINE	47	TRIPÉPANELADEPAELHA	79
SERTĂVALENCIANA	78	T-VERSION	230-235
SERTĂS.....	60-77	UTENSÍLIOSCABO MADEIRA.....	112
SERTĂSCOOL•LINE	65	UTENSÍLIOSDE SERVIÇO	451-459
SOLUÇÕESDEDISPENSA.....	512-517	VERSATILMACHINE	133
SPOODLE®	100-101	VIOLETCOLLECTION.....	210
STONE	358	VITRINASAPRESENTAÇÃO	394-395
SUPERPAN® SUPERSHAPES.....	398-400	WOKAÇO.....	75
SUPORTEAPRESENTAÇÃOARDÓSIA-MÁRMORE	379	WOK BLACKSERIES.....	73
SUPORTEAPRESENTAÇÃO MADEIRABRANCA	377	WOK INOX	66
SUPORTEMÁRMORE APRESENTAÇÃO	378-379	WOK MULTIMETAL	71
SUPORTEMESABANDEJAMARISCO	487	WOK STEELPRO.....	75
SUPORTEPARABALDECHAMPANHE.....	497	306-307
SUPORTEPARA BANDEJASDETAMANHO GRANDE.....	487	469
SUPORTEPARA BANDEJASPORTA-TALHERESGN	225		
SUPORTEPARA ESPETOS.CUBIC	419		
SUPORTEPARAMANGAS DE PASTÉIS.....	172		
SUPORTEPARANÚMEROS.....	486		
SUPORTEPARAPASSADORCHINÊSOU FUNIL.....	116		
SUPORTEPARA PLACASDECORTE	202		
SUPORTETAMPASGN	202		
TABULEIRO DE TALHERESPARA CARROSERVIÇO	250		
TAÇA GELADO.....	148		
TACHO ALUMÍNIO	55		
TACHO BOLEADO	42, 55		
TACHO COOL•LINE	49		
TACHO IDEA.....	51		
TACHO INOX-PRO.....	41-42		
TACHO TIPO FRANCÊS.....	41		
TACHOSDE MEDIÇÃO.....	144		
TAMPA BATERIA.....	41, 47, 87		
TAMPA CHAMPANHE	502		
TAMPA CHÁVENAPEQUENO-ALMOÇO	223		
TAMPA GN	199, 203, 205, 207-208		
TAMPA INOX PARAPRATOS	491		
TAMPA INOX-PRO.....	41		
TAMPA PARA CESTO	238		
TAMPA POLINORM®.....	203, 205, 207-208		
TAMPA PRATOS	491		
TAMPA PRATOSPLÁSTICO	491		
TAMPA UNIVERSAL.....	502		
TAMPAS GN TRANSPARENTES	395		
TAPETEDE BARPAR ESCORRERTAÇAS	500		
TAPETEDE SILICONE.....	92		
TAPETES.....	145		
TERMO COM DOSEADOR.....	508-509		
TERMÓMETRO.....	142-143		
TERRACOTA	356-357		
TERRINA.....	449		
TIGELA...223, 348-349, 351, 354, 357-358, 360, 363-364, 366-367, 369-374			
TIGELAESTRADIAINCLINADA	447		
TIGELAPAREDEDUPLA.....	223, 444-447		
TOALHA DE MESA ANTIDESLIZANTEPARA BANDEJA.....	503		
TOALHAS DE MESA INDIVIDUAIS	482-483		
TOP LINE.....	46-47		
TORRADEIRA	298-302		

АРТИКУЛ	СТРАНИЦА
BARKEEP®	500
BLACKFIRST	74
BLACKPRO	72-73
CATERINGBAGS	218-219
CAYENNE®	332-333
CENTURY	53-55
CHARCOALOVEN	24-25
COOL • LINE	48-49, 65
DELIVERYBACKPACKS	220-221
ELEGANCE	359
EPPBOX	215
GASTRONORMМЕЛАМИНОВАЯ ПОСУДА	380-384
LIDSAVER®	512-517
MEDITERRANEAN	360
MIRAGE®	291, 322-323
MIRAMAR® НАБОР КАСТРЮЛЬ ПРЕЗЕНТАЦИОННЫЙ	404-405
MIRAMAR® ТРАФАРЕТЫ	406-407
PIZZABAGS	216-217
SPOODLE®	100-101
STONE	358
SUPERPAN® SUPERSHAPES	398-400
TERRACOTA	356-357
T-VERSION	230-235
АКРИЛОВЫЙ ПРОТЕКТОР ПРОТИВОДЫХАТЕЛЬНЫЙ	392
АЛЮМИНИЕВАЯ ЛИТАЯ МИНИ-КАСТРЮЛЯ	466
АЛЮМИНИЕВЫЙ ПОДНОС С ПРОТИВОПРИГАРНЫМ ПОКРЫТИЕМ	84, 87
БАРНОЕ СИТО СТРЕЙНЕР	499
БАРНЫЙ КОВРИК ДЛЯ СУШКИ БОКАЛОВ	500
БАРЬЕРНЫЕ СТОЛБИКИ	460
БЛЕНДЕРЫ	319
БЛЕНДЕРЫ КУВШИННЫЕ	311-317
БЛЕНДЕРЫ ПОГРУЖНЫЕ	308-310
БЛИННИЦА	296
БРУС ДЛЯ ЗАМЕТОК	122
БУТЫЛКА ДЛЯ БАРА	500
БУФЕТ "CUBIC" ТЕЛЕЖКА БУФЕТНАЯ	428-431
БУФЕТ CUBIC ВИТРИНА	421, 424-425
БУФЕТ CUBIC КУБЫ И ПОЛКИ	422-423
БУФЕТ ДЛЯ НАРЕЗКИ	333
ВЕДРО ДЛЯ ЛЬДА	497
ВЕДРО ДЛЯ МУСОРА НАСТОЛЬНОЕ	488
ВЕДРО ДЛЯ ШАМПАНСКОГО	494-496
ВЕДРО С ОСНОВОЙ	144
ВЕНЧИК	153
ВЕСЛО	122
ВЕСЫ	142
ВИЛКА	99, 103, 451-453, 456
ВИТРИНА GASTRONORM	375
ВИТРИНА ДЛЯ ВЫПЕЧКИ	394-395
ВИТРИНА ТРЕХ-УРОВНЕВАЯ CUBIC	418
ВИТРИНЫ	432-435
ВОРОНКА	118, 161
ВОРОНКА С ДОЗАТОРОМ	161
ВСТАВКИ	288, 292
ГАЗОВАЯ ГОРЕЛКА	159
ГАСТРОЕМКОСТЬ GASTRONORM, БЕЗ ДФП	206-207
ГАСТРОЕМКОСТЬ VIOLET	210
ГЕЛЬ СМАЗОЧНЫЙ САНИТАРНЫЙ	137
ГОРЮЧЕЕ ДЛЯ ЧАФИНДИША	441

АРТИКУЛ	СТРАНИЦА
ГОРЯЧАЯ ПЛИТА	334
ГОФРЕНИЦА	296-297
ГРИЛЬ	304
ДЕЛИТЕЛЬ ДЛЯ ТОРТА	157
ДЕРЖАТЕЛИ ДЛЯ КОНДИТЕРСКИХ МЕШКОВ	172
ДЕРЖАТЕЛЬ ДЛЯ ВИЗИТОК	490
ДЕРЖАТЕЛЬ ДЛЯ КИТАЙСКОГО ДУРШЛАГА ИЛИ ВОРОНКИ	116
ДЕРЖАТЕЛЬ ДЛЯ МЕНЮ	490
ДЕРЖАТЕЛЬ ДЛЯ ПАЛОЧЕК	29, 487
ДЕРЖАТЕЛЬ ДЛЯ ПОДНОСОВ С ПРИБОРАМИ GN	225
ДЕРЖАТЕЛЬ ДЛЯ РАЗДЕЛОЧНЫХ ДОСОК	202
ДЕРЖАТЕЛЬ НОМЕРКОВ	486
ДЖИГЕР	499
ДИСПЕНСЕР ДЛЯ ЗЛАКОВЫХ	443
ДИСПЕНСЕР ДЛЯ МЕШОЧКОВ ЧАЯ И САХАРА CUBIC	421
ДИСПЕНСЕР ДЛЯ МОЛОКА	443
ДИСПЕНСЕР ДЛЯ СОКОВ	443
ДИСПЕНСЕР ПОД ДАВЛЕНИЕМ	119-120
ДИСПЕНСЕР С КОНТРОЛЕМ ПОРЦИЙ	162
ДИСПЕНСЕР С ОДНОРАЗОВЫМИ ПОЛИЭТИЛЕНОВЫМИ ЧЕХЛАМИ	258
ДИСПЕНСЕРЫ	162, 418, 443
ДОСКА ДЛЯ НАРЕЗКИ VIOLET	140
ДОСКА РАЗДЕЛОЧНАЯ	138-140
ДОСКИ	461
ДУРШЛАГ	115-116
ДУРШЛАГ	117
ДУРШЛАГ ДЛЯ МАКАРОННЫХ ИЗДЕЛИЙ	44
ДУХОВЫЕ ШКАФЫ	24-25, 293, 299
ЕМКОСТЬ ДЛЯ ПРЕЗЕНТАЦИИ МЕЛАМИНОВЫХ ПИАЛ CUBIC	423
ЖАРОВНЯ-ГРИЛЬ	73-74
ЗАЩИТНЫЕ ПЕРЧАТКИ	145
ЗАЩИТНЫЙ ВИНИЛОВЫЙ ЧЕХОЛ	261
ИДЕНТИФИКАЦИОННЫЙ ЗНАЧЕК	229
ИДЕНТИФИКАЦИОННЫЙ КЛИП	230, 236-237, 241-242
ИЗОТЕРМИЧЕСКИЙ ОХЛАДИТЕЛЬ	497
ИНВЕНТАРЬ С ДЕРЕВЯННЫМИ РУЧКАМИ	112
ИНДИВИДУАЛЬНЫЕ КОВРИКИ ДЛЯ СЕРВИРОВКИ	482-483
ИНДУКЦИОННАЯ ПЛИТА	284-291
ИНДУКЦИОННАЯ ПЛИТА 3-D MIRAGE	322-323
ИНДУКЦИОННЫЙ НАГРЕВАТЕЛЬ MIRAGE	291-292
ИНФОРМАЦИОННОЕ ТАБЛО	460
КАСТРЮЛЬКА	96, 103, 373, 451-455
КАСТРЮЛЯ COOL • LINE	48-49
КАСТРЮЛЯ IDEA	51
КАСТРЮЛЯ INOX-PRO	40
КАСТРЮЛЯ TOP LINE	47
КАСТРЮЛЯ АЛЮМИНИЕВАЯ	54
КАСТРЮЛЯ ВОК STEELPRO 1921	75
КАСТРЮЛЯ ВОК MULTIMETAL	71
КАСТРЮЛЯ ВОК ИЗ НЕРЖАВЕЮЩЕЙ СТАЛИ	66
КАСТРЮЛЯ ВОК ИЗ СТАЛИ	75
КАСТРЮЛЯ ВОК СЕРИИ BLACK	73
КАСТРЮЛЯ ГЛУБОКАЯ	40, 44
КАСТРЮЛЯ ГЛУБОКАЯ COOL • LINE	48-49
КАСТРЮЛЯ ГЛУБОКАЯ IDEA	51
КАСТРЮЛЯ ГЛУБОКАЯ TOP LINE	47
КАСТРЮЛЯ ГЛУБОКАЯ АЛЮМИНИЕВАЯ	54
КАСТРЮЛЯ ДЛЯ КУС-КУСА	43

Артикул	Страница
КАСТРЮЛЯ ИЗ ЛИТОГО АЛЮМИНИЯ.....	56, 466
КАСТРЮЛЯ ПАРОВАРКА ИЗ НЕРЖАВЕЮЩЕЙ СТАЛИ	44
КАСТРЮЛЯ ПАЗЛЯ INOX-PRO.....	40
КАСТРЮЛЯ ПАЗЛЯ TOP LINE.....	47
КАСТРЮЛЯ ПАЗЛЯ АЛЮМИНИЕВАЯ.....	70
КАСТРЮЛЯ ПАЗЛЯ ВАЛЕНСИЙСКАЯ.....	78
КАСТРЮЛЯ ПАЗЛЯ ИЗ СТАЛИ, ЭМАЛИРОВАННАЯ	78
КАСТРЮЛЯ ПАЗЛЯ, ЭМАЛИРОВАННАЯ, ДЛЯ ГАЗОВОЙ ПЛИТЫ.....	79
КАСТРЮЛЯ С КРАНОМ	44
КАСТРЮЛЯ СЕРИИ BLACK.....	56
КАСТРЮЛЯ-СОУСНИК ИЗ НЕРЖАВЕЮЩЕЙ СТАЛИ	41-42
КАСТРЮЛЯ-СОУСНИК КОНИЧЕСКИЙ.....	42, 55
КАСТРЮЛЯ-СОУСНИК ФРАНЦУЗСКОГО ТИПА	41
КИСТОЧКА.....	156
КИТАЙСКИЙ ДУРШЛАГ.....	116
КОВРИКИ.....	145
КОКТЕЙЛЬ	498-499
КОЛЛЕКЦИЯ VIOLET	210
КОЛЬЦО	168
КОЛЬЦО ДЛЯ БУТЫЛКИ ВИНА.....	502
КОНТЕЙНЕР ДЛЯ ПРИБОРОВ.....	225, 257, 420, 431
КОРЗИНА ДЛЯ БОЛЬШИХ ПОДНОСОВ.....	242
КОРЗИНА ДЛЯ ИЗОТЕРМИЧЕСКИХ ПОДНОСОВ	242
КОРЗИНКА ДЛЯ ПРИБОРОВ.....	238, 481
КОРЗИНКА ДЛЯ ПРИБОРОВ.....	238
КОРЗИНКА СЕТЧАТАЯ	432
КОРЗИНКА ХЛЕБНАЯ	476-481
КОРЗИНЫ ДЛЯ ТАРЕЛОК	240-242
КОРЗИНЫ ЗАКРЫТЫЕ	236-237
КОРЗИНЫ ОТКРЫТЫЕ.....	232-235
КОРЗИНЫ ПОЛИПРОПИЛЕНОВЫЕ	478-481
КОРОБКА GN БАМБУКОВАЯ.....	433
КОРОБКА ДЛЯ ПРИПРАВ.....	501
КОТЕЛ.....	151
КОФЕЦНИЦА	505-506
КРЫШКА GN	199, 203, 205, 207-208
КРЫШКА POLINORM®	203, 205, 207-208
КРЫШКА ДЛЯ КАСТРЮЛЬ.....	41, 47, 87
КРЫШКА ДЛЯ КОРЗИНЫ	238
КРЫШКА ДЛЯ ТАРЕЛОК.....	491
КРЫШКА ИЗ НЕРЖАВЕЮЩЕЙ СТАЛИ.....	41
КРЫШКА НА ЧАШКУ ДЛЯ ЗАВТРАКА.....	223
КРЮЧОК.....	118
КУВШИН.....	507, 508-511
КУВШИН ДЛЯ ВОДЫ	510-511
КУВШИН ИЗ ПОЛИКАРБОНАТА.....	511
КУВШИН-ТЕРМОС.....	508-509
КУХОННЫЙ ПРОЦЕССОР	306-307
ЛАМПА ПОДОГРЕВА.....	331-333
ЛЕЙКА ДЛЯ МАСЛА.....	122
ЛЕНТА КОНДИТЕРСКАЯ ИЗ ПВХ ДЛЯ МУССА.....	169
ЛИМОНОВЫЖИМАЛКА.....	499
ЛОЖКА.....	98-99, 102-103, 154, 373, 386, 451-456
ЛОЖКА ДЛЯ СМАЗКИ	112
ЛОЖКА КОКТЕЙЛЬНАЯ	499
ЛОЖКА СЕРВИРОВОЧНАЯ	103, 451-452, 454-456
ЛОМТЕРЕЗКА.....	127-128
ЛОПАТКА ДЛЯ КАРТОФЕЛЬНЫХ ЧИПСОВ	109
ЛОПАТКА ДЛЯ ПИЦЦЫ.....	92

Артикул	Страница
ЛОПАТКА ДЛЯ РЫБЫ	97, 111
ЛОПАТКА ДЛЯ СБОРА ОВОЩЕЙ.....	140
ЛОПАТКА ДЛЯ ТОРТОВ	112, 451-452
ЛОПАТКА ДЛЯ ФАСТ-ФУДА.....	111
ЛОПАТКА	97, 103, 110-112, 154, 451-456
ЛОТКИ ДЛЯ МОРОЖЕНОГО	149
МАНДОЛИНЫ	137
МАШИНА "VERSATILMACHINE"	133
МЕЛАМИНОВАЯ ЁМКость SLIM	382-383
МЕЛАМИНОВАЯ ПОСУДА ДЛЯ ПРЕЗЕНТАЦИИ.....	346-389
МЕЛКИ ДЛЯ ОТМЕТОК.....	461
МЕЛЬНИЦА ДЛЯ ПЕРЦА.....	484
МЕЛЬНИЦА ДЛЯ СОЛИ	484
МЕНЗУРКА	144
МЕРНЫЕ ЛОЖКИ	144
МЕТАЛЛИЧЕСКАЯ ЩЕТКА	122
МЕШКИ КОНДИТЕРСКИЕ	171-172
МИКРОВОЛНОВАЯ ПЕЧЬ.....	293
МИНИАТЮРЫ ИЗ МЕЛАМИНА	386-388
МИНИАТЮРЫ ЧУГУННЫЕ.....	464-465
МИСКА КОНИЧЕСКАЯ	152
МОЛОЧНИК	504-506
МОРОЖЕНИЦА.....	340-342
МОРОЖЕНОЕ.....	148-149, 338-343
МРАМОРНАЯ ПОДСТАВКА ДЛЯ ПРЕЗЕНТАЦИИ.....	378-379
НАБОР КАСТРЮЛЬ IDEA.....	50-51
НАБОР КАСТРЮЛЬ ПРЕЗЕНТАЦИОННЫЙ	402-407
НАБОР КАСТРЮЛЬ ЦВЕТНОЙ	49
НАБОРЫ CUBIC.....	414-417
НАБОРЫ ДЛЯ СПЕЦИЙ.....	120
НАГРЕВАТЕЛИ	329-330
НАКАЛЫВАТЕЛЬ ДЛЯ ЗАМЕТОК.....	487
НАСАДКА.....	173-176
НАСАДКА ИЗ ПОЛИКАРБОНАТА	176
НАСТОЛЬНАЯ ПОДСТАВКА ПОД ПОДНОС ДЛЯ МОРЕПРОДУКТОВ.....	487
НАСТОЛЬНЫЙ МИКСЕР.....	306
НАТУРАЛЬНЫЙ БАМБУК И ДЕРЕВО	474-475
НЕРЖАВЕЮЩАЯ КРЫШКА ДЛЯ ТАРЕЛОК	491
НОЖ.....	451, 453, 456
НОЖ / ЗАПАСНОЙ ВАЛИК	136
НОЖ ДЛЯ НАРЕЗКИ КАРТОФЕЛЯ ФРИ.....	129
НОЖ ДЛЯ РЕЗКИ ТОМАТОВ	135
НОЖ ДЛЯ РЕЗКИ ЯБЛОК И ВЫЕМКИ СЕРДЦЕВИНЫ.....	136
НОЖ ДЛЯ РЕЗКИ ЯИЦ	136
НОМЕРА ДЛЯ СТОЛОВ	486
ОВАЛЬНОЕ БЛЮДО	349, 352-353, 359, 369, 374, 448, 465
ОВАЛЬНЫЙ ПОДНОС.....	487
ОСНОВА ДЛЯ ПИЦЦЫ	91
ОТКРЫВАЛКА ПРОМЫШЛЕННАЯ	136
ОХЛАДИТЕЛЬ БУТЫЛОК ДЛЯ БУФЕТА CUBIC.....	421
ОХЛАДИТЕЛЬНАЯ ПАНЕЛЬ	442
ОХЛАДИТЕЛЬНЫЙ ЧЕХОЛ.....	495
ПАНЕЛЬ УГЛОВАЯ АДАПТИРОВОЧНАЯ	434
ПАРОВАРКА.....	42, 329, 334, 442
ПЕПЕЛЬНИЦА	389, 488
ПЕРФОРИРОВАННОЕ ДНО GASTRONORM.....	199-200, 205, 207, 255
ПИАЛА.....	223, 348-349, 351, 354, 357-358, 360, 363-364, 366-367, 369-374
ПИАЛА С ДВОЙНЫМИ СТЕНКАМИ	223, 444-447
ПИАЛА УДЛИНЕННАЯ С НАКЛОНОМ	447

Артикул	Страница
ПЛАСТМАССОВАЯ КРЫШКА ДЛЯ ТАРЕЛОК	491
ПЛАСТМАССОВОЕ ВЕДРО ДЛЯ ЛЬДА	494-495
ПЛОСКАЯ СКОВОРОДА-ГРИЛЬ С АЛЮМИНИЕВЫМИ РУЧКАМИ	89
ПОДНОС	84-87, 90, 222, 224, 351, 353, 355-356, 359, 366-375
ПОДНОС GASTRONORM	84
ПОДНОС ДЛЯ ПРЕЗЕНТАЦИИ	375
ПОДНОС ДЛЯ ПРИБОРОВ	225
ПОДНОС ДЛЯ САМООБСЛУЖИВАНИЯ ИЗ НЕРЖ.СТАЛИ	224
ПОДНОС ИЗОТЕРМИЧЕСКИЙ	222
ПОДНОС КОНДИТЕРСКИЙ	86-87, 90, 375
ПОДНОС ОФИЦИАНТА	503
ПОДНОС ФАСТ-ФУД	224
ПОДНОСЫ SUBIC	420
ПОДНОСЫ ИЗ СТЕКЛОВОЛОКНА	224
ПОДНОСЫ С ПРОТИВОСКОЛЬЗЯЩИМ ПОКРЫТИЕМ	381, 503
ПОДОГРЕВАТЕЛИ ПИЦЦЫ	322-329
ПОДОГРЕВАТЕЛЬ	322-329
ПОДОГРЕВАТЕЛЬ РЕТРО	324-325
ПОДОГРЕВАТЕЛЬ ТАРЕЛОК	337
ПОДСАЛФЕТНИК	489
ПОДСТАВКА ДЛЯ КРЫШЕК GN	202
ПОДСТАВКА ДЛЯ ПОДНОСОВ БОЛЬШОГО РАЗМЕРА	487
ПОДСТАВКА ДЛЯ ТОРТА	160
ПОДСТАВКА ДЛЯ ШПАЖЕК. SUBIC	419
ПОДСТАВКА ПОД ВЕДРО ДЛЯ ШАМПАНСКОГО	497
ПОДСТАВКА ПРЕЗЕНТАЦИОННАЯ ИЗ БЕЛОГО ДЕРЕВА	377
ПОЛКИ	263-281
ПОРЦИОНАЯ ЛОЖКА С НАЖАТИЕМ	102
ПОРЦИОННАЯ ЛОЖКА ДЛЯ МОРОЖЕНОГО	102, 148
ПРЕЗЕНТАЦИОННАЯ ВИТРИНА	394-395
ПРЕЗЕНТАЦИОННАЯ ЛОПАТКА	376, 467
ПРЕЗЕНТАЦИОННАЯ ПОДСТАВКА ДЛЯ ШПАЖЕК. SUBIC	419
ПРИСПОСОБЛЕНИЯ ДЛЯ ДОЗИРОВАНИЯ	512-517
ПРОБКА ДЛЯ ШАМПАНСКОГО	502
ПРОЗРАЧНЫЕ КРЫШКИ GN	395
ПРОТЕКТОР ПРОТИВОДЫХАТЕЛЬНЫЙ	392
ПРОТИВОМИКРОБНЫЙ	100-101
ПРОФИЛЬ РАЗДЕЛИТЕЛЬНЫЙ	199, 400
ПРОЦЕССОР РУЧНОЙ АДАПТИРУЕМЫЙ	136
ПРОЦЕССОРЫ РУЧНЫЕ ДЛЯ ПЕРЕРАБОТКИ ПРОДУКТОВ	123-137
ПЮРЕШНИЦА	118
РАМКИ ДЛЯ ПОДНОСОВ	86
РАСПРЕДЕЛИТЕЛЬ ДЛЯ СОКА	417-418
РЕГУЛИРУЕМАЯ ТЕЛЕЖКА ДЛЯ ТАРЕЛОК	260
РЕШЕТКИ GN	88
РЕШЕТКИ КОНДИТЕРСКИЕ	88, 162
РИСОВАРКА	296
РОЛИК ДЛЯ НАРЕЗКИ ПИЦЦЫ	111
РУКАВИЦА	145
САЛАТНИЦА АКРИЛЛОВАЯ	449
САЛФЕТНИЦА SUBIC	421
САХАРНИЦА	505
СЕРВИРОВОЧНЫЕ ПРИНАДЛЕЖНОСТИ	451-459
СЕРИИ BLACK	56
СЕРИЯ GASTRONORM ИЗ ПОЛИКАРБОНАТА	204-205
СЕРИЯ GASTRONORM С УТОЛЩЕННЫМ ДНОМ СЭНДВИЧ203, 347	
СЕРИЯ FLAP-RACK®	228-229, 232-242
СЕРИЯ GASTRONORM ИЗ ПОЛИПРОПИЛЕНА	208-209
СЕРИЯ GASTRONORM, НЕРЖ.СТАЛЬ	198-201, 203

Артикул	Страница
СЕРИЯ INOX-PRO	40-44
СЕРИЯ MULTIMETAL	42, 71
СЕРИЯ JUJADAS 1921. ЧУГУН С ВЕРХНЕГКИМ ДЛЯ ИНДУКЦИОННЫХ ПЛИТ	75
СЕРИЯ TOP LINE	46-47
СИЛИКОНОВАЯ ЛЕНТА ДЛЯ ЗАКУПОРКИ	202
СИЛИКОНОВАЯ САЛФЕТКА	145
СИЛИКОНОВАЯ САЛФЕТКА	92
СИТО	160
СКАЛКА ДЛЯ ТЕСТА	155-156
СКАТЕРТЬ ПРОТИВОСКОЛЬЗЯЩАЯ ДЛЯ ПОДНОСА	503
СКОВОРОДА "LYONNAISE"	77
СКОВОРОДА IDEA	66
СКОВОРОДА MULTIMETAL	71
СКОВОРОДА STEELPRO 1921	75
СКОВОРОДА АЛЮМИНИЕВАЯ	67-70
СКОВОРОДА АЛЮМИНИЕВАЯ	72-73
СКОВОРОДА ГЛУБОКАЯ, ЭМАЛИРОВАННАЯ, С РУЧКАМИ	78
СКОВОРОДА ГРИЛЬ	82-83, 89
СКОВОРОДА ДЛЯ БЛИНОВ	70
СКОВОРОДА ДЛЯ ФРАНЦУЗСКИХ БЛИНОВ	70, 73-74, 77
СКОВОРОДА СЕРИИ BLACK	72-72
СКОВОРОДА, НЕРЖ.СТАЛЬ	64-66
СКОВОРОДЫ	60-77
СКОВОРОДЫ COOL • LINE	65
СКРЕБОК	111-112, 122, 157
СКРЕБОК ДЛЯ СБОРА КРОШЕК	488
СКРЕБОК ДЛЯ ЧИСТКИ РЫБЫ	122
СЛАЙСЕР	132
СЛАЙСЕР ДЛЯ ЗЕЛЕННОГО САЛАТА	130
СЛАЙСЕР ДЛЯ КУБИКОВ	133
СЛАЙСЕР ДЛЯ ЛУКА	131
СЛАЙСЕР ДЛЯ ФРУКТОВ И ОВОЩЕЙ	131
СЛАНЦЕВО-МРАМОРНАЯ ПОДСТАВКА ДЛЯ ПРЕЗЕНТАЦИИ	379
СЛАНЦЕВЫЕ ДОСКИ ДЛЯ ПРЕЗЕНТАЦИИ	472-473
СОВОК	152
СОСУД ДЛЯ СОУСОВ	348, 356, 364, 386, 388, 485
СОТЕЙНИК АЛЮМИНИЕВЫЙ	55
СОТЕЙНИК ИЗ НЕРЖАВЕЮЩЕЙ СТАЛИ	42
СОУСНИК	485
СОУСНИК / НАБОР ДЛЯ ЗАКУСКИ	348, 356, 364, 386, 388, 485
СОУСНИК COOL • LINE	49
СОУСНИК IDEA	51
СОУСНИК АЛЮМИНИЕВАЯ	55
СОУСНИК С ВОЛНИСТЫМ КРАЕМ	485
СТАКАН	223, 360
СТЕНД ДЛЯ ГАСТРОЕМОСТЕЙ GN	202, 385
СТОЛ ДЛЯ НАРЕЗКИ	140
СТОЛИК БУФЕТНЫЙ SUBIC	421
СУПНИЦА	449
ТАБЛИЧКА "ЗАРЕЗЕРВИРОВАНО"	486
ТАБЛИЧКА "НЕ КУРИТЬ"	486
ТАРЕЛКИ	223, 348-354, 356-358, 360-361, 364, 371-372, 374
ТАРЕЛКИ ЦВЕТНЫЕ	361
ТЕЛЕЖКА GUERIDON	430
ТЕЛЕЖКА ДВОЙНАЯ ДЛЯ ПОДНОСОВ ФАСТ-ФУД	256
ТЕЛЕЖКА ДЕРЕВЯННАЯ	428-431
ТЕЛЕЖКА ДЛЯ ГАСТРОЕМОСТЕЙ GASTRONORM	251-255
ТЕЛЕЖКА ДЛЯ КОРЗИНОК	259
ТЕЛЕЖКА ДЛЯ ЛЬДА	261

АРТИКУЛ	СТРАНИЦА
ТЕЛЕЖКАДЛЯ ПРИБОРОВ.....	257, 431
ТЕЛЕЖКАДЛЯ РАЗМОРАЖИВАНИЯ.....	255
ТЕЛЕЖКАДЛЯ РАЗМОРАЖИВАНИЯ GASTRONORM.....	255
ТЕЛЕЖКАДЛЯ СБОРА ПОСУДЫ.....	246, 250
ТЕЛЕЖКАДЛЯ ТЯЖЕЛЫХГРУЗОВ.....	258
ТЕЛЕЖКАПЛАСТМАССОВАЯ.....	246, 251-261
ТЕЛЕЖКАС НАПРАВЛЯЮЩИМИ.....	251-256, 258-259
ТЕЛЕЖКАС НАПРАВЛЯЮЩИМИ, РАЗБОРНАЯ.....	251-254
ТЕЛЕЖКАС РАБОЧЕЙ ПОВЕРХНОСТЬЮ.....	258
ТЕЛЕЖКАСЕРВИРОВОЧНАЯ АЛЮМИНИЕВАЯ.....	246
ТЕЛЕЖКАСЕРВИРОВОЧНАЯ ИЗ НЕРЖ. СТАЛИ.....	247-250
ТЕЛЕЖКАСЕРВИРОВОЧНАЯ РАЗБОРНАЯ.....	249
ТЕЛЕЖКАШПИЛЬКА.....	252-253
ТЕПЛОЙ ШКАФ.....	335-336
ТЕРКА.....	113-114
ТЕРМОМЕТР.....	142-143
ТЕРМОСС ДОЗАТОРОМ.....	508-509
ТОСТЕР.....	298-302
ТОЧИЛО ДЛЯ НОЖЕЙ.....	319
ТРАФАРЕТЫ.....	406-407
ТРЕНОЖНИК ДЛЯ КАСТРЮЛИ ПАЭЛЬЯ.....	79
ТЯПКА ДЛЯ ОТБИВАНИЯ МЯСА.....	121
УКОМПЛЕКТОВАННЫЕ НАБОРЫ ПОЛОК.....	268-274
УНИВЕРСАЛЬНАЯКОНЗИНКА.....	238
УНИВЕРСАЛЬНАЯПРОБКА.....	502
УЧРЕЖДЕНИЯ.....	222-225
ФОНТАН ДЛЯ ШОКОЛАДНОГО ФОНДЮ.....	334
ФОРМА ГНЕЗДО.....	98
ФОРМА ДЛЯ ВЫПЕЧКИ "СЛЕЗА".....	169
ФОРМА ДЛЯ ВЫПЕЧКИ "КЕЙК".....	163-165, 170, 179
ФОРМА ДЛЯ ВЫПЕЧКИ "СЕРДЦЕ".....	169
ФОРМА ДЛЯ ВЫПЕЧКИ ОВАЛЬНАЯ.....	165, 169
ФОРМА ДЛЯ ВЫПЕЧКИ ПОЛУСФЕРА.....	152
ФОРМА ДЛЯ ВЫПЕЧКИ ШЕСТИУГОЛЬНАЯ.....	169
ФОРМА ДЛЯ ПИЦЦЫ.....	91
ФОРМА ДЛЯ РУЛЕТА.....	170
ФОРМА ДЛЯ ЯЙЦА.....	121
ФОРМА-СТАКАНЧИК ДЛЯ ФЛАНА.....	170, 179
ФОРМЫ ДЛЯ ВЫПЕЧКИ "FLEXIRAN".....	182-189
ФОРМЫ ДЛЯ ВЫПЕЧКИ СИЛИКОНОВЫЕ.....	177-181
ФОРМЫ ДЛЯ ВЫРЕЗАНИЯ ТЕСТА.....	155, 167
ФОРМЫ КОНДИТЕРСКИЕ.....	163-166, 168-170, 177-189
ФОРМЫ СИЛИКОНОВЫЕ 600 X 400.....	180-181
ФРИТЮРНИЦА.....	295
ЦИФРОВЫЕ КУХОННЫЕ ЧАСЫ.....	142
ЧАЙНИК.....	505-507
ЧАЙНИК С ФИЛЬТРОМ.....	507
ЧАЙНИЧЕК ДЛЯ ТРАВЯНОГО ЧАЯ.....	507
ЧАФИНГ-ДИШ.....	437-440
ЧАФИНГ-ДИШ INTRIGUE.....	437
ЧАФИНГ-ДИШ ЭКОНОМИЧНЫЕ.....	440
ЧАФИНГ-ДИШ, ДОПОЛНИТЕЛЬНЫЕ ПРИНАДЛЕЖНОСТИ.....	437, 441
ЧАША.....	223, 373
ЧАША ДЛЯ МОРОЖЕНОГО.....	148
ШАМПАНИЦА.....	494-497
ШАМПАНИЦА, ДОПОЛНИТЕЛЬНЫЕ ПРИНАДЛЕЖНОСТИ.....	502
ШАМПУР / ПАЛОЧКА.....	29, 487
ШЕЙКЕР.....	498
ШТОПОР.....	502

АРТИКУЛ	СТРАНИЦА
ШТОПОР НАСТЕННЫЙ.....	502
ШУМОВКА.....	97-98, 103, 451-454
ШУМОВКА СЕТЧАТАЯ.....	98
ЩЕПЦЫ СЕРВИРОВОЧНЫЕ.....	456-458
ЩИПЦЫ.....	31, 92, 103, 105-109, 454, 456-459, 475, 499
ЩИПЦЫ ДЛЯ БУФЕТА.....	106-107, 457-458
ЩИПЦЫ ДЛЯ ВЫПЕЧКИ.....	458
ЩИПЦЫ ДЛЯ КОЛБАСНЫХ ИЗДЕЛИЙ.....	459
ЩИПЦЫ ДЛЯ КОЛКИ ОРЕХОВ.....	459
ЩИПЦЫ ДЛЯ МОРЕПРОДУКТОВ.....	459
ЩИПЦЫ СЕРВИРОВОЧНЫЕ.....	105
ЭЛЕКТРИЧЕСКАЯКАСТРЮЛЯ.....	330
ЭЛЕКТРИЧЕСКАЯЛАМПА.....	159
ЭЛЕКТРИЧЕСКИЙ ЭЛЕМЕНТ ДЛЯ ЧАФИНДИША.....	441
ЭЛЕКТРИЧЕСКИЙ СЛАЙСЕРДЛЯ КОЛБАСНЫХ ИЗДЕЛИЙ.....	307
ЯЩИК ДЛЯ ПРИБОРОВ ДЛЯ СЕРВИРОВОЧНОЙ ТЕЛЕЖКИ.....	250
.....	306-307
.....	469

ÍNDICE NUMÉRICO / NUMERICAL INDEX /
INDEX NUMÉRIQUE / NUMAMERISCHER INDEX

REF.	PAG.	REF.	PAG.	REF.	PAG.	REF.	PAG.	REF.	PAG.
0643SGN	135	1612-06	503	40762	306	4659260	445	47398	102
0644N	135	1811	133	40763	306	46665	447	47399	102
0653	135	1812	133	40764	306	46666	447	47403	102
0654	135	1823	133	40765	307	46667	447	4741-06	501
1009-01	230	19196	434	40766	307	46668	447	4743-06	501
1009-02	230	2208-1354	119	40767	307	46671	333	4747	501
1009-03	230	2331-99	500	40768	307	46672	333	47488	223
1009-04	230	26120-13	120	40769	307	46714	485	47490	323
1009-05	230	26240-13	120	40770	307	46716	485	47602	502
1009-06	230	26320-13	120	40771	307	46791	498	47612	498
1009-08	230	2803-18	162	40772	307	46793	498	47619	447
1009-19	230	2808-13	119	40773	307	4689760	102	4761915	445
1009-32	230	2812-13	119	40774	307	4689815	102	4761925	445
1078-13	491	2908-13	120	40775	307	4689830	102	4761950	445
1400	137	2912-13	120	40776	307	4689840	102	4761960	445
1474-0606	503	306	132	435	130	4689850	102	47632	447
1476-0606	503	308	132	4400N	130	4689860	102	4763215	445
15000	128	3100020	400	4408	130	4689960	102	4763225	445
15001	128	3100040	400	45749-1	129	46926	457	4763250	445
15002	128	3100220	400	45751-1	129	46928	458	4763260	445
15005	128	3100240	400	46009	435	46929	459	47634	447
15006	128	3100320	400	4600960	435	46938	457	4763415	445
15007	128	3100321	400	46110	334	47002	153	4763425	445
15016	128	3100340	400	46115	334	47003	153	4763450	445
15017	128	3100341	400	46125	437	47004	153	4763460	445
15050	128	3101015	399	46130	437	47005	153	47635	447
15052	128	3101020	399	46131	437	47046	108	4763515	445
15053	128	3101040	399	46134	437	47049	108	4763525	445
15054	128	3101120	399	46135	437	47104	499	4763550	445
15055	128	3101220	399	46136	437	47139	102	4763560	445
15058	128	3101240	399	46137	437	47140	102	47637	447
15059	128	3102015	399	4635210	443	47141	102	47713	129
15060	128	3102020	399	46527	325	47142	102	47714	129
15061	128	3102040	399	46569	447	47143	102	4780610	108
15062	128	3102120	400	46575	447	47144	102	4780620	107
15063	128	3102220	399	46576	447	47145	102	4780630	107
15064	128	3316-13	119	46577	447	47146	102	4780640	107
15065	128	3316-13191	119	46582	447	47150	148	4780650	107
15067	128	3332-13	119	46584	447	47151	148	4780660	107
15068	128	3616	500	46585	447	47153	148	4780670	107
15069	128	3628	500	46586	447	47155	148	4780910	108
15070	128	3632	500	46587	447	47157	148	4780912	108
15072	128	3648	500	4658715	445	47159	148	4780920	107
15073	128	3664	500	4658725	445	47160	148	4780930	107
15076	128	3821-06	516	4658750	445	47161	148	4780940	107
15078	128	3825-06	516	4658760	445	47274	148	4780950	107
15081	128	400N	130	46590	447	47275	148	4780960	107
15082	128	402NC	130	4659015	445	47276	148	4780970	107
15083	128	403NH	131	4659025	445	47277	148	4781210	31
15085	128	4075502	306	4659050	445	47278	148	4781212	108
15086	128	4075503	306	4659060	445	47279	148	4781220	107
15103	135	4075602	306	46591	447	47325	109	4781230	107
15105	135	4075603	306	4659115	445	47326	109	4781240	107
15113	135	4075702	307	4659125	445	47390	102	4781250	107
15114	135	4075703	307	4659150	445	47391	102	4781260	107
15115	135	4075802	307	4659160	445	47392	102	4781270	107
15149	137	4075803	307	46592	447	47393	102	4781610	31
15209	135	4075902	307	4659215	445	47395	102	4781620	107
15601	131	4075903	307	4659225	445	47396	102	4781630	107
15604	131	40761	306	4659250	445	47397	102	4781640	107

ÍNDICE NUMÉRICO / NUMERICAL INDEX /
INDEX NUMÉRIQUE / NUMAMERISCHER INDEX

REF.	PAG.	REF.	PAG.	REF.	PAG.	REF.	PAG.	REF.	PAG.
4781650	107	511	131	62321	491	75015	400	86129	224
4781660	107	521030	318	62326	491	7512-06	517	88184	223
4781670	107	521035	318	64130	99	78204	328	88204	223
4791210	31	52160	509	64132	99	78710	442	9002	90
4791610	31	52162	509	6414015	99	78720	442	918-13	491
47933	152	52164	509	6414030	99	78725	442	ADC-4	260
47934	152	52170	509	6414040	99	78730	442	ADP	261
47935	152	52172	509	6414050	99	78740	442	BB255E	313
47938	152	52174	509	6414070	99	78760	442	BB300E	313
47943	152	5220	90	6414215	99	808N	132	BB340E	313
4804-06	517	5223	90	6414230	99	82060	448	BCT6860B	486
4806-06	517	5228	90	6414240	99	82061	448	CAC132	313
4808715	110	52643	238	6414250	99	82062	448	CAC134	313
4808720	110	5284120	110	6414270	99	82093	448	CAC139	315
4808820	110	5284220	102	6433230	101	82094	448	CAC93XI	317
4808920	110	5284320	102	6433335	101	82095	448	CAC95I	317
48144	453	5303	90	6433445	101	8242010	406	CADJ-1	516
48148	453	5324-13	120	6433655	101	8242014	406	CADJ-2	516
4842-06	517	55457	127	6433865	101	8242310	406	CADJ-3	514
4843-06	517	55458	127	6525-13	517	8242314	406	CT2-23035002	299
484C	130	55459	127	6954702	289	8242414	406	CT2-23035003	299
485	130	55460	127	6954703	289	8242514	406	CT4-2301000	298
49130	437	55470	127	700-1	132	8242610	406	CT4-23080002	298
49136	437	55471	127	700-4	132	8242614	406	CT4-23080003	298
4916-13	119	55472	127	704	132	8242710	406	CTC-3X2V	517
4924-13	119	55473	127	706	132	8242714	406	CTNO-06	517
4932-13	119	55477	127	708	132	8242810	407	CTS1000E	300
49410	404	55478	127	712	132	8242814	407	ICE140-06	261
49411	404	55479	127	7217310	325	8242914	407	INC-80	514
49412	404	55480	127	7217350	325	8243014	407	INC-80S18	516
49413	404	55481	127	7217355	325	8243114	407	J1-L-T5	515
49414	415	55482	127	7217360	325	8243210	407	J2H-LL-T5-T5	515
49417	404	55483	127	7217410	325	8243214	407	J2V-LL-T5-T5	515
49418	404	55484	127	7217450	325	8243314	407	J3V-LLL-T5-T5-T5	515
49419	415	55485	127	7217455	325	86100	224	K1-L	514
49420	404	55486	127	7217460	325	86101	224	K1LLDS-T1	515
49423	415	55490	127	7217810	325	86103	224	K2H-LC-T1-T2	514
49424	404	55491	127	7217850	325	86104	224	K2H-LL-T1-T1	514
49425	415	55492	127	7217855	325	86105	224	K2H-LP-T1-T4	514
49426	415	55493	127	7217860	325	86106	224	K2VLCCLDS-T1-T2	515
49428	404	55494	127	7217910	325	86107	224	K2V-LC-T1-T2	514
49429	415	55495	127	7217950	325	86108	224	K2VLLLDST1-T1	515
49431	415	595027502	291	7217955	325	86109	224	K2V-LL-T1-T1	514
49433	415	595027503	291	7217960	325	86110	224	K2V-LP-T1-T4	514
49435	415	595087502	291	72522	328	86111	224	K3H-LCC-T1-T2-T2	514
4961-1301	120	595087503	291	72550	329	86113	224	K3H-LCP-T1-T2-T4	514
4961-1308	120	59601	288	72630	329	86114	224	K3H-LCS-T1-T2-T3	514
4961-13191	120	59602	288	74110210	223	86115	224	K3H-LLL-T1-T1-T1	514
4961-1332	120	59641	292	74110240	223	86116	224	K3VLCCLDS-T1-T2-T2	515
4980120	96	59642	292	741102D	223	86117	224	K3V-LCC-T1-T2-T2	514
4980230	96	59650	288	74110310	223	86118	224	K3V-LCP-T1-T2-T4	514
4980335	96	59651	288	74110340	223	86119	224	K3V-LCS-T1-T2-T3	514
4980422	325	6001X	319	741103D	223	86120	224	K3V-LLL-T1-T1-T1	514
4980445	96	606N	132	7470210	223	86121	224	K4H-LCCC-T1-T2-T2-T2514	
4980622	325	62300	491	7470240	223	86123	224	K4H-LCCP-T1-T2-T2-T4514	
4980655	96	62303	491	74702D	223	86124	224	K4H-LCCS-T1-T2-T2-T3514	
4980865	96	62312	491	7470310	223	86125	224	K4H-LLCC-T1-T1-T2-T2514	
500N	131	62313	491	7470340	223	86126	224	K4V-LCCC-T1-T2-T2-T2514	
501N	131	62315	491	74703D	223	86127	224	K4V-LCCP-T1-T2-T2-T4 514	
509	131	62318	491	75013	400	86128	224	K4V-LCCS-T1-T2-T2-T3 514	

**ÍNDICE NUMÉRICO / NUMERICAL INDEX /
INDEX NUMÉRIQUE / NUMAMERISCHER INDEX**

REF.	PAG.	REF.	PAG.	REF.	PAG.	REF.	PAG.	REF.	PAG.
K4V-LLCC-T1-T1-T2-T2	514	P100741	478	P1100BF	207	P114070	83	P1206F3G	397
K4X-LCCC-T1-T2-T2-T2	514	P100742	478	P1100C1	205	P114540	83	P1206F3N	397
K4X-LCCP-T1-T2-T2-T4	514	P100754	478	P1100P1	201	P114545	83	P1206F3R	397
K4X-LCCS-T1-T2-T2-T3	514	P100755	478	P1100P2	201	P115000	199	P1206P1	208
K4X-LLCC-T1-T1-T2-T2	514	P100760	478	P1100P3	201	P1150BF	207	P120820	67
LD2-2	516	P100761	478	P1100P6	210	P1150C1	205	P120824	67
LD3-2	516	P100770	478	P110201	198	P115320	54	P120828	67
LDS-4CUP	517	P100780	478	P110202	200	P115324	54	P120832	67
LS03G-LS03H	514	P100792	479	P110401	198	P115340	54	P120920	67
LS03IB-T1	515	P100803	479	P110402	200	P116324	54	P120924	67
LS03IS18B-T1	515	P100804	479	P110551	198	P116328	54	P120928	67
LS03IVB-T1	515	P100805	479	P110552	200	P116332	54	P120932	67
LS03J-LS03M	515	P100807	477	P110651	198	P116335	54	P121001	198
LS03MS18B-T5	515	P100808	477	P110652	200	P116340	54	P121002	200
LS03MVS18B-T5	515	P100813	479	P1106BF	206	P116345	54	P1210BF	206
LS03PB-T1	515	P100814	479	P1106C1	204	P116350	54	P1210C1	204
LS03PS18B-T1	515	P100816	477	P1106F1	203	P116360	54	P1210P1	208
LS03PVB-T1	515	P100817	477	P1106F3	397	P117324	54	P121501	198
M1-L-T1	514	P100820	479	P1106F3A	397	P117328	54	P121502	200
M2V-LL-T1-T1	514	P100821	479	P1106F3G	397	P117332	54	P1215BF	206
M3V-LLL-T1-T1-T1	514	P100826	477	P1106F3N	397	P117335	54	P1215C1	204
M4V-4L-T1-T1-T1-T1	514	P100827	477	P1106F3R	397	P117340	54	P1215P1	208
MBA92821	392	P100836	477	P1106P1	208	P117345	54	P1215P6	210
MX1000TXEE	317	P100837	477	P111001	198	P117350	54	P122001	198
MX1100TXSEE	317	P100838	477	P111002	200	P117360	54	P122002	200
MX1200TXEE	316	P100840	480	P1110BF	206	P118324	54	P122040	83
MX1500TXSEE	316	P100841	480	P1110C1	204	P118328	54	P122050	83
N-0001B	202	P100851	480	P1110F1	203	P118332	54	P122060	83
N-0002B	202	P100860	480	P1110F2	203	P118335	54	P1220BF	206
N-0003B	202	P100861	480	P1110P1	208	P118340	54	P1220C1	204
N-0006B	202	P100862	480	P111111	199	P118345	54	P1220P1	208
P1	514	P100871	480	P111501	198	P118350	54	P122222	199
P100003P	202	P100880	480	P111502	200	P118360	54	P123040	87
P100004P	202	P100881	480	P1115BF	206	P120000	201	P123060	87
P100005P	202	P100882	480	P1115C1	204	P120004	201	P123140	87
P100006P	202	P100890	480	P1115F1	203	P120005	201	P123160	87
P100008P	202	P100891	480	P1115F2	203	P120018	68	P123260	87
P100511	474	P100892	480	P1115P1	208	P120020	68	P124024	70
P100512	474	P100900	479	P1115P6	210	P120022	68	P124028	70
P100520	474	P100931	481	P112001	198	P120024	68	P124032	70
P100521	474	P100932	481	P112002	200	P120026	68	P124036	70
P100522	474	P100940	481	P1120BF	206	P120028	68	P124040	70
P100530	475	P100950	481	P1120C1	204	P120032	68	P125000	199
P100531	475	P100951	481	P1120P1	208	P120036	68	P125038	70
P100540	475	P100955	481	P112324	55	P120040	68	P1250BF	207
P100541	475	P100960	481	P112328	55	P1200BF	207	P1250C1	205
P100542	475	P100965	481	P112332	55	P1200C1	205	P127024	69
P100543	475	P103322	55	P112335	55	P1200P1	201	P127028	69
P100544	475	P104318	55	P112340	55	P1200P2	201	P127032	69
P100550	475	P104320	55	P112345	55	P1200P3	201	P127040	69
P100551	475	P104324	55	P112350	55	P1200P6	210	P128018	68
P100552	475	P106320	55	P112360	55	P120201	198	P128020	68
P100553	475	P106324	55	P113035	82	P120401	198	P128022	68
P100554	475	P109035	117	P113040	82	P120651	198	P128024	68
P100570	475	P109040	117	P113050	82	P120652	200	P128026	68
P100571	475	P109045	117	P113060	82	P1206BF	206	P128028	68
P100572	475	P109050	117	P113070	82	P1206C1	204	P128032	68
P100600	474	P110000	201	P114040	83	P1206F1	203	P128036	68
P100601	474	P110004	201	P114050	83	P1206F3	397	P128040	68
P100740	478	P110005	201	P114060	83	P1206F3A	397	P128124	69

ÍNDICE NUMÉRICO / NUMERICAL INDEX /
INDEX NUMÉRIQUE / NUMAMERISCHER INDEX

REF.	PAG.	REF.	PAG.	REF.	PAG.	REF.	PAG.	REF.	PAG.
P128128	69	P135124	77	P15001	295	P1600P1	201	P19115R	460
P128132	69	P135128	77	P15002	295	P1600P2	201	P19116	460
P128224	69	P135132	77	P150028	74	P1600P3	201	P19117	460
P128228	69	P135140	77	P15003	295	P1600P6	210	P19118	460
P128232	69	P135330	77	P15004	304	P160651	199	P19120	392
P128324	69	P135424	77	P15005	304	P1606BF	207	P19126	241
P128328	69	P136006	170	P15006	304	P1606C1	205	P19126F1	241
P128332	69	P136007	170	P15007	304	P1606P1	209	P192118	69
P128424	69	P136008	170	P15008	304	P161001	199	P192120	69
P128428	69	P139012	70	P15010	334	P161034	56	P192124	69
P128432	69	P140000	201	P150128	73	P161038	56	P192128	69
P128920	67	P140004	201	P15020	329	P1610BF	207	P192132	69
P128924	67	P1400BF	207	P15027	337	P1610C1	205	P192136	69
P128928	67	P1400C1	205	P15028	337	P1610P1	209	P192140	69
P128932	67	P1400P1	201	P15029	331	P161501	199	P195000	469
P130000	201	P1400P2	201	P15030	331	P1615BF	207	P200012	41
P130004	201	P1400P3	201	P15031	332	P1615C1	205	P200014	41
P1300BF	207	P140201	199	P15032	332	P1615P1	209	P200016	41
P1300C1	205	P140651	199	P15033	331	P1615P6	210	P200018	41
P1300P1	201	P1406BF	207	P15034	331	P162001	199	P200020	41
P1300P2	201	P1406C1	205	P15035	293	P1650BF	207	P200022	41
P1300P3	201	P1406P1	209	P15038	301	P166032	75	P200024	41
P1300P6	210	P141001	199	P15039	301	P169020	75	P200028	41
P130201	198	P141014	56	P15040	302	P169024	75	P200116	41
P130202	200	P141016	56	P15041	302	P169028	75	P200120	41
P130401	198	P141020	56	P15042	300	P169030	75	P200320	42
P130402	200	P141024	56	P15070	295	P170020	57	P200324	42
P130651	198	P141028	56	P15071	295	P170024	57	P20041	490
P130652	200	P141032	56	P15072	290	P170028	57	P20042	490
P1306BF	206	P141036	56	P15073	334	P171024	57	P20050	490
P1306C1	204	P141040	56	P15074	334	P171028	57	P20066	490
P1306P1	209	P1410BF	207	P15075	296	P173016	57	P20069	490
P131001	198	P1410C1	205	P15077	290	P190000	201	P20072	421
P131002	200	P1410P1	209	P15078	289	P1900BF	207	P201016	41
P131022	70	P14126	241	P15079	290	P1900C1	205	P201018	41
P131026	70	P14126F1	241	P15080	293	P1900P1	201	P201020	41
P1310BF	206	P141501	199	P15089	307	P1900P2	201	P201024	41
P1310C1	204	P1415BF	207	P15090	307	P1900P3	201	P201028	41
P1310P1	209	P1415C1	205	P15091	307	P19060	392	P201032	41
P131501	198	P1415P1	209	P15096	334	P190651	199	P20115	241
P131502	200	P142000	74	P15097	334	P1906BF	207	P20115F1	241
P1315BF	206	P142001	199	P151012	56	P1906C1	205	P202016	41
P1315C1	204	P142100	73	P151014	56	P1906P1	209	P202018	41
P1315P1	209	P145000	199	P151016	56	P19090	392	P202020	41
P1315P6	210	P1450BF	207	P151020	56	P19100	460	P202024	41
P132001	198	P1450C1	205	P151024	56	P191001	199	P202028	41
P132002	200	P148020	69	P151028	56	P19101	460	P202032	41
P132040	87	P148024	69	P151032	56	P19103	460	P203016	42
P132060	87	P148028	69	P15105	241	P19104	460	P203018	42
P1320C1	204	P148032	69	P15105F1	241	P19105	460	P203020	42
P1320P1	209	P149120	72	P152025	89	P19106	460	P203024	42
P132140	87	P149124	72	P152030	89	P19107	460	P204020	42
P132160	87	P149128	72	P152035	89	P1910BF	207	P204024	42
P132260	87	P149130	72	P153025	89	P1910C1	205	P204028	42
P132365	84	P149228	72	P153034	89	P1910P1	209	P204030	42
P132560	84	P149330	73	P153050	89	P19114A	460	P204032	42
P135000	199	P149520	74	P160000	201	P19114N	460	P204035	42
P1350BF	207	P149524	74	P160004	201	P19114R	460	P204040	42
P1350C1	205	P149528	74	P1600BF	207	P19115A	460	P205020	40
P135120	77	P15000	295	P1600C1	205	P19115N	460	P205024	40

ÍNDICE NUMÉRICO / NUMERICAL INDEX /
INDEX NUMÉRIQUE / NUMAMERISCHER INDEX

REF.	PAG.	REF.	PAG.	REF.	PAG.	REF.	PAG.	REF.	PAG.
P205028	40	P216018	40	P22012	371	P22111	372	P22202V	370
P205030	40	P216020	40	P22013	371	P22112	372	P22203	370
P205032	40	P216024	40	P22014	371	P22113	372	P22203A	370
P205035	40	P216028	40	P22015	371	P22114	372	P22203AM	370
P205040	40	P216030	40	P22016	371	P22115	372	P22203N	370
P205045	40	P216032	40	P22019	374	P22116	372	P22203R	370
P205050	40	P216035	40	P22020	374	P22117	373	P22203V	370
P205060	40	P216040	40	P22022	374	P22118	373	P22204	370
P209016	41	P216045	40	P22023	374	P22120	388	P22211	370
P209018	41	P216050	40	P22030	389	P22124	379	P22220	369
P209020	41	P216060	40	P22031	389	P22125	379	P22221	369
P209024	41	P217016	40	P22033	373	P22126	379	P22222	369
P209028	41	P217018	40	P22034	373	P22127	376	P22223	362
P209030	41	P217020	40	P22035	389	P22128	376	P22250	373
P209032	41	P217024	40	P22036	389	P22129	376	P22251	373
P209035	41	P217028	40	P22037	368	P22144	379	P22301	349
P209040	41	P217030	40	P22038	368	P22145	379	P22302	349
P209045	41	P217032	40	P22039	381	P22150	371	P22303	349
P209050	41	P217035	40	P22040	384	P22151	371	P223035	44
P209060	41	P217040	40	P22041	381	P22154	385	P22304	349
P21000	461	P217045	40	P22042	384	P22155	385	P223040	44
P21001	461	P217050	40	P22043	381	P22156	385	P22305	349
P21003	461	P217060	40	P22044	384	P22158	385	P22306	349
P21005	461	P218016	40	P22045	381	P22160	385	P22307	349
P21015	461	P218018	40	P22046	384	P22161	378	P22308	349
P21016	461	P218020	40	P22047	381	P22162	378	P22309	349
P21017	461	P218024	40	P22048	384	P22164	368	P22310	351
P21020	461	P218028	40	P22049	381	P22165	368	P22311	351
P210201	198	P218030	40	P22050	384	P22166	368	P22312	351
P210202	200	P218032	40	P22051	381	P22167	369	P22313	351
P21027	461	P218035	40	P22052	384	P22168	369	P22314	351
P21028	461	P218040	40	P22053	381	P22169	367	P22315	351
P210401	198	P218045	40	P22054	384	P22170	367	P22316	351
P210402	200	P218050	40	P22079	384	P22171	367	P22317	351
P210651	198	P218060	40	P22080	381	P22172	367	P22318	350
P210652	200	P22000	371	P22081	384	P22173	367	P22319	350
P211001	198	P22001	371	P22082	381	P22174	374	P22320	350
P211002	200	P220018	64	P220820	65	P22175	374	P22321	350
P21105	241	P22002	370	P220824	65	P22176	374	P22322	355
P21105F1	241	P220020	64	P220828	65	P22177	369	P22323	355
P211501	198	P220021	370	P22083	384	P22178	373	P22324	355
P211502	200	P220022	64	P220832	65	P22179	373	P22325	355
P212001	198	P220023	370	P22084	381	P22180	373	P22326	355
P212002	200	P220024	64	P22085	371	P22181	373	P22327	355
P213018	65	P220026	64	P22086	371	P22182	372	P22328	355
P213020	65	P220028	64	P22087	384	P22183	372	P22329	354
P213022	65	P22003	369	P22088	386	P22184	372	P22330	354
P213024	65	P220031	369	P22090	374	P22185	389	P22331	354
P213026	65	P220032	64	P22094	384	P22200	370	P22332	350
P213028	65	P220033	369	P22099	371	P22200A	370	P22333	354
P213032	65	P220036	64	P22100	369	P22200AM	370	P22334	354
P213036	65	P22004	371	P22101	369	P22200N	370	P22335	354
P213040	65	P220040	64	P22102	369	P22200R	370	P22336	353
P214016	41	P22005	371	P22103	368	P22200V	370	P22337	353
P214018	41	P22006	384	P22104	386	P22201	370	P22338	353
P214020	41	P22007	384	P22105	386	P22202	370	P22339	353
P214022	41	P22008	384	P22106	386	P22202A	370	P22340	353
P214024	41	P22009	381	P22108	386	P22202AM	370	P22341	353
P215000	199	P22010	381	P22109	386	P22202N	370	P22342	353
P216016	40	P22011	381	P22110	386	P22202R	370	P22343	353

ÍNDICE NUMÉRICO / NUMERICAL INDEX /
INDEX NUMÉRIQUE / NUMAMERISCHER INDEX

REF.	PAG.	REF.	PAG.	REF.	PAG.	REF.	PAG.	REF.	PAG.
P22344	352	P22691	378	P22838	361	P22950	364	P23825	387
P22345	352	P22692	378	P22839	361	P22960	364	P23830	387
P22346	352	P22695	379	P22844	361	P22971	364	P23835	387
P22347	352	P22696	379	P22845	361	P22972	364	P23836	387
P22348	352	P22697	379	P22850	358	P22973	367	P23840	387
P22349	366	P22698	379	P22851	358	P22974	367	P23841	387
P22350	366	P22700	357	P22852	358	P22975	367	P23842	388
P22351	366	P22701	357	P22860	380	P230000	201	P23843	388
P22352	366	P22702	357	P22861	380	P23003	507	P23844	388
P22353	366	P22703	357	P22862	380	P23004	507	P23845	388
P22354	365	P22704	357	P22863	380	P23008	507	P239036	71
P22355	365	P22705	357	P22864	380	P23009	507	P239136	71
P22356	365	P22710	357	P22865	380	P23015	507	P239236	66
P22357	365	P22711	357	P22866	380	P230201	198	P239336	66
P22358	365	P22712	357	P22867	380	P230202	200	P239436	71
P22359	366	P22720	360	P22868	380	P23030	383	P239536	71
P22360	366	P22725	360	P22869	380	P23031	383	P23990	375
P22361	379	P22726	360	P22870	380	P23032	383	P23991	375
P22362	379	P22727	360	P22871	380	P23033	383	P23992	375
P22363	379	P22728	360	P22872	380	P23034	383	P23993	375
P22364	374	P22729	360	P22873	380	P23036	383	P240040	43
P22365	374	P22740	356	P22874	380	P23037	383	P240050	43
P22370A	363	P22741	356	P22875	380	P23038	383	P240401	198
P22370G	363	P22742	356	P22876	380	P23039	383	P240651	198
P22370N	363	P22743	356	P22877	380	P23040	383	P241001	198
P22370R	363	P22744	356	P22878	380	P230401	198	P241040	43
P22371A	363	P22745	356	P22879	380	P230402	200	P241050	43
P22371G	363	P22746	356	P22880	380	P23042	383	P241501	198
P22371N	363	P22750	356	P22881	380	P23043	383	P242024	43
P22371R	363	P22751	356	P22882	380	P23044	383	P242028	43
P224023	44	P22752	356	P22883	380	P23045	383	P242032	43
P224026	44	P22755	356	P22884	352	P23046	383	P242035	43
P22501	369	P22756	356	P22884A	362	P230651	198	P243024	43
P22502	369	P22758	360	P22884B	362	P230652	200	P243028	43
P22600	377	P22759	360	P22884G	362	P231001	198	P243032	43
P22601	377	P22760	356	P22884N	362	P231002	200	P243035	43
P22602	377	P22770	357	P22884NE	362	P231501	198	P244020	44
P22603	377	P22772	357	P22884R	362	P231502	200	P244024	44
P22604	377	P22775	375	P22885	352	P232001	198	P244028	44
P22610B	377	P22778	375	P22886	352	P232002	200	P244032	44
P22610N	377	P22779	375	P22887	352	P234020	42	P244035	44
P22611B	377	P22780	359	P22888	348	P234024	42	P24407	485
P22611N	377	P22781	359	P22889	348	P23500	464	P24409	485
P22614B	377	P22782	359	P22890	386	P235000	199	P248028	44
P22614N	377	P22783	359	P22891	348	P23501	464	P248032	44
P22620	377	P22784	359	P22892	348	P23502	464	P248035	44
P22621	377	P22800	358	P22893	348	P23503	464	P248040	44
P22622	377	P22801	358	P22894	348	P23504	465	P248045	44
P22640N	378	P22802	358	P22895	349	P23505	465	P25000	493
P22641N	378	P22803	358	P22896	348	P23506	465	P25002	493
P22642N	378	P22815	358	P22897	348	P23507	465	P25020	493
P22650	376	P22816	358	P22898	348	P23508	465	P26000	145
P22651	376	P22817	358	P22899	348	P23509	465	P26001	145
P22652	376	P22823	358	P22901	364	P23800	387	P26100	500
P22660	377	P22824	358	P22902	364	P23800A	362	P270114	52
P22661	377	P22825	358	P22911	364	P23800G	362	P270116	52
P22662	377	P22830	361	P22912	364	P23800N	362	P270118	52
P22663	377	P22833	361	P22920	388	P23800R	362	P270620	52
P22664	377	P22834	361	P22930	388	P23810	387	P270624	52
P22690	378	P22835	361	P22940	364	P23824	387	P270628	52

ÍNDICE NUMÉRICO / NUMERICAL INDEX /
INDEX NUMÉRIQUE / NUMAMERISCHER INDEX

REF.	PAG.	REF.	PAG.	REF.	PAG.	REF.	PAG.	REF.	PAG.
P270716	52	P296615	468	P307040	151	P317440	448	P33622	455
P270720	52	P296630	468	P307045	151	P317445	448	P33623	455
P270724	52	P296715	468	P307050	151	P317450	448	P33624	455
P270728	52	P296730	468	P307060	151	P318005	84	P33625	455
P28202	473	P29680	467	P307070	151	P318040	86	P337030	509
P28252	473	P299020	47	P307125	151	P318060	86	P337060	509
P28302	473	P299024	47	P307130	151	P318100	499	P337090	509
P28303	473	P299028	47	P307140	151	P318211	84	P337150	509
P28403	473	P299030	47	P307150	151	P319000	499	P337200	509
P28501	473	P299032	47	P308030	117	P319100	499	P33801	456
P28502	473	P299035	47	P308035	117	P32083	242	P33802	456
P28503	473	P299040	47	P308040	117	P32083F1	242	P33803	456
P28504	473	P299045	47	P308045	117	P322101	114	P33804	456
P28505	473	P299050	47	P308050	117	P322102	114	P33805	456
P28506	473	P299060	47	P309040	82	P322103	114	P33806	456
P28600	472	P300024	117	P309050	82	P322104	114	P33807	456
P28610	472	P300030	117	P309060	82	P322201	114	P33808	456
P28620	472	P300325	117	P310000	497	P322202	114	P33809	456
P28621	472	P300335	117	P311002	496	P322203	114	P340000	224
P290120	47	P300340	117	P311004	497	P322204	114	P340010	103
P290124	47	P30084	241	P311006	496	P324013	115	P340020	103
P290128	47	P30084F1	241	P311020	497	P324016	115	P340030	103
P290130	47	P301108	96	P311071	496	P324019	115	P340040	103
P290132	47	P301109	96	P312000	497	P324022	115	P340050	103
P290135	47	P301110	96	P313025	118	P324025	115	P340060	103
P290140	47	P301112	96	P313030	118	P325008	115	P340070	103
P290145	47	P301114	96	P313126	118	P325010	115	P340080	103
P290150	47	P301116	96	P313132	118	P325012	115	P340090	103
P291120	47	P301118	96	P313500	118	P325015	115	P341000	453
P291124	47	P301165	96	P314110	97	P325018	115	P342000	453
P291128	47	P301206	96	P314112	97	P325020	115	P343000	453
P291130	47	P301208	96	P314210	97	P326000	496	P343400	105
P291132	47	P301210	96	P314212	97	P327000	497	P343600	105
P291135	47	P301212	96	P314300	97	P328020	113	P343700	105
P291140	47	P301214	96	P315010	97	P328023	113	P343800	105
P291145	47	P301216	96	P315012	97	P328600	113	P344000	453
P291150	47	P302108	97	P315015	97	P330035	498	P345000	453
P291160	47	P302110	97	P315017	97	P330050	498	P347020	116
P292120	47	P302112	97	P315020	97	P330070	498	P347024	116
P292124	47	P302114	97	P316025	153	P331039	148	P348008	115
P292128	47	P302116	97	P316030	153	P331044	148	P348010	115
P292130	47	P302118	97	P316035	153	P331050	148	P348012	115
P292132	47	P302120	97	P316040	153	P331056	148	P348015	115
P292135	47	P302210	97	P316045	153	P331059	148	P348018	115
P292140	47	P302212	97	P316050	153	P331066	148	P350230	160
P292145	47	P302214	97	P316125	153	P331070	148	P350235	160
P292150	47	P302216	97	P316130	153	P332010	148	P350330	160
P292160	47	P303016	116	P316135	153	P332095	148	P350335	160
P293132	47	P303018	116	P316140	153	P333010	485	P350426	160
P293135	47	P303020	116	P316145	153	P333020	485	P350430	160
P293140	47	P303022	116	P316150	153	P333035	485	P350435	160
P29600	469	P303024	116	P317025	448	P334050	122	P350440	160
P29610	469	P303026	116	P317030	448	P334100	122	P350530	160
P29620	469	P303200	116	P317035	448	P335002	510	P350535	160
P29630	469	P303265	96	P317040	448	P33601	454	P350630	160
P296415	468	P306035	151	P317045	448	P33602	454	P350635	160
P296430	468	P307020	151	P317050	448	P33603	454	P350730	160
P2965001	467	P307025	151	P317425	448	P33604	454	P350735	160
P296515	468	P307030	151	P317430	448	P33614	454	P351000	458
P296530	468	P307035	151	P317435	448	P33621	455	P352000	458

ÍNDICE NUMÉRICO / NUMERICAL INDEX /
INDEX NUMÉRIQUE / NUMAMERISCHER INDEX

REF.	PAG.	REF.	PAG.	REF.	PAG.	REF.	PAG.	REF.	PAG.
P353000	458	P374013	115	P399000	499	P490624N	49	P5091F1	236
P354025	153	P374015	115	P399400	501	P490624R	49	P5160	232
P354030	153	P374018	115	P399500	501	P490628A	49	P5160E1	234
P354035	153	P374020	115	P399600	501	P490628G	49	P5160E1F1	237
P354040	153	P374026	115	P41001	471	P490628N	49	P5160E2	234
P354045	153	P375010	112	P41002	471	P490628R	49	P5160E2F1	237
P354050	153	P375030	115	P41003	471	P490632A	49	P5160E3	234
P355007	170	P375035	115	P41004	470	P490632G	49	P5160E3F1	237
P355008	170	P375061	112	P44073	242	P490632N	49	P5160E4	234
P356016	152	P375070	112	P44073F1	242	P490632R	49	P5160E4F1	237
P356020	152	P375110	112	P454012	51	P490724A	49	P5160E5	234
P356024	152	P376037	98	P454014	51	P490724G	49	P5160E5F1	237
P356028	152	P376137	98	P454016	51	P490724N	49	P5160F1	236
P356032	152	P377037	98	P454018	51	P490724R	49	P5161	232
P357000	493	P377137	99	P456016	51	P490728A	49	P5161F1	236
P358024	106	P379065	439	P456020	51	P490728G	49	P5250	232
P358029	106	P379500	440	P456024	51	P490728N	49	P5250E1	234
P358040	106	P380000	111	P456028	51	P490728R	49	P5250E1F1	237
P358230	457	P381008	111	P457016	51	P490732A	49	P5250E2	234
P358231	457	P381010	111	P457020	51	P490732G	49	P5250E2F1	237
P358232	457	P38160250	342	P457024	51	P490732N	49	P5250E3	234
P358237	457	P382000	111	P457028	51	P490732R	49	P5250E3F1	237
P358241	106	P38250250	340	P458024	51	P490928A	49	P5250E4	234
P358242	106	P383000	111	P458028	51	P490928G	49	P5250E4F1	237
P358243	106	P384000	111	P459020	66	P490928N	49	P5250E5	234
P358244	106	P38420250	341	P459024	66	P490928R	49	P5250E5F1	237
P358245	106	P385020	111	P459028	66	P490932A	49	P5250F1	236
P358246	106	P385026	111	P460018	70	P490932G	49	P5251	232
P358247	106	P385030	111	P460020	70	P490932N	49	P5251F1	236
P358301	106	P385500	112	P460024	70	P490932R	49	P5360	233
P358302	106	P38550250	340	P460026	70	P5000	238	P5360E1	235
P358303	106	P386000	111	P460028	70	P5001	238	P5360E1F1	237
P358304	106	P387065	440	P460030	70	P5002	238	P5360E2	235
P358305	106	P387100	441	P460032	70	P5003	238	P5360E2F1	237
P358306	106	P387200	441	P490014A	49	P5004	238	P5360E3	235
P358307	106	P387500	439	P490014G	49	P5015	259	P5360E3F1	237
P358404	106	P388018	499	P490014N	49	P5017	259	P5360E4	235
P358407	106	P389000	459	P490014R	49	P5018	238	P5360E4F1	237
P359000	458	P390000	136	P490016A	49	P5019	238	P5360E5	235
P361000	451	P390100	136	P490016G	49	P501F1	229	P5360E5F1	237
P361100	452	P391000	113	P490016N	49	P501F2	229	P5360F1	236
P362000	451	P392065	96	P490016R	49	P501F3	229	P5361	233
P362100	452	P393080	153	P490220A	65	P501F4	229	P5361F1	236
P363000	451	P393100	153	P490220G	65	P501F5	229	P5490	233
P363100	452	P393125	153	P490220N	65	P501F6	229	P5490E1	235
P364000	451	P394008	98	P490220R	65	P5062	238	P5490E1F1	237
P364100	452	P394012	98	P490224A	65	P508015	332	P5490E2	235
P365000	451	P395038	99	P490224G	65	P5090	232	P5490E2F1	237
P365100	452	P397247	99	P490224N	65	P5090E1	234	P5490E3	235
P366000	451	P397347	99	P490224R	65	P5090E1F1	237	P5490E3F1	237
P367000	451	P398024	154	P490228A	65	P5090E2	234	P5490E4	235
P367100	452	P398035	154	P490228G	65	P5090E2F1	237	P5490E4F1	237
P36790250	341	P398042	154	P490228N	65	P5090E3	234	P5490E5	235
P368000	451	P398125	154	P490228R	65	P5090E3F1	237	P5490E5F1	237
P369000	451	P398135	154	P490620A	49	P5090E4	234	P5490F1	236
P369100	452	P398140	154	P490620G	49	P5090E4F1	237	P5491	233
P372200	441	P398225	154	P490620N	49	P5090E5	234	P5491F1	236
P373020	115	P398235	154	P490620R	49	P5090E5F1	237	P590001	394
P373024	115	P398240	154	P490624A	49	P5090F1	236	P590002	394
P373028	115	P398290	154	P490624G	49	P5091	232	P590003	394

ÍNDICE NUMÉRICO / NUMERICAL INDEX /
INDEX NUMÉRIQUE / NUMAMERISCHER INDEX

REF.	PAG.	REF.	PAG.	REF.	PAG.	REF.	PAG.	REF.	PAG.
P590004	394	P623003	485	P646105	511	P703020	164	P7080	270
P590005	394	P625000	488	P646200	511	P703024	164	P708008	165
P590006	394	P630010	486	P646300	511	P703028	164	P708022	165
P590007	363	P630020	486	P646301	511	P703032	164	P708024	165
P590008	393	P630030	486	P646310	511	P7031	268	P7081	270
P590009	393	P630040	486	P646400	510	P7032	268	P7082	270
P590010	393	P63052	242	P649050	510	P7033	268	P7083	270
P590011	393	P63052F1	242	P649100	510	P7034	268	P7084	270
P590012	393	P632001	486	P650000	488	P7035	268	P7085	270
P590110	395	P632002	486	P685004	441	P7036	268	P7086	270
P590120	395	P632003	486	P688045	331	P7037	268	P7087	270
P590130	395	P632004	486	P688065	289	P7038	268	P7088	270
P590240	395	P632005	486	P688085	296	P7039	268	P7089	270
P595100	433	P632006	486	P688087	296	P7040	268	P7090	270
P595110	433	P632007	486	P688130	330	P704024	163	P709035	163
P595111	433	P632008	486	P688133	330	P704030	163	P7091	270
P595120	433	P632009	486	P688134	330	P7041	268	P7092	270
P595121	433	P632010	486	P688250	332	P7042	268	P7093	270
P595130	433	P632011	486	P688251	332	P7043	268	P7094	272
P595131	433	P632012	486	P688260	332	P7044	268	P7095	272
P595200	433	P632013	486	P688261	332	P7045	268	P7096	272
P595300	433	P632014	486	P688265	331	P7046	268	P7097	272
P596110	432	P632015	486	P688266	331	P7047	270	P7098	272
P596111	432	P632016	486	P7000	268	P7048	270	P7099	272
P596120	432	P632017	486	P7001	268	P7049	270	P7100	272
P596121	432	P632018	486	P7002	268	P7050	270	P710020	164
P596130	432	P632019	486	P7003	268	P705024	91	P710024	164
P596131	432	P632020	486	P7004	268	P705028	91	P710028	164
P597110	434	P632021	486	P7004R	274	P705032	91	P7101	272
P597120	434	P632022	486	P7005	268	P7051	270	P7102	272
P597130	434	P632023	486	P7005R	274	P7052	270	P710205	331
P597140	435	P632024	486	P7006	268	P7053	270	P710206	331
P597150	435	P632025	486	P7006R	274	P7054	270	P7103	272
P597160	435	P632026	486	P7007	268	P7055	270	P7104	272
P597170	434	P632027	486	P7008	268	P7056	270	P7105	272
P598700	394	P632028	486	P7009	268	P7057	270	P7106	272
P598800	394	P632029	486	P7010	268	P7058	270	P7107	272
P603012	144	P632030	486	P7011	268	P7059	270	P7108	272
P603015	144	P633000	486	P7012	268	P7060	270	P7109	272
P604001	144	P633002	486	P7013	268	P706039	163	P7110	272
P604002	144	P633003	486	P7014	268	P7061	270	P711010	164
P604500	144	P634000	486	P7015	268	P7062	270	P711012	164
P605000	458	P635000	490	P7016	268	P7063	270	P711020	164
P606000	458	P636000	490	P7017	268	P7064	270	P711024	164
P607000	92	P637000	490	P7018	268	P7065	270	P711028	164
P607100	92	P637100	490	P7019	268	P7066	270	P711032	164
P609010	142	P638000	488	P7020	268	P7067	270	P7111	272
P609200	142	P639000	488	P702026	163	P7068	270	P7112	272
P609705	142	P640000	246	P702028	163	P7069	270	P7113	272
P610000	136	P641100	246	P7021	268	P7070	270	P7114	272
P611000	142	P642000	246	P7022	268	P707039	163	P7115	272
P611001	109	P643000	246	P702230	163	P7071	270	P7116	272
P615000	459	P644100	511	P7023	268	P7072	270	P7117	272
P616000	499	P644175	511	P7024	268	P7073	270	P7118	272
P617017	458	P644200	511	P7025	268	P7074	270	P7119	272
P618000	459	P644240	511	P7026	268	P7075	270	P7120	272
P619000	503	P644275	511	P7027	268	P7076	270	P712022	165
P619002	503	P646000	495	P7028	268	P7077	270	P7121	272
P620001	109	P646100	511	P7029	268	P7078	270	P7122	272
P621000	109	P646103	511	P7030	268	P7079	270	P7123	272

ÍNDICE NUMÉRICO / NUMERICAL INDEX /
INDEX NUMÉRIQUE / NUMAMERISCHER INDEX

REF.	PAG.	REF.	PAG.	REF.	PAG.	REF.	PAG.	REF.	PAG.
P7124	272	P7177	268	P7221	270	P7279	272	P7337	271
P7125	272	P7178	268	P7222	270	P7280	272	P7338	271
P7126	272	P7179	268	P7223	270	P7281	272	P7339	271
P7127	272	P7180	268	P7224	270	P7282	269	P7340	271
P7128	272	P718006	166	P7225	270	P7283	269	P7341	271
P7129	272	P718008	166	P7226	270	P7284	269	P7342	271
P7130	272	P718010	166	P7227	270	P7285	269	P7343	271
P713075	165	P718011	166	P7228	270	P7286	269	P7344	271
P7131	272	P7181	268	P7229	270	P7287	269	P7345	271
P7132	272	P7182	268	P7230	270	P7288	269	P7346	271
P7133	272	P7183	268	P723024	164	P7289	269	P7347	271
P7134	272	P7184	268	P723028	164	P7290	269	P7348	271
P7135	272	P7185	268	P7231	270	P7291	269	P7349	271
P7136	272	P7186	268	P7232	270	P7292	269	P7350	271
P7137	272	P7187	268	P7233	270	P7293	269	P7351	271
P7138	272	P7188	270	P7234	270	P7294	269	P7352	271
P7139	272	P7189	270	P7235	272	P7295	269	P7353	271
P7140	272	P7190	270	P7236	272	P7296	269	P7354	271
P7141	268	P7191	270	P7237	272	P7297	269	P7355	271
P7142	268	P7192	270	P7238	272	P7298	269	P7356	271
P7143	268	P7193	270	P7239	272	P7299	269	P7357	271
P7144	268	P7194	270	P7240	272	P7300	269	P7358	271
P7145	268	P7195	270	P7241	272	P7301	269	P7359	271
P7145R	274	P7196	270	P7242	272	P7302	269	P7360	271
P7146	268	P7197	270	P7243	272	P7303	269	P736030	91
P7146R	274	P7198	270	P7244	272	P7304	269	P736034	91
P7147	268	P7199	270	P7245	272	P7305	269	P7361	271
P7147R	274	P7200	270	P7246	272	P7306	269	P7362	271
P7148	268	P720005	166	P7247	272	P7307	269	P7363	271
P7149	268	P720006	166	P7248	272	P7308	269	P7364	271
P7150	268	P720007	166	P7249	272	P7309	269	P7365	271
P715006	165	P720008	166	P7250	272	P7310	269	P7366	271
P7151	268	P720010	166	P7251	272	P7311	269	P7367	271
P7152	268	P720012	166	P7252	272	P7312	269	P7368	271
P7153	268	P7201	270	P7253	272	P7313	269	P7369	271
P7154	268	P7202	270	P7254	272	P7314	269	P7370	271
P7155	268	P7203	270	P7255	272	P7315	269	P7371	271
P7156	268	P7204	270	P7256	272	P7316	269	P7372	271
P7157	268	P7205	270	P7257	272	P7317	269	P7373	271
P7158	268	P7206	270	P7258	272	P7318	269	P7374	271
P7159	268	P7207	270	P7259	272	P7319	269	P7375	271
P7160	268	P7208	270	P7260	272	P7320	269	P7376	273
P7161	268	P7209	270	P7261	272	P732000	167	P7377	273
P7162	268	P7210	270	P7262	272	P7321	269	P7378	273
P7163	268	P721005	166	P7263	272	P7322	269	P7379	273
P7164	268	P721006	166	P7264	272	P7323	269	P7380	273
P7165	268	P721007	166	P7265	272	P7324	269	P7381	273
P7166	268	P721008	166	P7266	272	P7325	269	P7382	273
P7167	268	P721010	166	P7267	272	P7326	269	P7383	273
P7168	268	P7211	270	P7268	272	P7327	269	P7384	273
P7169	268	P7212	270	P7269	272	P7328	269	P7385	273
P7170	268	P7213	270	P7270	272	P7329	271	P7386	273
P717008	166	P7214	270	P7271	272	P7330	271	P7387	273
P717010	166	P7215	270	P7272	272	P733000	167	P7388	273
P7171	268	P7216	270	P7273	272	P7331	271	P7389	273
P7172	268	P7217	270	P7274	272	P7332	271	P7390	273
P7173	268	P7218	270	P7275	272	P7333	271	P7391	273
P7174	268	P7219	270	P7276	272	P7334	271	P7392	273
P7175	268	P7220	270	P7277	272	P7335	271	P7393	273
P7176	268	P722000	166	P7278	272	P7336	271	P7394	273

**ÍNDICE NUMÉRICO / NUMERICAL INDEX /
INDEX NUMÉRIQUE / NUMAMERISCHER INDEX**

REF.	PAG.	REF.	PAG.	REF.	PAG.	REF.	PAG.	REF.	PAG.
P7395	273	P7455	269	P7515	271	P7576	277	P7646	276
P7396	273	P7456	269	P7516	271	P7577	277	P7647	276
P7397	273	P7457	269	P7517	273	P7578	277	P765020	169
P7398	273	P7458	269	P7518	273	P7579	277	P765024	169
P7399	273	P7459	269	P7519	273	P7580	277	P768006	169
P7400	273	P7460	269	P7520	273	P7581	277	P768008	169
P7401	273	P7461	269	P7521	273	P7582	277	P769008	169
P7402	273	P7462	269	P7522	273	P7583	277	P769010	169
P7403	273	P7463	269	P7523	273	P7584	277	P769018	169
P7404	273	P7464	269	P7524	273	P7585	276	P769020	169
P7405	273	P7465	269	P7525	273	P7586	276	P769022	169
P7406	273	P7466	269	P7526	273	P7587	276	P771025	169
P7407	273	P7467	269	P7527	273	P7588	276	P777540	86
P7408	273	P7468	269	P7528	273	P7589	276	P777548	86
P7409	273	P7469	269	P7529	273	P7590	276	P777560	86
P7410	273	P7470	271	P7530	273	P7591	276	P778040	86
P7411	273	P7471	271	P7531	273	P7592	276	P778048	86
P7412	273	P7472	271	P7532	273	P7593	276	P778060	86
P7413	273	P7473	271	P7533	273	P7594	276	P779017	86
P7414	273	P7474	271	P7534	273	P7595	276	P779021	86
P7415	273	P7475	271	P7535	273	P7596	276	P779026	86
P7416	273	P7476	271	P7536	273	P7597	276	P779060	86
P7417	273	P7477	271	P7537	273	P7598	276	P780006	168
P7418	273	P7478	271	P7538	273	P7599	276	P780008	168
P7419	273	P7479	271	P7539	273	P7603	274	P780010	168
P7420	273	P7480	271	P7540	273	P7604	274	P781006	168
P7421	273	P7481	271	P7541	273	P7605	274	P781008	168
P7422	273	P7482	271	P7542	273	P7606	274	P781010	168
P7423	269	P7483	271	P7543	273	P7607	274	P782008	168
P7424	269	P7484	271	P7544	273	P7608	274	P782010	168
P7425	269	P7485	271	P7545	273	P7609	274	P782012	168
P7426	269	P7486	271	P7546	273	P7610	274	P782014	168
P7427	269	P7487	271	P7547	273	P7611	274	P782016	168
P7428	269	P7488	271	P7548	273	P7612	274	P782018	168
P7429	269	P7489	271	P7549	273	P7613	274	P782020	168
P7430	269	P7490	271	P7550	273	P7614	274	P782022	168
P7431	269	P7491	271	P7551	273	P7615	274	P782024	168
P7432	269	P7492	271	P7552	273	P7616	274	P782026	168
P7433	269	P7493	271	P7553	273	P7617	274	P782028	168
P7434	269	P7494	271	P7554	273	P7618	274	P782075	168
P7435	269	P7495	271	P7555	273	P7628	275	P783006	168
P7436	269	P7496	271	P7556	273	P7629	275	P783008	168
P7437	269	P7497	271	P7557	273	P7630	275	P783010	168
P7438	269	P7498	271	P7558	273	P7631	275	P783012	168
P7439	269	P7499	271	P7559	273	P7632	275	P783014	168
P7440	269	P7500	271	P7560	273	P7633	275	P783016	168
P7441	269	P7501	271	P7561	273	P7634	275	P783018	168
P7442	269	P7502	271	P7562	273	P7635	275	P783020	168
P7443	269	P7503	271	P7563	273	P7636	275	P783022	168
P7444	269	P7504	271	P7565	277	P7637	275	P783024	168
P7445	269	P7505	271	P7566	277	P7638	275	P783026	168
P7446	269	P7506	271	P7567	277	P7639	275	P783028	168
P7447	269	P7507	271	P7568	277	P7640	275	P783030	168
P7448	269	P7508	271	P7569	277	P764008	152	P784020	170
P7449	269	P7509	271	P7570	277	P764010	152	P784025	170
P7450	269	P7510	271	P7571	277	P764012	152	P784030	170
P7451	269	P7511	271	P7572	277	P7641	275	P784035	170
P7452	269	P7512	271	P7573	277	P7642	275	P784040	170
P7453	269	P7513	271	P7574	277	P7643	275	P785006	168
P7454	269	P7514	271	P7575	277	P76430	275	P785008	168

ÍNDICE NUMÉRICO / NUMERICAL INDEX /
INDEX NUMÉRIQUE / NUMAMERISCHER INDEX

REF.	PAG.	REF.	PAG.	REF.	PAG.	REF.	PAG.	REF.	PAG.
P785010	168	P80590	259	P815012	174	P850022	178	P85140R	25
P788025	170	P80610	258	P815015	174	P850023	178	P85140SP	29
P788050	170	P80620	258	P816011	173	P850024	178	P85140SS	25
P789025	170	P80630	258	P816015	173	P850025	178	P853004	176
P789050	170	P80640	258	P817005	173	P850026	178	P853006	176
P796000	167	P80670	251	P817006	173	P850027	178	P853008	176
P796100	167	P80680	250	P817008	173	P850028	178	P853010	176
P798040	172	P80700	225	P818000	122	P850031	178	P853012	176
P798055	172	P807000	155	P820000	174	P850033	178	P853014	176
P798056	172	P80710	225	P821000	174	P850124	179	P854006	176
P798065	172	P80720	225	P822000	175	P850128	179	P854008	176
P800030	171	P80730	225	P823000	175	P850222	179	P854010	176
P800035	171	P80740	257	P824000	175	P850424	179	P854012	176
P800040	171	P80750	259	P830001	161	P850426	179	P854014	176
P800045	171	P80760	259	P830002	161	P850501215	26	P854016	176
P800050	171	P80770	259	P830003	161	P850501230	26	P855000	176
P800055	171	P80780	258	P830004	161	P850501315	26	P856000	176
P800060	171	P80810	255	P830005	161	P850501330	26	P857000	176
P800065	171	P80811	255	P833001	92	P850502815	26	P859101	184
P800070	171	P80813	255	P833002	92	P850502830	26	P859102	184
P801040	156	P80814	255	P833003	92	P85050B	24	P859103	184
P801048	156	P80840	254	P834000	395	P85050R	24	P859104	184
P802000	156	P80850	254	P835000	395	P85050SS	24	P859105	184
P80210	430	P80870	254	P836110	157	P850528	179	P859106	187
P80216	430	P80880	254	P836120	157	P850614	179	P859107	187
P80219	430	P80900	246	P836147	157	P850901415	27	P859109	184
P80220	430	P80910	256	P836200	157	P850901430	27	P859110	184
P80240	247	P80940	250	P836215	157	P850901615	27	P859111	184
P80250	247	P80941	250	P837003	160	P850901630	27	P859113	183
P80260	247	P80950	256	P837005	160	P850901815	27	P859114	186
P80270	247	P80951	256	P837007	160	P850901830	27	P859115	183
P80280	247	P80960	249	P837300	160	P85090B	24	P859116	188
P80282	248	P80961	249	P839000	155	P85090MP	30	P859117	187
P80290	247	P80970	252	P840000	155	P85090MPR	30	P859119	189
P80300	247	P81000	336	P842000	155	P85090MT	30	P859120	189
P803000	156	P810004	173	P845040	156	P85090MTR	30	P859122	185
P80310	247	P810006	173	P845050	156	P85090R	24	P859123	185
P80320	247	P810008	173	P845060	156	P85090SP	29	P859124	185
P80330	249	P810010	173	P845075	156	P85090SS	24	P859125	186
P80340	249	P810012	173	P845110	156	P851001	28	P859126	186
P80350	249	P810014	173	P845138	156	P851002	28	P859129	188
P80360	249	P81010	336	P845155	156	P851003	28	P859130	186
P80374	250	P81020	336	P846025	144	P851004	31	P859132	183
P80380	257	P811004	173	P846050	144	P851005	31	P859134	183
P80390	257	P811006	173	P846100	144	P851006	31	P859135	183
P804000	156	P811008	173	P846200	144	P851007	31	P859139	183
P80430	251	P811010	173	P846300	144	P851040	171	P859141	183
P80440	253	P811012	173	P848008	157	P851046	171	P859142	183
P80460	254	P811014	173	P848014	157	P851050	171	P859143	184
P80470	252	P811016	173	P849000	172	P851401415	27	P859144	184
P80480	253	P812003	173	P850001	178	P851401430	27	P859150	184
P80500	254	P812005	173	P850002	178	P851401615	27	P859151	184
P805000	155	P812007	173	P850003	178	P851401630	27	P859152	185
P80510	253	P812009	173	P850004	178	P851401815	27	P859153	185
P80520	252	P812011	173	P850005	178	P851401830	27	P859154	185
P80540	258	P813016	173	P850006	178	P85140B	25	P859155	185
P80550	258	P813020	173	P850007	178	P85140MP	30	P859156	185
P80560	258	P814000	174	P850012	178	P85140MPR	30	P859157	185
P80570	258	P815006	174	P850017	178	P85140MT	30	P859158	185
P80580	259	P815009	174	P850018	178	P85140MTR	30	P859159	185

ÍNDICE NUMÉRICO / NUMERICAL INDEX /
INDEX NUMÉRIQUE / NUMAMERISCHER INDEX

REF.	PAG.	REF.	PAG.	REF.	PAG.	REF.	PAG.	REF.	PAG.
P859167	186	P873060	122	P902000	459	P905504	414	P911803	139
P859171	186	P873090	122	P903001	442	P905506	414	P911804	139
P859172	186	P874000	487	P903002	442	P905508	415	P911805	139
P859184	186	P880035	506	P904113	424	P905516	414	P911806	139
P859185	186	P880050	506	P904120	424	P905518	415	P911808	139
P859186	186	P881100	506	P904140	425	P907024	449	P911901	140
P859189	186	P882015	506	P904142	426	P907026	449	P911902	140
P859190	186	P882035	506	P904145	425	P908000	148	P911903	140
P859191	187	P882100	506	P904146	427	P908001	148	P911904	140
P859192	187	P885025	506	P904155	421	P908002	148	P911905	140
P859195	187	P885040	506	P904160	425	P908003	148	P911906	140
P859196	187	P885060	506	P904165	424	P908004	148	P911908	140
P859197	187	P886035	506	P904200	426	P90813	431	P912001	139
P859198	187	P887015	506	P904300	395	P908132	431	P913000	140
P859200	188	P887025	506	P904350	419	P90814	431	P913501	140
P859201	188	P887060	506	P904360	419	P908142	431	P913601	140
P859202	189	P887100	506	P904400	426	P909111	88	P913701	140
P859203	189	P890025	505	P904500	426	P909121	88	P913901	140
P859204	189	P890035	505	P904600	422	P909211	88	P914080	149
P859205	189	P890060	505	P904610	422	P909221	88	P914120	149
P859206	187	P891035	505	P904612	422	P909340	88	P914150	149
P859207	187	P891060	505	P904650	422	P909360	88	P915080	149
P859210	188	P891100	505	P904652	422	P909460	88	P916000	149
P859211	188	P892015	505	P904660	422	P909559	162	P916120	149
P859212	188	P892015B	504	P904680	422	P910008	330	P917080	149
P859219	185	P892015N	504	P904682	422	P911201	139	P919000	222
P859900	180	P892015R	504	P904711	420	P911202	139	P919001	222
P859901	180	P892025	505	P904720	421	P911301	139	P919002	222
P859902	180	P892035	505	P904721	427	P911302	139	P919003	222
P859903	180	P892035B	504	P904725	421	P911303	139	P920001	223
P859904	180	P892035N	504	P904740	420	P911304	139	P920002	223
P859905	180	P892035R	504	P904760	420	P911305	139	P920003	223
P859906	181	P892060	505	P904780	420	P911306	139	P921001	223
P859907	181	P892060B	504	P904790	418	P911401	139	P922000	223
P859908	181	P892060N	504	P904800	418	P911402	139	P922100	223
P859909	181	P892060R	504	P904801	427	P911403	139	P923000	223
P859910	181	P892100	505	P904804	427	P911404	139	P923001	223
P859911	181	P892150	505	P904806	427	P911405	139	P924001	223
P861045	224	P892200	505	P904807	427	P911406	139	P924002	223
P861053	224	P893025	505	P904808	418	P911407	140	P924002A	223
P862100	487	P893035	505	P904809	427	P911408	139	P924002R	223
P863000	487	P894003	509	P904810	421	P911501	140	P924002V	223
P867030	386	P894004	509	P904820	421	P911502	140	P925001	256
P867060	386	P894005	509	P904850	421	P911503	140	P925002	256
P867090	386	P895006	509	P90490	429	P911504	140	P926002	483
P867120	386	P895010	509	P90492	429	P911505	140	P926003	483
P868001	119	P895015	509	P90493	429	P911506	140	P926004	483
P868002	119	P895020	509	P904937	423	P911507	140	P926005	483
P868003	119	P896001	508	P904950	423	P911508	140	P926006	483
P868004	119	P896002	508	P904975	423	P911601	140	P926007	483
P868005	119	P896003	507	P904980	423	P911602	140	P926008	483
P868006	119	P896008	507	P904990	423	P911603	140	P926009	483
P868007	119	P897500	439	P905015	121	P911604	140	P926010	483
P868008	119	P898001	508	P905200	417	P911605	140	P926011	483
P868009	119	P898002	508	P905300	416	P911606	140	P926012	483
P870000	121	P899200	443	P905310	416	P911607	140	P926051	482
P871000	121	P899300	443	P905320	417	P911608	140	P926052	482
P872000	112	P900000	225	P905340	417	P911701	139	P926053	482
P872500	157	P901014	140	P905400	415	P911801	139	P926300	468
P873045	122	P901018	140	P905410	416	P911802	139	P926400	468

ÍNDICE NUMÉRICO / NUMERICAL INDEX /
INDEX NUMÉRIQUE / NUMAMERISCHER INDEX

REF.	PAG.	REF.	PAG.	REF.	PAG.	REF.	PAG.	REF.	PAG.
P926500	468	P954020	118	P980050	143	P997016	78	TR22	242
P926600	468	P954025	118	P980200	142	P997028	78	TR23	242
P927000	449	P955010	98	P980400	144	P997032	78	TR30	242
P928000	449	P955012	98	P981400	143	P997036	78	TR33	238
P928001	449	P955015	98	P981500	143	P997040	78	TRA	238
P929025	91	P955017	98	P981600	143	P998035	79	TRG	232
P929028	91	P955020	98	P981650	143	P998050	79	TRH	233
P929030	91	P956035	503	P983000	502	P998070	79	TRJ	232
P929036	91	P956040	503	P984100	502	P999000	79	TRM	233
P929040	91	P956135	503	P984500	502	PLC-1	516	VCBL100	219
P937000	133	P956140	503	P985000	502	PLC-2	516	VCBM100	219
P938000	136	P958010	118	P988100	495	PLC-3	516	VDBBM300	221
P940000	122	P958012	118	P988200	495	RE850000	25	VDBBM50002	221
P940090	122	P958014	118	P988300	495	RE8505004	29	VPB116	217
P940120	122	P958016	118	P988400	494	RE8509007	29	VPB118	217
P941013	98	P958018	118	P988500	494	RE851008	31	VTB300	221
P941015	98	P959025	153	P988600	494	RE8514007	29	VTB50002	221
P941018	98	P959030	153	P988700	494	RE937001	133	VTBWR-1	221
P941020	98	P959035	153	P988800	495	RE937002	133	WBW300XCE	296
P941022	98	P959040	153	P988900	495	RE937003	133	WCT708E	302
P941024	98	P959045	153	P990000	495	RE940001	122	WICSP180E	297
P941028	98	P959050	153	P9900000	342	RE964100	136	WKS800E	319
P942000	121	P960225	154	P99001	215	RE964200	136	WSB2W	310
P943000	121	P960230	154	P99020	216	RE975001	129	WSB33XE	310
P944000	122	P960235	154	P99021	216	RE975002	129	WSB40E	310
P94500250	342	P962002	440	P99030	218	RE975901	135	WSB50ST	309
P945037	118	P962003	440	P99031	218	RSCL-4	516	WSB55ST	309
P945050	118	P963025	91	P992040	169	S1	514	WSB60ST	309
P945051	118	P963030	91	P992045	169	SAC-SQ5-06	260	WSB65ST	309
P946001	120	P963035	91	P992050	169	SAVC	261	WSB70ST	309
P946002	120	P963040	91	P994020	78	SO2-23010.5	299	WSBPPCE	309
P946003	120	P964001	136	P994022	78	SO2-23014.5	299	WW180XCE	297
P946004	120	P967001	484	P994024	78	T3660	443	WW200E	297
P947302	145	P967002	484	P994026	78	T7206	148	WWCM180E	297
P947303	145	P967003	484	P994030	78	TBB145E	315	XMIX0702	306
P947400	145	P967004	484	P994032	78	TBB160E	315	XMIX0703	306
P947600	145	P967005	484	P994034	78	TR11	232	XMIX0704	306
P947700	145	P967006	484	P994036	78	TR11G	234	XMIX0705	306
P948066	92	P967007	484	P994038	78	TR11GG	234		
P948090	92	P967008	484	P994040	78	TR11GGG	234		
P948132	92	P967009	484	P994042	78	TR11GGGG	234		
P949025	91	P968000	29	P994046	78	TR11GGGGG	234		
P949030	91	P968125	487	P994050	78	TR12	233		
P949035	91	P968130	487	P994055	78	TR12H	235		
P949040	91	P968135	29	P994065	78	TR12HH	235		
P950000	334	P969000	487	P994080	78	TR12HHH	235		
P951010	152	P970000	116	P994090	78	TR12HHHH	235		
P951015	152	P972053	92	P995010	78	TR12HHHHH	235		
P951019	152	P972060	92	P995016	78	TR13	233		
P951024	152	P974000	497	P995020	78	TR13M	235		
P952001	152	P975000	129	P995026	78	TR13MM	235		
P952002	152	P975500	137	P995030	78	TR13MMM	235		
P952003	152	P975600	137	P995034	78	TR13MMMM	235		
P953001	152	P975900	135	P995036	78	TR18	232		
P953002	152	P976200	496	P995038	78	TR18J	234		
P953003	152	P976300	496	P995040	78	TR18JJ	234		
P953004	152	P979000	159	P995042	78	TR18JJJ	234		
P953005	152	P979100	159	P995050	78	TR18JJJJ	234		
P954013	118	P979200	159	P995060	78	TR18JJJJJ	234		
P954015	118	P980000	143	P997014	78	TR21	242		

1. DISPOSICIONES LEGALES

Todas las ventas realizadas por PUJADAS – Una compañía del grupo Vollrath (en adelante, “el vendedor”) están sujetas a los presentes términos y condiciones, y están expresamente condicionadas por la aceptación de los presentes términos y condiciones. Ningún otro término o condición adicional o diferente será vinculante para el vendedor a menos que se acuerde lo contrario específicamente por escrito. Por el presente el vendedor no acepta otros términos adicionales o diferentes y notifica al comprador que no está dispuesto a vender en virtud de términos diferentes de los presentes términos y condiciones. **Cada contrato de venta, incluyendo los presentes términos y condiciones, constituirá el acuerdo indivisible entre el vendedor y el comprador, y se regirá, interpretará y entenderá según las leyes de España, sin remisión a los Principios sobre Conflictos de Leyes. Los derechos y las obligaciones de las partes en virtud del presente no se regirán por la Convención de las Naciones Unidas sobre los Contratos de Compraventa Internacional de Mercaderías de 1980; y por el presente ambas partes se someten expresamente a la jurisdicción de los tribunales de Barcelona (España), para cualquier proceso judicial que surja de las presentes condiciones generales de venta o relacionado con estas.** No existe ninguna condición que afecte al acuerdo de las partes que no esté expresada en los presentes términos y condiciones.

2. IMPUESTOS Y OTROS CARGOS

Los impuestos del fabricante, impuesto por ocupación, impuesto por el uso, impuesto sobre las ventas, impuesto sobre consumos específicos, impuesto sobre el valor añadido, tasas, tarifas de personalización, inspección o prueba, o cualquier otro impuesto, tasa, interés o cargo de cualquier naturaleza impuesto por una autoridad gubernamental, en virtud de la transacción entre el comprador y el vendedor serán pagados por el comprador, además de los precios cotizados o facturados. Si el vendedor debiera pagar dichos impuestos u otros cargos, el comprador deberá reembolsarlos al vendedor.

3. ENTREGA Y FLETE

Todos los productos se entregarán bajo FCA punto de origen (Incoterms 2010). Con la excepción de lo establecido a continuación, los pedidos realizados desde la zona de la Península Ibérica y las Islas Baleares con un valor superior a 500 € (1.400 € en las Islas Canarias) con envío a un sitio se enviarán PREPAGADOS por el vendedor. Los pedidos con un valor inferior a 500 € (Base Imponible) se grabarán con un cargo por flete de 20 € (55 € en las Islas Canarias). Para destinos finales fuera de España, todos los productos estarán sujetos a FCA muelle de carga del vendedor (según la definición de este último en Incoterms 2010). La entrega de los productos al transportista se considerará entrega al comprador; e independientemente de los términos de envío o el pago del flete, el comprador asumirá todos los riesgos por pérdida o daño durante el transporte. El vendedor se reserva el derecho a hacer la entrega en múltiples envíos, a menos que se estipule lo contrario expresamente en el presente; dichos envíos se facturarán por separado y se pagarán en la fecha que indica cada factura, independientemente de las entregas posteriores. El vendedor se reserva los derechos de propiedad de todos los materiales enviados hasta el pago completo de estos.

a. Gestión por pedido mínimo

Se aplicará un cargo de 6 € por la gestión de pedidos inferiores a 100 € NETOS. El vendedor se reserva el derecho a no aceptar pedidos de envío directo para los mismos productos a uno o múltiples sitios.

b. Cantidad

Los materiales se enviarán con el embalaje completo que contenga la cantidad indicada en nuestras tarifas.

c. Utensilios de cocina a medida

Los pedidos de utensilios de cocina a medida se ejecutan con entregas parciales/sobreenvíos, sin que la diferencia suponga un 10% más o menos de la cantidad original pedida.

d. Pedidos Urgentes para todo territorio nacional, incluyendo islas Baleares y Canarias

1. Pedido inferiores a 5 referencias se les aplicará un cargo de 10 €
2. Pedidos inferiores a 10 referencias se les aplicará un cargo de 15 €
3. Pedidos inferiores a 15 referencias se les aplicará un cargo de 20 €
4. Pedidos inferiores a 25 referencias se les aplicará un cargo de 35 €

El envío será por “Transporte Urgente” con compromiso de entrega en 24 horas, a excepción de las Islas Canarias. En estos casos, el transporte será a cargo del cliente.

4. RECLAMACIONES, RETRASOS Y FUERZA MAYOR

No se aceptarán bajo ninguna circunstancia reclamaciones relativas al estado de la mercancía o a errores de envío tras 15 días laborables desde la recepción de esta.

Las reclamaciones por falta de materiales u otros errores en la entrega deben efectuarse por escrito ante el vendedor en el plazo de 15 días laborables tras la recepción del envío; y el hecho de no notificar dicha reclamación supone la aceptación absoluta y la renuncia a cualquier reclamación por parte del comprador. **Las reclamaciones por pérdidas o daños en los productos durante el transporte deben efectuarse ante el transportista y no ante el vendedor. NUESTRA RESPONSABILIDAD POR EL ENVÍO FINALIZA CON LA ACEPTACIÓN DE ESTE POR PARTE DE LOS TRANSPORTISTAS.**

Todas las fechas de entrega son aproximadas. El retraso en la entrega de cualquier envío no exime al comprador de su obligación de aceptar los envíos restantes. Además, el vendedor no será responsable por las pérdidas o los daños que resulten de los retrasos o de la falta de entrega por cualquier causa fuera del control razonable del vendedor, incluyendo sin limitación fuerza mayor, actos del comprador, embargo u otro acto, norma o petición gubernamental, incendio, accidente, huelga, parones, guerra, acto de terrorismo, disturbios, retraso en el transporte o incapacidad para conseguir la mano de obra, los materiales o las instalaciones de producción necesarios. En caso de algún retraso de este tipo, la fecha de entrega se ampliará durante un plazo igual al tiempo perdido debido al retraso. El único remedio del comprador por otros retrasos y por la incapacidad del vendedor de efectuar la entrega por cualquier motivo será la rescisión de su contrato de compra.

5. MODIFICACIONES

En cualquier momento, el vendedor podrá realizar modificaciones en el diseño y la construcción de los productos, los componentes o las partes como el vendedor lo crea apropiado, sin previo aviso al comprador. El vendedor puede ofrecer sustitutos apropiados del material no disponible debido a las prioridades o normas establecidas por la autoridad gubernamental o la falta de materiales por parte de los proveedores.

6. GARANTÍA

El vendedor garantiza que cualquier utensilio de cocina suministrado en virtud del presente está libre de disconformidad con cualquier especificación adjunta y libre de defectos en los materiales y la calidad, que aparezcan en el plazo de 60 días. El vendedor también garantiza que cualquier equipo suministrado en virtud del presente está libre de disconformidad con cualquier especificación adjunta y libre de defectos en los materiales y la calidad, que aparezcan en el plazo de 18 meses desde la fecha de envío o 12 meses desde la fecha de compra por el usuario final, lo que ocurra antes. Si en dichos plazos cualquier producto pertinente se demuestra a satisfacción del vendedor que es defectuoso, la pieza afectada será reparada o sustituida sin cargo, bajo FCA destino original del comprador, o el vendedor devolverá el precio de compra de la parte afectada. La reparación, la sustitución o la devolución (lo que el vendedor determine, a su discreción) constituirá la única obligación del vendedor y el único remedio del comprador para cualquier deficiencia en los productos suministrados en virtud del presente, y estará condicionada por la devolución de dichos productos al vendedor por parte del comprador, bajo DDP muelle de carga del vendedor (según la definición de este último en Incoterms 2010). Cualquier pieza reparada o sustituida en virtud de esta garantía se garantiza solo durante el período restante de garantía sobre la pieza que ha sido reparada o sustituida. El vendedor no garantiza productos que hayan sido dañados por accidente, imprudencia, instalación indebida, configuración o supervisión (cuando proceda) inadecuadas o que hayan sido instalados o puestos en funcionamiento de cualquier modo que sea contrario a las instrucciones de instalación y funcionamiento. El vendedor no garantiza ningún servicio de reparación efectuado por personal no autorizado o agencias de servicios no autorizadas.

LAS GARANTÍAS ANTERIORES SON EXCLUSIVAS Y SUSTITUYEN TODAS LAS OTRAS ASEVERACIONES Y GARANTÍAS, EXPRESAS O IMPLÍCITAS; Y EL VENDEDOR NO ACEPTA Y EXCLUYE EXPRESAMENTE CUALQUIER GARANTÍA IMPLÍCITA DE COMERCIALIZACIÓN O IDONEIDAD PARA CUALQUIER PROPÓSITO PARTICULAR, Y CUALQUIER GARANTÍA QUE PUEDA SURGIR DE UN ACUERDO O USO COMERCIAL.

7. CANCELACIONES Y DEVOLUCIONES

Ningún pedido podrá ser cancelado ni modificado por el comprador excepto en virtud de los términos y condiciones que pueda aceptar el vendedor, tal como lo indique el consentimiento escrito del vendedor.

Se solicitará una autorización de devolución para todas las devoluciones.

SERECHAZARÁN las devoluciones de productos que no cuenten con la autorización previa por parte de la oficina del vendedor de Santa Coloma de Farners.

PUJADAS tiene libertad para autorizar y devolver y puede decidir rechazar la devolución según su propio criterio.

a. Las solicitudes de devoluciones de mercancía (que no sea mercancía defectuosa) deben efectuarse en el plazo de **90 DÍAS desde la FECHA DE LA FACTURA DE PUJADAS. DEBE INDICARSE EL NÚMERO DE ORDEN DE COMPRA o EL NÚMERO DE FACTURA DE PUJADAS** al solicitar la autorización. **NO SE EMITIRÁ NINGUNA AUTORIZACIÓN DE DEVOLUCIÓN a menos que se proporcione el número de orden de compra o el número de factura de Pujadas.**

b. Se aplicará un cargo por reposición de existencias como se indica a continuación: **Para cualquier devolución se cargará un 20%** del importe, por demérito y gestión, con un mínimo de 10 €.

c. Las devoluciones o los envíos de materiales a las instalaciones de PUJADAS para su pago, sustitución o reparación deberán efectuarse **siempre por flete prepagado.**

d. El número de autorización de la devolución deberá marcarse en todos los embalajes de los productos que se devuelvan.

e. Únicamente se aceptarán devoluciones de mercancía actual en su embalaje original, sin usar y en estado vendible. La mercancía devuelta que haya sido usada, esté obsoleta o desgastada se eliminará y NO se emitirá crédito.

1. La devolución de ESTANTERÍAS solo se efectuará si van en su embalaje completo, en palés si constan de más de un bulto y protegidas con film de plástico por encima.

2. La devolución de CARROS se efectuará en palés y con el embalaje protector completo.

f. Los siguientes productos no pueden devolverse: (1) utensilios de cocina a medida, (2) clips personalizados, (3) equipos personalizados. Tampoco se aceptará la devolución de materiales en los que PUJADAS haya efectuado alguna adaptación concreta para satisfacer el pedido.

8. PATENTES, MARCAS COMERCIALES Y COPYRIGHT

El vendedor, únicamente a su cargo, se defenderá de cualquier demanda realizada por cualquier persona contra el comprador por presunta violación de una patente de la Unión Europea, marca comercial o copyright relacionada con los productos o servicios ofrecidos por el vendedor en virtud del presente, y pagará cualquier indemnización por daños que se otorgue en firme, siempre y cuando el comprador haya realizado todos los pagos en virtud del presente y notifique por escrito al vendedor dicha demanda de inmediato, y transmita de inmediato al vendedor todas las notificaciones procesales y documentos recibidos, y permita al vendedor, a través de su abogado, defenderse de esta o resolverla, ya sea en nombre del comprador o del vendedor, y suministre toda la información, asistencia y autoridad necesarias para permitir al vendedor que así lo haga. Además, si el resultado de cualquier demanda es una resolución o un reconocimiento de infracción, el vendedor deberá, a elección del vendedor: (a) obtener para el comprador el derecho de continuar usando los bienes o productos o los servicios adquiridos del comprador, (b) sustituirlos con productos o servicios que no supongan ninguna infracción, (c), modificar dichos productos o servicios de manera que no supongan ninguna infracción, o (d) eliminar dichos bienes o productos o servicios y reembolsar al comprador la parte no devaluada del precio de compra, considerando una vida útil de cinco años.

En cuanto a los productos o servicios que el vendedor suministra al comprador fabricados partiendo de dibujos, diseños o especificaciones propuestas o suministradas por el comprador, el vendedor no será responsable y el comprador deberá indemnizar y eximir de responsabilidad al vendedor ante cualquier pérdida, responsabilidad, daño, reclamación y gasto (incluyendo sin limitación los honorarios razonables de los abogados del vendedor y otros costes de defensa) incurridos por el vendedor como resultado de una demanda por patente, marca comercial, copyright o violación del secreto comercial, o violación de otro derecho sobre la propiedad de terceros.

9. PERJUICIOS Y OTRA RESPONSABILIDAD; INDEMNIZACIÓN

La responsabilidad del vendedor respecto de los productos o servicios que se vendan en virtud del presente se limitará a la garantía y la indemnización establecidas en las secciones 7 y 9 de los presentes términos y condiciones de venta y, respecto de cualquier otro incumplimiento de su contrato con el comprador, se limitará al precio del contrato. **EL VENDEDOR NO ESTARÁ SUJETO A OTRA OBLIGACIÓN O RESPONSABILIDADES, YA SEA QUE SURJAN DE UN INCUMPLIMIENTO DE CONTRATO, GARANTÍA, ILÍCITO CIVIL (INCLUYENDO NEGLIGENCIA Y RESPONSABILIDAD POR HECHOS AJENOS) U OTRAS DOCTRINAS, RESPECTO DE LOS PRODUCTOS O LOS SERVICIOS OFRECIDOS POR EL VENDEDOR, O CUALQUIER EMPRENDIMIENTO, ACCIÓN U OMISIÓN RELACIONADA CON ESTOS.** Sin limitar el carácter general de lo antedicho, el vendedor específicamente rechaza cualquier responsabilidad por daños a la propiedad, multas, daños cuantificables o punitivos, daños por lucro cesante, inactividad, pérdida de clientela, coste de capital, coste de sustitución de productos o servicios, o cualquier otro tipo de pérdida de ventaja económica, o demandas de los clientes del comprador o de cualquier tercero por dichos daños, costes o pérdidas.

EL VENDEDOR NO SERÁ RESPONSABLE Y NO ACEPTA LA RESPONSABILIDAD POR PERJUICIOS, DAÑOS FORTUITOS, INDIRECTOS Y ACCIDENTALES DE CUALQUIER NATURALEZA.

El comprador eximirá y liberará al vendedor de cualquier pérdida, responsabilidad, daños y gastos (incluyendo sin limitación honorarios razonables de abogados y otros costes de defensa) en que pueda incurrir el vendedor como resultado de cualquier demanda del comprador, de los clientes del comprador o de cualquier tercero derivados de los productos y servicios que se vendan en virtud del presente o relacionados con estos, a menos que se determine en última instancia que dichas pérdidas, responsabilidades, daños o gastos son atribuibles únicamente a la conducta premeditada del vendedor.

10. PRECIOS

Los precios de venta son los que se especifican en nuestras tarifas, en referencia a la mercancía de nuestro almacén de Santa Coloma de Farners con embalaje de cartón no retornable.

11. FOTOGRAFÍAS, INFORMACIÓN Y MEDIDAS

Las fotografías, la información y las medidas indicadas en el catálogo del vendedor pueden sufrir cambios, sin previo aviso, debido a requisitos técnicos o de producción.

12. PROTECCIÓN DE DATOS PERSONALES

De conformidad con lo establecido en la normativa vigente en materia de protección de datos de carácter personal, VOLLRATH PUJADAS, S.A.U informa al comprador que los datos personales recogidos durante la relación comercial serán tratados e incorporados en los ficheros del vendedor, con el objetivo de poder prestar los servicios solicitados, así como también para mantenerlo informado de nuevos productos y servicios. Los datos facilitados se conservarán mientras se mantenga la relación comercial y una vez finalizada se conversarán aquellos que vengan exigidos por la legislación tributaria. En cualquier momento usted podrá ejercer los derechos de acceso, rectificación o supresión, limitación del tratamiento, portabilidad y oposición mediante una petición escrita a info@pujadas.es, acompañada de una fotocopia de su DNI/NIF. También podrá dirigirse a la Autoridad de Control competente para presentar la reclamación que considere oportuna.

Quedan reservados todos los derechos de cambio sin aviso previo, en especial colores o precios para los artículos que aparecen en este catálogo.

Fotografías no contractuales.

1. GOVERNING PROVISIONS

All sales by PUJADAS – A Vollrath Company (“Seller”) are subject to these terms and conditions, and are expressly conditioned upon assent to these terms and conditions. No additional or different terms or conditions will be binding upon Seller unless specifically agreed to in writing. Seller hereby objects to any such additional or different terms, and notifies buyer that Seller is unwilling to sell on any terms other than these terms and conditions. **Each contract of sale, including these terms and conditions shall constitute the entire agreement between Seller and buyer, and shall be governed by, construed and interpreted according to the laws of Spain, without reference to Principles of Conflicts of Laws. The rights and obligations of the Parties hereunder shall not be governed by the 1980 U.N. Convention on Contracts for the International Sale of Goods; and both parties hereby expressly submit to the jurisdiction of the Courts of Barcelona (Spain), in respect of any proceedings arising out of or in connection with the present General Selling Conditions.** There are no conditions affecting the parties’ agreement which are not expressed in these terms and conditions.

2. TAXES AND OTHER CHARGES

Any manufacturer’s tax, occupation tax, use tax, sales tax, excise tax, value added tax, duty, custom, inspection or testing fee, or any other tax, fee, interest or charge of any nature whatsoever imposed by any governmental authority on or measured by the transaction between Seller and buyer shall be paid by buyer in addition to the prices quoted or invoiced. In the event Seller is required to pay any such taxes or other charges, buyer shall reimburse Seller therefore on demand.

3. DELIVERY AND FREIGHT

All items are delivered FCA point of origin (Incoterms 2010). Except as provided below, orders made from the area of the Peninsula and the Balearic Islands with a value over 500 € (1,400 € in Canary Islands) or more shipping to one location will be shipped PREPAID by Seller. Orders with a value below 500 € will be assessed a 20 € freight charge. (55 € in Canary Islands). For ultimate destinations outside of Spain, all items are FCA Seller’s loading dock (as the latter shipping term is defined in Incoterms 2010). Delivery of products to the carrier shall constitute delivery to buyer; and regardless of shipping terms or freight payment, buyer shall bear all risk of loss or damage in transit. Seller reserves the right to make delivery in multiple shipments, unless otherwise expressly stipulated herein; all such shipments to be separately invoiced and paid for when due per invoice, without regard to subsequent deliveries.

Seller reserves ownership rights over all the materials supplied until full payment of the same.

a. Minimum Order Amount and Drop Ship Orders

A 6 € minimum order charge will apply to orders less than One Hundred Euro (100 €) NET. Seller reserves the right to refuse requests to drop ship orders for the same products to one or multiple locations.

b. Quantity

The materials will be supplied in complete packaging containing the quantity indicated in our rates.

c. Custom Smallwares

Custom Smallwares orders are completed with over/under shipments, not to exceed plus or minus 10% of the original order quantity.

4. CLAIMS, DELAYS AND FORCE MAJEURE

Under no circumstances shall claims concerning the condition of the merchandise or regarding shipping mistakes be accepted once 15 workdays have elapsed since the reception thereof.

Claims for shortages or other errors in delivery must be made in writing to Seller within 15 working days after receipt of shipment; and failure to give such notice shall constitute unqualified acceptance and a waiver of all such claims by buyer. **Claims for loss of or damage to goods in transit must be made to the carrier, and not to Seller. OUR RESPONSIBILITY FOR SHIPMENT CEASES WITH ACCEPTANCE BY CARRIERS.**

All delivery dates are approximate. Delay in delivery of any shipment shall not relieve buyer of its obligations to accept remaining shipments. Further, Seller shall not be liable for any losses or damages as a result of any delay or failure to deliver due to any cause beyond Seller’s reasonable control, including but not limited to any act of God, act of buyer, arrest or other governmental act, regulation or request, fire, accident, strike, slowdown, war, act of terrorism, riot, delay in transportation, or inability to obtain necessary labor, materials or manufacturing facilities. In the event of any such delay, the date of delivery shall be extended for a period equal to the time lost because of the delay. Buyer’s exclusive remedy for other delays and for Seller’s inability to deliver for any reason shall be rescission of its agreement to purchase.

5. CHANGES

Seller may at any time make such changes in design and construction of products, components or parts as Seller deems appropriate, without notice to buyer. Seller may furnish suitable substitutes for materials unobtainable because of priorities or regulations established by governmental authority or non-availability of materials from suppliers.

6. WARRANTIES

Seller warrants any smallwares provided hereunder to be free from nonconformity to any attached specifications, and free of defects in materials and workmanship, appearing within 60 days. Seller also warrants any equipment provided hereunder to be free from nonconformity to any attached specifications, and free of defects in materials and workmanship, appearing within 18 months from date of shipment or 12 months from date of purchase by the end user, whichever ends earlier. If within such periods any such applicable goods shall be proved to Seller’s satisfaction to be defective, the affected part will be repaired or replaced free of charge, FCA buyer’s original destination, or Seller will refund the purchase price of the affected part. Such repair, replacement or refund (whichever Seller determines, in its discretion, to provide) shall be Seller’s sole obligation and buyer’s exclusive remedy for any deficiency in goods furnished hereunder, and shall be conditioned upon buyer’s return of such goods to Seller, ., DDP Seller’s loading dock (as the latter shipping term is defined in Incoterms 2010). Any parts repaired or replaced under this warranty are warranted only for the balance of the warranty period on the part that was repaired or replaced. Seller gives no warranty on any goods damaged by accident, carelessness, improper installation, lack of proper setup or supervision (when required) or installed or operated in any manner contrary to the installation and operating instructions. Seller gives no warranty on any repair services performed by unauthorized personnel or unauthorized service agencies.

THE ABOVE WARRANTIES ARE EXCLUSIVE AND IN LIEU OF ALL OTHER REPRESENTATIONS AND WARRANTIES, EXPRESS OR IMPLIED; AND SELLER EXPRESSLY DISCLAIMS AND EXCLUDES ANY IMPLIED WARRANTY OF MERCHANTABILITY OR FITNESS FOR ANY PARTICULAR PURPOSE, AND ANY WARRANTIES ARISING FROM COURSE OF DEALING OR USAGE OF TRADE.

7. CANCELLATIONS AND RETURNS.

No order may be cancelled or altered by buyer except upon terms and conditions acceptable to Seller, as evidenced by Seller's written consent.

Return Authorizations must be requested for all returns. Product returned without prior authorization from Seller's Santa Coloma de Farners office **WILL BE REFUSED**. PUJADAS if free to authorize the return and can decide refuse the return by its free criterion.

- a. Requests for returns of merchandise (other than defective merchandise) must be made within **90 DAYS of the PUJADAS INVOICE DATE. PURCHASE ORDER NUMBER or PUJADAS INVOICE NUMBER MUST BE PROVIDED when requesting the authorization. NO RETURN AUTHORIZATION will be issued unless Purchase Order Number or PUJADAS Invoice Number is provided.**
 - b. **A restocking charge applies as follows:**
 - 1. Merchandise less than 50 € value – 10 € restocking charge.
 - 2. **Merchandise more than 50 € value - 20% restocking charge.**
 - c. The returns or shipments of materials to the facilities of PUJADAS whether for payment, replacement or repair should always be made **by prepaid freight**.
 - d. Return Authorization Number must be marked on all returned cartons.
 - e. **Returns accepted only on current merchandise found in original carton and in new and saleable condition. Merchandise returned that is used, obsolete or shelf-worn will be disposed of and credit WILL NOT be issued.**
 - 1. The return of SHELVING shall only be performed in complete packaging, on pallets if it is more than one packaging and with plastic film protection over the same.
 - 2. The return of TROLLEYS shall be made on pallets and with complete protective packaging.
 - f. The following items may not be returned: (1) Custom Smallware, (2) Personalized flaps or clips, (3) Custom Equipment
- Neither shall the return of materials be admitted in which PUJADAS has performed some specific adaptation to comply with the order.

8. PATENTS, TRADEMARKS AND COPYRIGHTS

Seller will, at its own expense, defend any suits that may be instituted by anyone against buyer for alleged infringement of any European Union patent, trademark or copyright relating to goods or services provided by Seller, and pay any final damage award therein, provided buyer shall have made all payments then due hereunder, shall give Seller immediate notice in writing of any such suit, shall transmit to Seller immediately upon receipt all processes and papers served upon buyer, and shall permit Seller, through its counsel, to defend or settle the same either in the name of buyer or in the name of Seller, giving Seller all needed information, assistance and authority to enable Seller to do so. Further, if the result of any such suit is a determination or acknowledgement of infringement, Seller shall, at Seller's option (a) obtain for buyer the right to continue to use the goods or products of the services purchased from Seller, or (b) replace the same with non-infringing goods or services, or (c) modify such goods or services so that they are non-infringing, or (d) remove such goods or products of services and refund to buyer the undepreciated portion of the purchase price, determined on the basis of a five-year useful life.

To the extent that any goods or services that Seller furnishes to buyer are manufactured in accordance with drawings, designs or specifications proposed or furnished by buyer, Seller shall not be liable, and buyer shall indemnify and hold harmless Seller from and against any and all losses, liabilities, damages, claims and expenses (including but not limited to Seller's reasonable attorneys' fees and other costs of defense) incurred by Seller as a result of any claim of patent, trademark, copyright or trade secret infringement, or infringement or any other proprietary rights of third parties.

9. CONSEQUENTIAL DAMAGES AND OTHER LIABILITY; INDEMNITY

Seller's liability with respect to the goods or services sold hereunder shall be limited to the warranty and indemnity provided in sections 7 and 9 of these terms and conditions of sale and, with respect to any other breaches of its contract with buyer, shall be limited to the contract price. **SELLER SHALL NOT BE SUBJECT TO ANY OTHER OBLIGATIONS OR LIABILITIES, WHETHER ARISING OUT OF BREACH OF CONTRACT, WARRANTY, TORT (INCLUDING NEGLIGENCE AND STRICT LIABILITY) OR UNDER OTHER THEORIES OF LAW OR EQUITY, WITH RESPECT TO GOODS OR SERVICES SOLD BY SELLER, OR ANY UNDERTAKINGS, ACTS OR OMISSIONS RELATING**

THERETO. Without limiting the generality of the foregoing, Seller specifically disclaims any liability for property damages, penalties, special or punitive damages, damages for lost profits or revenues, down-time, lost good will, cost of capital, cost of substitute goods or services, or for any other types of loss of economic advantage, or for claims of buyer's customers or any third party for any such damages, costs or losses.

SELLER SHALL NOT BE LIABLE FOR AND DISCLAIMS ALL CONSEQUENTIAL, INCIDENTAL, INDIRECT AND CONTINGENT DAMAGES WHATSOEVER. Buyer shall indemnify and hold harmless Seller from and against any and all losses, liabilities, damages and expenses (including but not limited to attorneys' fees and other costs of defense) that Seller may incur as a result of any claim by buyer or by buyer's customers or by any third party arising out of or in connection with the goods or services sold hereunder, unless such losses, liabilities, damages or expenses are ultimately determined to be attributable solely to the willful misconduct of Seller.

10. PRICES

The selling prices are those specified in our rates, in reference to the merchandise in our warehouse of Santa Coloma de Farners with non-returnable cardboard packaging.

11. PHOTOS, DATA AND MEASUREMENTS

The photos, **data and measurements in the Seller's catalogue are subject to change**, without prior notice, due to technical or production requirements.

12. PERSONAL DATA PROTECTION

In accordance with the provisions of current legislation on the Protection of Personal Data, VOLLRATH PUJADAS, S.A.U informs the buyer that the personal data collected during the commercial relationship will be processed and incorporated into the seller's files, with the aim of being able to provide the services requested, as well as to keep the buyer informed of new products and services. The data provided will be kept as long as the commercial relationship is maintained and, once it has ended, to meet those requests required under tax legislation. The buyer may, at any time, exercise the rights of access, rectification or erasure, restriction of processing, data portability and opposition by means of a written request to info@pujadas.es, accompanied by a photocopy of your DNI/NIF (National Identity Document/Tax Identification Number). You can also contact the competent Control Authority to submit any complaint that you consider appropriate.

All rights reserved to make changes, without prior notice to articles that appear in this catalogue, particularly in relation to colours and/or prices.

Photographs do not form part of the contract.

1. DISPOSITIONS APPLICABLES.

Toutes les ventes réalisées par PUJADAS – A Vollrath Company ("Le Vendeur") sont soumises à ces termes et conditions générales, et sont expressément conditionnées à l'acceptation de ces termes et conditions générales. Aucune modalité ou conditions générales différentes ou supplémentaires ne s'imposeront au Vendeur, sauf accord stipulé par écrit. Le vendeur s'oppose à l'ajout de modalités et de conditions différentes et informe l'acheteur que le Vendeur n'est pas disposé à vendre ses produits sous tout autre terme que ces termes et conditions.

Chaque contrat de vente, incluant ces termes et conditions constituera l'accord intégrale entre le Vendeur et l'acheteur, et sera régi par, et interprété conformément aux lois espagnoles, sans égard à aucun principe de conflit de lois. Les droits et obligations des Parties au contrat ne seront pas régis par la Convention 1980 des Nations Unies sur les Contrats de Vente Internationale de marchandise ; et les deux parties au contrat se soumettent expressément à la juridiction des tribunaux de Barcelone (Espagne) pour toute procédure découlant ou en relation avec les présentes conditions générales de vente. Il n'y a pas de conditions affectant l'accord entre les deux parties au contrat qui ne sont pas exprimés dans ces termes et conditions.

2. TAXES AND AUTRES FRAIS

Toute taxe de fabricant, taxe d'occupation, taxe d'utilisation, taxe de vente, taxe d'accise, taxe sur la valeur ajoutée, droit de douane, taxe d'inspection ou d'examen, ou toute autre taxe, frais, intérêts ou frais de quelque nature que ce soit imposés par une autorité gouvernementale ou mesures pour la transaction entre le Vendeur et l'acheteur doit être payé par l'acheteur en plus du prix estimé ou facturé. Dans l'éventualité où le Vendeur serait tenu de payer de telles taxes ou autres frais, l'acheteur devra les lui rembourser sur demande.

3. LIVRAISON ET FRET

Tous les articles sont livrés FCA point d'origine (Incoterms 2010). A l'exception des dispositions ci-dessous, les commandes effectuées depuis la péninsule et depuis les Iles Baléares avec une valeur supérieure à 500 € (1,400 € pour les îles Canaries) ou plus d'expéditions à un endroit seront expédiées PREPAID (PRÉPAYÉ) par le Vendeur. Les commandes d'une valeur inférieure à 500€ seront évaluées de frais de fret de 20€. (55€ aux Iles Canaries) Pour les commandes dont la destination finale est en dehors d'Espagne, les produits sont livrés FCA dock de chargement du Vendeur (ceci étant défini par les conditions d'expédition des Incoterms 2010). La livraison des produits au transporteur constituera la livraison à l'acheteur ; ce qui signifie qu'indépendamment des conditions d'expédition ou de paiement du fret, l'acheteur doit supporter tous les risques de perte ou de détérioration liés au transport. Le Vendeur se réserve le droit de procéder à la livraison en plusieurs envois, sauf si le contraire est expressément stipulé ci-inclus. Tous les envois multiples devront être facturés et payés séparément au moment de la facturation, sans tenir compte des livraisons ultérieures.

Le Vendeur se réserve le droit de propriété sur tous les produits fournis jusqu'au paiement complet de ces derniers.

a. Montant minimum de la commande et commandes Drop Ship

Des frais minimums de 6 € seront appliqués aux commandes inférieures à 100 € NET.

Le Vendeur se réserve le droit de refuser des demandes de dropshipping pour les mêmes produits à destination d'une ou plusieurs localités.

b. Quantité

Les matériaux seront fournis dans un emballage complet contenant la quantité indiquée dans nos tarifs.

c. Ustensiles personnalisés

Les commandes d'ustensiles personnalisés sont complétées avec des envois inférieurs ou supérieurs, ne dépassant pas plus ou moins 10% de la commande originale.

4. RÉCLAMATIONS, RETARDS ET FORCE MAJEURE

En aucun cas, les réclamations concernant l'état de la marchandise ou des erreurs de livraison ne seront acceptées une fois que 15 jours ouvrables se sont écoulés depuis leur réception.

Les réclamations pour manque de produits ou tout autre erreur de livraison doivent être faites par écrit au Vendeur dans les 15 jours ouvrables suivant la réception de la marchandise. L'omission de donner un tel avis constituera une acceptation sans réserve et une renonciation à toute réclamation ultérieure de l'acheteur. **Les réclamations pour perte ou détériorations sont à effectuer auprès du transporteur et non de l'acheteur. NOTRE RESPONSABILITÉ QUAND AU TRANSPORT CESSE APRÈS ACCEPTATION DU TRANSPORTEUR.**

Toutes les dates de livraison sont approximatives. Le retard d'une livraison ne libère pas l'acheteur de son obligation d'accepter les envois restants. En outre, Le Vendeur ne serait pas être tenu responsable des pertes ou des dégradations résultant d'un retard ou d'un défaut de livraison en raison de circonstances ou d'événements indépendants de la volonté du Vendeur, incluant sans s'y limiter tout acte de Dieu, d'actes émanant de l'acheteur, d'actes gouvernementaux, de règlements ou demandes, feu, accident, grève, ralentissement, guerre, acte de terrorisme, émeute, retard dans le transport, incapacité d'un travailleur, défaillance du matériel ou des installations du fabricant. En cas de retard, la date de livraison est prolongée pour une période égale au temps perdu en raison du retard. Le recours exclusif de l'acheteur pour d'autres retard et pour l'incapacité du Vendeur à livrer la marchandise peut être l'annulation du contrat d'achat.

5. MODIFICATIONS

Le Vendeur peut à tout moment effectuer des changements concernant la conception ou la construction des produits, des composants ou de pièces si le Vendeur les juge appropriés, sans le notifier à l'acheteur. Le Vendeur peut fournir des substituts appropriés pour les matériaux impossibles de se procurer à cause de priorités ou de règlements imposés par une autorité gouvernementale ou en cas de non disponibilité des matériaux auprès des fournisseurs.

6. GARANTIES

Le vendeur garantit que tous les produits fournis en vertu des présentes CGV sont exempts de non-conformité aux spécifications ci-jointes, et sans défauts de fabrications apparaissant dans les 60 jours. Le vendeur garantit également que tous les équipements fournis en vertu des présentes CGV sont exempts de non-conformité aux spécifications ci-jointes, et sans défauts de fabrications apparaissant dans les 18 mois suivant la date d'envoi ou dans les 12 mois suivant la date d'achat de l'utilisateur final, qui se termine plus tôt. Si au cours de ces périodes il était prouvé au Vendeur que les produits sont défectueux, la part correspondante serait remplacée gratuitement, FCA destination initiale de l'acheteur, ou le Vendeur rembourserait le prix d'achat de la part affectée. Une telle réparation, remplacement ou remboursement (que le Vendeur détermine et accepte à son gré) représente l'unique obligation du Vendeur et le recours exclusif de l'acheteur pour de tels défaut pour des produits fournis dans le cadre de ces conditions générales de vente, et est conditionné au retour des produits par l'acheteur au Vendeur, DDP au dock d'expédition du Vendeur (ceci étant défini par les conditions d'expédition des Incoterms 2010). Toute pièce réparé ou remplacé dans le cadre de cette garantie est garantie seulement sur le solde de la période de garantie de la pièce réparée ou remplacée. Le vendeur ne garantit aucun produit endommagé par accident, négligence, mauvaise installation, manque de maintenance (le cas échéant) ou installation ou utilisation contraires aux instructions d'installation et d'utilisation. Le vendeur n'offre aucune garantie sur les services de réparation effectués par du personnel non autorisé ou des agences non autorisées.

LES GARANTIES CI-DESSUS SONT EXCLUSIVES ET EN LIEU ET PLACE DE TOUTES AUTRES REPRESENTATIONS OU GARANTIES, EXPRESSES OU IMPLICITES, ET LE VENDEUR DECLINE ET EXCLUT TOUTE GARANTIE IMPLICITE DE QUALITE MARCHANDE OU D'ADAPTATION A UN USAGE PARTICULIER, ET TOUTE GARANTIE POUVANT DECOULER DE RAPPORTS D'AFFAIRES OU DE PRATIQUES COMMERCIALES.

7. RÉCILIATIONS ET RENVOIS

Ningún pedido podrá ser cancelado ni modificado por el comprador. Aucune commande ne saurait être annulée ou modifiée par l'acheteur excepté dans le cadre des termes et conditions acceptables pour le Vendeur, et avec le consentement écrit de ce dernier.

Des Autorisations de Renvoi doivent être sollicitées pour tout renvoi.

Les produits renvoyer sans autorisation préalable de la part des bureaux du Vendeur à Santa Coloma de Farners **SERONT REFUSÉS**. PUJADAS est libre d'autoriser le renvoi et peut décider de refuser le renvoi sur critères propres.

a. Les demandes de renvoi de marchandise (pour un motif autre que produits défectueux) doivent être faites dans **les 90 JOURS** suivant la DATE DE FACTURATION par PUJADAS. LE NUMÉRO DE COMMANDE ou LE NUMÉRO DE LA FACTURE DOIT ÊTRE FOURNI pour une demande d'autorisation. **AUCUNE AUTORISATION DE RENVOI ne sera émise si le numéro de commande ou le numéro de facture n'est pas fourni.**

b. Des frais de restockage s'appliquent de la façon suivante :

1. Marchandise d'une valeur inférieure à 50€ - 10 € de frais de restockage.
2. Marchandise d'une valeur supérieure à 50 € - 20% comme frais de restockage.

c. Les renvois ou les envois de produit à destination des installations de PUJADAS pour des raisons de paiement, de remplacement ou de réparation devraient toujours être effectués en fret payé d'avance.

d. Le Numéro de l'Autorisation de Retour doit être indiqué sur tous les cartons retournés.

e. Les renvois sont acceptés uniquement pour les produits actuels, trouvés dans leurs cartons d'origine, à l'état de neuf et pouvant être revendus. Les produits renvoyés, s'ils sont usés, obsolètes ou présentent des marques de manipulation seront éliminés et le crédit NE SERA PAS émis.

1. Le renvoi de RAYONNAGE devra uniquement être effectué dans son emballage complet, sur palette s'il s'agit de plus d'un emballage, et avec un film plastique protecteur autour de ce dernier.
2. Le renvoi de CHARIOTS doit être effectué sur palette et avec l'emballage de protection complet.

f. Les produits suivants ne peuvent pas être renvoyés : (1) Les ustensiles personnalisés, (2) Les rabats et les pinces personnalisés, (3) les équipements personnalisés.

Le renvoi de produits pour lesquels PUJADAS a dû faire des adaptations pour honorer une demande, ne se pas accepté non plus.

8. BREVETS, MARQUE DÉPOSÉE ET COPYRIGHTS

Le vendeur défendra, à ses frais, tout procès qui pourrait être engagé par un tiers contre l'Acheteur pour la présumée violation d'un brevet, d'une marque déposée ou d'un copyright de l'Union Européenne en relation avec des produits ou des services fournis par le Vendeur, et il paiera toute indemnité finale en cas de dommage et intérêts, à condition que l'Acheteur ait effectué tous les paiements dus, l'acheteur devra immédiatement informer par écrit le Vendeur d'une telle poursuite, il devra de façon immédiate transmettre au Vendeur et dès leur réception les procédures et les documents qui sont notifiés à l'acheteur et devra permettre au Vendeur, via son avocat, de défendre ou régler cette affaire soit au nom de l'acheteur soit au nom du Vendeur, en donnant au Vendeur toutes les informations nécessaires, l'assistance et l'autorité pour lui permettre de le faire. En outre si le résultat d'un tel procès est une condamnation ou la reconnaissance d'une infraction, le Vendeur devra, à l'option du Vendeur (a) obtenir pour l'acheteur le droit de continuer à faire usage des produits ou des services achetés au Vendeur ou (b) remplacer ces derniers par des produits ou des services non litigieux, ou (c) modifier ces produits ou ces services de façon à ce qu'ils ne soient plus litigieux, ou (d) retirer ces produits ou services et rembourser à l'acheteur une valeur inférieure au prix d'achat déterminé en se basant sur une durée de vie utile de 5 ans.

Dans la mesure où tous les produits ou services fournis à l'acheteur par le Vendeur sont fabriqués conformément aux dessins, aux plans ou aux spécificités proposés ou fournis par l'acheteur, le Vendeur ne sera pas responsable, et l'acheteur devra indemniser et décharger le Vendeur pour et contre toute sorte de perte, d'en-cours, de dommages et intérêts, de réclamations et de dépenses (notamment, mais sans s'y limiter les honoraires engagés par le Vendeur pour sa défense et les autres coûts liés à sa défense) engagés par le Vendeur à la suite d'une réclamation pour atteinte au brevet, à la marque déposée, au copyright ou à une atteinte au secret commercial, ou pour tout autre violation du droit de propriété d'un tiers.

9. DOMMAGES CONSÉCUTIFS ET AUTRES RESPONSABILITÉS ; INDEMNITÉ

La responsabilité du vendeur à l'égard des produits et des services vendus en vertu des conditions présentes est limitée aux garanties et aux indemnités prévues aux articles 7 et 9 des présentes conditions générales de vente et, en ce qui concerne tout autre manquement au contrat qu'il a avec l'acheteur, l'indemnité est limitée au montant du contrat. **LE VENDEUR N'EST SOUMIS A AUCUNE AUTRES OBLIGATIONS OU RESPONSABILITÉS, DECOULANT D'UNE VIOLATION DU CONTRAT, DE GARANTIES, DE TORTS (INCLUANT LES NEGLIGENCES OU LES RESPONSABILITÉS STRICTES) OU DANS LE CADRE D'AUTRES THÉORIES LÉGALES, RELATIVES AUX PRODUITS ET AUX SERVICES VENDUS PAR LE VENDEUR, OU TOUT AUTRE ENGAGEMENT OU OMISSION RELATIF EN CELA.**

Sans limiter la portée de ce qui précède, le vendeur décline expressément toute responsabilité pour les dommages matériels, les pénalités, les dommages spéciaux ou punitifs, les dommages pour la perte de profits ou de revenus, les pertes de temps, la perte de survaleur, le coût du capital, le coût de produits de substitution, ou pour tout autre perte d'un avantage économique ou pour les réclamations des clients de l'acheteur ou tout autre tiers pour de tels dommages, coûts ou pertes.

LE VENDEUR NE SERA PAS RESPONSABLE ET REJETTE TOUS LES DOMMAGES CONSÉCUTIFS, ACCESSOIRES, INDIRECTS ET ÉVENTUELS.

L'acheteur devra indemniser et décharger le Vendeur pour et contre toute sorte de perte, d'en-cours, de dommages et intérêts, et de dépenses (notamment, mais sans s'y limiter les honoraires engagés par le Vendeur pour sa défense et les autres coûts liés à sa défense) que le Vendeur peut encourir à la suite d'une réclamation de l'acheteur ou d'un client de l'acheteur ou d'un tiers découlant ou en relation avec les produits ou les services vendus selon les modalités des présentes, à moins que ces pertes, en-cours, dommages et intérêts ou dépenses ne soient finalement attribués uniquement à la seule faute intentionnelle du Vendeur.

10. PRIX

Les prix de ventes sont ceux détaillés dans nos tarifs, faisant référence à la marchandise de notre entrepôt de Santa Coloma de Farners avec des emballages en carton non consignés.

11. PHOTOS, DONNÉES ET DIMENSIONS

Les photos, données et dimensions présentes dans le catalogue du Vendeur sont susceptibles d'être modifiées, sans notification préalable, en raison d'exigences techniques ou de production.

12. PROTECTION DES DONNÉES PERSONNELLES

Conformément à ce qu'établit la réglementation en vigueur en matière de protection de données à caractère personnel, VOLLRATH PUJADAS, S.A.U informe l'acheteur que les données personnelles collectées durant la relation commerciale seront traitées et stockées dans les fichiers du vendeur dans le but de pouvoir offrir les services requis ainsi que pour le tenir informé de nouveaux produits et services. Les données fournies seront conservées tant que durera la relation commerciale et, une fois celle-ci terminée, seules seront conservées celles exigées par la législation fiscale. À tout moment, vous pourrez exercer les droits d'accès, rectification ou suppression, limitation de traitement, portabilité et opposition moyennant demande par écrit adressée à info@pujadas.es, accompagnée d'une photocopie de votre numéro de pièce d'identité/ numéro d'identification fiscale. Vous pourrez aussi vous adresser à l'autorité de contrôle compétente pour présenter la réclamation que vous jugerez pertinente.

Tous les droits de modification sans avis préalable sont réservés, en particulier les couleurs ou les prix des articles figurant dans ce catalogue.

Photographies non contractuelles.

1. RECHTSHINWEISE

Alle durch PUJADAS – Ein Unternehmen der Vollrath-Gruppe (im Folgenden "der Verkäufer") realisierten Verkäufe unterliegen diesen Geschäftsbedingungen und sind ausdrücklich gebunden an die Zustimmung zu diesen Bestimmungen und Bedingungen. Für den Verkäufer sind keine anderen Bestimmungen oder Zusatzbedingungen bindend, es sei denn, hierzu erfolgt eine explizite schriftliche Vereinbarung. Hiermit stimmt der Verkäufer keinerlei anderen Bestimmungen oder Zusatzbedingungen zu und teilt dem Käufer mit, dass er keine Verkäufe zu anderen als den hier aufgeführten Geschäftsbedingungen realisiert. **Jeder Kaufvertrag, einschließlich dieser Geschäftsbedingungen, bildet eine untrennbare Vereinbarung zwischen Verkäufer und Käufer, unterliegt den spanischen Gesetzen und wird dementsprechend ausgelegt und verstanden, ohne dass die Grundsätze über Gesetzeskonflikte Anwendung finden. Die Rechte und Pflichten der Parteien gemäß dieser Geschäftsbedingungen unterliegen nicht den Vereinbarungen der Vereinten Nationen über internationale Kaufverträge von Waren aus dem Jahr 1980, und mit diesen Geschäftsbedingungen unterwerfen sich beide Parteien für alle Gerichtsverfahren, die aus diesen Allgemeinen Geschäftsbedingungen oder mit diesen verbundenen Bedingungen entstehen könnten, ausdrücklich der Jurisdiktion und den Gerichten von Barcelona (Spanien).** Es existiert keine Bedingung, die die Vereinbarung der Parteien betrifft, die nicht in diesen Allgemeinen Geschäftsbedingungen ausgedrückt ist.

2. STEUERN UND ANDERE KOSTEN

Die Produktionssteuer, Belegsteuer, Nutzungssteuer, Verkaufssteuer, Verbrauchsteuer, Mehrwertsteuer, Gebühren, Kosten für Personalisierung, Prüfung oder Tests und alle anderen Steuern, Gebühren, Zinsen oder Kosten, die aufgrund der Transaktion zwischen dem Verkäufer und dem Käufer durch eine Regierungsbehörde auferlegt werden, werden vom Käufer bezahlt, ebenso wie die notierten oder in Rechnung gestellten Preise. Sollte der Verkäufer solche Steuern oder anderen Kosten übernehmen, muss der Käufer dem Verkäufer diese zurück erstatten.

3. LIEFERUNG UND TRANSPORT

Alle Produkte werden FCA Frei Frachtführer geliefert (Incoterms 2010). Mit den im Folgenden festgelegten Ausnahmen werden alle auf der iberischen Halbinsel und den Balearen vorgenommenen Bestellungen, die einen Wert von mehr als 500 € haben (1400 € auf den Kanaren) nach VORKASSE vom Verkäufer versandt. Sendungen mit einem Wert von weniger als 500 € werden mit Versandkosten in Höhe von 20 € (55 € auf den Kanaren) belegt. Alle Sendungen mit Lieferort außerhalb Spaniens unterliegen FCA Verladerampe Verkäufer (gemäß der Definition in Incoterms 2010). Die Auslieferung der Produkte an den Transporteur wird als Auslieferung an den Käufer verstanden, und unabhängig von den Transportbedingungen oder –kosten, übernimmt der Käufer alle Risiken für Transportschäden oder –verluste. Der Verkäufer behält sich das Recht vor, die Lieferung in mehrere Teilsendungen aufzuteilen, es sei denn, es wird hier ausdrücklich das Gegenteil bestimmt. Die Teilsendungen werden einzeln in Rechnung gestellt und zum auf der entsprechenden Rechnung ausgewiesenen Datum bezahlt, unabhängig von späteren Lieferungen. Der Verkäufer behält sich das Eigentumsrecht aller versendeten Materialien vor, bis diese vollständig bezahlt wurden.

a. Mindestbestellwert und Bestellungen mit Direktlieferung

Für Bestellungen unter dem 100 € NETTO wird eine Gebühr von 6 € erhoben. Der Verkäufer behält sich das Recht vor, Bestellungen. Der Verkäufer behält sich das Recht vor, Bestellungen mit Direktlieferung für dieselben Produkte an eine oder mehrere Adressen nicht zu akzeptieren.

b. Menge

Die Materialien werden in ihrer vollständigen Verpackung, die die in unseren Preisen angegebenen Mengen enthält, geliefert.

c. Küchenutensilien nach Maß

Die Materialien werden in ihrer vollständigen Verpackung, die die in unseren Preisen angegebenen Mengen enthält, geliefert.

4. REKLAMATIONEN, VERZÖGERUNGEN UND HÖHERE GEWALT

In keinem Fall werden Reklamationen in Bezug auf den Warenzustand oder Lieferfehler nach Ablauf von 15 Werktagen nach Erhalt der Ware akzeptiert.

Reklamationen von Materialfehlern oder anderen Mängeln bei der Lieferung müssen schriftlich innerhalb von 15 Werktagen nach Erhalt der Lieferung erfolgen, eine fehlende Reklamation bedeutet eine uneingeschränkte Annahme und den Verzicht auf jedwede Reklamation seitens des Käufers. **Reklamationen aufgrund von Verlust von oder Schäden an den Produkten während des Transports müssen an den Transporteur und nicht an den Verkäufer gerichtet werden. UNSERE HAFTUNG IN BEZUG AUF DIE LIEFERUNG ENDET MIT DER ANNAHME DER WARE SEITENS DES TRANSPORTEURS.**

Beim Lieferdatum handelt es sich um eine ungefähre Angabe. Eine Verzögerung jedweder Lieferung befreit den Käufer nicht von seiner Pflicht, die restlichen Lieferungen anzunehmen. Darüber hinaus haftet der Verkäufer nicht für Verluste oder Schäden, die sich aus Verzögerungen ergeben können, oder fehlende Lieferungen aus Gründen, die vernünftigerweise außerhalb der Kontrolle des Verkäufers liegen, einschließlich aber nicht beschränkt auf höhere Gewalt, Handlungen des Käufers, Embargo oder andere Handlungen, Richtlinien oder Anweisungen der Regierung, Brand, Unfall, Streik, Stillstand, Krieg, terroristische Akte, Unruhen, Transportverspätungen oder Unmöglichkeit, notwendige Arbeitskräfte, Materialien oder Produktionsstätten zu bekommen. Sollte eine Verzögerung dieser Art entstehen, wird die Lieferfrist um den aufgrund der Verzögerung verlorenen Zeitraum verlängert. Dem Käufer steht einzig die Möglichkeit einer Vertragsauflösung zur Verfügung, wenn eine Verzögerung aus anderen Gründen eintritt und der Verkäufer unfähig ist, die Lieferung zu realisieren.

5. ÄNDERUNGEN.

Der Verkäufer kann jederzeit nach seinem Ermessen Änderungen am Design und der Herstellung der Produkte, den Komponenten oder Teilen ohne Vorankündigung gegenüber dem Käufer vornehmen. Der Verkäufer kann geeigneten Ersatz für Material anbieten, das aufgrund von durch Regierungsbehörden festgelegte Prioritäten oder Richtlinien nicht verfügbar ist, oder wenn Zulieferer Materialien nicht liefern können.

6. GEWÄHRLEISTUNG

Der Verkäufer haftet dafür, dass alle gemäß diesen Geschäftsbedingungen gelieferten Küchenutensilien jedweder angefügten Spezifizierung entsprechen und keine Fehler in Bezug auf Materialien und Qualität innerhalb von 60 Tagen aufweisen. Der Verkäufer haftet ebenfalls dafür, dass alle gemäß diesen Geschäftsbedingungen gelieferten Geräte jedweder angefügten Spezifizierung entsprechen und keine Fehler in Bezug auf Materialien und Qualität innerhalb der ersten 18 Monate ab Lieferung oder 12 Monate ab Datum des Kaufs durch den Endkunden auftreten, je nachdem, welcher Zeitraum zuerst endet. Sollte sich der Verkäufer innerhalb dieser Fristen zufrieden stellend überzeugen können, dass ein Produkt fehlerhaft ist, wird das entsprechende Teil kostenlos repariert oder ersetzt mit FCA ursprünglicher Lieferort des Käufers oder der Verkäufer erstattet des Kaufpreis des betroffenen teils zurück. Reparatur, Ersetzung oder Rückgabe (was der Verkäufer nach seinem Ermessen bestimmt) stellt die einzige Pflicht des Verkäufers und das einzige Mittel des Käufers dar in Bezug auf alle Mängel an den gelieferten Produkten gemäß dieser Geschäftsbedingungen und ist bedingt durch die Rückgabe der Produkte an den Verkäufer seitens des Käufers mittels DDP Verladerampe Verkäufer (gemäß der Definition in Incoterms 2010). Alle im Rahmen dieser Gewährleistung reparierten oder ersetzten Teile erhalten ausschließlich die restliche Gewährleistungszeit des ersetzten oder reparierten Teils. Der Verkäufer haftet nicht für Produkte, die durch Unfall, Fahrlässigkeit, unsachgemäße Installation, unangemessene Konfiguration oder Überwachung (gegebenenfalls) beschädigt wurden, oder die auf eine Weise installiert oder in Betrieb genommen wurden, die nicht den Installations- oder Betriebsanweisungen entspricht. Der Verkäufer haftet nicht für Reparaturservices, die durch nicht autorisiertes Personal oder nicht autorisierte Serviceagenturen vorgenommen werden.

ESHANDELT SICH UM EINE AUSSCHLIEßLICHE GEWÄHRLEISTUNG, DIE ALLE ANDEREN VERSICHERUNGEN UND GEWÄHRLEISTUNGEN, OB AUSDRÜCKLICH ODER IMPLIZIT, ERSETZT, UND DER VERKÄUFER AKZEPTIERT KEINERLEI IMPLIZITE GEWÄHRLEISTUNG FÜR GEBRAUCHSTAUGLICHKEIT UND EIGNUNG FÜR JEDWEDEN BESONDEREN ZWECK ODER GEWÄHRLEISTUNGEN, DIE AUS KOMMERZIELLER VEREINBARUNG ODER NUTZUNG ENTSTEHEN KÖNNEN UND SCHLIEßT DIESE AUSDRÜCKLICH AUS.

7. STORNIERUNGEN UND RÜCKGABEN

Bestellungen können durch den Käufer weder storniert noch geändert werden, sofern dies nicht in den Bestimmungen und Bedingungen vorgesehen ist, die der Verkäufer akzeptiert hat, so wie in der schriftlichen Einverständniserklärung des Verkäufers aufgeführt.

Für alle Rückgaben muss eine Rückgabegenehmigung beantragt werden. Produktrückgaben, die keine vorherige Rückgabegenehmigung durch das Büro des Verkäufers in Santa Coloma de Farners besitzen, werden **ABGELEHNT**.

PUJADAS hat die Freiheit, zu genehmigen und zurückzugeben und kann die Rückgabe nach eigenem Ermessen ablehnen.

- a. Anträge auf Warenrückgabe (unbeschädigter Ware) müssen innerhalb einer Frist von **90 TAGEN ab RECHNUNGSDATUM VON PUJADAS** erfolgen. Bei der Antragstellung sollte die **BESTELLNUMMER** oder die **RECHNUNGSNUMMER VON PUJADAS** angegeben werden. Es werden keine **RÜCKGABEGENEHMIGUNGEN** ausgestellt, solange keine Angabe über die Bestellnummer oder die Rechnungsnummer von Pujadas erfolgt.
- b. Es wird eine Gebühr für Wiederauffüllung der Bestände wie folgt erhoben:
 - 1. Ware mit einem Wert unter 50 €: **10 € Gebühr für Wiederauffüllung der Bestände**.
 - 2. Ware mit einem Wert über 50 €: **20% Gebühr für Wiederauffüllung der Bestände**.
 - 3. Rückgaben oder Materialsendungen an die Installationen von PUJADAS für ihre Bezahlung, Ersetzung oder Reparatur müssen immer mit im Voraus bezahltem Transport erfolgen.
- c. Die Rückgabegenehmigungsnummer muss auf allen Verpackungen der Produkte, die zurückgegeben werden, markiert sein.
- d. Es werden ausschließlich Rückgaben von Waren in Originalverpackung, ungenutzt und in verkäuflichem Zustand akzeptiert. Zurückgegebene Ware, die benutzt wurde, die obsolet oder abgenutzt ist, wird eliminiert und es erfolgt **KEINE** Rückerstattung.
 - 1. Die Rückgabe von REGALEN kann nur in ihrer vollständigen Verpackung, auf Paletten, sollte es sich um mehr als ein Packstück handeln, und geschützt durch eine Plastikfolie erfolgen.
 - 2. Die Rückgabe von WAGEN erfolgt auf Paletten und mit vollständiger Schutzverpackung.
- e. **Folgende Produkte sind von einer Rückgabe ausgeschlossen: (1) Küchenutensilien nach Maß, (2) personalisierte Clips, (3) personalisierte Geräte.**

Ebenfalls von der Rückgabe ausgeschlossen sind Materialien, an denen PUJADAS konkrete Anpassungen vorgenommen hat, um der Bestellung zu entsprechen.

8. PATENTE, MARKEN UND COPYRIGHT

Der Verkäufer verteidigt sich, ausschließlich auf seine Kosten, gegenüber jedweder Klage, die jedwede Person gegen den Käufer wegen vermeintlicher Verletzung der Patentrechte der Europäischen Union, Marken- oder Copyright-Rechte anstrengt in Bezug auf die vom Verkäufer gemäß diesen Geschäftsbedingungen angebotenen Produkte oder Dienstleistungen und bezahlt jedwede Entschädigung, die rechtskräftig bewilligt wird, solange der Käufer alle Zahlungen gemäß dieser Geschäftsbedingungen geleistet hat, und dem Verkäufer schriftlich und unmittelbar über die Klage in Kenntnis setzt und dem Verkäufer über seinen Anwalt sofort alle Verfahrensmittelungen und erhaltenen Unterlagen übermittelt, und den Verkäufer über seinen Anwalt befugt, die Klage zu verteidigen oder sie zu lösen, sowohl im Namen des Käufers als auch im Namen des Verkäufers, und ihm alle notwendigen Informationen, Hilfestellungen und Befugnisse zukommen lässt, damit dem Verkäufer dies möglich ist. Wenn das Ergebnis einer Klage eine Auflösung oder die Einräumung eines Verstoßes ist, sollte der Verkäufer außerdem, nach eigenem Ermessen: (a) für den Käufer das Recht erhalten, die vom Verkäufer erworbenen Waren und Produkte oder Dienstleistungen weiterhin zu nutzen, (b) sie durch Produkte oder Dienstleistungen ersetzen, die keine Verstöße bedeuten, (c), die fraglichen Produkte oder Dienstleistungen so verändern, dass sie keinen Verstoß mehr bedeuten oder (d) die Waren oder Produkte oder Dienstleistungen entfernen und dem Käufer den nicht geminderten Kaufpreis erstatten, wobei von einer Lebenszeit von fünf Jahren ausgegangen wird.

In Bezug auf Produkte oder Dienstleistungen, die der Verkäufer dem Käufer auf Basis von Zeichnungen, Entwürfen oder Spezifizierungen, die vom Käufer erstellt wurden, liefert, übernimmt der Verkäufer keine Haftung und der Käufer muss den Verkäufer für alle Verluste, Schäden, Reklamationen und Kosten (einschließlich aber nicht darauf beschränkt der vernünftigen Honorare für Anwälte des Verkäufers und andere Verteidigungskosten), die dem Verkäufer aus Klagen wegen Patent-, Mar-

ken- und Copyrightrechtsverstößen, Verletzung des Geschäftsgeheimnisses oder Verletzung anderer Eigentumsrechte Dritter, entschädigen und den Verkäufer von aller Haftung entbinden.

9. SCHADENSERSATZ UND ANDERE HAFTUNGEN

Die Haftung des Verkäufers in Bezug auf Produkte und Dienstleistungen, die gemäß diesen Geschäftsbedingungen verkauft werden, ist begrenzt auf die Gewährleistung und Entschädigungen, die unter Punkt 7 bis 9 dieser Geschäftsbedingungen festgelegt sind. In Bezug auf jede andere Nichterfüllung des Vertrags begrenzt sich die Haftung des Verkäufers auf den Vertragspreis. **DER VERKÄUFER UNTERLIEGT IN BEZUG AUF DIE PRODUKTE UND DIENSTLEISTUNGEN, DIE ER ANBIETET, ODER DAMIT VERBUNDENEN UNTERNEHMUNGEN, HANDLUNGEN ODER UNTERLASSUNGEN KEINEN WEITEREN PFLICHTEN ODER HAFTUNGEN, UNABHÄNGIG DAVON, OB ES SICH UM VERTRAGS-, GEWÄHRLEISTUNGS- ODER DELIKTHAFTUNG (EINSCHLIEßLICH FAHRLÄSSIGKEIT UND GEFÄHRDUNGSHAFTUNG) ODER ANDERWEITIGE HANDELT.** Ohne den allgemeinen Charakter des oben stehenden einzuschränken, lehnt der Verkäufer jede Haftung für Schäden am Eigentum, Strafgeldern, quantifizierbare und strafende Schäden, Schäden für entgangenen Gewinn, Inaktivität, Verlust von Kunden, Kapitalkosten, Kosten für die Ersetzung von Produkten und Dienstleistungen oder jede andere Art von Verlust von wirtschaftlichen Vorteilen oder Klagen von Kunden des Käufers oder Dritten bezüglich dieser Schäden, Kosten und Verluste, ab.

DER VERKÄUFER HAFTET NICHT UND ÜBERNIMMT KEINE HAFTUNG FÜR SCHADENSERSATZ UND ZUFÄLLIGE, INDIREKTE UND DURCH UNFALL ENTSTEHENDE SCHÄDEN JEDWEDER ART.

Der Käufer nimmt den Verkäufer von allen Verlusten, Haftungen, Schäden und Kosten (einschließlich aber nicht darauf beschränkt der vernünftigen Honorare für Anwälte des Verkäufers und andere Verteidigungskosten), die dem Verkäufer als Ergebnis von Klagen des Käufers, Kunden des Käufers oder Dritten, die sich aus den Produkten und Dienstleistungen ableiten, die gemäß diesen Geschäftsbedingungen oder mit diesen verbunden verkauft werden, aus und befreit ihn davon, es sei denn, in letzter Instanz wird entschieden, dass diese Verluste, Haftungen, Schäden und Kosten ausschließlich einem bewussten Verhalten des Verkäufers zuzuschreiben sind.

10. PREISE

Die Verkaufspreise werden in unseren Tarifen unter Bezug auf die Ware in unseren Lagern in Santa Coloma de Farners mit Einwegverpackungen spezifiziert.

11. FOTOGRAFIEEN, INFORMATIONEN UND MASSE

Die im Katalog des Verkäufers angegebenen Fotografien, Informationen und Maße können ohne vorherige Ankündigung aufgrund von technischen oder produktiven Anforderungen Änderungen unterliegen.

12. DATENSCHUTZ

In Übereinstimmung mit der gültigen Richtlinie über den Schutz personenbezogener Daten informiert VOLLRATH PUJADAS S.A.U. den Käufer, dass die während der Geschäftsbeziehung übermittelten Daten in eine Datei des Verkäufers aufgenommen und verarbeitet werden, um die angefragten Dienste leisten zu können, sowie Informationen über neue Produkte und Dienstleistungen zur Verfügung zu stellen. Die übermittelten Daten werden gespeichert, solange die Geschäftsbeziehung andauert. Nach Ende der Geschäftsbeziehung werden die Daten, für welche die Steuergesetzgebung dies vorschreibt, weiterhin aufbewahrt. Sie können jederzeit Ihr Recht auf Zugriff, Änderung oder Löschung, Verarbeitungseinschränkung, Portabilität und Widerspruch wahrnehmen, indem Sie sich schriftlich an info@pujadas.es wenden und eine Kopie Ihres Personalausweises anfügen. Sie können sich außerdem an die zuständige Kontrollbehörde wenden und eine Reklamation einreichen, wenn Sie dies wünschen.

Alle Rechte auf Änderung ohne Vorankündigung, insbesondere bezüglich Farben oder Preise von Artikeln, die in diesem Katalog aufgeführt sind, sind vorbehalten.

Fotos gelten nicht verbindlich.

CTPUJADAS2022



8 421661 620222

**THE VOLLRATH COMPANY, L.L.C.
HEADQUARTERS**

1236 North 18th street
Sheboygan, WISCONSIN 53081-3201 USA
Customer Service; 920.459.4851
Fax. 920.459. 6537
Credit: 920.459.5387

**VOLLRATH PUJADAS SAU
EMEA**

Ctra. de Castanyet, 132
17430 Santa Coloma de Farners
(GIRONA) - SPAIN
Tel. +34 972 84 32 01
info@pujadas.es

VOLLRATH OF CHINA

VOLLRATH SHANGHAI TRADING LIMITED
29D, 855 South Pu Dong road
Shanghai, CHINA 200120
Tel. 86-21-50589580

VOLLRATH DE MEXICO S. DE R.L. DE C.V.

Periférico Sur edificio 2-C
Col. Santa María Tequepexpan
45601 Tlaquepaque, JALISCO MEXICO
Tel. (52) 333.133.6767 or (52) 333.133.6769
Fax. (52) 333.133.6768

www.vollrath.com

2021 The Vollrath Company L.L.C.
An ISO9001 Certified Company



Outperform every day.™

www.pujadas.es
www.pujadasgrill.com

